



C4

ATE Classic 2016

**Bremsen-Ersatzteilprogramm
Brake Parts Program**



Kompetenz und Aktualität

Competence and topicality

Besuch uns auf Facebook

Visit us at facebook



www.facebook.com/ATE

ATE Online-Katalog

ATE online-catalog



Noch aktuellere Informationen finden Sie im **Online-Katalog** von ATE. Hier werden die Kataloginformationen mindestens monatlich aktualisiert. Sie finden den ATE Online-Katalog in der Rubrik "Kataloge -> Ersatzteile online" im Internet auf unserer Homepage unter www.ate.de.

Even more current information you find in the **ATE online-catalog**. Here the spare part information are posted at least monthly. You find the ATE online-catalog in the column "Catalogs -> replacement parts" on the Internet on our homepage www.ate.de.

ATE wird mobil

ATE goes mobile



Das Produktportfolio des Bremsenspezialisten ATE ist jetzt auch mobil

über die Smartphonereihe von

Apple zu erreichen. Mit dieser Applikation können Anwender alle Produkte der Marke ATE auf vielfältige Weise suchen und identifizieren. Die Software steht kostenlos im App Store von Apple zum Download bereit. Sie kann über Suchbegriffe wie „ATE“ oder „Bremsen“ leicht gefunden und installiert werden.

The product range of brake specialists ATE is now also accessible on the move using smartphones from Apple. With this application, users can search for and identify all products belonging to the ATE brand in a number of different ways. The software is available for download free of charge in Apple's App Store. It can easily be found and installed using search terms such as "ATE" or "brakes".

Jetzt auch für iPad und Android
Now also for iPad and Android

ATE Werkzeugkatalog



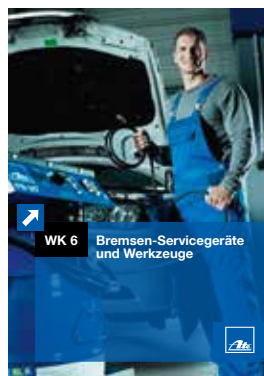





ATE Catalog Brake service equipment and tools

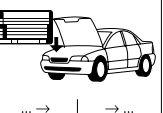

Die aktuelle Ausgabe heisst WK6 und ist zur Zeit in 7 Sprachen erhältlich.

The current edition called WK6 is by that time available in 7 languages.

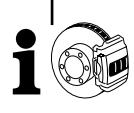
So benutzen Sie den C4

Fahrzeugtypen		Einbauzeitraum (von/bis)		ATE-Artikelnummer (lang)		Bemerkung (Artikel)		
Vorder-/Hinterachse	Fahrgestellnummer (von/bis)	Bemerkung (Fahrzeug)		ATE-Artikelnummer (kurz)		Artikeldefinition		
	kW							
								
	1,8 T 1,8 T Quattro 2,0 2,0 TFSI	◀ 120 ◀ 120 ◀ 96 ◀ 120	8E-55-999999 04.02 05.03 05.04	PR: 1LB,1LE PR: 1LB,1LE PR: 1LB,1LE PR: 1LB,1LE	11.3571-8522.2 11.3571-8521.2 11.0441-5704.2 11.0101-5409.2	220320 220319 250034 260035	+ ESP + ESP D=57, - Halter D=57, - Halter Dichtungssatz Hülsensatz	ATE ATE ATE ATE

*

**

*Produktgruppen

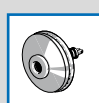

Bremskraftverstärker

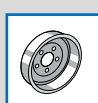

Bremstrommel



Hauptbremszylinder



ATE Original Kit
ATE Original TopKit



Ausgleichsbehälter



Trommelbremsbacken
für Feststellbremse



Bremssattel



Handbremsseil



Scheibenbremsbeläge

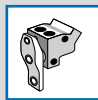

Bremskraftregler



Bremsscheibe
ATE PowerDisc



Kupplungs-
Geberzylinder



Bremsschlauch



Kupplungs-
Nehmerzylinder

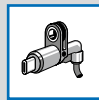

RadSENSOR



Kupplungsschlauch

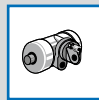

Radzylinder



Kupplungsseil



Trommelbremsbacken

**Lenkungsart

- ◀ Linkslenker
- ▶ Rechtslenker

****Herstellerkennung

ATE	Continental Teves (ATE)
AKE	Akebono
AP	AP Lockheed
BDX	Bendix
BOS	Bosch
BRE	Brembo
CIT	Citroën
DEL	Delco
FI	Fiat
FTE	FTE Automotive
LUC	Lucas (TRW)
PER	Perrot
SUM	Sumitomo
TOK	Tokico
VW	Volkswagen

Abkürzungen

-	Ohne / nicht	L	Legiert / hochgekoht
+	Mit / nur / für	L=	Länge
AUT	Automatische Nachstel- lung	Nz	Nehmerzylinder
B	Beschichtet	PD	PowerDisc
BG	Bremskraftbegrenzer	Rz	Radzylinder
BR	Bremskraftregler	RzR	Radzylinder mit integriertem Regler
BRE	Einschraubregler	S	Fixierschraube / Sattelschraube
BRES	Einschraubreglersatz	THz	Tandem-Hauptzylinder
BRL	Bremskraftregler lastabhängig	V	Belüftet
D=	Durchmesser	WE	Warneinrichtung
Gz	Geberzylinder	WK	Warnkontakt
HEB	Hebel	Zub	Zubehör
HZ	Hauptzylinder		

























***Einbauposition

- ☐ vorne
- ☐ hinten
- ☐ links
- ☐ rechts
- ☐ links vorne
- ☐ links hinten
- ☐ rechts vorne
- ☐ rechts hinten
- ☐ mitte
- ☐ oben
- ☐ unten
- ☐ Vorderachse
- ☐ Vorderachse links
- ☐ Vorderachse rechts
- ☐ Hinterachse
- ☐ Hinterachse links
- ☐ Hinterachse rechts

Sämtliche Positionsangaben
beziehen sich immer auf die
Fahrtrichtung.



Artikelinformationen

		KURZNUMMER				KURZNUMMER																					
	03.6199-xxxx.4 → 03.61dy-xxxx.4 → 03.67dy-xxxx.4 → 03.68dy-xxxx.4 → 03.69dy-xxxx.4 → 03.77dy-xxxx.4 →	30nnnn 30nnnn 30nnnn 30nnnn 30nnnn 30nnnn	Bremskraftverstärker T50 T51 T52/3 T52 T53 T52/4	<table border="1" data-bbox="550 369 790 582"> <tr> <td>d</td> <td>y</td> </tr> <tr> <td></td> <td>0 = Einfachgerät 5 = Tandemgerät</td> </tr> <tr> <td>2 = 6"</td> <td></td> </tr> <tr> <td>3 = 7"</td> <td></td> </tr> <tr> <td>4 = 8"</td> <td>0 = Einfachgerät</td> </tr> <tr> <td>5 = 9"</td> <td>3 = Einfachgerät BA</td> </tr> <tr> <td>6 = 10"</td> <td>5 = Einfachgerät</td> </tr> <tr> <td></td> <td>8 = Einfachgerät BA</td> </tr> <tr> <td></td> <td>BA = Bremsassistent</td> </tr> <tr> <td></td> <td>Z = Zugankerbremsgeräte</td> </tr> </table>	d	y		0 = Einfachgerät 5 = Tandemgerät	2 = 6"		3 = 7"		4 = 8"	0 = Einfachgerät	5 = 9"	3 = Einfachgerät BA	6 = 10"	5 = Einfachgerät		8 = Einfachgerät BA		BA = Bremsassistent		Z = Zugankerbremsgeräte		24.02dd-dxxx.x → 230/231 × 47	48nnnn Durchmesser / maximaler Durchmesser × Tiefe
d	y																										
	0 = Einfachgerät 5 = Tandemgerät																										
2 = 6"																											
3 = 7"																											
4 = 8"	0 = Einfachgerät																										
5 = 9"	3 = Einfachgerät BA																										
6 = 10"	5 = Einfachgerät																										
	8 = Einfachgerät BA																										
	BA = Bremsassistent																										
	Z = Zugankerbremsgeräte																										
	03.78dy-xxxx.4 → 03.78dy-xxxx.4 → 03.78dy-xxxx.4 → 03.78dy-xxxx.4 → 03.78dy-xxxx.4 → 03.78dy-xxxx.4 → 03.78dy-xxxx.4 →	30nnnn 30nnnn 30nnnn 30nnnn 30nnnn 30nnnn 30nnnn	T52/4 T52/4Z T52/5 T52/5Z T55/1 T55/1Z		▲ 03.27dd-xxxx.3 → ▲ 03.32dd-xxxx.3 → 03.040x-xxdd.2 → 03.0470-xxdd.2 →	02nnnn 02nnnn 06nnnn 06nnnn	einseitig wirkender Radzylinder Radzylinder Reparatur-Satz (mit Kolben) Dichtungs-Satz (ohne Kolben)																				
	03.78dy-xxxx.4 → 03.78dy-xxxx.4 → 03.78dy-xxxx.4 → 03.78dy-xxxx.4 → 03.78dy-xxxx.4 → 03.78dy-xxxx.4 →	30nnnn 30nnnn 30nnnn 30nnnn 30nnnn 30nnnn	T52/4 T52/4Z T52/5 T52/5Z T55/1 T55/1Z		03.0137-0xxx.2 → 03.0137-9xxx.2 →	650xxx 669xxx	Trommelbremsbacken Bremsbacken-Zubehör																				
	▲ 03.20dd-xxxx.3 → ▲ 03.21dd-xxxx.3 → ▲ 03.23dd-xxxx.3 → ▲ 03.31dd-xxxx.3 → 03.0370-xxdd.2 →	01nnnn 01nnnn 01nnnn 01nnnn 05xxdd	Tandem-Hauptzylinder gestuft Tandem-Hauptzylinder Stufen-Hauptzylinder Hauptzylinder (z. B. 03.2122-: Ø=22,20) Reparaturatz		185 × 31 AUT HEB Zub		Durchmesser × Breite mit automatischer Nachstellung mit Hebel mit Zubehör																				
	03.3508-xxxx.x → 03.3509-xxxx.x → 03.3558.0xxx.x → 03.0101-xxxx.2 →	31nnnn 31nnnn 31nnnn 39nnnn	Ausgleichsbehälter Ausgleichsbehälter Ausgleichsbehälter Reparaturatz		03.0420-xxdd.3 → 03.0520-xxdd.3 →	68xxdd 69xxdd	ATE Original Kit ATE Original TopKit (Radzylinder + Trommelbrems- backen + Einbausatz) dd = Nennmaß Radzylinder																				
	▲ 11.3ddx-xxxx.2 → 11.9ddx-xxxx.2 → ▲ 13.2ddx-xxxx.2 → ▲ 13.4ddx-xxxx.2 → 13.9ddx-xxxx.2 → 24.3ddx-xxxx.5 → 11.0441-ddxx.2 → 13.0441-ddxx.2 → 11.0230-xxxx.2 → 24.0101-xxxx.2 → ▲ 11.0101-xxxx.2 → 11.8116-xxxx.1 →	22nnnn 22nnnn 21nnnn 21nnnn 21nnnn 24nnnn 25nnnn 25nnnn 26nnnn 26nnnn 26nnnn 39nnnn	Faustsattel Faustsattel 2-Zyl. Festsattel 4-Zyl. Festsattel Festsattel Austauschsattel Faustsattel Dichtungs-Satz Dichtungs-Satz Faustsattelhalter-Satz (Halter, Schiebehülzensatz, Führungsbolzen) Bremsattel-Zubehör (Schiebehülzensatz, Führungsbolzen) Schiebehülzensatz Haltefeder		03.0137-0xxx.2 → 03.0137-9xxx.2 →	650xxx 669xxx	Feststellbremse (Trommelbremsbacken) Einbausatz																				
	13.0460-xxxx.2 → 13.0460-0xxx.2 → 24.8190-xxxx.2 →	60xxxx 610xxx 62xxxx	Scheibenbremsbelag Belagsatz-Zubehör Warnkontakt		24.3727-xxxx.2 →	58xxxx	Handbremsseil																				
	20034 15,0 + WE WK S Zub		WVA-Nummer / Dicke weitere WVA-Nummern siehe Anhang Warneinrichtung mit Warnkontakt mit Sattelschraube mit Zubehör		83.5yxx-LLLL.3 → 83.6yxx-LLLL.3 → 83.7yxx-LLLL.3 →	33nnnn 33nnnn 33nnnn	Brems-/Kupplungsschlauch Brems-/Kupplungsschlauch Brems-/Kupplungsschlauch y = 1: Gewinde 1 × innen/1 × außen y = 2: Gewinde 2 × innen y = 3: Gewinde 2 × außen																				
	13.0460-xxxx.2 → 13.0460-0xxx.2 → 24.8190-xxxx.2 →	60xxxx 610xxx 62xxxx	Scheibenbremsbelag Belagsatz-Zubehör Warnkontakt		03.60xx-xxxx.3 → 03.65xx-xxxx.3 → 03.0101-xxxx.2 →	32nnnn 32nnnn 32nnnn	Bremskraftregler (BR) Bremskraftbegrenzer (BG) Einschraubregler (BRE) Bremskraftregler lastabhängig (BRL) Einschraubregler-Satz (BRES)																				
	20034 15,0 + WE WK S Zub		WVA-Nummer / Dicke weitere WVA-Nummern siehe Anhang Warneinrichtung mit Warnkontakt mit Sattelschraube mit Zubehör		35/3 braun (4)		Kennzeichen, Farbmarkierung (Anzahl der Anschlüsse)																				
Bremsbelagsätze haben eine Allgemeine Betriebslaubnis (ABE) oder eine Homologation nach ECE-R90, bzw. kommen aus derselben Fertigung und unterliegen derselben Qualitätssicherung wie der vom Fahrzeughersteller vorgesehene Belag.					▲ 03.24dd-xxxx.3 → 03.0350-ddxx.2 →	03nnnn 07ddxx	Kupplungs-Geberzylinder (z. B. 03.2419-: Ø=19,05) Dichtungs-Satz																				
	24.01dd-xxxx.x → 24.03dd-xxxx.x →	4ddxxx 5ddxxx	Bremsscheibe ATE PowerDisc dd = Dicke (z.B. 24.0322- : Dicke = 22)		▲ 03.25dd-xxxx.3 → 03.0450-ddxx.2 →	04nnnn 08ddxx	Kupplungs-Nehmerzylinder (z. B. 03.2525-: Ø=25,40) Dichtungs-Satz																				
	284 22 20 V L PD B V L S PD		Durchmesser / Dicke / Mindestdicke beschichtet belüftet legiert / hochgekocht Fixierschraube ATE PowerDisc		24.3728-xxxx.2 →	59xxxx	Kupplungsseil																				
					24.07xx-xxxx.x →	36nnnn	Radsensor																				

nnnn = Die letzten vier Ziffern entsprechen einer Zählnummer.

dd = Nennmaß

▲ Auch 24. bei gleicher Benummerungssystematik möglich.

■ Auch 03., 24. und 83. bei gleicher Benummerungssystematik möglich.

Nachdruck, auch auszugsweise, nur mit unserer Genehmigung gestattet. Ersatzansprüche auf Grund von Angaben in diesem Katalog können nicht anerkannt werden. Konstruktionsänderungen vorbehalten. Soweit wir in unseren Unterlagen Bezug nehmen auf die Ersatzteilnummer des Fahrzeugherstellers, dient dies nur zu Vergleichszwecken. Eine Verwendung derartiger Angaben in Rechnungen an den Fahrzeugbesitzer ist nicht statthaft.

Die Modell- und Ersatzteilmultifalt einiger Fahrzeughersteller erlaubt nicht immer eine genaue Zuordnung. Bitte beachten Sie daher besonders die im Katalog aufgeführten Bemerkungen und Ersatzteilbeschreibungen.

C4

(D) Inhaltsverzeichnis

ATE Classic	2
Bremsflüssigkeit	4
Fahrzeugregister	7
Fahrzeugverwendungen	12
Abmessungen Bremsscheiben	469
Armaturen	515
Bremsgeräte komplett	531
Reparatursätze	559
Vergleichsliste	587
Technische Übersetzungen	633
So benutzen Sie den C4	643

(EN) Table of contents

ATE Classic	2
Brake fluid	4
Index of vehicles	7
Applications of vehicles	12
Dimensions brake discs	469
Fittings	515
Booster units complete	531
Repair kits	559
Cross reference list	587
Technical translations	633
How to use the C4	643

(FR) Table des matières

ATE Classic	2
Liquides de frein	4
Liste des véhicules	7
Applications	12
Dimensions Disques de frein	469
Composants et accessoires	515
Servo-freins complets	531
Nécessaires de réparation	559
Liste des correspondances	587
Traductions techniques	633
Utilisation du catalogue C4	643

(ES) Índice

ATE Classic	2
Líquido de freno	4
Índice de vehículos	7
Aplicaciones	12
Medidas disco de freno	469
Assesorios	515
Servofreno completo	531
Juegos de reparación	559
Lista comparativa WVA	587
Traducciones técnicas	633
Use así el C4	643

ATE Classic – Teile und Service

Originalgetreue Bremseninstandsetzung
für Old- und Youngtimer

Wir lieben Oldies

Old- und Youngtimer wecken Emotionen. Sie werden liebevoll restauriert und gepflegt. Denn sie sollen ihren Besitzern möglichst lange erhalten bleiben. Neben dem optischen Anspruch sollen sie natürlich auch sicher im Straßenverkehr unterwegs sein. Hierzu brauchen sie vor allem intakte Bremsen.

Originalgetreue Bremseninstandsetzung

Mit der neuen Produktfamilie ATE Classic unterstützen wir von Continental Freunde klassischer Automobile bei der professionellen und originalgetreuen Bremseninstandsetzung. ATE Classic bietet ein breit gefächertes Programm an Bremsenersatzteilen speziell für Old- und Youngtimer. Zudem gibt es unter dem neuen Produktnamen Classic einen zielgruppenorientierten Service für das Beschaffen rar gewordener Komponenten von Bremssystemen.

Nachschlagewerk für Bremsenersatzteile

In unserem neuen ATE Classic Katalog finden Fachleute ein breites Spektrum verfügbarer Bremsenersatzteile. Dieses Programm haben wir speziell für Pkw und Nkw zusammengestellt, die älter sind als 20 Jahre. Das ATE Classic Programm umfasst alle Produktgruppen innerhalb des Bremssystems und reicht von Verschleißteilen bis hin zu mechanischen und hydraulischen Betätigungskomponenten.

Besonderer Service für besondere Fahrzeuge

Sollte ein Bremsenersatzteil nicht im ATE Classic Katalog zu finden sein, können Sie sich mit Hilfe eines Anfrageformulars unter www.ate-classic.de direkt an unsere ATE Classic Vertriebs-Spezialisten wenden. Wir prüfen, ob das benötigte Ersatzteil im Lager verfügbar ist oder neu produziert werden kann. Darüber hinaus beraten wir Sie über technisch gleichwertige Alternativen und geben Hinweise auf mögliche Bezugsquellen.

Klassik-Kompetenz steigern - neue Kunden gewinnen

Die Marke ATE hat eine lange Tradition in der Automobilgeschichte. Schon seit mehr als hundert Jahren entwickelt und produziert ATE innovative Bremssysteme. Zahlreiche wegweisende Entwicklungen in der Bremsentechnik sind auf das Know-how von ATE zurückzuführen. Mit ATE Classic bündeln wir von Continental im Automotive Aftermarket nun diese Erfahrungen und helfen Ihnen, den Fachleuten aus Handel und Kfz-Werkstätten, ihre Klassik-Kompetenz auszubauen. Zudem öffnet ATE Classic den Zugang zu neuen Kundengruppen.



ATE Classic: Vorteile im Überblick

- umfangreiches Produktprogramm – speziell für Pkw und Nfz, die älter sind als 20 Jahre
- Übersichtlicher ATE Classic Katalog
- schnelle Lieferung der im Katalog gelisteten Ersatzteile über den Fachhandel
- Verfügbarkeit des ATE Classic Programms in elektronischen Teilekatalogen (TecDoc)
- sichere und originalgetreue Bremsenreparatur dank ATE Bremsenersatzteilen in OE-Qualität
- Beratung über technisch gleichwertige Alternativen
- Hilfestellung beim Beschaffen vergriffener Ersatzteile

ATE Classic – parts and service

Brake repairs with authentic parts for classic
and near-classic cars



We love classic cars

Classic cars – and those that are on the way to becoming classics – evoke strong emotions. They are restored and maintained with loving care, and their owners want to keep them in top condition for as long as possible. While preserving a first-rate appearance is an important goal, these cars must be safe on the road as well. And that means having effective brakes.

Brake repairs with authentic parts

Continental's new ATE Classic product family allows classic car enthusiasts to carry out professional brake repairs with parts that match the originals. ATE Classic provides an extensive line of replacement parts suited especially for classic and near-classic cars. In addition, the new Classic service helps owners to procure brake system components that have become hard to find.

Reference work for replacement brake parts

Our new ATE Classic catalog offers professionals a wide range of replacement parts for brakes. We've put together this selection especially for cars and commercial vehicles that are over 20 years old. The ATE Classic product family includes all brake system product groups, from wear parts all the way up to mechanical and hydraulic actuation components.

A special service for special vehicles

If you do not find a particular replacement part in the ATE Classic catalog, you can contact our ATE Classic sales specialists directly using a query form at www.ate-classic.com. We'll check whether we have the part in stock and, if not, whether we can produce a new one. Moreover, we'll advise you on alternatives that are equally effective from a technical standpoint and tell you where you can obtain them.

Enhance your classic car expertise and win new customers

The ATE brand has a longstanding reputation in the automotive industry. For more than one hundred years, ATE has developed and manufactured innovative brake systems, introducing many groundbreaking advances. Now, with ATE Classic, Continental has brought all this experience together. ATE Classic will help you as a dealer or repair facility to enhance your expertise in classic cars, enabling you to gain access to new customer groups.



ATE Classic: summary of the advantages

- Extensive product range geared to cars and commercial vehicles over 20 years old
- Easy-to-use ATE Classic catalog
- Quick delivery, via specialist dealers, of spare parts listed in the catalog
- Availability of ATE Classic products in electronic parts catalogs (TecDoc)
- Reliable brake repairs that are true to the original, using ATE spare parts in OEM quality
- Advisory service for finding equally effective alternatives
- Support in procuring spare parts that are no longer on the market
- Enhancement of classic car expertise for dealers and repair facilities, thus providing access to new customer groups
- Further information at www.ate-classic.com

Die richtige Wahl für mehr Sicherheit

The right choice for greater safety

ATE bietet Ihnen die richtige Bremsflüssigkeit für jede Anforderung und Gebindegröße:
ATE has the right brake fluid for you, whatever the requirement or container size:

	Bremsflüssigkeit/ Brake fluid	Siedepunkt mind./ Minimum boiling point	Nass-Siede- punkt mind./ Mi- nimum wet boiling point	Viskosität bei -40 °C/ Viscosity at -40 °C	Wechsel- intervall/ Replacement interval
Für Fahrzeugbaujahre bis ca. 1990/ For vehicles built up to around 1990	 <p>ATE G DOT 3 Unsere Traditionsreiche! Steeped in tradition!</p>	245 °C	150 °C	max. 1.500 mm ² /s	bis 1 Jahr up to 1 year
	 <p>ATE SL DOT 4 Millionenfach bewährte DOT 4- Qualität DOT 4 quality, proven a million times over</p>	260 °C	165 °C	max. 1.400 mm ² /s	bis 1 Jahr up to 1 year
Für Fahrzeugbaujahre ab ca. 1990/ For vehicles built from around 1990	 <p>ATE SL.6 DOT 4, ISO CLASS 6 Niedrigviskose Flüssigkeit für elektronische Bremssysteme Low-viscosity fluid for electronic braking systems</p>	265 °C	175 °C	max. 700 mm ² /s	bis 2 Jahre up to 2 years
	 <p>ATE TYPE 200 DOT 4 New racing quality Minimaler Siedepunkt- abfall durch hervorragendes Wasser- bindungsvermögen Minimum fall-off in boiling point thanks to outstanding water- binding capacity</p>	280 °C	198 °C	max. 1.400 mm ² /s	bis 3 Jahre up to 3 years

Zur Erhaltung der Funktionssicherheit der Bremsanlage muss Bremsflüssigkeit entsprechend der vom Fahrzeughersteller vorgegebenen Qualität und den Wechselintervallen gewechselt werden. Weitere Details erhalten Sie im Internet unter www.ate.de
 To maintain the operational reliability and safety of the brake system, you must change the brake fluid in accordance with the vehicle manufacturers' recommendations on quality and replacement intervals. You will find more details on the Internet under www.ate.de

Bremsflüssigkeiten für jeden Bedarf

Brake fluids for every need

Typ Type	ATE Sachnummer ATE partnumber	EAN-Nr. 4006633 EAN-No. 4006633	Gebinde Container size	Paletteneinheit* Pallet units*	
G	SAE Spezifikation J1703-FMVSS 116/DOT 3	705302 03.9901-5302.2/02	10199 8	1l	D
		705303 03.9901-5303.2/02	10201 8	5l	F
		größere Gebinde auf Anfrage - Bigger container sizes on demand			
SL	SAE Spezifikation J1704-FMVSS 116/DOT 4	705808 03.9901-5808.2/02	49000 9	1/4l	A
		705801 03.9901-5801.2/02	49001 6	1/2l	B
		705802 03.9901-5802.2/02	49002 3	1l	D
		705803 03.9901-5803.2/02	49003 0	5l	F
		705811 03.9901-5811.2/02	29907 7	20l	R
		705820 03.9901-5820.2/01	10824 9	30l	H
		705814 03.9901-5814.2/01	10366 4	50l	P
		705805 03.9901-5805.2/01	49005 4	200l	S
		706408 03.9901-6408.2/02	22762 9	1/4l	A
		706402 03.9901-6402.2/02	20746 1	1l	D
SL.6 NEW	SAE Spezifikation J1704-FMVSS 116/DOT 4 ISO Klasse 6 - niedrigviskos	706403 03.9901-6403.2/02	20748 5	5l	F
		706411 03.9901-6411.2/02	20750 8	20l	R
		706420 03.9901-6420.2/02	23120 6	30l	H
		706414 03.9901-6414.2/02	23005 6	50l	P
		706405 03.9901-6405.2/02	23121 3	200l	S
		706202 03.9901-6202.2/02	10825 6	1l	D
		706203 03.9901-6203.2/02	12166 8	5l	F
		706220 03.9901-6220.2/01	12780 6	30l	H
		706214 03.9901-6214.2/01	12779 0	50l	P
		706205 03.9901-6205.2/01	12778 3	200l	S
TYP 200 New racing quality	SAE Spezifikation J1704-FMVSS 116/DOT 4	706020 03.9901-6020.2/01	14544 2	30l	H
		706005 03.9901-6005.2/01	07769 9	200l	S
		700009 03.9902-0501.2/02	13536 8	180 g	L
		700010 03.9902-0503.2/01	13532 0	5 kg	K
		700011 03.9902-0504.2/01	13530 6	40 kg	P
		700002 03.9902-0116.2/02	10374 9	5 l	F
		700014 03.9902-1001.2/02	05176 7	35 ml	I
		700015 03.9902-1002.2/02	05184 2	75 ml	J
		740169 03.9302-1474.1/01	07782 8	25 l	S
		760070 03.9314-5940.3/01	07786 6	1 St.	S
SUPER DOT 4	SAE Spezifikation J1704-FMVSS 116/DOT 4	760153 03.9314-5960.3/02	30855 7	1 St.	S
ATE Bremszylinder-Paste ATE Brake Cylinder Paste					
ATE Prüfflüssigkeit ATE Testing Fluid					
ATE plastilube™					
ATE Leerkanne ATE neutral empty container					
Ausgiesser für 5-l-Kanne Spout for 5l container					
Kannen-Auslass-Hahn für 5-l-und 20-l-Kanne Tap for 5l and 20l tin					

*Paletteneinheit:

A	= 1.728 Kannen je Palette	(24 Kannen je Karton)
B	= 1.200 Kannen je Palette	(20 Kannen je Karton)
D	= 600 Kannen je Palette	(10 Kannen je Karton)
E	= 360 Kannen je Palette	(10 Kannen je Karton)
F	= 144 Kannen je Palette	(4 Kannen je Karton)
G	= 50 Kannen je Palette	
H	= 22 Kannen je Palette	
I	= 5.040 Tuben je Palette	(24 Tuben je Karton)
J	= 1.728 Tuben je Palette	(12 Tuben je Karton)
K	= 60 Eimer je Palette	
L	= 1.800 Tuben je Palette	(40 Tuben je Karton)
M	= 18 Kannen je Palette	
N	= 300 Kannen je Palette	(10 Kannen je Karton)
O	= 64 Kannen je Palette	(4 Kannen je Karton)
P	= 12 Kannen je Palette	
R	= 36 Kannen je Palette	
S	= 1 Stück	

*Pallet units:

A	= 1.728 containers per pallet	(24 containers per box)
B	= 1.200 containers per pallet	(20 containers per box)
D	= 600 containers per pallet	(10 containers per box)
E	= 360 containers per pallet	(10 containers per box)
F	= 144 containers per pallet	(4 containers per box)
G	= 50 containers per pallet	
H	= 22 containers per pallet	
I	= 5.040 tubes per pallet	(24 tubes per box)
J	= 1.728 tubes per pallet	(12 tubes per box)
K	= 60 buckets per pallet	
L	= 1.800 tubes per pallet	(40 tubes per box)
M	= 18 containers per pallet	
N	= 300 containers per pallet	(10 tubes per box)
O	= 64 containers per pallet	(4 containers per box)
P	= 12 containers per pallet	
R	= 36 containers per pallet	
S	= 1 piece	



A large rectangular area containing 30 horizontal lines, intended for writing or drawing.





Ⓛ **Fahrzeugregister**

Ⓛ **Index of vehicles**

Ⓛ **Liste des véhicules**

Ⓛ **Índice de vehículos**

**ALFA ROMEO**

6 (79-86)	14
33 (83-89)	14
33 (90-94)	14
75 (86-92)	15
90 (84-87)	16
164 (87-91)	16
1300 GT Junior / 2000 GTV (66-79)	17
1750 (68-72)	17
ALFASUD (71-84)	18
ALFETTA (72-84)	18
AR 6 (85-89)	18
AR 8 (78-89)	19
ARNA (83-87)	19
GIULIA (62-78)	19
GIULIETTA (77-85)	20
GTV (81-87)	20
MONTREAL (70-74)	21
R.Z. SPEEDSTER (92-93)	21
SPIDER (68-93)	21
SPRINT (76-89)	22
S.Z. COUPE (89-92)	22

AUDI

50 (74-78)	22
60/75/80/90 (65-73)	23
80 (72-78)	23
80 (79-81)	24
80 (82-84)	25
80 (84-87)	27
80 (87-91)	28
80 (91-95)	30
80 Quattro (78-86)	33
80 Quattro (87-91)	33
80 Quattro (92-95)	34
90 (85-87)	35
90 (87-91)	35
90 Quattro (84-87)	37
90 Quattro (87-91)	37
100 (68-76)	38
100 (76-79)	38
100 (80-81)	39
100 (82)	39
100 (83-90)	40
100 (91-94)	44
100 Quattro (85-90)	47
100 Quattro (91-94)	48
200 Quattro (85-91)	49
200 (80-83)	50
200 (84-91)	50
COUPE (81-88)	51
COUPE Quattro (85-87)	52
COUPE (89-96)	53
COUPE Quattro (87-96)	55
QUATTRO (80-91)	56
V8 (88-94)	57

AUSTIN

METRO (80-90)	57
MINI (67-93)	57

AUTO UNION

AU 1000 (58-65)	58
-----------------	----

AUTOBIANCHI

A 111 (69-72)	58
A 112 (69-86)	58
GIADINIERA (60-78)	58
Y 10 (85-95)	58

BMW

Isotta	59
1502 - 2002 (65-77)	59
2000 (66-69)	61
2,5/2,8/3,0/3,3 (68-77)	61
3er Reihe/E21 (75-83)	62
3er Reihe/E30 (82-93)	64
5er Reihe/E12 (72-81)	69
5er Reihe/E28 (81-87)	71
5er Reihe/E34 (88-96)	74
6er Reihe/E24 (76-89)	78
7er Reihe/E23 (77-86)	79
7er Reihe/E32 (86-94)	81
M1 (79-83)	82
Z1 (88-91)	83

BÜSSING

BUS BS 100 - BS 180	83
BUS KONSUL	83
BUS PRÄFEKT	83

**BÜSSING**

BUS PRÄSIDENT	84
BUS SENATOR	84
BUS TU 5 - TU 11	84
LKW BS 09 - BS 22	84
LKW COMMODORE	85
LKW LS7/LU7 - LS77/LU77	85
LKW SUPERCARGO	85
LKW 6000-8000	85

CHRYSLER

VOYAGER (ES) (90-95)	85
----------------------	----

CITROEN

2CV (63-90)	86
ACADIANE (78-85)	86
AMI 8 (69-78)	86
BX (82-93)	86
CX I Limousine (74-85)	88
CX I Kombi (75-85)	88
CX II Limousine (86-92)	89
CX II Kombi (86-92)	89
C15 (84-05)	89
C25 (81-94)	90
DYANE (69-83)	92
LN/LNA (76-86)	92
MEHARI (68-87)	93
VISA (78-89)	93
XM (Y3) Limousine (89-94)	93
XM (Y3) Kombi (91-94)	94

DAF

428-435 (89-93)	95
44 (66-74)	95
55 (67-72)	95
66 (72-75)	95

DAIHATSU

CHARADE (78-87)	96
CHARADE (87-92)	96
CUORE (80-85)	96
CUORE (85-90)	96
CUORE (90-94)	96
FEROZA (88-95)	96

DAIMLER

XJ (40,81) (89-94)	96
--------------------	----

DE TOMASO

PANTERA	96
---------	----

DKW

F102 (64-66)	96
Meisterklasse/Sonderklasse/Universal (50-57)	96
3=6 (55-57)	97

FAUN

Kraftkarren (Kraka)	97
---------------------	----

FERRARI

FERRARI	97
---------	----

FIAT

124 (66-74)	97
125 (66-74)	97
126 (72-90)	97
127 (71-86)	98
128 (69-84)	98
131 (74-84)	99
132 (72-81)	99
500/600 (-75)	99
850 (68-72)	99
900 (78-85)	99
ARGENTA (81-86)	100
CROMA (85-90)	100
CROMA (91-96)	101
DUCATO (81-94)	102
DUNA (87-90)	103
FIORINO (88-93)	103
PANDA (80-85)	104
REGATA (83-89)	104
RITMO (78-88)	105

**FIAT**

TALENTO (88-94)	106
TEMPRA (90-93)	106
TEMPRA (93-96)	108
TIPO (88-93)	109
TIPO (93-95)	111
UNO (83-89)	113
UNO (90-06)	114
X 1/9 (72-89)	115

FORD

A-Serie (73-83)	116
12M/15M (62-70)	116
17M/20M/26M (60-71)	116
CAPRI (68-74)	116
CAPRI (74-86)	116
CONSUL / GRANADA (72-85)	116
ECONOVAN (85-92)	118
ESCORT (70-80)	118
ESCORT / ORION (81-85)	118
ESCORT / ORION (86-90)	119
ESCORT / ORION (91-94)	120
FIESTA (76-89)	122
FIESTA III (89-96)	122
MAVERICK (93-96)	125
MONDEO I (93-96)	126
PROBE (91-92)	128
SCORPIO / GRANADA (GB) (85-91)	128
SCORPIO / GRANADA (GB) (92-94)	129
SIERRA (82-86)	129
SIERRA (87-93)	131
TAUNUS / CORTINA (GB) (70-82)	134
TRANSIT (65-77)	135
TRANSIT (78-85)	136
TRANSIT (86-91)	137
TRANSIT (92-94)	139

GLAS

GOGGOMOBIL (55-69)	142
--------------------	-----

HANOMAG

A-L 28	142
F 20 - F 86	142
GARANT	143
KURIER	143
MARKANT / ATHLET	143
MATADOR	143

HENSCHEL

F111 - F 261	143
HS 3 - HS 160	143

HONDA

ACCORD (81-85)	144
ACCORD (85-89)	144
ACCORD (90-93)	144
ACURA INTEGRA (84-90)	144
BALLADE (GB) (86-91)	144
CONCERTO (90-95)	145
CIVIC (79-83)	145
CIVIC (83-87)	145
CIVIC (3-tuerig) (87-91)	145
CIVIC (4-tuerig) (87-91)	146
CIVIC (3-tuerig) (91-95)	146
CIVIC (4-tuerig) (91-95)	146
CIVIC (5-tuerig) (94-96)	147
CIVIC COUPE (94-95)	147
CIVIC SHUTTLE (83-87)	147
CIVIC SHUTTLE (87-91)	148
CRX (83-87)	148
CRX (87-91)	148
LEGEND (86-88)	148
LEGEND (91-96)	148
PRELUDE (83-87)	149
PRELUDE (87-91)	149
PRELUDE (92-96)	149
QUINTET (80-83)	149

HYUNDAI

LANTRA/ELANTRA (90-95)	149
PONY/EXCEL (89-94)	149
PONY/EXCEL (94-95)	149
SONATA (88-93)	150
S-COUPE (90-96)	150
STELLAR (84-90)	150

INNOCENTI

INNOCENTI	150
-----------	-----



**ISUZU**

TROOPER (81-86)	150
TROOPER (86-91)	150

IVECO

EUROCARGO	151
LKW 75-330	151
Z-REIHE / ZETA	151

JAGUAR

XJ (XJ40,81) (86-96)	151
XJS (88-96)	152

JEEP

CHEROKEE(XJ)/WAGON(XJ)/COMANCHE(MJ) (87-04)	152
WRANGLER I (YJ) (87-96)	152

KÄSSBOHRER

S 6 - S 215	152
-------------	-----

KIA

PRIDE Limousine (90-94)	153
-------------------------	-----

LADA

1200-1600 (2101/2102/2103/2106) (73-86)	153
FORMA (2108) (89-95)	154
NIVA (2121) (76-95)	154
NIVA (2121) (93-)	154
NOVA (2104/2105) (75-96)	154
TOSCANA (2107) (83-96)	155

LANCIA

DEDRA (90-93)	155
DELTA (79-86)	156
DELTA (86-93)	156
PRISMA (83-86)	157
PRISMA (86-89)	157
THEMA (84-88)	158
THEMA (89-92)	158
THEMA (92-94)	159
Y 10 (85-95)	159

LAND ROVER

90/110 (83-90)	160
DEFENDER (LD) (90-)	160
RANGE ROVER I (70-94)	161

LLOYD

(55-61)	161
---------	-----

MAGIRUS

BUS SATURN	161
BUS 100	161
BUS 110	161
BUS 120	161
BUS 130	162
BUS 150	162
BUS 160-180	162
BUS 200	162
BUS 230	162
BUS 232/260	162
LKW JUPITER	163
LKW MERCUR	163
LKW SATURN/PLUTO	163
LKW SIRIUS	163
LKW 100	163
LKW 110	163
LKW 120	164
LKW 126	164
LKW 130	164
LKW 135	166
LKW 140/150	166
LKW 160/168	166
LKW 170	167
LKW 180/186	168
LKW 192-210	168
LKW 230	168
LKW 232	168
LKW 250/260	169
LKW 270	169
LKW 290	170
LKW 310	170

**MAGIRUS**

LKW 340	170
LKW 70/75	170
LKW 80	170
LKW 90	171

MAN

BUS 192-890	171
LKW 10.126-10.230	172
LKW 11.136-11.192	172
LKW 12.168-12.215	172
LKW 13.136-13.256	173
LKW 14.168-14.220	173
LKW 15.136-15.240	174
LKW 16.168-16.361	174
LKW 19.168-19.361	175
LKW 20.192-20.321	176
LKW 21.212	176
LKW 22.192-22.321	177
LKW 26.162-26.365	177
LKW 30.192-30.321	177
LKW 32.280-32.365	178
LKW 33.240-33.365	178
LKW 415-2180	178
LKW 6.115	179
LKW 7.126-7.136	179
LKW 8.156-8.168	180
LKW 9.126-9.216	180

MASERATI

MASERATI	181
----------	-----

MAZDA

121 (87-91)	181
121 (91-96)	181
323 Limousine (85-89)	181
323 Limousine/323 F (89-94)	182
323 Kombi (86-94)	182
626 (82-87)	182
626 Limousine/Coupe (87-91)	182
626 Kombi (88-92)	183
929 (87-91)	183
E1400/E1800/E2000/E2200 Bus (84-87)	183
E1800/E2000/E2200 Kasten (84-87)	183
E1800/E2000/E2200 Pritsche (84-87)	183

MERCEDES BENZ

Ansteuerung für Druckluftbremsventil	184
BUS (BM 300/301) O 303	184
BUS (BM 302) O 302	184
BUS (BM 307) O 307	185
BUS (BM 309/310) O 309	185
BUS (BM 319) O 319	185
BUS (BM 321) O 321	185
BUS (BM 322) O 322	185
BUS (BM 352) OF 1313/1317/1413/1417	186
BUS (BM 358) OF 1113 B	186
LKW (BM 314) 608/709	186
LKW (BM 316) 808/809	186
LKW (BM 318) 811-1113	187
LKW (BM 323) 710	187
LKW (BM 328) 911	188
LKW (BM 338) 1418	188
LKW (BM 352) 1213/1216/1313/1317/1319/1813	188
LKW (BM 353) 810/911 B	189
LKW (BM 354) 1418/1424	189
LKW (BM 355) 2219	189
LKW (BM 358) 1013/1113 B	189
LKW (BM 360) 1513/1517/1519/1817/1819/2219	190
LKW (BM 380) 1013/1017/1019	190
LKW (BM 381) 1213/1217/1219	190
LKW (BM 383) 1413/1417/1419/1424	191
LKW (BM 385) 1613/1617/1619/1624/2219/2224	191
LKW (BM 387) 1626/1632/1719	192
LKW (BM 389) 1919/1926/1932	192
LKW (BM 391) 2026/2032	192
LKW (BM 393) 2226/2232	193
LKW (BM 395) 2626/2632	193
LKW (BM 615) 1222	193
LKW (BM 616) 1414/1417/1419/1422/1425	193
LKW (BM 617) 1614/1617/1619/1622/1625	194
LKW (BM 619) 2025/2219/2222/2225	194
LKW (BM 620) 1628/1633/1636/1638	194
LKW (BM 621) 1922/1928/1933/1936/1938	194
LKW (BM 622) 2028/2033	195
LKW (BM 623) 2228/2233/2236/2238	195
LKW (BM 624) 2628/2633/2636/2638	195
LKW (BM 625) 3025/3028/3250/3328/3850	196
LKW 1413/1513	196
Transporter (BM 309) L405-L410/L508	196
Transporter (BM 310) L508 D/L608 D	197
Transporter (BM 313) L613 D/L614 D	198
Transporter L319/L405-L408	198
Transporter 311/312	198

**MERCEDES BENZ**

MB-TRAC (BM 440) 65/70/700/800/900	198
MB-TRAC (BM 441) 1000	199
MB-TRAC (BM 442/443) 1100/1300/1500	199
UNIMOG (BM 403) 54/66/72/800	199
UNIMOG (BM 404) 82/110/404 S	200
UNIMOG (BM 406) 65/70/80/84/900	200
UNIMOG (BM 407) 600/650/650 L	201
UNIMOG (BM 411) 411	201
UNIMOG (BM 413) 72/80/800 L	202
UNIMOG (BM 416) 80/90/100/110/1100/1100 L	202
UNIMOG (BM 417) 800-1150	203
UNIMOG (BM 421) 40/45/52/60/600/600 L	203
UNIMOG (BM 424) 1000/1200	204
UNIMOG (BM 425) 120/150/1300/1500	204
UNIMOG (BM 426) 426	204
UNIMOG (BM 427) 1000-1650	205
UNIMOG (BM 431) 431.2	205
UNIMOG (BM 435) 435/1300 L/1700/1700 L	205
UNIMOG (BM 436) 1300/1700	206
UNIMOG (BM 437.1) 1350-2450	206
(R107) 280 SL-560 SL (71-89)	207
(R113) 230 SL-280 SL (63-71)	209
(R129) SL-Klasse (89-93)	210
(R198) 300 SL (55-60)	211
(W100) 600 (64-81)	211
(W105) 219 (56-59)	211
(W108) 250 S-300 SEb (65-72)	211
(W109) 300 SEL (65-72)	212
(W110) 190 c-230 (61-68)	213
(W111) 220-280 (59-71)	214
(W112) 300 SE (65-67)	215
(W114) 230.6-280 CE (67-76)	215
(W115) 200-240 D 3,0 (67-76)	217
(W116) 280 S-450 SEL 6,9 (72-80)	219
(W120) 180 b.c.Db,Dc (59-62)	220
(W121) 190 b.Db (59-61)	220
(W121) 190 SL (55-60)	220
(W123) 200-300 TD Turbo (76-85)	221
(W124) E-Klasse (85-93)	225
E-Klasse (W124) Limousine (93-95)	231
E-Klasse (S124) Kombi (93-96)	233
(W126) 260 SE-560 SEC (80-91)	236
(W128) 220 SE (58-60)	238
(W180) 220 S/SE (56-59)	238
(W201) 190-190 E 2,6 (82-93)	239
G-Klasse (W460) (79-93)	241
G-Klasse (W461) (90-)	242
S-Klasse (W140) (91-93)	243
Transporter (BM 601) 207 D-210 D	245
Transporter (BM 602) 307 D-310 D	247
Transporter (BM 605) 206/207	249
Transporter (BM 606) 306 DG/307	249
Transporter (BM 607) 206 D	250
Transporter (BM 608) 306 D	250
Transporter (BM 611) 407 D-410 D	250
Transporter (BM 667) 507 D-510	251
Transporter (BM 668) 609 D	251
Transporter (BM 669) 709 D/711 D	252
Transporter (BM 670) 809 D-814 D	252
Transporter (BM 631) MB 100 D (87-96)	253

MITSUBISHI

COLT/LANCER (78-84)	253
COLT/LANCER Limousine (84-88)	253
COLT/LANCER Limousine (88-92)	254
COLT/LANCER Limousine (92-96)	255
ECLIPSE I (91-95)	255
GALANT (84-87)	255
GALANT (4-tuerig) (87-92)	256
GALANT (5-tuerig) (88-92)	256
GALANT (92-96)	256
L 200 (86-96)	257
L 300 (80-86)	257
L 300 (86-94)	257
LANCER Kombi (85-92)	258
LANCER Kombi (92-96)	258
PAJERO (83-91)	258
SAPPORO (87-90)	259
SIGMA (90-96)	259
SPACE WAGON/VAN (83-91)	259
TREDIA/CORDIA (82-86)	259

NISSAN

100 NX (B13) (90-94)	259
200 SX/SILVIA (S12) (83-88)	260
200 SX (S13) (88-94)	260
240 SX (S13) (USA) (88-93)	260
300 ZX (Z31) (84-89)	260
AXCESS (M11) (USA) (89-94)	260
BLUEBIRD (U11/WU11) (83-90)	260
BLUEBIRD (T12) (85-90)	260
BLUEBIRD (T72) (88-90)	260
CHERRY (N12) (82-86)	261
LAUREL (C32) (84-90)	261
MAXIMA (J30) (88-94)	261
MICRA/MARCH (K10) (82-92)	261
PATROL (160) (79-88)	261

**NISSAN**

PATROL (260) (89-95)	261
PICK-UP (720) (79-85)	262
PRAIRIE (M10) (82-88)	262
PRAIRIE (M11) (EUROPA) (88-94)	262
PRIMERA (P10E) Limousine (90-96)	262
PULSAR (USA) (83-86)	263
SENTRA (USA) (82-86)	263
STANZA (T12) (84-86)	263
SUNNY (B11) (82-88)	263
SUNNY (B12) Coupe (86-90)	263
SUNNY (B12) Kombi (86-90)	263
SUNNY (B310) (78-82)	263
SUNNY (N13) (86-90)	263
SUNNY (N14) Limousine (90-95)	263
VANETTE (C220) (87-95)	264
VANETTE Bus (GC22) (86-95)	264
VANETTE Kasten (GC22) (87-95)	264
VIOLET/140J/160J (A10) (77-81)	264

NISSAN (DATSUN)

BLUEBIRD (810) (77-79)	265
------------------------	-----

NSU

PRINZ 4 (61-71)	265
RO 80 (67-77)	265
TT/TTS (65-71)	265
1000/1200 (63-72)	265

OPEL

ADMIRAL (64-78)	265
ASCONA 16 (70-75)	265
ASCONA B / Vauxhall Cavalier (75-81)	266
ASCONA C / Vauxhall Cavalier (82-88)	267
CAMPO (91-96)	269
COMMODORE A / Vauxhall Viceroy (67-71)	270
COMMODORE B / Vauxhall Viceroy (72-78)	270
COMMODORE C / Vauxhall Viceroy (78-83)	270
CORSA A / Vauxhall Nova (83-92)	270
DIPLOMAT A (64-69)	272
DIPLOMAT B (69-78)	272
GT (68-73)	273
KADETT B (65-73)	273
KADETT C / Vauxhall Chevette (73-79)	273
KADETT D / Vauxhall Astra D (79-84)	274
KADETT E / Vau. Astra E/Belmont (84-93)	275
KAPITÁN (55-63)	279
KAPITÁN A (64-69)	279
MANTA A (70-75)	279
MANTA B / Vauxhall Cavalier Coupe (76-88)	280
OMEGA A / Vauxhall Carlton (87-93)	281
REKORD A (63-65)	282
REKORD B (65-67)	282
REKORD C (66-71)	283
REKORD D / Vauxhall Carlton (72-77)	283
REKORD E / Vauxhall Carlton (77-86)	284
SENATOR A/MONZA / Vaux. Royal (78-87)	285
SENATOR B / Vauxhall Royal (88-93)	285
VECTRA A / Vauxhall Cavalier (89-95)	286

PEUGEOT

J7 (65-80)	289
J5 (81-94)	290
J9 (80-92)	291
104 (72-87)	291
106 (91-96)	292
204 (65-77)	295
205 (83-90)	295
304 (69-80)	297
305 (77-90)	297
309 (85-93)	299
404 (62-75)	301
405 (87-92)	302
405 (93-95)	304
504 (68-89)	306
505 (79-93)	307
604 (75-86)	309

POL MOT

125 (67-74)	309
126 (72-90)	309

PORSCHE

356 (51-65)	310
911 (63-90)	310
911 (964) (88-93)	311
911 CABRIO (964) (89-94)	312
912 TARGA (65-70)	312
912 (65-69)	312
914/4 (69-76)	313

**PORSCHE**

914/6 (70-73)	313
924 (76-85)	313
924S (86-88)	314
928 (77-95)	315
944 (81-91)	316
968 COUPE (91-95)	316
968 CABRIO (91-95)	317

RENAULT

ALPINE A310 (77-84)	317
ESPACE I (J/S 11_) (84-90)	317
ESPACE II (J/S 63_) (91-96)	318
ESTAFETTE (R_) (69-80)	320
FUEGO (80-92)	320
R4 (62-90)	321
R5 SUPER (85-96)	323
R5 (72-84)	328
R6 (69-80)	330
R9 (82-89)	330
R11 (83-89)	332
R12 (70-80)	334
R14 (76-83)	335
R15 (72-79)	335
R16 (68-80)	335
R17 (72-80)	335
R18 Kasten (79-86)	336
R18 Limousine (78-86)	336
R18 Variable (79-86)	337
R19 (3/5-tuerig) (B53/C53/S53_) (88-95)	338
R19 CHAMADE (L53_) (89-95)	343
R19 Cabriolet (D53_) (91-96)	347
R20 (76-84)	348
R21 Limousine (B48/L48_) (86-93)	348
R21 NEVADA (K48_) (86-95)	354
R25 (84-92)	358
R30 (75-84)	361
TRAFIC I Bus (T5/T6/T7) (80-89)	361
TRAFIC I Kasten (T1/T2/T3/T4) (80-89)	362
TRAFIC I PROPULSION (PXX) (80-89)	363

ROVER

200-Serie (XH) (85-89)	364
200-Serie (XW) (90-95)	364
400-Serie (XW) (90-95)	365
2000/2300/2600/3500 (SD) (76-86)	365
MINI (91-95)	365

SAAB

90 (84-87)	366
99 (69-73)	366
99 (74-84)	366
900 (79-93)	366
9000 (85-93)	367

SEAT

124 (66-74)	368
127 (72-83)	368
128 (69-84)	368
131 (75-85)	368
132 (72-82)	368
600 (57-73)	368
850 (64-73)	368
FURA (82-86)	368
IBIZA I (85-92)	369
PANDA (80-86)	369
MALAGA (85-92)	369
RITMO (79-83)	370
RONDA (83-86)	370
TERRA (87-96)	371

SKODA

FAVORIT (781) (87-95)	371
FORMAN (785) (91-95)	371
PICK-UP (93-95)	371

STEYR DAIMLER PUCH

CITY-BUS (82-92)	372
HAFLINGER (61-79)	372
PINZGAUER (71-76)	372
TRA 292 / TRA 395 (60-68)	372
380-10230 (58-88)	372
500/600/700 (58-69)	373

SUBARU

1300/1600/1800 (84-90)	373
JUSTY (3-tuerig) (84-95)	373
JUSTY (5-tuerig) (84-95)	373

**SUBARU**

LEGACY (89-93)	374
LIBERO E10/E12 (87-93)	374

SUZUKI

SJ410 (81-88)	374
SJ413 (84-90)	374
ALTO (86-91)	374
CAPPUCINO (92-95)	374
SAMURAI (88-92)	374
SUPER-CARRY (80-85)	374
SUPER-CARRY (85-88)	375
SWIFT I (84-89)	375
SWIFT II (89-96)	375

TALBOT

1100 (68-81)	375
1301 (66-76)	376
1307 (75-80)	376
1308 (78-81)	376
1309 (78-80)	376
1501 (66-76)	376
1510/ALPINE (79-84)	376
HORIZON (78-86)	377
MATRA BAGHEERA (74-80)	377
MATRA MURENA (81-85)	377
MATRA RANCHO (77-84)	377
SAMBA (81-86)	377
SOLARA (80-86)	378
TAGORA (80-87)	378

TOYOTA

4-RUNNER (83-88)	378
4-RUNNER (88-96)	378
CAMRY (82-86)	379
CAMRY (86-91)	379
CAMRY (91-96)	379
CARINA II (83-87)	379
CARINA II (87-92)	379
CELICA (85-89)	380
CELICA (89-93)	380
COROLLA (83-87)	380
COROLLA (87-92)	380
CORONA (82-87)	380
CROWN (74-79)	381
CROWN (79-83)	381
CROWN (83-87)	381
HIACE (77-82)	381
HIACE (Pickup) (83-85)	381
HIACE (Bus) (83-87)	381
HIACE (87-89)	381
HIACE (89-95)	382
HILUX (78-83)	382
HILUX (83-88)	382
LAND CRUISER 40-47 (80-86)	382
LAND CRUISER 40-55 (69-80)	383
LAND CRUISER 70-75 (84-89)	383
LAND CRUISER 70-75 (90-96)	383
LAND CRUISER STATION WAGON 60-62 (80-89)	383
MODEL-F (82-88)	383
MODEL-F (88-90)	383
MR2 (84-89)	383
PASEO (91-95)	383
STARLET (84-89)	384
STARLET (89-96)	384
SUPRA (86-93)	384
TERCEL (82-88)	384

TRABANT

1,1 (90-91)	384
601 (65-90)	384

VOLKSWAGEN

411/412 (Typ 4) (68-75)	384
1500/1600 (TYP 3) (61-75)	384
CADDY I (83-92)	385
CORRADO (88-95)	385
DERBY/POLO Stufenheck (77-88)	387
GOLF I (74-83)	388
GOLF I Cabriolet (79-93)	390
GOLF II (84-93)	392
JETTA I (79-83)	396
JETTA II (84-92)	398
KÄFER (TYP 1) (49-03)	401
LT/LT 4x4 (75-96)	402
PASSAT Limousine (85-88)	404
PASSAT Variant (73-84)	405
PASSAT Variant (85-88)	407
PASSAT/SANTANA Limousine (73-84)	409
PASSAT (88-93)	411
PASSAT (94-96)	414
POLO I (75-81)	417





VOLKSWAGEN

POLO II (81-94)	418
SCIROCCO I (74-83)	419
SCIROCCO II (84-92)	420
TRANSPORTER (Typ 2) (60-79)	421
TRANSPORTER (Typ 2) (79-92)	423
TYP 181 (69-79)	425

VOLVO

























66 (75-80)	425
140 Limousine (68-75)	425
145 Kombi (68-75)	425
164 (68-74)	425
240 Limousine (74-93)	426
240 Kombi (74-93)	429
260 Limousine (74-82)	432
260 Kombi (75-82)	433
260 Coupe (77-78)	434
340 (76-90)	434
345 (80-89)	434
360 (82-90)	435
440 (88-96)	435
460 (88-96)	437
480 (86-96)	439
740 Limousine (83-92)	440
740 Kombi (85-92)	447
760 Limousine (82-92)	452
760 Kombi (82-92)	454
850 Limousine (91-96)	456
850 Kombi (92-96)	458
940 I Limousine (90-95)	460
940 I Kombi (90-95)	462
960 I Limousine (90-94)	465
960 I Kombi (90-94)	466
960 II Limousine (94-96)	467
960 II Kombi (94-96)	468
1800 Sport (68-72)	468

WARTBURG























1,3 (88-91)	468
353 (69-88)	468

ZASTAVA

101 (73-93)	468
750	468

										
ALFA ROMEO 6 (79-86)										
	2.5 i.e.			04.79	12.86		13.0441-4018.2	250083	Dichtungssatz	ATE
	2.5 i.e.			04.79	12.86		13.0460-9034.2	609034	20437 15,0 /WE	ATE
	2.5 i.e.			04.79	12.86		13.0441-4212.2	250089	Dichtungssatz	ATE
ALFA ROMEO 33 (83-89)										
	1.2			05.83	08.89		11.0101-4802.2	260007	Hülsensatz	ATE
	1.3			05.83	08.89					
	1.5 Lim.			05.83	08.89					
	1.5 Sportwagon			05.83	08.89					
	1.7	77		03.88	08.89					
	1.8 TD			10.86	08.89	+ ①				
	1.7	84		03.88	08.89		11.0441-4810.2	250023	Dichtungssatz	ATE
							11.0101-4802.2	260007	Hülsensatz	ATE
	1.2			09.85	08.89		13.0460-7055.2	607055	21063 14,8 +/WK	ATE
	1.3			09.85	08.89		13.0460-3905.2	603905	21132 14,7 +/WK	BDX
	1.5 Lim.			09.85	08.89					
	1.5 Sportwagon			09.85	08.89					
	1.7	77		03.88	08.89					
	1.8 TD			10.86	08.89	+ ①				
	1.7	84		03.88	08.89		13.0460-2969.2	602969	21165 16,8 +/WK	LUC
	1.2			09.85	08.89		24.0113-0171.1	413171	239 12,6 9,0	
	1.3			09.85	08.89					
	1.5 Lim.			09.85	08.89					
	1.5 Sportwagon			09.85	08.89					
	1.7	77		03.88	08.89					
	1.8 TD			10.86	08.89	+ ①				
	1.7	84		03.88	08.89		24.0122-0128.1	422128	239 22,0 20,2 V	
	1.2			09.85	08.89		24.3217-1112.3	020175	Rz 17,46	BDX
	1.3			09.85	08.89					
	1.5 Lim.			09.85	08.89					
	1.5 Sportwagon			09.85	08.89					
	1.7			03.88	08.89					
	1.8 TD			10.86	08.89	+ ①				
	1.2			05.83	08.85		03.0137-0139.2	650139	229 x 42	BDX
	1.3			05.83	08.85		03.0137-9020.2	669020	Bremsbacken-Zubehör	BDX
	1.5 4x4			05.83	08.89					
	1.5 Lim.			05.83	08.85					
	1.7 4x4			03.88	08.89					
	1.2			09.85	08.89		03.0137-0262.2	650262	203 x 39	BDX
	1.3			09.85	08.89		03.0137-9125.2	669125	Bremsbacken-Zubehör	BDX
	1.5 Lim.			09.85	08.89					
	1.5 Sportwagon			09.85	08.89					
	1.7			03.88	08.89					
	1.8 TD			10.86	08.89	+ ①				
	1.2			05.83	08.89		03.2419-8000.3	030017	- Bodenventil 1)	Gz 19,05
	1.3			05.83	08.89					
	1.5 Lim.			05.83	08.89					
	1.5 Sportwagon			05.83	08.89					
	1.7			03.88	08.89					
	1.8 TD			10.86	08.89	+ ①				
	1.2			05.83	08.89		03.2525-2201.3	040026		Nz 25,40
	1.3			05.83	08.89					
	1.5 Lim.			05.83	08.89					
	1.5 Sportwagon			05.83	08.89					
	1.7			03.88	08.89					
	1.8 TD			10.86	08.89	+ ①				
ALFA ROMEO 33 (90-94)										
	1.7			09.89	08.94		11.0441-4810.2	250023	Dichtungssatz	ATE
	1.7 4x4			09.89	08.94		11.0101-4802.2	260007	Hülsensatz	ATE
	1.8 TD			09.89	08.94	+ ①				
	1.4			06.91	08.94		13.0460-2968.2	602968	20332 17,0 +/WK/S	LUC
	1.4 4x4			07.90	08.94					
	1.5			01.90	08.94					
	1.4			06.91	08.94		24.0113-0171.1	413171	239 12,6 9,0	
	1.4 4x4			07.90	08.94					
	1.5			01.90	08.94					
	1.8 TD			09.89	08.94	+ ①				
	1.7			09.89	08.94		24.0122-0128.1	422128	239 22,0 20,2 V	
	1.7 4x4			09.89	08.94					
	1.7			09.89	08.94	+ ABS	24.0111-0149.1	411149	241 11,0 9,2	
	1.4			06.91	08.94		24.3217-1112.3	020175	Rz 17,46	BDX
	1.4 4x4			07.90	08.94					
	1.5			01.90	08.94					
	1.7			09.89	08.94	- ABS				
	1.7 4x4			09.89	08.94	- ABS				



























1) - residual press.center valve / - valvola p.pressione residua / - soup.de pression résiduelle / - válvula de fondo

































								
ALFA ROMEO 33 (90-94)								
	1.8 TD			09.89	08.94 + ①	24.3217-1112.3	020175	Rz 17,46 BDX
	1.4 1.4 4x4 1.5 1.7 1.7 4x4 1.8 TD			06.91 07.90 01.90 09.89 09.89 09.89	08.94 08.94 08.94 - ABS - ABS + ①	03.0137-0262.2 03.0137-9125.2	650262 669125	203 x 39 Bremsbacken-Zubehör BDX
	1.4 1.4 4x4 1.5 1.7 1.7 1.7 1.7 4x4 1.8 TD	77 79 97		06.91 07.90 01.90 09.89 09.89 09.89 09.89 09.89	08.94 08.94 08.94 - ABS - ABS - ABS - ABS + ①	24.3727-0003.2	580003	L=1712
	1.4 1.4 4x4 1.5 1.7 1.7 4x4 1.8 TD			06.91 07.90 01.90 09.89 09.89 09.89	08.94 08.94 08.94 - ABS - ABS + ①	03.2419-8000.3	030017	- Bodenventil ¹⁾ Gz 19,05
	1.4 1.4 4x4 1.5 1.7 1.7 4x4 1.8 TD			06.91 07.90 01.90 09.89 09.89 09.89	08.94 08.94 08.94 - ABS - ABS + ①	03.2525-2201.3	040026	Nz 25,40
ALFA ROMEO 75 (86-92)								
	1.6 1.8 1.8 Turbo 2.0 2.0 T.Spark 2.0 TD 2.4 TD 2.5 i V6 3.0 i V6			09.85 09.85 03.86 09.85 09.87 09.85 10.89 09.85 04.87	03.92 03.92 03.92 - gepanzerte Fahrzeuge ²⁾ 03.92 03.92 03.92 03.92 03.92	03.2122-0142.3	010128	Thz 22,20 ATE
	1.6 1.8 1.8 Turbo 2.0 2.0 T.Spark 2.0 TD 2.4 TD 2.5 i V6 3.0 i V6			09.85 09.85 03.86 09.85 09.87 09.85 10.89 09.85 04.87	03.92 03.92 03.92 03.92 03.92 03.92 03.92 03.92 03.92	03.3558-0676.3	310077	- ABS Behälter + WE
	1.6 1.8 2.0 2.0 T.Spark			09.85 09.85 09.85 09.87	03.92 03.92 03.92 + gepanzerte Fahrzeuge ³⁾	13.0441-4819.2	250104	Dichtungssatz ATE
	1.6 1.8 2.0 T.Spark	2050227 2050227		09.85 09.85 09.87	03.92 03.92 + gepanzerte Fahrzeuge ³⁾	13.0460-4019.2	604019	20911 15,0 +/WK ATE
	1.8 Turbo 2.0 T.Spark 2.5 i V6 3.0 i V6			03.86 09.87 09.85 04.87	03.92 03.92 - gepanzerte Fahrzeuge ²⁾ 03.92 03.92	24.0122-0119.2	422119	269 22,0 20,0 V
	1.6 1.8 1.8 Turbo 2.0 2.0 T.Spark 2.0 TD 2.4 TD 2.5 i V6 3.0 i V6			09.85 09.85 03.86 09.85 09.87 09.85 10.89 09.85 04.87	03.92 03.92 03.92 03.92 03.92 03.92 03.92 03.92 03.92	13.0441-3810.2	250066	Dichtungssatz ATE
	1.6 1.8 1.8 Turbo 2.0 2.0 T.Spark 2.0 TD 2.4 TD 2.5 i V6 3.0 i V6	2050227 2050227 2050227 2050227 2050227 2050227 2050227 2050227		09.85 09.85 03.86 09.85 09.87 09.85 10.89 09.85 04.87	03.92 03.92 03.92 08.87 03.92 03.92 03.92 03.92 03.92	13.0460-3013.2	603013	20912 15,0 +/WK ATE
	1.6 1.8 1.8 Turbo 2.0 T.Spark 2.0 TD 2.4 TD 2.5 i V6	2050228 2050228 2050228 2050228 2050228 2050228		03.92 03.92 03.92 03.92 03.92 03.92	03.92 03.92 03.92 03.92 03.92 03.92	13.0460-3014.2	603014	20387 15,0 +/WK ATE

¹⁾ - residual press.center valve / - valvola p.pressione residua / - soup.de pression résiduelle / - válvula de fondo





























²⁾ - armoured vehicles / - veicoli blindati / - véhicule blindé / - vehículo blindado

³⁾ + armoured vehicles / + veicoli blindati / + véhicule blindé / + vehículo blindado

								
ALFA ROMEO 75 (86-92)								
	3.0 i V6	2050228		03.92	13.0460-3014.2	603014		20387 15,0 +/WK ATE
	1.6			09.85 03.92	24.0110-0166.1	410166		250 9,9 8,0
	1.8			09.85 03.92				
	1.8 Turbo			09.90 03.92				
	2.0			09.85 08.87				
	2.0 T.Spark			09.87 03.92				
	2.0 TD			09.90 03.92				
	2.4 TD			09.90 03.92				
	2.5 i V6			09.90 03.92				
	3.0 i V6			09.90 03.92				
		1.8 Turbo						
2.0 TD				09.85 08.90				
2.4 TD				10.89 08.90				
2.5 i V6				09.85 08.90				
3.0 i V6				04.87 08.90				
	1.6			09.85 03.92	03.2419-8900.3	030024		Gz 19,05
	1.8			09.85 03.92				
	1.8 Turbo			03.86 03.92				
	2.0			09.85 08.87				
	2.0 T.Spark			09.87 03.92				
	2.0 TD			09.85 03.92				
	2.4 TD			10.89 03.92				
	2.5 i V6			09.85 03.92				
	3.0 i V6			04.87 03.92				
	ALFA ROMEO 90 (84-87)							
	1.8			09.84 08.87	03.2122-0142.3	010128		THz 22,20 ATE
	2.0			09.84 08.87				
	2.4 TD			09.84 08.87				
	2.5 i V6			09.84 08.87				
	1.8			09.84 08.87	03.3558-0676.3	310077		Behälter + WE
	2.0			09.84 08.87				
	2.4 TD			09.84 08.87				
	2.5 i V6			09.84 08.87				
	1.8			09.84 08.87	13.0441-4819.2	250104		Dichtungssatz ATE
	2.0			09.84 08.87				
	2.4 TD			09.84 08.87				
	2.5 i V6			09.84 08.87	24.0122-0119.2	422119		269 22,0 20,0 V
	1.8			09.84 08.87	13.0441-3810.2	250066		Dichtungssatz ATE
	2.0			09.84 08.87				
	2.4 TD			09.84 08.87				
	2.5 i V6			09.84 08.87				
	1.8			09.84 08.87	13.0460-3013.2	603013		20912 15,0 +/WK ATE
	2.0			09.84 08.87				
	2.4 TD			09.84 08.87				
	2.5 i V6			09.84 08.87				
	1.8			09.84 08.87	24.0110-0166.1	410166		250 9,9 8,0
	2.0			09.84 08.87				
	2.4 TD			09.84 08.87				
	2.5 i V6			09.84 08.87	24.0110-0179.1	410179		250 9,9 8,0
	1.8			09.84 08.87				
	2.0			09.84 08.87				
	2.4 TD			09.84 08.87				
	1.8			09.84 08.87	03.2419-8900.3	030024		Gz 19,05
	2.0			09.84 08.87				
	2.4 TD			09.84 08.87				
	2.5 i V6			09.84 08.87				
ALFA ROMEO 164 (87-91)								
	2.0 T.Spark	6.142.574		08.91	13.0460-2809.2	602809		21182 19,4 +/WK/S LUC
	2.0 Turbo			09.87 08.91				
	2.5 TD			09.87 08.91				
	3.0 i V6	135		09.87 08.91				
	3.0 i V6 Q.V.	147		07.90 08.91	13.0460-2980.2	602980		21147 19,0 +/WK/S LUC
	2.0 T.Spark		6.142.573	09.87				
	2.0 T.Spark	6.142.574		08.91				
	2.0 Turbo			09.87 08.91				
	2.5 TD			09.87 08.91				
	3.0 i V6	135		09.87 08.91	24.0122-0145.1	422145		284 22,0 20,2 V +B
	3.0 i V6 Q.V.	147		07.90 08.91				
	2.0 T.Spark	6.153.058		08.91				
	2.0 Turbo	6.153.058		08.91				
	2.5 TD	6.153.058		08.91	24.3384-1608.5	240168		D=38, - Halter LUC
	3.0 i V6	135 6.153.058		08.91				
	3.0 i V6 Q.V.	147 6.153.058		08.91				
	2.0 T.Spark			09.87 08.91				
	2.0 Turbo			09.87 08.91				
	2.5 TD			09.87 08.91	13.0460-2962.2	602962		20668 16,6 /S Belagsatz-Zubehör LUC
	3.0 i V6	135		09.87 08.91				
	3.0 i V6 Q.V.	147		07.90 08.91				
	2.0 T.Spark			09.87 08.91				
	2.0 Turbo			09.87 08.91				
				13.0460-0072.2	610072			

























								
ALFA ROMEO 164 (87-91)								
	2.0 T.Spark 2.0 Turbo 2.5 TD 3.0 i V6 3.0 i V6 Q.V.	135 147		09.87 09.87 09.87 09.87 07.90	08.91 08.91 08.91 08.91 08.91	24.0110-0190.1 24.0110-0209.1	410190 410209	252 10,0 9,0 +B 251 10,0 9,0 +B
	2.0 T.Spark 2.0 Turbo 2.5 TD 3.0 i V6 3.0 i V6 Q.V.	135 147		09.87 09.87 09.87 09.87 07.90	08.91 08.91 08.91 08.91 08.91	24.3727-0514.2	580514	1 ↓ L=2950
	2.0 T.Spark 2.0 Turbo 2.5 TD 3.0 i V6	135	6.219.010	09.87 09.87 09.87 09.87	08.91 08.91 08.91 08.91	24.2523-1702.3	040087	Nz 23,81
	3.0 i V6 3.0 i V6 Q.V.	135 147	6.219.011	09.87 07.90	08.91 08.91	03.2525-2201.3	040026	Nz 25,40
ALFA ROMEO 1300 GT Junior / 2000 GTV (66-79)								
	1300 GT Junior			01.72	12.78 + Bremsgerät 1)	03.2120-4504.3	010123	THz 20,64 ATE
	1300 GT Junior			01.72	12.78 + Bremsgerät 1)	03.3558-0676.3	310077	Behälter + WE
	1300 GT Junior 2000 GTV			01.66 01.71	12.78 12.79	13.0441-4819.2	250104	Dichtungssatz ATE
	1300 GT Junior			01.66	12.78	13.0460-4035.2 13.0460-0038.2	604035 610038	20173 15,0 Belagsatz-Zubehör ATE
	1300 GT Junior 2000 GTV			01.66 01.71	12.78 12.79	24.5307-0320.3	330703	2 L=320
	1300 GT Junior 2000 GTV			01.66 01.71	12.78 12.79	13.0441-3001.2 13.0441-3803.2	250041 250060	Dichtungssatz ATE Dichtungssatz ATE
	1300 GT Junior			01.66	12.78	13.0460-3010.2	603010	20009 15,0 ATE
	1300 GT Junior			01.66	12.78	24.0109-0101.1	409101	267 9,4 7,5
	1300 GT Junior			01.66	12.78	03.6048-0601.3	320052	BR 18/5 (2) ATE
	1300 GT Junior 2000 GTV			01.69 01.71	12.72 12.79	03.2417-0301.3	030004	Gz 17,46 ATE
	1300 GT Junior 2000 GTV			01.70 01.71	12.72 12.79	03.2525-1802.3 03.0450-2509.2	040025 082509	Nz 25,40 Nz Reparatursatz
ALFA ROMEO 1750 (68-72)								
	1750			01.70	12.72 + Bremsgerät 1)	03.2120-4504.3	010123	THz 20,64 ATE
	1750			01.70	12.72 + Bremsgerät 1)	03.3558-0676.3	310077	Behälter + WE
	1750			01.68	12.72	13.0441-4819.2	250104	Dichtungssatz ATE
	1750			01.68	12.72	13.0460-6027.2	606027	20011 15,0 ATE
	1750			01.68	12.72	24.5307-0320.3	330703	2 L=320
	1750			01.68	12.72	13.0441-3803.2	250060	Dichtungssatz ATE
	1750			01.68	12.72	24.0109-0101.1	409101	267 9,4 7,5
	1750			01.68	12.72	03.2417-0301.3	030004	Gz 17,46 ATE
	1750			01.70	12.72	03.2525-1802.3 03.0450-2509.2	040025 082509	Nz 25,40 Nz Reparatursatz

1) + booster unit / + servofreno / + servo-frein / + servofreno

								
ALFA ROMEO ALFASUD (71-84)								
	1.2 1.3 1.5 TI		01.74 01.74 01.74	09.84 09.84 09.84	+ Bremsgerät ¹⁾ + Bremsgerät ¹⁾ + Bremsgerät ¹⁾	03.2119-6207.3	010060	THz 19,05 ATE
	1.2 1.3 1.5 TI		04.71 04.71 04.71	09.84 09.84 09.84		13.0441-4212.2	250089	Dichtungssatz ATE
	1.2 1.3 1.5 TI		04.71 04.71 04.71	09.84 09.84 09.84		83.7704-0281.3	330804	2 L=280
	1.2 1.3 1.5 TI		04.71 04.71 04.71	09.84 09.84 09.84		13.0441-3302.2	250042	Dichtungssatz ATE
	1.2 1.3 1.5 TI		04.71 04.71 04.71	09.84 09.84 09.84		03.2419-8000.3	030017	- Bodenventil ²⁾ Gz 19,05
	1.2 1.3 1.5 TI		04.71 04.71 04.71	09.84 09.84 09.84		03.2525-2201.3	040026	Nz 25,40
ALFA ROMEO ALFETTA (72-84)								
	1.6 1.8 2.0 2.0 TD 2.4 TD		05.72 05.74 05.72 10.79 10.83	09.84 09.84 09.84 09.84 09.84		03.2122-0142.3	010128	THz 22,20 ATE
	1.6 1.8 2.0 2.0 TD 2.4 TD		05.72 05.74 05.72 10.79 10.83	09.84 09.84 09.84 09.84 09.84		03.3558-0676.3	310077	Behälter + WE
	1.6 1.8 2.0		05.72 05.74 05.72	09.84 09.84 09.84		13.0441-4819.2	250104	Dichtungssatz ATE
	2.0 TD 2.4 TD		10.79 10.83	09.84 09.84		13.0441-4819.2	250104	Dichtungssatz ATE
	1.6 1.8 2.0 2.0 TD		05.72 05.74 05.72 10.79	02.83 02.83 02.83 02.83		13.0460-4035.2 13.0460-0029.2	604035 610029	1979- 20173 15,0 Belagsatz-Zubehör ATE ATE
	1.6 1.8 2.0		03.83 03.83 03.83	09.84 09.84 09.84		13.0460-4019.2	604019	20911 15,0 +/WK ATE
	1.6 1.8 2.0 2.0 TD 2.4 TD		05.72 05.74 05.72 10.79 10.83	09.84 09.84 09.84 09.84 09.84		13.0441-3810.2	250066	Dichtungssatz ATE
	1.6 1.8 2.0 2.0 TD		05.72 05.74 05.72 10.79	02.83 02.83 02.83 02.83		13.0460-3011.2	603011	20641 15,0 + ATE
	1.6 1.8 2.0 2.0 TD 2.4 TD		03.83 03.83 03.83 03.83 10.83	09.84 09.84 09.84 09.84 09.84		13.0460-3013.2	603013	20912 15,0 +/WK ATE
	1.6 1.8 2.0 2.0 TD 2.4 TD		11.81 11.81 11.81 11.81 10.83	09.84 09.84 09.84 09.84 09.84		24.0110-0166.1	410166	250 9,9 8,0
	1.6 1.8 2.0		05.72 05.74 05.72	09.84 09.84 09.84		03.6048-0601.3	320052	BR 18/5 (2) ATE
	1.6 1.8 2.0 2.0 TD		09.82 09.82 09.82 09.82	08.83 08.83 08.83 08.83		03.2419-8601.3	030022	Gz 19,05 + Behälter
	1.6 1.8 2.0 2.0 TD 2.4 TD		09.83 09.83 09.83 09.83 10.83	09.84 09.84 09.84 09.84 09.84		03.2419-8900.3	030024	Gz 19,05
ALFA ROMEO AR 6 (85-89)								
	10 10 Bus 13 14 14 Turbo	51	04.85 04.85 04.85 03.86 09.86	12.89 12.89 12.89 12.89 12.89		24.2122-0801.3	010373	THz 22,20

¹⁾ + booster unit / + servofreno / + servo-frein / + servofreno

²⁾ - residual press.center valve / - valvola p.pressione residua / - soup.de pression résiduelle / - válvula de fondo

	 kW							
ALFA ROMEO AR 6 (85-89)								
	10 10 Bus 13 14 14 Turbo	51		04.85 12.89 04.85 12.89 04.85 12.89 03.86 12.89 09.86 12.89		13.0460-2901.2 602901		20741 19,0 +/WK/S LUC
	10 10 Bus 13 14 14 Turbo	51		04.85 12.89 04.85 12.89 04.85 12.89 03.86 12.89 09.86 12.89		24.0116-0105.1 416105		256 16,1 13,5 +B
	10 10 Bus 13 14 14 Turbo	51		04.85 12.89 04.85 12.89 04.85 12.89 03.86 12.89 09.86 12.89		24.3225-1101.3 020294		Rz 25,40 LUC
	10 10 Bus 13 14 14 Turbo	51		04.85 12.89 04.85 12.89 04.85 12.89 03.86 12.89 09.86 12.89		03.0137-0330.2 650330 03.0137-9216.2 669216		254 x 57 HEB LUC Bremsbacken-Zubehör LUC
	10 10 Bus 13 14 14 Turbo	51		04.85 12.89 04.85 12.89 04.85 12.89 03.86 12.89 09.86 12.89		24.0225-4002.1 480048		254/255,6 x 63,5
ALFA ROMEO AR 8 (78-89)								
	30 32 35 40			04.78 05.81 04.78 05.81 04.78 05.81 04.78 05.81		13.0460-0415.2 610415		Belagsatz-Zubehör AP
	30 32 35 35 Turbo 40 40 Turbo			06.81 05.86 06.81 05.86 06.81 05.86 04.85 05.86 06.81 05.86 04.85 05.86		13.0460-0415.2 610415		Belagsatz-Zubehör AP
	30 32 35 35 Turbo 40 40 Turbo			06.86 12.88 06.86 12.88 06.86 12.88 06.86 12.88 06.86 12.88		13.0460-0415.2 610415		Belagsatz-Zubehör AP
	30 32 35 35 Turbo 40 40 Turbo			01.89 12.89 01.89 12.89 01.89 12.89 01.89 12.89 01.89 12.89		13.0460-4955.2 604955 13.0460-0415.2 610415		21048 18,3 +/WK BRE Belagsatz-Zubehör AP
	30 32 35 35 Turbo 40 40 Turbo			04.78 12.89 04.78 12.89 04.78 12.89 04.85 12.89 04.78 12.89 04.85 12.89		03.0137-0309.2 650309 03.0137-0300.2 650300		254 x 70 254 x 89
ALFA ROMEO ARNA (83-87)								
	1.2 1.3 TI			09.83 12.86 09.83 12.86		11.0101-4802.2 260007		Hülsensatz ATE
	1.2 1.3 TI			09.85 12.86 09.85 12.86		13.0460-7055.2 607055		21063 14,8 +/WK ATE
	1.2 1.3 TI			09.85 12.86 09.85 12.86		24.0113-0171.1 413171		239 12,6 9,0
	1.2 1.3 TI			09.83 12.86 09.83 12.86		03.2419-8000.3 030017	- Bodenventil ¹⁾	Gz 19,05
	1.2 1.3 TI			09.83 12.86 09.83 12.86		03.2525-2201.3 040026		Nz 25,40
ALFA ROMEO GIULIA (62-78)								
	1300/1300 SUPER 1600 SUPER			01.68 12.78 01.68 12.78		13.0441-3001.2 250041		Dichtungssatz ATE
	1300/1300 SUPER 1600 SUPER			01.68 12.78 01.68 12.78		13.0460-3010.2 603010		20009 15,0 ATE
	1300/1300 SUPER 1600 SUPER			01.72 12.78 01.72 12.78		24.0109-0101.1 409101		267 9,4 7,5

¹⁾ - residual press.center valve / - valvola p.pressione residua / - soup.de pression résiduelle / - válvula de fondo

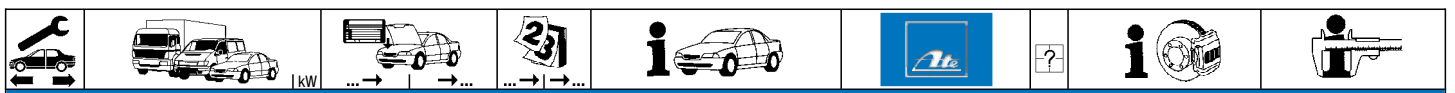





























ALFA ROMEO GIULIETTA (77-85)





























	1.3 1.6 1.8 1.8 Turbo 2.0 2.0 Turbo		10.77 10.77 04.79 01.84 06.80 07.83	06.83 04.85 04.85 12.85 04.85 06.84	03.2122-0142.3	010128		THz 22,20	ATE
	1.3 1.6 1.8 1.8 Turbo 2.0 2.0 Turbo		10.77 10.77 04.79 01.84 06.80 07.83	06.83 04.85 04.85 12.85 04.85 06.84	03.3558-0676.3	310077		Behälter + WE	
	1.3 1.6 1.8 1.8 Turbo 2.0 2.0 Turbo		10.77 10.77 04.79 01.84 06.80 07.83	06.83 04.85 04.85 12.85 04.85 06.84	13.0441-4819.2	250104		Dichtungssatz	ATE
	1.3 1.6 1.8 2.0		10.77 10.77 04.79 06.80	08.82 08.82 08.82 08.82	13.0460-4035.2 13.0460-0029.2	604035 610029		20173 15,0 Belagsatz-Zubehör	ATE ATE
	1.3 1.6 1.8 1.8 Turbo 2.0 2.0 Turbo		09.82 09.82 09.82 01.84 09.82 07.83	06.83 04.85 04.85 12.85 04.85 12.83	13.0460-4019.2	604019		20911 15,0 +/WK	ATE
	2.0 Turbo		07.83	06.84	24.0122-0119.2	422119		269 22,0 20,0 V	
	1.3 1.6 1.8 1.8 Turbo 2.0 2.0 Turbo		10.77 10.77 04.79 01.84 06.80 07.83	06.83 04.85 04.85 12.85 04.85 06.84	13.0441-3810.2	250066		Dichtungssatz	ATE
	1.3 1.6 1.8 2.0		10.77 10.77 04.79 06.80	04.83 04.83 04.83 04.83	13.0460-3011.2	603011		20641 15,0 +	ATE
	1.3 1.6 1.8 1.8 Turbo 2.0 2.0 Turbo		05.83 05.83 05.83 01.84 05.83 07.83	06.83 04.85 04.85 12.85 04.85 06.84	13.0460-3013.2	603013		20912 15,0 +/WK	ATE
	1.3 1.6 1.8 1.8 Turbo 2.0 2.0 Turbo		10.77 10.77 04.79 01.84 06.80 07.83	06.83 04.85 04.85 12.85 04.85 06.84	24.0110-0166.1	410166		250 9,9 8,0	
	1.3 1.6 1.8 2.0		10.77 10.77 04.79 06.80	06.83 08.83 08.83 08.83	03.2419-8601.3	030022		Gz 19,05 + Behälter	
	1.6 1.8 1.8 Turbo 2.0 2.0 Turbo		09.83 09.83 01.84 09.83 07.83	04.85 04.85 12.85 04.85 06.84	03.2419-8900.3	030024		Gz 19,05	

ALFA ROMEO GTV (81-87)

	2.0 2.5 i V6		11.80 11.80	01.86 02.87	03.2122-0142.3	010128		THz 22,20	ATE
	2.0 2.5 i V6		11.80 11.80	01.86 02.87	03.3558-0676.3	310077		Behälter + WE	
	2.0		11.80	01.86	13.0441-4819.2	250104		Dichtungssatz	ATE
	2.0		11.80	02.83	13.0460-4035.2 13.0460-0029.2	604035 610029		20173 15,0 Belagsatz-Zubehör	ATE ATE
	2.5 i V6		11.80	02.87	24.0122-0119.2	422119		269 22,0 20,0 V	
	2.0 2.5 i V6		11.80 11.80	01.86 02.87	13.0441-3810.2	250066		Dichtungssatz	ATE



								
ALFA ROMEO GTV (81-87)								
	2.0 2.5 i V6		11.80 11.80	01.86 02.86	13.0460-3011.2	603011		20641 15,0 + ATE
	2.5 i V6		03.86	02.87	13.0460-3013.2	603013		20912 15,0 +/-WK ATE
	2.0 2.5 i V6		11.80 11.80	01.86 02.87	24.0110-0166.1	410166		250 9,9 8,0
	2.5 i V6		11.80	02.87	24.0110-0179.1	410179		250 9,9 8,0
	2.0		11.80	10.84	03.6048-0601.3	320052		BR 18/5 (2) ATE
	2.0 2.5 i V6		11.80 11.80	08.83 08.83	03.2419-8601.3	030022		Gz 19,05 + Behälter
	2.0 2.5 i V6		09.83 09.83	01.86 02.87	03.2419-8900.3	030024		Gz 19,05
ALFA ROMEO MONTREAL (70-74)								
	2.6 i V8		01.70	09.73	03.2120-4504.3	010123		THz 20,64 ATE
	2.6 i V8		10.73	12.74	03.2122-0142.3	010128		THz 22,20 ATE
	2.6 i V8		01.70	12.74	03.3558-0676.3	310077		Behälter + WE
	2.6 i V8		01.70	12.74	24.5307-0320.3	330703	2	L=320
ALFA ROMEO R.Z. SPEEDSTER (92-93)								
	3.0 i V6		10.92	12.93	03.3558-0676.3	310077		Behälter + WE
	3.0 i V6		10.92	12.93	13.0460-3013.2	603013		20912 15,0 +/-WK ATE
	3.0 i V6		10.92	12.93	03.2419-8900.3	030024		Gz 19,05
ALFA ROMEO SPIDER (68-93)								
	1.3 Junior 1.6 1.6 Junior 2.0 2000 Veloce		01.68 12.83 01.68 09.79 01.77	12.77 08.93 11.83 12.93 05.86	03.2120-4504.3	010123		THz 20,64 ATE
	1.3 Junior 1.6 1.6 Junior 2.0 2000 Veloce		01.68 12.83 01.68 09.79 01.77	12.77 08.93 11.83 12.93 05.86	03.3558-0676.3	310077		Behälter + WE
	1.3 Junior 1.6 Junior		01.68 01.68	12.77 11.83	13.0441-4819.2	250104		Dichtungssatz ATE
	1.6 2.0 2000 Veloce		12.83 09.79 01.77	08.93 12.93 05.86	13.0441-4819.2	250104		Dichtungssatz ATE
	1.3 Junior 1.6 Junior		01.68 01.68	12.77 11.83	13.0460-4035.2	604035		20173 15,0 ATE
	1.6 2.0 2000 Veloce		12.83 09.79 01.77	08.93 12.93 05.86	13.0460-0038.2	610038		Belagsatz-Zubehör ATE
	1.6 2.0 2000 Veloce		12.83 09.79 01.77	08.93 12.93 05.86	13.0460-6027.2	606027		20011 15,0 ATE
	1.6 2.0 2000 Veloce		12.83 09.79 01.77	08.93 12.93 05.86	24.0113-0102.2	413102		272 12,7 10,7
	1.3 Junior 1.6 1.6 Junior 2.0 2000 Veloce		01.68 12.83 01.68 09.79 01.77	12.77 08.93 11.83 12.93 05.86	24.5307-0320.3	330703	2	L=320
	1.3 Junior 1.6 1.6 Junior 2.0 2000 Veloce		01.68 12.83 01.68 09.79 01.77	12.77 08.93 11.83 12.93 05.86	13.0441-3803.2	250060		Dichtungssatz ATE
	1.3 Junior 1.6 1.6 Junior 2.0 2000 Veloce		01.68 12.83 01.68 09.79 01.77	12.77 08.93 11.83 12.93 05.86	13.0460-3011.2	603011		20641 15,0 + ATE
	1.6 1.6 Junior 2.0 2000 Veloce		12.83 01.68 09.79 01.77	08.93 11.83 12.93 05.86	13.0460-0014.2	610014		Belagsatz-Zubehör ATE
	1.3 Junior 1.6 1.6 Junior 2.0 2000 Veloce		01.68 12.83 01.68 09.79 01.77	12.77 08.93 11.83 12.93 05.86	24.0109-0101.1	409101		267 9,4 7,5

								
ALFA ROMEO SPIDER (68-93)								
	1.3 Junior 1.6 1.6 Junior 2.0 2000 Veloce		01.68 12.83 01.68 09.79 01.77	12.77 08.93 11.83 12.93 05.86		03.0137-0149.2 650149		160 x 25
	1.3 Junior 1.6 1.6 Junior 2.0 2000 Veloce		01.68 12.83 01.68 09.79 01.77	12.77 06.90 11.83 06.90 05.86		03.6048-0601.3 320052		BR 18/5 (2) ATE
	1.3 Junior 1.6 1.6 Junior 2.0 2000 Veloce		01.68 12.83 01.68 09.79 01.77	12.77 08.93 11.83 12.93 05.86		03.2417-0301.3 030004		Gz 17,46 ATE
	1.3 Junior 1.6 1.6 Junior 2.0 2000 Veloce		01.68 12.83 01.68 09.79 01.77	12.77 08.93 11.83 12.93 05.86		03.2525-1802.3 040025 03.0450-2509.2 082509		Nz 25,40 Nz Reparatursatz
ALFA ROMEO SPRINT (76-89)								
	1.3 1.5		09.76 05.78	08.87 08.87		03.2119-6207.3 010060		THz 19,05 ATE
	1.3 1.5		09.76 05.78	11.83 11.83		13.0441-4212.2 250089		Dichtungssatz ATE
	1.3 1.5		12.83 12.83	12.89 12.87		11.0101-4802.2 260007		Hülensatz ATE
	1.7 i.e.		10.87	12.89		11.0441-4810.2 250023 11.0101-4802.2 260007		Dichtungssatz ATE Hülensatz ATE
	1.3 1.5 1.7 i.e.		09.85 09.85 10.87	12.89 12.87 12.89		13.0460-7055.2 607055 13.0460-3905.2 603905 13.0460-2969.2 602969		21063 14,8 +/WK ATE 21132 14,7 +/WK BDX 21165 16,8 +/WK LUC
	1.3 1.5 1.7 i.e.		09.87 09.87 10.87	12.89 12.87 12.89		24.0113-0171.1 413171 24.0122-0128.1 422128		239 12,6 9,0 239 22,0 20,2 V
	1.3 1.5		09.76 05.78	07.85 07.85		83.7704-0281.3 330804	2	L=280
	1.3 1.5		09.76 05.78	08.87 08.87		13.0441-3302.2 250042		Dichtungssatz ATE
	1.3 1.5 1.7 i.e.		09.76 05.78 10.87	12.89 12.87 12.89		03.2419-8000.3 030017		- Bodenventil ¹⁾ Gz 19,05
	1.3 1.5 1.7 i.e.		09.76 05.78 10.87	12.89 12.87 12.89		03.2525-2201.3 040026		Nz 25,40
ALFA ROMEO S.Z. COUPE (89-92)								
	3.0 i V6		03.89	12.91		03.3558-0676.3 310077		Behälter + WE
	3.0 i V6		03.89	12.91		13.0460-3013.2 603013		20912 15,0 +/WK ATE
	3.0 i V6		03.89	12.91		03.2419-8900.3 030024		Gz 19,05
AUDI 50 (74-78)								
	0.8 1.1 1.3	◀	01.76 08.74 08.77	07.78 07.78 07.78	- Bremsgerät ²⁾ - Bremsgerät ²⁾ - Bremsgerät ²⁾	03.2117-3311.3 010040		THz 17,46 ATE
	0.8 1.1 1.3	◀	01.76 08.74 08.77	07.78 07.78 07.78	+ Bremsgerät ³⁾ + Bremsgerät ³⁾ + Bremsgerät ³⁾	03.2120-1531.3 010092		THz 20,64 ATE
	0.8 1.1 1.3	◀	01.76 08.74 08.77	07.78 07.78 07.78		03.3508-7504.3 310045		ohne Warneinrichtung ⁴⁾ Behälter ATE
	0.8 1.1 1.3	◀	01.76 08.74 08.77	07.78 07.78 07.78		11.0441-4402.2 250014		Dichtungssatz ATE
	0.8 1.1 1.3	◀	01.76 08.74 08.77	07.78 07.78 07.78		13.0460-4028.2 604028		20228 15,3 ATE
	0.8 1.1 1.3	◀	01.76 08.74 08.77	07.78 07.78 07.78		24.0108-0100.1 408100		239 8,0 7,0

¹⁾ - residual press.center valve / - valvola p.pressione residua / - soup.de pression résiduelle / - válvula de fondo

²⁾ - booster unit / - servofreno / - servo-frein / - servofreno

³⁾ + booster unit / + servofreno / + servo-frein / + servofreno

⁴⁾ without alarm / senza dispositivo d'allarme/ sans dispositif d'avertissement / sin dispositivo avisador

Wrench and car icon		Truck and car icon		Car icon with '23' in a box		Car icon with 'i'		ATE logo		Car icon with 'i' and a question mark		Car icon with a key		
AUDI 50 (74-78)														
	0.8 1.1 1.3			01.76 08.74 08.77	07.78 07.78 07.78			83.7734-0290.3	330809	2			L=290	
	0.8 1.1 1.3			01.76 08.74 08.77	07.78 07.78 07.78			83.7824-0180.3	330812	2			L=180	
	0.8 1.1 1.3			01.76 08.74 08.77	07.78 07.78 07.78		- Bremskraftregler ¹⁾ - Bremskraftregler ¹⁾ - Bremskraftregler ¹⁾	03.3214-0812.3 24.3214-0902.3	020011 020147		+ GG ²⁾ + ALU ³⁾		Rz 14,29 Rz 14,29	
	0.8 1.1 1.3			01.76 08.74 08.77	07.78 07.78 07.78			03.0137-9006.2	669006				Bremsbacken-Zubehör	
	0.8 1.1 1.3			01.76 08.74 08.77	07.78 07.78 07.78			24.0218-0007.1 24.0218-0707.2	480003 480211				180/181 x 38,5 - Lager 180/181 x 38,5 + Lager	
	0.8 1.1 1.3			01.76 08.74 08.77	07.78 07.78 07.78			24.3727-0103.2	580103	1	↓		L=1960	
	0.8 1.1 1.3			01.76 08.74 08.77	07.78 07.78 07.78			24.3728-0101.2	590101				L=607	
AUDI 60/75/80/90 (65-73)														
	60 75 80 90			01.68 01.68 01.68 01.68	09.73 09.73 09.73 09.73		+ Schaltgetriebe ⁴⁾ + Schaltgetriebe ⁴⁾ + Schaltgetriebe ⁴⁾ + Schaltgetriebe ⁴⁾	13.0460-4033.2	604033				20034 15,0	ATE
	60 75 80			01.65 01.65 01.65	12.69 12.69 12.69			03.3215-0221.3	020013				Rz 15,87	
AUDI 80 (72-78)														
	1.3 1.5 1.6 Limousine 1.6 Limousine		55 63	01.72 05.72 09.75 09.75	08.78 08.75 08.78 08.78		+ Bremsgerät ⁵⁾ + Bremsgerät/ + Schaltgetriebe ⁶⁾ + Bremsgerät/ + Schaltgetriebe ⁶⁾ + Bremsgerät/ + Schaltgetriebe ⁶⁾	03.2120-1531.3	010092				Thz 20,64	ATE
	1.3 1.5 1.6 1.6 1.6 1.6		55 61 63 81	01.72 05.72 09.75 09.75 09.73	08.78 08.75 08.78 08.78 08.78			03.3508-7504.3	310045		ohne Warneinrichtung ⁸⁾		Behälter	ATE
	1.3 1.5 1.6 1.6		55 63	01.72 05.72 09.75 09.75	08.78 08.75 07.76 07.76			11.0441-4402.2	250014				Dichtungssatz	ATE
	1.5 1.6 1.6 1.6 1.6 1.6		55 55 61 63 63	05.72 09.75 08.76 09.73 09.75 08.76	08.75 07.76 08.78 08.78 07.76 08.78		+ Automatikgetriebe ⁷⁾ + Automatikgetriebe ⁷⁾ + Automatikgetriebe ⁷⁾ + Automatikgetriebe ⁷⁾ + Automatikgetriebe ⁷⁾ + Automatikgetriebe ⁷⁾	11.0441-4402.2	250014				Dichtungssatz	ATE
	1.6		81	09.73	08.78			11.0441-4402.2	250014				Dichtungssatz	ATE
	1.3 1.5 1.6 Limousine 1.6 Limousine		55 63	01.72 05.72 09.75 09.75	01.78 08.75 07.76 07.76			13.0460-4028.2 13.0460-0029.2	604028 610029				20228 15,3 Belagsatz-Zubehör	ATE ATE
	1.3			02.78	08.78			13.0460-4028.2 13.0460-0115.2	604028 610115				20228 15,3 Belagsatz-Zubehör	ATE ATE
	1.5 1.6 1.6 1.6 1.6 1.6 1.6 1.6 1.6 1.6 1.6		55 55 61 63 63 55 63 63	05.72 08.76 09.75 09.73 08.76 09.75 01.75 01.75	08.75 08.78 08.78 08.78 08.78 08.78 08.78 08.78		+ Automatikgetriebe ⁷⁾ + Schaltgetriebe ⁴⁾ + Automatikgetriebe ⁷⁾ + Schaltgetriebe ⁴⁾ + Automatikgetriebe ⁷⁾ + Schaltgetriebe ⁴⁾ + S ⁸⁾ ABS + S ⁸⁾ ABS	13.0460-4028.2	604028				20228 18,5	ATE
	1.6		81	09.73	08.78			13.0460-4028.2	604028				20228 15,3	ATE
	1.3 1.5 1.6 Limousine 1.6 Limousine		55 63	01.72 05.72 09.75 09.75	07.76 08.75 07.76 07.76			24.0110-0151.1 24.0310-0151.1	410151 510151				239 10,0 8,0 +S +B 239 10,0 8,0 +S +B PD	
	1.3 1.5 1.6 1.6 1.6 1.6 1.6 1.6 1.6 1.6		55 55 61 63 63 55 63 63	08.76 05.72 09.75 08.76 09.73 09.75 08.76 01.75 01.75	08.78 08.75 07.76 08.78 08.78 07.76 08.78 08.78 08.78			24.0112-0106.1 24.0312-0106.1	412106 512106				239 12,0 10,0 +S +B 239 12,0 10,0 +S +B PD	
	1.6 1.6 1.6 1.6 1.6 1.6 1.6		55 55 61 63 63 55 63	08.76 05.72 09.75 08.76 09.73 09.75 08.76 01.75 01.75	08.78 08.75 07.76 08.78 08.78 07.76 08.78 08.78 08.78			24.0120-0123.1 24.0320-0123.1	420123 520123				239 20,0 18,0 VL +S +B 239 20,0 18,0 VL +S +B PD	

¹⁾ - brake pressure regulator / - correttore di frenata / - correcteur de freinage / - corrector de frenado

²⁾ - cast iron / + ghisa / + fonte grise / + fundición de gris

³⁾ - aluminium / + alluminio / + aluminium / + aluminio

⁴⁾ - manual transmission / + scatola cambio velocità / + transmission mécanique / + cambio de velocidad

⁵⁾ - booster unit / + servofreno / + servo-frein / + servofreno

⁶⁾ - booster unit / + manual transm. / + servofreno/ + scatola camb.velocità / + servo-frein/ + transm.mécanique / + servofreno/ + camb.de velocidad

⁷⁾ - autom.transmission / + scatola cambio automatico / + transmission automatique / + cambio automático

⁸⁾ without alarm / senza dispositivo d'allarme / sans dispositif d'avertissement / sin dispositivo avisador

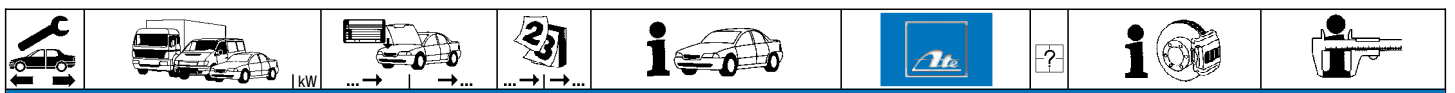

AUDI 80 (72-78)										
	1.3 1.5 1.6			01.72 05.72 09.73	08.78 08.75 08.78		24.5170-0315.3	331309	2	L=315
	1.3 1.5 1.6			01.72 05.72 09.73	08.78 08.75 08.78		83.7824-0180.3	330812	2	L=180
	1.3 1.5 1.6 Limousine	55 55		08.74 08.74 09.75	08.78 08.75 + Schaltgetriebe ³⁾ 08.78 + Schaltgetriebe ³⁾		03.3214-0812.3 24.3214-0902.3	020011 020147	+ GG ¹⁾ + ALU ²⁾	Rz 14,29 Rz 14,29
	1.5 1.5 1.6 1.6 1.6 1.6 1.6 Avant 1.6 Avant	55 63 55 61 84-52040210 63 81 84-52040210 55 63		08.74 08.74 09.75 08.78 09.75 01.75 01.75	08.75 + Automatikgetriebe ⁴⁾ 08.75 + Schaltgetriebe ³⁾ 08.78 + Automatikgetriebe ⁴⁾ 08.78 08.78 + Schaltgetriebe ³⁾ 08.78 08.78 + (S) ABS 08.78 + (S) ABS		03.3217-2112.3 24.3217-0908.3	020027 020167	+ GG ¹⁾ + ALU ²⁾	Rz 17,46 Rz 17,46
	1.3 1.5 1.6 Limousine 1.6 Limousine		55 63	09.74 09.74 09.75 09.75	08.78 08.75 + Schaltgetriebe ³⁾ 08.78 + Schaltgetriebe ³⁾ 08.78 + Schaltgetriebe ³⁾		03.0137-9006.2	669006	- autom. Nachstellung ⁵⁾	Bremsbacken-Zubehör
	1.3 1.5 1.6 Limousine 1.6 Limousine	55 55 63		01.72 05.72 09.75 09.75	08.78 08.75 + Schaltgetriebe ³⁾ 08.78 + Schaltgetriebe ³⁾ 08.78 + Schaltgetriebe ³⁾		24.0218-0007.1 24.0218-0707.2	480003 480211		180/181 x 38,5 - Lager 180/181 x 38,5 + Lager
	1.5 1.6 1.6 1.6 1.6 1.6 1.6 Avant 1.6 Avant	55 61 63 81 55 63		05.72 09.75 09.73 09.75 09.73 01.75 01.75	08.75 + Automatikgetriebe ⁴⁾ 08.78 + Automatikgetriebe ⁴⁾ 08.78 08.78 + Automatikgetriebe ⁴⁾ 08.78 08.78 + (S) ABS 08.78 + (S) ABS		24.0220-0018.1 24.0220-0718.2	480019 480209	ohne Sensorring ⁶⁾ ohne Sensorring ⁶⁾	200/201 x 50,5 - Lager 200/201,5 x 50,5 + Lager
	1.3 1.5 1.6			10.73 10.73 09.73	08.78 08.75 08.78		03.6565-0101.3	320097		BRL 6/5 (4) ATE
AUDI 80 (79-81)										
	1.3 1.6 1.6 1.6 1.6 D	51 55 63		09.78 09.78 09.78 08.80 08.80	07.81 07.81 + Schaltgetriebe ³⁾ 07.81 + Schaltgetriebe ³⁾ 07.81 + Schaltgetriebe ³⁾ 07.81 + Schaltgetriebe/ - (S) ⁷⁾		03.2120-1531.3	010092		Thz 20,64 ATE
	1.3 1.6		81-A0219025 81-A0219025	09.78 09.78			03.3508-7504.3	310045	ohne Warneinrichtung ¹⁰⁾	Behälter ATE
	1.3 1.6 1.6 1.6			09.78 09.78 09.78 09.78	07.81 07.81 07.81 07.81		11.0441-4402.2	250014 250014		Dichtungssatz ATE Dichtungssatz ATE
	1.3 1.6 1.6 1.6	51 55 63	81-92300000 81-92300000 81-92300000	09.78 09.78 09.78	07.81 07.81 07.81		13.0460-4028.2 13.0460-0115.2	604028 610115		20228 15,3 ATE Belagsatz-Zubehör ATE
	1.6 1.6 1.6	51 55 63	81-92300000 81-92300000 81-92300000	09.78 09.78 09.78	07.81 07.81 07.81		13.0460-4029.2	604029		20228 18,5 ATE
	1.3 1.6 1.6 D 1.7 2.2			09.78 09.78 08.80 08.80 10.80	07.81 07.81 07.81 07.81 07.81		24.0110-0151.1 24.0310-0151.1	410151 510151		239 10,0 8,0 +S +B 239 10,0 8,0 +S +B PD
	1.6 1.6 D 1.7 2.2			09.78 08.80 08.80 10.80	07.81 07.81 07.81 07.81		24.0112-0106.1 24.0312-0106.1	412106 512106		239 12,0 10,0 +S +B 239 12,0 10,0 +S +B PD
	1.3 1.6 1.6 D 1.7 2.2			09.78 09.78 08.80 08.80 10.80	07.81 07.81 07.81 07.81 07.81		24.5170-0315.3	331309	2	L=315
	1.3 1.6 1.6 D 1.7 2.2		81-A0190513 81-A0190513 81-A0190513 81-A0190513 81-A0190513	09.78 09.78 08.80 08.80 10.80			24.5201-0164.3	331414	2	L=164
	1.3 1.6 1.6 D 1.7 2.2	81-A0190514 81-A0190514 81-A0190514 81-A0190514 81-A0190514		07.81 07.81 07.81 07.81 07.81			83.6224-0200.3 24.5201-0164.3	330729 331414	 	L=200 L=164
	1.3 1.6 1.6 D 1.7 2.2			09.78 09.78 08.80 08.80 10.80	07.81 - Bremskraftregler ⁸⁾ 07.81 - Bremskraftregler ⁸⁾ 07.81 - Bremskraftregler ⁸⁾ 07.81 - Bremskraftregler ⁸⁾ 07.81 - Bremskraftregler ⁸⁾		03.3214-0812.3 24.3214-0902.3	020011 020147	+ GG ¹⁾ + ALU ²⁾	Rz 14,29 Rz 14,29
	1.3 1.6 1.6 D 1.7		81-A0046050 81-A0046050 81-A0046050 81-A0046050	09.78 09.78 08.80 08.80	+ Bremskraftregler ⁹⁾ + Bremskraftregler ⁹⁾ + Bremskraftregler ⁹⁾ + Bremskraftregler ⁹⁾		03.3217-2112.3 24.3217-0908.3	020027 020167	+ GG ¹⁾ + ALU ²⁾	Rz 17,46 Rz 17,46

1) + cast iron / + ghisa / + fonte grise / + fundición de gris

2) + aluminium / + alluminio / + aluminium / + aluminio

3) + manual transmission / + scatola cambio velocità / + transmission mécanique / + cambio de velocidad

4) + autom. transmission / + scatola cambio automatico / + transmission automatique / + cambio automático

5) - automatic adjustment / - correzione automatica / - ajustage automatique / - reajuste automatico

6) without sensor ring / senza sensori / sans secours ABS / sin anillo sensor ABS

7) + manual transmission / - (S) / + scatola camb. velocità / - (S) / + transmission mécanique / - (S) / + cambio

de velocidad / - (S)

8) - brake pressure regulator / - correttore di frenata / - correcteur de freinage / - corrector de frenado

9) + brake pressure regulator / + correttore di frenata / + correcteur de freinage / + corrector de frenado

10) without alarm / senza dispositivo d'allarme / sans dispositif d'avertissement / sin dispositivo avisador



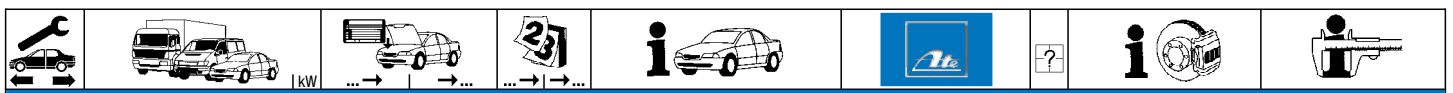

AUDI 80 (79-81)											
	2.2			81-A0046050	10.80		+ Bremskraftregler ¹⁾	03.3217-2112.3 24.3217-0908.3	020027 020167	+ GG ²⁾ + ALU ³⁾	Rz 17,46 Rz 17,46
	1.3			81-A0046051	07.81		+ Bremskraftregler ¹⁾	03.3215-2311.3	020018	+ GG ²⁾	Rz 15,87
	1.6			81-A0046051	07.81		+ Bremskraftregler ¹⁾	24.3215-0903.3	020154	+ ALU ³⁾	Rz 15,87
	1.6 D			81-A0046051	07.81		+ Bremskraftregler ¹⁾				
	1.7			81-A0046051	07.81		+ Bremskraftregler ¹⁾				
	2.2			81-A0046051	07.81		+ Bremskraftregler ¹⁾				
	1.3				09.78	07.81	- verstärkte Bremse ⁴⁾	03.0137-0126.2	650126		180 x 31 HEB
	1.6				09.78	07.81	- verstärkte Bremse ⁴⁾	03.0137-9008.2	669008		Bremsbacken-Zubehör
	1.6 D				08.80	07.81	- verstärkte Bremse ⁴⁾				
	1.7				08.80	07.81	- verstärkte Bremse ⁴⁾				
	2.2				10.80	07.81	- verstärkte Bremse ⁴⁾				
	1.3				09.78	07.81	+ verstärkte Bremse ⁵⁾	03.0137-0146.2	650146		200 x 40 HEB
	1.6				09.78	07.81	+ verstärkte Bremse ⁵⁾	03.0137-9041.2	669041		Bremsbacken-Zubehör
	1.6 D				08.80	07.81	+ verstärkte Bremse ⁵⁾				
	1.7				08.80	07.81	+ verstärkte Bremse ⁵⁾				
	2.2				10.80	07.81	+ verstärkte Bremse ⁵⁾				
	1.3				09.78	07.81	- verstärkte Bremse ⁴⁾	24.0218-0007.1	480003		180/181 x 38,5 - Lager
	1.6				09.78	07.81	- verstärkte Bremse ⁴⁾	24.0218-0707.2	480211		180/181 x 38,5 + Lager
	1.6 D				08.80	07.81	- verstärkte Bremse ⁴⁾				
	1.7				08.80	07.81	- verstärkte Bremse ⁴⁾				
	2.2				10.80	07.81	- verstärkte Bremse ⁴⁾				
	1.3				09.78	07.81	+ verstärkte Bremse ⁵⁾	24.0220-0018.1	480019	ohne Sensorring ⁶⁾	200/201 x 50,5 - Lager
	1.6				09.78	07.81	+ verstärkte Bremse ⁵⁾	24.0220-0718.2	480209	ohne Sensorring ⁶⁾	200/201,5 x 50,5 + Lager
	1.6 D				08.80	07.81	+ verstärkte Bremse ⁵⁾				
	1.7				08.80	07.81	+ verstärkte Bremse ⁵⁾				
	2.2				10.80	07.81	+ verstärkte Bremse ⁵⁾				
	1.3				09.78	07.81	- Regler/ - verstärkte Bremse ⁷⁾	03.0520-0114.3	690114		14,29/180x31 TopKit VW
	1.6				09.78	07.81	- Regler/ - verstärkte Bremse ⁷⁾				
	1.6 D				08.80	07.81	- Regler/ - verstärkte Bremse ⁷⁾				
	1.7				08.80	07.81	- Regler/ - verstärkte Bremse ⁷⁾				
	2.2				10.80	07.81	- Regler/ - verstärkte Bremse ⁷⁾				
	1.3			81-A0046050	09.78		+ Regler/ - verstärkte Bremse ⁸⁾	03.0420-0617.3	680617	+ Rz GG ⁹⁾	17,46/180x31 Kit VW
	1.6			81-A0046050	09.78		+ Regler/ - verstärkte Bremse ⁸⁾	03.0520-3917.3	693917	+ Rz ALU ¹⁰⁾	17,46/180x31 TopKit VW
	1.6 D			81-A0046050	08.80		+ Regler/ - verstärkte Bremse ⁸⁾				
	1.7			81-A0046050	08.80		+ Regler/ - verstärkte Bremse ⁸⁾				
	2.2			81-A0046050	10.80		+ Regler/ - verstärkte Bremse ⁸⁾				
	1.3			81-A0046051	07.81		+ Regler/ - verstärkte Bremse ⁸⁾	03.0520-0215.3	690215		15,87/180x31 TopKit VW
	1.6			81-A0046051	07.81		+ Regler/ - verstärkte Bremse ⁸⁾				
	1.6 D			81-A0046051	07.81		+ Regler/ - verstärkte Bremse ⁸⁾				
	1.7			81-A0046051	07.81		+ Regler/ - verstärkte Bremse ⁸⁾				
	2.2			81-A0046051	07.81		+ Regler/ - verstärkte Bremse ⁸⁾				
	1.3			81-A0046050	09.78		+ Regler/ + verstärkte Bremse ¹¹⁾	03.0420-0417.3	680417		17,46/200x40 Kit VW
	1.6			81-A0046050	09.78		+ Regler/ + verstärkte Bremse ¹¹⁾				
	1.6 D			81-A0046050	08.80		+ Regler/ + verstärkte Bremse ¹¹⁾				
	1.7			81-A0046050	08.80		+ Regler/ + verstärkte Bremse ¹¹⁾				
	2.2			81-A0046050	10.80		+ Regler/ + verstärkte Bremse ¹¹⁾				
	1.3				09.78	07.81		24.3727-0136.2	580136	<input type="checkbox"/>	L=1195
	1.6				09.78	07.81		24.3727-0139.2	580139	<input type="checkbox"/>	L=1150
	1.6 D				08.80	07.81					
	1.7				08.80	07.81					
	2.2				10.80	07.81					
	1.3				09.78	07.81		03.6565-0101.3	320097		BRL 6/5 (4) ATE
	1.6				09.78	07.81					
	1.6 D				08.80	07.81					
	1.7				08.80	07.81					
	2.2				10.80	07.81					

AUDI 80 (82-84)											
	1.3			81-C-250000	08.81			03.2120-1531.3	010092	Hub 16/14/+ Bremslichtschalt. ¹²⁾	THz 20,64 ATE
	1.6		55	81-C-250000	08.81						
	1.6		63	81-C-250000	08.81						
	1.6 D			81-C-250000	08.81						
	1.6		81	81-C-115000			07.84	+ verstärkte Bremse ⁵⁾	03.2122-9612.3	010159	THz 22,20 ATE
	1.8		82	81-C-115000			07.84	+ verstärkte Bremse ⁵⁾			
	2.0			81-C-115000			07.84	+ verstärkte Bremse ⁵⁾			
	2.2			81-C-115000			08.83	+ verstärkte Bremse ⁵⁾			
	1.3				08.81	07.84		24.0112-0106.1	412106		239 12,0 10,0 +S +B
	1.6				08.81	07.84		24.0312-0106.1	512106		239 12,0 10,0 +S +B PD
	1.6 D				08.81	07.84					
	1.6 TD				02.82	07.84					
	1.7				08.81	07.83					
	1.8				08.81	07.84					
	1.9				08.81	07.83					
	2.0				08.83	07.84					
	2.2				08.81	08.83					
	1.3				08.81	07.84		24.5170-0315.3	331309	2	L=315
	1.6				08.81	07.84					
	1.6 D				08.81	07.84					
	1.6 TD				02.82	07.84					
	1.7				08.81	07.83					
	1.8				08.81	07.84					
	1.9				08.81	07.83					
	2.0				08.83	07.84					
	2.2				08.81	08.83					

¹⁾ + brake pressure regulator / + correttore di frenata / + correcteur de freinage / + corrector de frenado
²⁾ + cast iron / + ghisa / + fonte grise / + fundición de gris
³⁾ + aluminium / + alluminio / + aluminio / + aluminio
⁴⁾ - heavy duty brake / - freno rinforzato / - frein renforcé / - freno reforzado
⁵⁾ + heavy duty brake / + freno rinforzato / + frein renforcé / + freno reforzado
⁶⁾ without sensor ring / senza sensori / sans secours ABS / sin anillo sensor ABS
⁷⁾ - regulator/ - heavy duty br. / - correttore fr./ - fr.rinforzato / - correcteur/ - frein renforcé / - regulador/ - freno reforzado
⁸⁾ + regulator/ - heavy duty brake / + correttore / - freno rinforzato / + correcteur/ - frein renforcé / + regulador/ - freno reforzado
⁹⁾ + WC cast iron / + CR ghisa / + CR fonte grise / + CR fundición de gris
¹⁰⁾ + WC aluminium / + CR alluminio / + CR aluminio / + CR aluminio
¹¹⁾ + regulator/ + heavy duty brake / + correttore / + freno rinforzato / + correcteur/ + frein renforcé / + regulador/ + freno reforzado
¹²⁾ stroke 16/14/+ stoplight swit. / corsa 16/14/+inter.luce arres. / course 16/14/+ contact.stop / elevac.16/14/+ inter. luz d.fr.

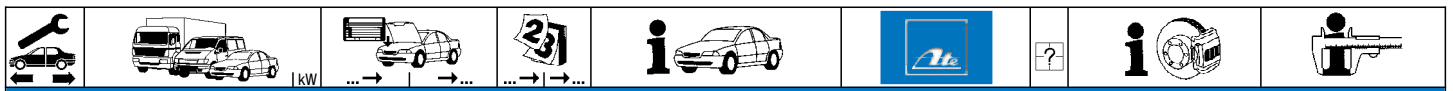

















AUDI 80 (82-84)

	1.3			08.81	07.84		83.6224-0200.3	330729	<input type="checkbox"/>	L=200 L=180
	1.6			08.81	07.84		83.7824-0180.3	330812		
	1.6 D			08.81	07.84					
	1.6 TD			02.82	07.84					
	1.7			08.81	07.83					
	1.8			08.81	07.84					
	1.9			08.81	07.83					
	2.0			08.83	07.84					
2.2			08.81	08.83						
	1.3			08.81	07.84	- verstärkte Bremse ¹⁾	03.3214-0812.3	020011	+ GG ²⁾ + ALU ³⁾	Rz 14,29 Rz 14,29
	1.6			08.81	07.84	- verstärkte Bremse ¹⁾	24.3214-0902.3	020147		
	1.6 D			08.81	07.84	- verstärkte Bremse ¹⁾				
	1.6 TD			02.82	07.84	- verstärkte Bremse ¹⁾				
	1.7			08.81	07.83	- verstärkte Bremse ¹⁾				
	1.8			08.81	07.84	- verstärkte Bremse ¹⁾				
	1.9			08.81	07.83	- verstärkte Bremse ¹⁾				
	2.0			08.83	07.84	- verstärkte Bremse ¹⁾				
2.2			08.81	08.83	- verstärkte Bremse ¹⁾					
	1.3			08.81	07.84	+ verstärkte Bremse ⁴⁾	03.3215-2311.3	020018	+ GG ²⁾ + ALU ³⁾	Rz 15,87 Rz 15,87
	1.6			08.81	07.84	+ verstärkte Bremse ⁴⁾	24.3215-0903.3	020154		
	1.6 D			08.81	07.84	+ verstärkte Bremse ⁴⁾				
	1.6 TD			02.82	07.84	+ verstärkte Bremse ⁴⁾				
	1.7			08.81	07.83	+ verstärkte Bremse ⁴⁾				
	1.8			08.81	07.84	+ verstärkte Bremse ⁴⁾				
	1.9			08.81	07.83	+ verstärkte Bremse ⁴⁾				
	2.0			08.83	07.84	+ verstärkte Bremse ⁴⁾				
2.2			08.81	08.83	+ verstärkte Bremse ⁴⁾					
	1.3			08.81	07.84	- verstärkte Bremse ¹⁾	03.0137-0126.2	650126		180 x 31 HEB Bremsbacken-Zubehör
	1.6			08.81	07.84	- verstärkte Bremse ¹⁾	03.0137-9008.2	669008		
	1.6 D			08.81	07.84	- verstärkte Bremse ¹⁾				
	1.6 TD			02.82	07.84	- verstärkte Bremse ¹⁾				
	1.7			08.81	07.83	- verstärkte Bremse ¹⁾				
	1.8			08.81	07.84	- verstärkte Bremse ¹⁾				
	1.9			08.81	07.83	- verstärkte Bremse ¹⁾				
	2.0			08.83	07.84	- verstärkte Bremse ¹⁾				
2.2			08.81	08.83	- verstärkte Bremse ¹⁾					
	1.3			08.81	07.84	+ verstärkte Bremse ⁴⁾	03.0137-0146.2	650146		200 x 40 HEB Bremsbacken-Zubehör
	1.6			08.81	07.84	+ verstärkte Bremse ⁴⁾	03.0137-9041.2	669041		
	1.6 D			08.81	07.84	+ verstärkte Bremse ⁴⁾				
	1.6 TD			02.82	07.84	+ verstärkte Bremse ⁴⁾				
	1.7			08.81	07.83	+ verstärkte Bremse ⁴⁾				
	1.8			08.81	07.84	+ verstärkte Bremse ⁴⁾				
	1.9			08.81	07.83	+ verstärkte Bremse ⁴⁾				
	2.0			08.83	07.84	+ verstärkte Bremse ⁴⁾				
2.2			08.81	08.83	+ verstärkte Bremse ⁴⁾					
	1.3			08.81	07.84	- verstärkte Bremse ¹⁾	24.0218-0007.1	480003		180/181 x 38,5 - Lager 180/181 x 38,5 + Lager
	1.6			08.81	07.84	- verstärkte Bremse ¹⁾	24.0218-0707.2	480211		
	1.6 D			08.81	07.84	- verstärkte Bremse ¹⁾				
	1.6 TD			02.82	07.84	- verstärkte Bremse ¹⁾				
	1.7			08.81	07.83	- verstärkte Bremse ¹⁾				
	1.8			08.81	07.84	- verstärkte Bremse ¹⁾				
	1.9			08.81	07.83	- verstärkte Bremse ¹⁾				
	2.0			08.83	07.84	- verstärkte Bremse ¹⁾				
2.2			08.81	08.83	- verstärkte Bremse ¹⁾					
	1.3			08.81	07.84	+ verstärkte Bremse ⁴⁾	24.0220-0018.1	480019	ohne Sensorring ⁵⁾ ohne Sensorring ⁵⁾	200/201 x 50,5 - Lager 200/201,5 x 50,5 + Lager
	1.6			08.81	07.84	+ verstärkte Bremse ⁴⁾	24.0220-0718.2	480209		
	1.6 D			08.81	07.84	+ verstärkte Bremse ⁴⁾				
	1.6 TD			02.82	07.84	+ verstärkte Bremse ⁴⁾				
	1.7			08.81	07.83	+ verstärkte Bremse ⁴⁾				
	1.8			08.81	07.84	+ verstärkte Bremse ⁴⁾				
	1.9			08.81	07.83	+ verstärkte Bremse ⁴⁾				
	2.0			08.83	07.84	+ verstärkte Bremse ⁴⁾				
2.2			08.81	08.83	+ verstärkte Bremse ⁴⁾					
	1.3			08.81	07.84	- verstärkte Bremse ¹⁾	03.0520-0114.3	690114		14,29/180x31 TopKit VW
	1.6			08.81	07.84	- verstärkte Bremse ¹⁾				
	1.6 D			08.81	07.84	- verstärkte Bremse ¹⁾				
	1.6 TD			02.82	07.84	- verstärkte Bremse ¹⁾				
	1.7			08.81	07.83	- verstärkte Bremse ¹⁾				
	1.8			08.81	07.84	- verstärkte Bremse ¹⁾				
	1.9			08.81	07.83	- verstärkte Bremse ¹⁾				
	2.0			08.83	07.84	- verstärkte Bremse ¹⁾				
2.2			08.81	08.83	- verstärkte Bremse ¹⁾					
	1.3			08.81	07.84	- verstärktes Fahrwerk ⁶⁾	24.3727-0136.2	580136	<input type="checkbox"/>	L=1195 L=1150
	1.6			08.81	07.84	+ verstärktes Fahrwerk ⁶⁾	24.3727-0139.2	580139		
	1.6 D			08.81	07.84	- verstärktes Fahrwerk ⁶⁾				
	1.6 TD			02.82	07.84	- verstärktes Fahrwerk ⁶⁾				
	1.7			08.81	07.83	- verstärktes Fahrwerk ⁶⁾				
	1.8			08.81	07.84	- verstärktes Fahrwerk ⁶⁾				
	1.9			08.81	07.83	- verstärktes Fahrwerk ⁶⁾				
	2.0			08.83	07.84	- verstärktes Fahrwerk ⁶⁾				
2.2			08.81	08.83	- verstärktes Fahrwerk ⁶⁾					
	1.3			08.81	07.84	+ verstärktes Fahrwerk ⁷⁾	24.3727-0136.2	580136	<input type="checkbox"/>	L=1195 L=1150
	1.6			08.81	07.84	+ verstärktes Fahrwerk ⁷⁾	24.3727-0139.2	580139		
	1.6 D			08.81	07.84	+ verstärktes Fahrwerk ⁷⁾				
	1.6 TD			02.82	07.84	+ verstärktes Fahrwerk ⁷⁾				
	1.7			08.81	07.83	+ verstärktes Fahrwerk ⁷⁾				
	1.7			08.81	07.83	+ verstärktes Fahrwerk ⁷⁾				

1) - heavy duty brake / - freno rinforzato / - frein renforcé / - freno reforzado
2) + cast iron / + ghisa / + fonte grise / + fundición de gris
3) + aluminium / + alluminio / + aluminium / + aluminio
4) + heavy duty brake / + freno rinforzato / + frein renforcé / + freno reforzado
5) without sensor ring / senza sensori / sans secours ABS / sin anillo sensor ABS
6) - reinforced suspension / - sospensione rinforzata / - châssis renforcé / - suspensión reforzada
7) + reinforced suspension / + sospensione rinforzata / + châssis renforcé / + suspensión reforzada



AUDI 80 (82-84)								
	1.8 1.9 2.0 2.2	08.81 08.81 08.83 08.81	07.84 07.83 07.84 08.83	+ verstärktes Fahrwerk ¹⁾ + verstärktes Fahrwerk ¹⁾ + verstärktes Fahrwerk ¹⁾ + verstärktes Fahrwerk ¹⁾	24.3727-0136.2 24.3727-0139.2	580136 580139	<input type="checkbox"/> <input type="checkbox"/>	L=1195 L=1150
	1.3 1.6 1.6 D 1.6 TD 1.7 1.8 1.9 2.0 2.2	08.81 08.81 08.81 02.82 08.81 08.81 08.81 08.83 08.81	07.84 07.84 07.84 07.84 07.83 07.84 07.83 07.84 08.83		03.6565-0101.3	320097		BRL 6/5 (4) ATE
AUDI 80 (84-87)								
	1.3 1.6 1.6 D 1.6 TD 1.8 2.0	06.84 06.84 06.84 06.84 06.84 02.86	03.87 03.87 03.87 03.87 03.87 03.87		03.7750-0302.4	300071		9" ATE
	1.3 1.6 1.6 D 1.6 TD 1.8 2.0	06.84 06.84 06.84 06.84 06.84 02.86	03.87 03.87 03.87 03.87 03.87 03.87		03.2120-2331.3	010110	Kompakt-THz ²⁾	THz 20,64 ATE
	1.8 2.0	06.84 02.86	03.87 03.87		13.0460-2936.2	602936		20574 15,3 /S LUC
	1.3 1.6 1.6 D 1.6 TD	06.84 06.84 06.84 06.84	03.87 03.87 03.87 03.87		24.0112-0106.1 24.0312-0106.1	412106 512106		239 12,0 10,0 +S +B 239 12,0 10,0 +S +B PD
	1.8 2.0	06.84 02.86	03.87 03.87		24.0120-0123.1 24.0320-0123.1	420123 520123		239 20,0 18,0 V L +S +B 239 20,0 18,0 V L +S +B PD
	1.3 1.6 1.6 D 1.6 TD 1.8 2.0	06.84 06.84 06.84 06.84 06.84 02.86	03.87 03.87 03.87 03.87 03.87 03.87		24.5170-0315.3	331309	2	L=315
	1.3 1.6 1.6 D 1.6 TD 1.8 2.0	06.84 06.84 06.84 06.84 06.84 02.86	03.87 03.87 03.87 03.87 03.87 03.87		83.6224-0200.3 83.7804-0150.3	330729 330853	<input type="checkbox"/> <input type="checkbox"/>	L=200 L=150
	1.3 1.6 1.6 D 1.6 TD 1.8 2.0	06.84 06.84 06.84 06.84 06.84 02.86	03.87 03.87 03.87 03.87 03.87 03.87		03.3214-0812.3 24.3214-0902.3	020011 020147	+ GG ³⁾ + ALU ⁴⁾	Rz 14,29 Rz 14,29
	1.3 1.6 1.6 D 1.6 TD 1.8 2.0	06.84 06.84 06.84 06.84 06.84 02.86	03.87 03.87 03.87 03.87 03.87 03.87		03.3215-2311.3 24.3215-0903.3	020018 020154	+ GG ³⁾ + ALU ⁴⁾	Rz 15,87 Rz 15,87
	1.3 1.6 1.6 D 1.6 TD 1.8 2.0	06.84 06.84 06.84 06.84 06.84 02.86	03.87 03.87 03.87 03.87 03.87 03.87		03.0137-0126.2 03.0137-9008.2	650126 669008		180 x 31 HEB Bremsbacken-Zubehör
	1.3 1.6 1.6 D 1.6 TD 1.8 2.0	06.84 06.84 06.84 06.84 06.84 02.86	03.87 03.87 03.87 03.87 03.87 03.87		03.0137-0146.2 03.0137-9041.2	650146 669041		200 x 40 HEB Bremsbacken-Zubehör
	1.3 1.6 1.6 D 1.6 TD 1.8 2.0	06.84 06.84 06.84 06.84 06.84 02.86	03.87 03.87 03.87 03.87 03.87 03.87		24.0218-0007.1 24.0218-0707.2	480003 480211		180/181 x 38,5 - Lager 180/181 x 38,5 + Lager
	1.3 1.6 1.6 D 1.6 TD 1.8 2.0	06.84 06.84 06.84 06.84 06.84 02.86	03.87 03.87 03.87 03.87 03.87 03.87		24.0220-0018.1 24.0220-0718.2	480019 480209	ohne Sensorring ⁵⁾ ohne Sensorring ⁵⁾	200/201 x 50,5 - Lager 200/201,5 x 50,5 + Lager
	1.3 1.6 1.6 D 1.6 TD 1.8 2.0	06.84 06.84 06.84 06.84 06.84 02.86	03.87 03.87 03.87 03.87 03.87 03.87		24.0220-0016.1	480018		200/201 x 52
	1.3	06.84	03.87		03.0520-0114.3	690114		14,29/180x31 TopKit VW
	1.3 1.6 1.6 D 1.6 TD 1.8 2.0	06.84 06.84 06.84 06.84 06.84 02.86	03.87 03.87 03.87 03.87 03.87 03.87		24.3727-0136.2 24.3727-0139.2	580136 580139	<input type="checkbox"/> <input type="checkbox"/>	L=1195 L=1150
	1.3 1.6 1.6 D 1.6 TD 1.8 2.0	06.84 06.84 06.84 06.84 06.84 02.86	03.87 03.87 03.87 03.87 03.87 03.87	- verstärkte Bremse ⁶⁾ - verstärkte Bremse ⁶⁾ - verstärkte Bremse ⁶⁾ - verstärkte Bremse ⁶⁾ - verstärkte Bremse ⁶⁾ - verstärkte Bremse ⁶⁾	03.6565-0101.3	320097		BRL 6/5 (4) ATE

¹⁾ + reinforced suspension / + sospensione rinforzata / + châssis renforcé / + suspensión reforzada



























²⁾ compact TMC / PFT compatta / MCT compact / CMT compacto

³⁾ + cast iron / + ghisa / + fonte grise / + fundición de gris

⁴⁾ + aluminium / + alluminio / + aluminium / + aluminio

⁵⁾ without sensor ring / senza sensori / sans secours ABS / sin anillo sensor ABS

⁶⁾ - heavy duty brake / - freno rinforzato / - frein renforcé / - freno reforzado

												
AUDI 80 (84-87)												
	1.3 1.6 1.6 D 1.6 TD 1.8 2.0			06.84 06.84 06.84 06.84 06.84 02.86	03.87 03.87 03.87 03.87 03.87 03.87	+ verstärkte Bremse ¹⁾ + verstärkte Bremse ¹⁾ + verstärkte Bremse ¹⁾ + verstärkte Bremse ¹⁾ + verstärkte Bremse ¹⁾ + verstärkte Bremse ¹⁾	03.6585-0108.3	320115		BRL 8/5 (4)	ATE	
	2.0			02.86	03.87		03.2419-8150.3	030019		Gz 19,05		
	2.0			02.86	03.87		03.2522-4211.3	040017		Nz 22,20		
AUDI 80 (87-91)												
	1.6 1.6 D 1.6 TD 1.8 1.9 D 1.9 E 2.0			09.86 02.87 04.88 09.86 08.89 09.86 08.88	07.91 07.89 07.91 07.91 07.91 07.88 07.91		03.7750-0302.4	300071		9"	ATE	
	1.6 1.6 D 1.6 TD 1.8 1.9 D 1.9 E 2.0			09.86 02.87 04.88 09.86 08.89 09.86 08.88	07.91 07.89 07.91 07.91 07.91 07.88 07.91		03.2122-9612.3 24.2122-1601.3	010159 010380	- ABS + ABS	THz 22,20 THz 22,20	ATE LUC	
	1.6 1.6 1.6 D 1.6 TD 1.6 TD 1.8 1.8 1.9 D			09.86 08.89 02.87 04.88 08.89 09.86 09.86 08.89	07.89 07.91 07.89 07.89 07.89 07.91 07.91 07.91	+ Schaltgetriebe ²⁾ + Schaltgetriebe ²⁾ - Taxi - Taxi/ + Schaltgetriebe ³⁾ + Schaltgetriebe ²⁾ + Schaltgetriebe ²⁾	24.3541-1610.5 24.3541-1609.5 11.0441-5405.2 11.0101-5409.2 24.0101-4301.2 11.0101-5403.2	240040 240039 250030 260035 260047 260010	 	D=54, - Halter D=54, - Halter Dichtungssatz Hülssensatz Bremsattel-Zubehör Faltenbalgsatz	LUC LUC ATE ATE LUC LUC	
	1.6 1.6 TD 1.6 TD 1.8 1.8 1.9 E 2.0			08.89 04.88 08.89 09.86 09.86 09.86 08.88	07.91 07.91 07.91 07.91 07.91 07.88 07.91	+ Automatikgetriebe ⁴⁾ + Taxi + Automatikgetriebe ⁴⁾ + Automatikgetriebe ⁴⁾ + Automatikgetriebe ⁴⁾	11.3541-8521.2 24.3541-1720.5 24.3541-1719.5 11.0441-5405.2 11.0101-5409.2 24.0101-4301.2 11.0101-5403.2	220113 240058 240057 250030 260035 260047 260010	  	D=54, - Halter D=54, - Halter D=54, - Halter Dichtungssatz Hülssensatz Bremsattel-Zubehör Faltenbalgsatz	ATE LUC LUC ATE ATE LUC LUC	
	1.6 1.6 D 1.6 TD 1.8 1.9 D 1.9 E 2.0			09.86 02.87 04.88 09.86 08.89 09.86 08.88	07.91 07.89 07.91 07.91 07.91 07.88 07.91		13.0460-2934.2	602934		20669 19,0 /S	LUC	
	1.6 1.6 1.6 D 1.6 TD 1.6 TD 1.8 1.8 1.9 D			09.86 08.89 02.87 04.88 08.89 09.86 09.86 08.89	07.89 07.91 07.89 07.89 07.89 07.91 07.91 07.91	+ Schaltgetriebe ²⁾ + Schaltgetriebe ²⁾ - Taxi - Taxi/ + Schaltgetriebe ³⁾ + Schaltgetriebe ²⁾ + Schaltgetriebe ²⁾	24.0113-0160.1	413160		256 13,0 11,0 +B		
	1.6 1.6 TD 1.6 TD 1.8 1.8 1.9 E 2.0			08.89 04.88 08.89 09.86 09.86 09.86 08.88	07.91 07.91 07.91 07.91 07.91 07.88 07.91	+ Automatikgetriebe ⁴⁾ + Taxi + Automatikgetriebe ⁴⁾ + Automatikgetriebe ⁴⁾ + Automatikgetriebe ⁴⁾	24.0122-0118.1	422118		256 22,0 20,0 V +B		
	1.6 1.6 D 1.6 TD 1.8 1.9 D 1.9 E 2.0		8A-L-038656 8A-L-038656 8A-L-038656 8A-L-038656 8A-L-038656	09.86 02.87 04.88 09.86 08.89 09.86 08.88	07.89 07.89 07.89 07.89 07.89 07.88 07.89		24.5170-0315.3	331309	2	L=315		
	1.6 1.6 TD 1.8 1.9 D 2.0	8A-L-038657 8A-L-038657 8A-L-038657 8A-L-038657 8A-L-038657			07.91 07.91 07.91 07.91 07.91		24.5237-0288.3 24.5170-0161.3	331442 331308	2 2	am Bremsattel ⁵⁾	L=288 L=161	
	1.6 1.6 D 1.6 TD 1.8 1.8 1.8		89-J-225956 89-J-225956 89-J-225956 89-J-225956 89-J-225956 89-J-225956	09.86 02.87 04.88 09.86 09.86 09.86		+ ABS + ABS + ABS + ABS + ABS	24.0101-3601.2	260044		Bremsattel-Zubehör	LUC	

1) + heavy duty brake / + freno reforzado / + frein renforcé / + freno reforzado
2) + manual transmission / + scatola cambio velocità / + transmission mécanique / + cambio de velocidad
3) - Taxi/ + manual transm. / - Taxi/ + scatola cambio velocità / - Taxi/ + transmission mécanique / - Taxi/ + cambio de velocidad
4) + autom.transmission / + scatola cambio automatico / + transmission automatique / + cambio automático
5) on the brake caliper / sulla pinza freno / sur l'étrier de frein / a la pinza de freno

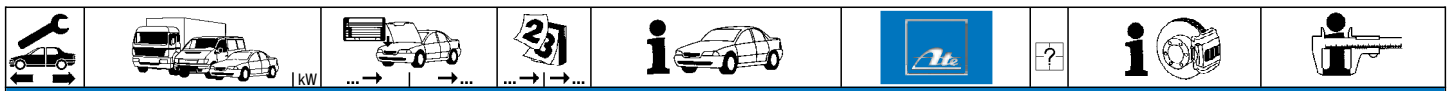

AUDI 80 (87-91)												
	1.9 E		89-J-221810	89-J-225956	09.86			24.0101-3601.2	260044		Bremssattel-Zubehör	LUC
	1.6		89-J-221810		07.91	+ ABS		24.3384-1601.5	240013		D=38, - Halter	LUC
	1.6 D		89-J-221810		07.89	+ ABS		24.3384-1602.5	240014		D=38, - Halter	LUC
	1.6 TD		89-J-221810		07.91	+ ABS		24.0101-3601.2	260044		Bremssattel-Zubehör	LUC
	1.8	55	89-J-221810		07.91	+ ABS						
	1.8	66	89-J-221810		07.91	+ ABS						
	1.8	82	89-J-221810		07.91	+ ABS						
	1.9 D				08.89	+ ABS						
	1.9 E		89-J-221810		07.88							
	2.0				08.88	07.91						
	1.6				09.86	07.91	+ ABS	13.0460-3602.2	603602		21144 15,8 /S	LUC
	1.6 D				02.87	07.89	+ ABS					
	1.6 TD				04.88	07.91	+ ABS					
	1.8	55			09.86	07.91	+ ABS					
	1.8	66			09.86	07.91	+ ABS					
	1.8	82			09.86	07.91	+ ABS					
	1.9 D				08.89	07.91	+ ABS					
	1.9 E				09.86	07.88						
	2.0				08.88	07.91						
	1.6				09.86	07.91	+ ABS	24.0110-0178.1	410178		245 10,0 8,0 +B	
	1.6 D				02.87	07.89	+ ABS					
	1.6 TD				04.88	07.91	+ ABS					
	1.8	55			09.86	07.91	+ ABS					
	1.8	66			09.86	07.91	+ ABS					
	1.8	82			09.86	07.91	+ ABS					
	1.9 D				08.89	07.91	+ ABS					
	1.9 E				09.86	07.88						
	2.0				08.88	07.91						
	1.6				09.86	07.91		83.6224-0200.3	330729		L=200	
	1.6 D				02.87	07.89		83.7804-0150.3	330853		L=150	
	1.6 TD				04.88	07.91		24.5170-0161.3	331308	2	L=161	
	1.8				09.86	07.91						
	1.9 D				08.89	07.91						
	1.9 E				09.86	07.88						
	2.0				08.88	07.91						
	1.6	51			09.86	07.91	- ABS/ - Bremskraftregler ²⁾	03.3215-2311.3	020018		+ GG ³⁾	Rz 15,87
	1.6	55			09.86	07.91	- ABS	24.3215-0903.3	020154		+ ALU ⁴⁾	Rz 15,87
	1.6 D				02.87	07.89	- ABS					
	1.8	55			09.86	07.91	- ABS/ + Schaltgetriebe ⁵⁾					
	1.6	51			09.86	07.91	- ABS/ + Bremskraftregler ⁶⁾	24.3219-0909.3	020188			Rz 19,05
	1.6 TD				04.88	07.91	- ABS					
	1.8	55			09.86	07.91	- ABS/ + Automatikgetriebe ⁷⁾					
	1.8	66			09.86	07.91	- ABS					
	1.8 S	65			09.86	07.91	- ABS					
	1.9 D				08.89	07.91	- ABS					
	1.6			89-K-200000	09.86		- ABS	03.0137-0146.2	650146			200 x 40 HEB
	1.6 D			89-K-200000	02.87		- ABS	03.0137-9041.2	669041			Bremsbacken-Zubehör
	1.6 TD			89-K-200000	04.88		- ABS					
	1.8	55		89-K-200000	09.86		- ABS					
	1.8	66		89-K-200000	09.86		- ABS					
	1.6		89-K-200001	8A-M-080000			- ABS	03.0137-0268.2	650268			200 x 40 HEB
	1.6 D		89-K-200001	8A-M-080000	07.89		- ABS	03.0137-9168.2	669168			Bremsbacken-Zubehör
	1.6 TD		89-K-200001	8A-M-080000			- ABS					
	1.8	55	89-K-200001	8A-M-080000			- ABS					
	1.8	66	89-K-200001	8A-M-080000			- ABS					
	1.9 D		89-K-200001	8A-M-080000	08.89		- ABS					
	1.6		8A-M-080001				- ABS	03.0137-0146.2	650146			200 x 40 HEB
	1.6 TD		8A-M-080001				- ABS	03.0137-9041.2	669041			Bremsbacken-Zubehör
	1.8	55	8A-M-080001				- ABS					
	1.8	66	8A-M-080001				- ABS					
	1.9 D		8A-M-080001				- ABS					
	1.6			89-K-120000	09.86		- ABS	24.0220-0016.1	480018			200/201 x 52
	1.6 D			89-K-120000	02.87		- ABS					
	1.6 TD			89-K-120000	04.88		- ABS					
	1.8	55		89-K-120000	09.86		- ABS					
	1.8	66		89-K-120000	09.86		- ABS					
	1.6		89-K-200001	8A-M-095094			- ABS	24.0220-0017.1	480053			200/201 x 52
	1.6 D		89-K-200001	8A-M-095094	07.89		- ABS					
	1.6 TD		89-K-200001	8A-M-095094			- ABS					
	1.8	55	89-K-200001	8A-M-095094			- ABS					
	1.8	66	89-K-200001	8A-M-095094			- ABS					
	1.9 D		89-K-200001	8A-M-095094	08.89		- ABS					
	1.6		8A-M-095095				- ABS	24.0220-0016.1	480018			200/201 x 52
	1.6 TD		8A-M-095095				- ABS					
	1.8	55	8A-M-095095				- ABS					
	1.8	66	8A-M-095095				- ABS					
	1.9 D		8A-M-095095				- ABS					
	1.6	55	89-K-200001	8A-M-080000			- ABS	03.0520-0415.3	690415			15,87/200x40 TopKit
	1.6 D		89-K-200001		07.89		- ABS					
	1.8	55	89-K-200001	8A-M-080000			- ABS/ + Schaltgetriebe ⁵⁾					
	1.6	51	89-K-200001	8A-M-080000			- ABS/ + Bremskraftregler ⁶⁾	03.0420-4219.3	684219			19,05/200x40 Kit
	1.6 TD		89-K-200001	8A-M-080000			- ABS	03.0520-4219.3	694219			19,05/200x40 TopKit
	1.8	55	89-K-200001	8A-M-080000			- ABS/ + Automatikgetriebe ⁷⁾					
	1.8	66	89-K-200001	8A-M-080000			- ABS					
	1.9 D		89-K-200001	8A-M-080000	08.89		- ABS					

¹⁾ on the brake caliper / sulla pinza freno / sur l'étrier de frein / a la pinza de freno

²⁾ - ABS/ - brake press.regulator / - ABS/ - correttore di frenata / - ABS/ - correcteur de freinage / - ABS/ - corrector de frenado

³⁾ + cast iron / + ghisa / + fonte grise / + fundición de gris

⁴⁾ + aluminium / + alluminio / + aluminium / + aluminio

⁵⁾ - ABS/ + manual transmission / - ABS/ + scatola camb.velocità / - ABS/ + transmission mécanique / - ABS/ + cambio de velocidad

⁶⁾ - ABS/ + brake press.regulator / - ABS/ + correttore di frenata / - ABS/ + correcteur de freinage / - ABS/ + corrector de frenado

⁷⁾ - ABS/ + autom.transmission / - ABS/ + scatola cambio autom. / - ABS/ + transmission automatique / - ABS/ + cambio automático

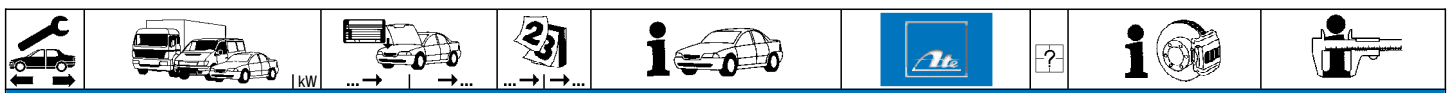

AUDI 80 (87-91)										
	1.6			09.86	07.91	24.3727-0128.2	580128	<input type="checkbox"/>		L=1345
	1.6 D			02.87	07.89	24.3727-0127.2	580127	<input type="checkbox"/>		L=1298
	1.6 TD			04.88	07.91					
	1.8	55		09.86	07.91					
	1.8	66		09.86	07.91					
	1.9 D			08.89	07.91					
	1.8	82		09.86	07.91	24.3727-0143.2	580143	<input type="checkbox"/>		L=1398
	1.9 E			09.86	07.88	24.3727-0144.2	580144	<input type="checkbox"/>		L=1358
2.0			08.88	07.91						
	1.6			09.86	07.91	03.6585-0108.3	320115			BRL 8/5 (4) ATE
	1.6 D			02.87	07.89					
	1.6 TD			04.88	07.91					
	1.8			09.86	07.91					
	1.9 D			08.89	07.91					
1.9 E			09.86	07.88						
2.0			08.88	07.91						
	1.6			09.86	07.91	03.2419-9210.3	030026			Gz 19,05
	1.6 D			02.87	07.89					
	1.6 TD			04.88	07.91					
	1.8			09.86	07.91					
	1.9 D			08.89	07.91					
1.9 E			09.86	07.88						
2.0			08.88	07.91						
	1.6			09.86	07.91	03.2522-4300.3	040085			Nz 22,20
	1.6 D			02.87	07.89					
	1.6 TD			04.88	07.91					
	1.8			09.86	07.91					
	1.9 D			08.89	07.91					
1.9 E			09.86	07.88						
2.0			08.88	07.91						

AUDI 80 (91-95)											
	1.6			8C-N-300000	08.91	03.7750-0302.4	300071			9" ATE	
	1.9 TD	55		8C-N-300000	09.91						
	1.9 TDI	66		8C-N-300000	09.91						
	2.0			8C-N-300000	08.91						
	2.3			8C-N-300000	09.91						
	1.6			8C-N-300000	08.91	- ABS	24.2122-1601.3	010380		THz 22,20 LUC	
	1.6			08.91	12.95	- ABS					
	1.9 TD	55		8C-N-300000	09.91	- ABS					
	1.9 TD	55		09.91	12.95	- ABS					
	1.9 TDI	66		8C-N-300000	09.91	- ABS					
	1.9 TDI	66		09.91	12.95	- ABS					
	2.0			8C-N-300000	08.91	- ABS					
	2.0			08.91	12.95	- ABS					
	2.3			8C-N-300000	09.91	- ABS					
	2.3			09.91	12.95	- ABS					
	1.6		8C-P-000001		12.95	- ABS	03.2123-0491.3	010167		THz 23,81 ATE	
	1.9 TD	55	8C-P-000001		12.95	- ABS					
	1.9 TDI	66	8C-P-000001		12.95	- ABS					
	2.0		8C-P-000001		12.95	- ABS					
	2.3		8C-P-000001		12.95	- ABS					
	1.6			08.91	12.95	+ ABS	24.2123-1602.3	010384		THz 23,81 LUC	
	1.9 TD	55		09.91	12.95	+ ABS					
	1.9 TDI	66		09.91	12.95	+ ABS					
	2.0			08.91	12.95	+ ABS/ - Hydraulikverstärker 1)					
	2.3			09.91	12.95	+ ABS					
	2.6			08.92	12.95	+ ABS/ - Hydraulikverstärker 1)					
2.8			09.91	12.95	+ ABS/ - Hydraulikverstärker 1)						
	2.0			08.91	12.95	+ ABS/ + Hydraulikverstärker 2)	03.2123-0566.3	010169		THz 23,81 ATE	
	2.6			07.92	12.95	+ ABS/ + Hydraulikverstärker 2)					
	2.8			09.91	12.95	+ ABS/ + Hydraulikverstärker 2)					
	1.6	52		8C-N-300000	08.91		24.3541-1610.5	240040	<input type="checkbox"/>	D=54, - Halter LUC	
	1.9 TD	55		8C-N-300000	08.91		24.3541-1609.5	240039	<input type="checkbox"/>	D=54, - Halter LUC	
	1.9 TDI	66		8C-N-300000	08.91		24.0101-4301.2	260047		Bremssattel-Zubehör LUC	
	2.0	66		8C-N-300000	08.91	+ Schaltgetriebe 3)	11.0101-5403.2	260010		Faltenbalgsatz LUC	
	1.6	52	8C-P-000001		07.93		24.3541-1743.5	240219	<input type="checkbox"/>	D=54, - Halter LUC	
	1.6	52			08.93	12.95	+ Schaltgetriebe 3)	24.3541-1744.5	240220	<input type="checkbox"/>	D=54, - Halter LUC
	1.9 TD	55	8C-P-000001		07.93						
	1.9 TD	55			08.93	12.95	+ Schaltgetriebe 3)				
	1.9 TDI	66	8C-P-000001		12.95						
	2.0	66	8C-P-000001		12.95	+ Schaltgetriebe 3)					
	1.6	52			08.93	12.95	+ Automatikgetriebe 4)	24.3541-1720.5	240058	<input type="checkbox"/>	D=54, - Halter LUC
	1.6	74			08.91	12.95	+ Automatikgetriebe 4)	24.3541-1719.5	240057	<input type="checkbox"/>	D=54, - Halter LUC
	1.9 TD	55			08.93	12.95	+ Automatikgetriebe 4)	24.0101-4301.2	260047		Bremssattel-Zubehör LUC
	1.9 TDI	66			08.93	12.95	+ Automatikgetriebe 4)	11.0101-5403.2	260010		Faltenbalgsatz LUC
	2.0	66			08.91	12.95	+ Automatikgetriebe 4)				
2.0	85			08.91	12.95						
2.0	101			08.91	07.92						
2.0	103			08.91	12.95						
2.3				09.91	12.95						
2.6				08.92	12.95						
2.8				09.91	12.95		24.0101-3401.2	260043		Bremssattel-Zubehör LUC	
							11.0101-5403.2	260010		Faltenbalgsatz LUC	

1) + ABS/ - hydraulic booster / + ABS/ - servofreno idraulico / + ABS/ - amplificateur hydraulique / + ABS/ - servo hidráulico
2) + ABS/ + hydraulic booster / + ABS/ + servofreno idraulico / + ABS/ + amplificateur hydraulique / + ABS/ + servo hidráulico
3) + manual transmission / + scatola cambio velocità / + transmission mécanique / + cambio de velocidad
4) + autom.transmission / + scatola cambio automatico / + transmission automatique / + cambio automático



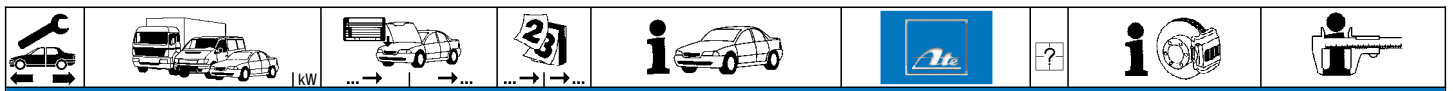





















AUDI 80 (91-95)										
	1.6 1.9 TD 1.9 TDI 2.0 2.3 2.6 2.8			08.91 12.95 09.91 12.95 08.91 12.95 09.91 12.95 07.92 12.95	12.95 12.95 12.95 12.95 12.95 12.95	13.0460-2934.2 13.0460-2925.2	602934 602925		20669 19,0 /S 20901 19,0 +/WK/S	LUC LUC
	1.6 1.9 TD 1.9 TDI 2.0	52 55 66 66	8C-P-000001 8C-P-000001 8C-P-000001 8C-P-000001	08.91 09.91 09.91 08.91		24.0113-0166.1	413166		21138 18,8 +/WK/S 256 13,0 11,0 +B	LUC
	1.6 1.9 TD 1.9 TDI 2.0	52 55 66 66	8C-P-000001 8C-P-000001 8C-P-000001 8C-P-000001	08.91 09.91 09.91 08.91	+ Schaltgetriebe ¹⁾	24.0113-0179.1	413179		280 13,0 11,0 L +B	
	1.6 2.0 2.0 2.0 2.3	74 66 85 101	8C-N-300000 8C-N-300000 8C-N-300000 8C-N-300000 8C-N-300000	08.91 08.91 08.91 08.91 09.91	+ Automatikgetriebe ²⁾	24.0122-0108.1	422108		256 22,0 20,0 V L +B	
	1.6 1.6 1.9 TD 2.0 2.0 2.0 2.0 2.0 2.3 2.6 2.8	52 74 55 66 85 101 103	8C-P-000001 8C-P-000001 8C-P-000001 8C-P-000001 8C-P-000001 8C-P-000001 8C-P-000001 8C-P-000001 8C-P-000001 8C-P-000001	08.91 12.95 12.95 12.95 12.95 07.92 12.95 12.95 12.95 08.92 12.95	+ Automatikgetriebe ²⁾ + Automatikgetriebe ²⁾ + Automatikgetriebe ²⁾	24.0122-0139.1	422139		280 22,0 20,0 V L +B	
	1.6 1.9 TD 1.9 TDI 2.0 2.3 2.6 2.8	55 66		08.91 12.95 09.91 12.95 08.91 12.95 09.91 12.95 07.92 12.95 09.91 12.95		24.5237-0288.3 24.5170-0161.3	331442 331308	2 2	am Bremssattel ³⁾	L=288 L=161
	1.6 1.6 1.9 TD 1.9 TD 1.9 TDI 1.9 TDI 2.0 2.0 2.0 2.0 2.3 2.6 2.8	8C-P-050001 55 55 66 66 66 66 85 101 103	8C-P-050000 8C-P-050000 8C-P-050000 8C-P-050000 8C-P-050000 8C-P-050000 8C-P-050000 8C-P-050000 8C-P-050000 8C-P-050000 8C-P-050000 8C-P-050000	08.91 12.95 09.91 09.91 09.91 08.91 08.91 08.91 08.91 08.91 09.91 08.92 09.91 12.95	+ ABS + ABS + ABS + ABS + ABS	24.3384-1701.5 24.3384-1702.5	240169 240170	<input type="checkbox"/> <input type="checkbox"/>	D=38, - Halter D=38, - Halter	LUC LUC
	1.6 1.6 1.9 TD 1.9 TD 1.9 TDI 1.9 TDI 2.0 2.0 2.0 2.0 2.3 2.6 2.8	8C-P-050001 55 55 66 66 66 66 85 101 103	8C-P-050000 8C-P-050000 8C-P-050000 8C-P-050000 8C-P-050000 8C-P-050000 8C-P-050000 8C-P-050000 8C-P-050000 8C-P-050000 8C-P-050000 8C-P-050000	08.91 12.95 09.91 09.91 09.91 08.91 08.91 08.91 08.91 08.91 09.91 08.92 09.91 12.95	+ ABS + ABS + ABS + ABS	13.0460-3602.2	603602		21144 15,8 /S	LUC
	1.6 1.6 1.9 TD 1.9 TD 1.9 TDI 1.9 TDI 2.0 2.0 2.0 2.0 2.3 2.6 2.8	8C-P-050001 55 55 66 66 66 66 85 101 103	8C-P-050000 8C-P-050000 8C-P-050000 8C-P-050000 8C-P-050000 8C-P-050000 8C-P-050000 8C-P-050000 8C-P-050000 8C-P-050000 8C-P-050000 8C-P-050000	08.91 12.95 09.91 09.91 09.91 08.91 08.91 08.91 08.91 08.91 09.91 08.92 09.91 12.95	+ ABS + ABS + ABS + ABS	24.0110-0178.1	410178		245 10,0 8,0 +B	
	1.6 1.9 TD 1.9 TDI 2.0	55 66 66	8C-P-050000 8C-P-050000 8C-P-050000 8C-P-050000	08.91 09.91 09.91 09.91	- ABS - ABS - ABS - ABS	83.7812-0200.3	330846	2		L=200
	1.6 1.6	8C-P-050001	8C-P-050000	08.91 12.95	+ ABS	83.7812-0200.3 83.7724-0202.3	330846 330852	2 2	am Bremssattel ³⁾	L=200 L=200

1) + manual transmission / + scatola cambio velocità / + transmission mécanique / + cambio de velocidad
 2) + autom.transmission / + scatola cambio automatico / + transmission automatique / + cambio automático
 3) on the brake caliper / sulla pinza freno / sur l'étrier de frein / a la pinza de freno



												
AUDI 80 (91-95)												
	1.9 TD 1.9 TD 1.9 TDI 1.9 TDI 2.0 2.0 2.0 2.0 2.0 2.3 2.6 2.8	55 55 66 66 66 85 101 103	8C-P-050001 8C-P-050001 8C-P-050001 8C-P-050001 8C-P-050001 8C-P-050001 8C-P-050001 8C-P-050001 8C-P-050001 8C-P-050001 8C-P-050001 8C-P-050001	8C-P-050000 8C-P-050000 8C-P-050000 8C-P-050000 8C-P-050000 8C-P-050000 8C-P-050000 8C-P-050000 8C-P-050000 8C-P-050000 8C-P-050000 8C-P-050000	09.91 09.91 09.91 08.91 12.95 08.91 08.91 08.91 08.91 08.91 08.91 08.91	+ ABS + ABS + ABS + ABS + ABS + ABS + ABS + ABS + ABS + ABS + ABS + ABS	83.7812-0200.3 83.7724-0202.3	330846 330852	2 2	am Bremsattel ¹⁾	L=200 L=200	
	1.6 1.9 TD 1.6 1.9 TDI 2.0 1.6 1.9 TDI 2.0	52 55 74 66 74 66 74 66	8C-P-050000 8C-P-050000 8C-N-300000 8C-N-300000 8C-N-300000 8C-P-000001 8C-P-000001 8C-P-000001	8C-P-050000 8C-P-050000 8C-N-300000 8C-N-300000 8C-N-300000 8C-P-050000 8C-P-050000 8C-P-050000	08.91 09.91 08.91 08.91 08.91 08.91 08.91 08.91	- ABS - ABS - ABS - ABS - ABS - ABS - ABS - ABS	03.3217-2112.3 24.3217-0908.3 24.3219-0909.3 24.3219-0909.3 24.3219-0909.3 24.3220-0909.3 24.3220-0909.3 24.3220-0909.3	020027 020167 020188 020188 020210 020210 020210 020210		+ GG ²⁾ + ALU ³⁾	Rz 17,46 Rz 17,46 Rz 19,05 Rz 19,05 Rz 20,64 Rz 20,64 Rz 20,64 Rz 20,64	
	1.6 1.9 TD 1.9 TDI 2.0	55 66 66	8C-P-050000 8C-P-050000 8C-P-050000 8C-P-050000	8C-P-050000 8C-P-050000 8C-P-050000 8C-P-050000	08.91 08.91 09.91 08.91	- ABS - ABS - ABS - ABS	03.0137-0264.2 03.0137-9164.2	650264 669164			230 x 40 HEB Bremsbacken-Zubehör	VW
	1.6 1.9 TD 1.9 TDI 2.0	55 66 66	8C-P-050000 8C-P-050000 8C-P-050000 8C-P-050000	8C-P-050000 8C-P-050000 8C-P-050000 8C-P-050000	08.91 09.91 09.91 08.91	- ABS - ABS - ABS - ABS	24.0223-0007.1	480037			230/231 x 46	
	1.6 1.9 TDI 2.0	74 66 66	8C-P-000001 8C-P-000001 8C-P-000001	8C-P-050000 8C-P-050000 8C-P-050000	08.91 08.91 08.91	- ABS - ABS - ABS	03.0520-6120.3	696120			20,64/230x40 TopKit	VW
	1.6 1.9 TD 1.9 TDI 2.0	55 66 66	8C-P-050000 8C-P-050000 8C-P-050000 8C-P-050000	8C-P-050000 8C-P-050000 8C-P-050000 8C-P-050000	08.91 09.91 09.91 08.91	- ABS - ABS - ABS - ABS	24.3727-0148.2	580148	2	+ HA-Trommelbremse ⁴⁾	L=1578	
	1.6 1.6 1.9 TD 1.9 TD 1.9 TDI 1.9 TDI 2.0 2.0 2.0 2.0 2.0 2.0 2.3 2.6 2.8	55 55 66 66 66 66 85 101 103	8C-P-050001 8C-P-050001 8C-P-050001 8C-P-050001 8C-P-050001 8C-P-050001 8C-P-050001 8C-P-050001 8C-P-050001 8C-P-050001 8C-P-050001 8C-P-050001 8C-P-235351 8C-P-235351 8C-P-235351 8C-P-235351 8C-P-235351 8C-P-235351 8C-P-235351 8C-P-235351 8C-P-235351 8C-P-235351 8C-P-235351	8C-P-235351 8C-P-050000 8C-P-235351 8C-P-050000 8C-P-235351 8C-P-050000 8C-P-235351 8C-P-050000 8C-P-235351 8C-P-050000 8C-P-235351 8C-P-050000 8C-P-235351 8C-P-235351 8C-P-235351 8C-P-235351 8C-P-235351 8C-P-235351 8C-P-235351 8C-P-235351 8C-P-235351 8C-P-235351	09.91 09.91	+ ABS + ABS	24.3727-0147.2	580147	2	+ HA-Scheibenbremse ⁵⁾	L=1722	
	1.6 1.9 TD 1.9 TDI 2.0 2.0 2.0 2.0 2.0 2.0 2.3 2.6 2.8	55 66 66 85 101 103	8C-P-235352 8C-P-235352 8C-P-235352 8C-P-235352 8C-P-235352 8C-P-235352 8C-P-235352 8C-P-235352 8C-P-235352 8C-P-235352 8C-P-235352 8C-P-235352	8C-P-235352 8C-P-235352 8C-P-235352 8C-P-235352 8C-P-235352 8C-P-235352 8C-P-235352 8C-P-235352 8C-P-235352 8C-P-235352 8C-P-235352 8C-P-235352	12.95 12.95 12.95 12.95 12.95 07.92 12.95 12.95 12.95 12.95 12.95 12.95		24.3727-0191.2 24.3727-0192.2	580191 580192		+ HA-Scheibenbremse ⁵⁾ + HA-Scheibenbremse ⁵⁾	L=1723 L=1723	
	1.6 1.9 TD 1.9 TDI 2.0 2.3 2.6 2.8	55 66	8C-P-050000 8C-P-050000	8C-P-050000 8C-P-050000	08.91 09.91 09.91 08.91 09.91 07.92 09.91		03.6584-0107.3	320110			BRL 8/4 (4)	ATE
	1.6 1.9 TD 1.9 TDI 2.0 2.3 2.6 2.8	55 66	8C-P-050000 8C-P-050000	8C-P-050000 8C-P-050000	08.91 09.91 09.91 08.91 09.91 07.92 09.91		03.2419-9210.3	030026			Gz 19,05	
	1.6 1.9 TD 1.9 TDI 2.0 2.3 2.6 2.8	55 66	8C-P-050000 8C-P-050000	8C-P-050000 8C-P-050000	08.91 09.91 09.91 08.91 09.91 07.92 09.91		03.2522-4300.3	040085			Nz 22,20	









































¹⁾ on the brake caliper / sulla pinza freno / sur l'étrier de frein / a la pinza de freno

²⁾ + cast iron / + ghisa / + fonte grise / + fundición de gris

























³⁾ + aluminium / + alluminio / + aluminium / + aluminio

⁴⁾ + RA drum brake / + P freno a tamburo / + frein à tambour essieu AR / + ET-tambores de freno

























⁵⁾ + RA disc brake / + P disco freno / + frein à disque essieu AR / + ET-disco de freno

											
AUDI 80 Quattro (78-86)											
	1.8 2.2			08.84 08.84	08.86 08.86	03.7750-0302.4	300071	9"	ATE		
	2.0 2.2			08.83 08.82	07.84 07.84	03.2122-8012.3	010156	THz 22,20	ATE		
	1.8 2.0 2.2			08.84 08.84 08.82	08.86 08.86 08.86	03.2122-9612.3	010159	THz 22,20	ATE		
	1.8 2.0 2.2			08.84 08.83 08.82	08.86 07.84 08.86	24.3541-1610.5 24.3541-1609.5 24.0101-4301.2 11.0101-5403.2	240040 240039 260047 260010	 	D=54, - Halter D=54, - Halter Bremsattel-Zubehör Fallenbalgsatz	LUC LUC LUC LUC	
	1.8 2.0 2.2			08.84 08.83 08.82	08.86 07.84 08.86	13.0460-2926.2	602926	20669	15,7 /S	LUC	
	1.8 2.0 2.2			08.84 08.83 08.82	08.86 07.84 08.86	24.0120-0120.1	420120		256 20,0 18,0 V L		
	1.8 2.0 2.2			08.84 08.83 08.82	08.86 07.84 08.86	24.5170-0315.3	331309	2	L=315		
	1.8 2.0 2.2	85-E-000001 85-E-000001		08.84 08.83 08.82	08.86 07.84 08.86	24.0101-3601.2	260044		Bremsattel-Zubehör	LUC	
	1.8 2.0 2.2			08.84 08.83 08.82	08.86 07.84 08.86	13.0460-3602.2	603602		21144	15,8 /S	LUC
	1.8 2.0 2.2			08.84 08.83 08.82	08.86 07.84 08.86	24.0110-0182.1	410182		245 10,0 8,0 +B		
	2.2		85-D-250000	08.82		24.5170-0315.3	331309	2	L=315		
	1.8 2.0 2.2	85-E-000001 85-E-000001		08.84 08.83 08.82	08.86 07.84 08.86	83.6104-0250.3	330720	2	L=250		
	1.8 2.0 2.2			08.84 08.83 08.82	08.86 07.84 08.86	03.6058-0301.3	320072		BR 25/5 (3)	ATE	
	1.8 2.0 2.2			08.84 08.83 08.82	08.86 07.84 08.86	03.2419-8150.3	030019		Gz 19,05		
	1.8 2.0 2.2			08.84 08.83 08.82	08.86 07.84 08.86	03.2522-4211.3	040017		Nz 22,20		
AUDI 80 Quattro (87-91)											
	1.8 1.9 E 2.0			09.86 09.86 08.88	09.91 07.88 09.91	03.7750-0302.4	300071		9"	ATE	
	1.8 1.9 E 2.0			09.86 09.86 08.88	09.91 07.88 09.91	03.2122-9612.3	010159		THz 22,20	ATE	
	1.8 1.9 E 2.0			09.86 09.86 08.88	09.91 07.88 09.91	24.2122-1601.3	010380		THz 22,20	LUC	
	1.8 1.9 E 2.0			09.86 09.86 08.88	09.91 07.88 09.91	03.2123-0566.3 03.3517-0101.2	010169 390322		THz 23,81 Verschlusschraube	ATE	
	1.8 1.9 E 2.0	66		09.86 09.86 08.88	09.91 07.88 09.91	24.3541-1610.5 24.3541-1609.5 11.0441-5405.2 11.0101-5409.2 24.0101-4301.2 11.0101-5403.2	240040 240039 250030 260035 260047 260010	 	D=54, - Halter D=54, - Halter Dichtungssatz Hülssensatz Bremsattel-Zubehör Fallenbalgsatz	LUC LUC ATE ATE LUC LUC	
	1.8 1.9 E 2.0	82		09.86 09.86 08.88	09.91 07.88 09.91	11.3541-8521.2 24.3541-1720.5 24.3541-1719.5 11.0441-5405.2 11.0101-5409.2 24.0101-4301.2 11.0101-5403.2	220113 240058 240057 250030 260035 260047 260010	  	D=54, - Halter D=54, - Halter D=54, - Halter Dichtungssatz Hülssensatz Bremsattel-Zubehör Fallenbalgsatz	ATE LUC LUC ATE ATE LUC LUC	
	1.8 1.9 E 2.0	66		09.86 09.86 08.88	09.91 07.88 09.91	13.0460-2934.2	602934		20669	19,0 /S	LUC
	1.8 1.9 E 2.0	66 82		09.86 09.86 08.88	09.91 07.88 09.91	24.0113-0160.1 24.0122-0118.1	413160 422118		256 13,0 11,0 +B 256 22,0 20,0 V +B		
	1.8 1.9 E 2.0		8A-L-030000	09.86 09.86 08.88	09.91 07.88 08.88	24.5170-0315.3	331309	2	L=315		
	1.8 2.0	8A-L-030001 8A-L-030001		09.91 09.91	09.91 09.91	24.5237-0288.3 24.5170-0161.3	331442 331308	2 2	am Bremsattel ¹⁾	L=288 L=161	

¹⁾ on the brake caliper / sulla pinza freno / sur l'étrier de frein / a la pinza de freno

								
AUDI 80 Quattro (87-91)								
	1.8 1.9 E		89-J-240000 89-J-240000	09.86 09.86		24.0101-3601.2	260044	Bremssattel-Zubehör LUC
	1.8 1.9 E 2.0	89-J-240001 89-J-240001		09.91 07.88 08.88		24.3384-1703.5 24.3384-1704.5 24.0101-3601.2	240055 240056 260044	D=38, - Halter LUC D=38, - Halter LUC Bremssattel-Zubehör LUC
	1.8 1.9 E 2.0			09.86 09.86 08.88	09.91 07.88 09.91	13.0460-3602.2	603602	21144 15,8 /S LUC
	1.8 1.9 E 2.0			09.86 09.86 08.88	09.91 07.88 09.91	24.0110-0182.1	410182	245 10,0 8,0 +B
	1.8 1.9 E 2.0			09.86 09.86 08.88	09.91 07.88 09.91	83.6104-0250.3	330720	L=250
	1.8 1.9 E 2.0			09.86 09.86 08.88	09.91 07.88 09.91	03.2419-9210.3	030026	Gz 19,05
	1.8 1.9 E 2.0			09.86 09.86 08.88	09.91 07.88 09.91	03.2522-4300.3	040085	Nz 22,20
AUDI 80 Quattro (92-95)								
	2.0 2.3			09.91 09.91	12.95 12.95	03.7750-0302.4	300071	9" ATE
	RS 2 S2	232 169	8C-S-000368	03.94 02.93	12.95	10.0124-3202.3	340011	Hydraulik Verstärker
	2.0 2.3		8C-N-300000 8C-N-300000	09.91 09.91		24.2122-1601.3	010380	THz 22,20 LUC
	2.0 2.0	8C-P-000001 8C-P-000001		12.95 12.95		03.2123-0491.3	010167	THz 23,81 ATE
	RS 2 RS 2 S2	232 232 169	8C-S-000368	03.94 03.94 02.93	07.95 12.95	03.2125-3610.3	010214	THz 25,40 ATE
	2.0 2.6 2.8			09.91 08.92 09.91	12.95 12.95 12.95	03.2123-0566.3	010169	THz 23,81 ATE
	2.0 2.3 2.6			09.91 09.91 08.92	12.95 12.95 12.95	24.3541-1720.5 24.3541-1719.5 24.0101-4301.2 11.0101-5403.2	240058 240057 260047 260010	D=54, - Halter LUC D=54, - Halter LUC Bremssattel-Zubehör LUC Fallenbalgsatz LUC
	2.8 S2	169		09.91 02.93	12.95 12.95	24.0101-3401.2 11.0101-5403.2	260043 260010	Bremssattel-Zubehör LUC Fallenbalgsatz LUC
	2.0 2.3 2.6			09.91 09.91 08.92	12.95 12.95 12.95	13.0460-2934.2	602934	20669 19,0 /S LUC
	2.8 S2	169		09.91 02.93	12.95 12.95	13.0460-2963.2	602963	21138 18,8 +/WK/S LUC
	2.0 2.3		8C-N-300000 8C-N-300000	09.91 09.91		24.0122-0108.1	422108	256 22,0 20,0 V L +B
	2.0 2.3 2.6	8C-P-000001 8C-P-000001		12.95 12.95 08.92	12.95	24.0122-0139.1	422139	280 22,0 20,0 V L +B
	2.8 S2	169		09.91 02.93	12.95 12.95	24.0125-0106.1 24.0125-0139.1	425106 425139	276 25,0 23,0 V L +B 276 24,9 23,0 V L +B
	2.0 2.3 2.6 2.8 RS 2 S2	232 169		09.91 09.91 08.92 09.91 03.94 02.93	12.95 12.95 12.95 12.95 07.95 12.95	24.5237-0288.3 24.5170-0161.3	331442 331308	2 2 am Bremssattel 1) L=288 L=161
	2.0 2.3 2.6 2.8 S2	169		09.91 09.91 08.92 09.91 02.93	12.95 12.95 12.95 12.95 12.95	13.0460-3602.2	603602	21144 15,8 /S LUC
	2.0 2.3 2.6 2.8 S2	169		09.91 09.91 08.92 09.91 02.93	12.95 12.95 12.95 12.95 12.95	24.0110-0182.1	410182	245 10,0 8,0 +B
						24.0110-0261.1 24.0310-0261.1	410261 510261	245 10,0 8,0 +B 245 10,0 8,0 +B PD
	2.0 2.3 2.6 2.8 RS 2 S2	232 169		09.91 09.91 08.92 09.91 03.94 02.93	12.95 12.95 12.95 12.95 07.95 12.95	83.6212-0160.3 24.5113-0220.3	330318 331318	2 2 am Bremssattel 1) L=160 L=220
	2.0 2.3 2.6 2.8			09.91 09.91 08.92 09.91	12.95 12.95 12.95 12.95	03.2419-9210.3	030026	Gz 19,05

1) on the brake caliper / sulla pinza freno / sur l'étrier de frein / a la pinza de freno

AUDI 80 Quattro (92-95)								
	2.0 2.3 2.6 2.8 RS 2 S2	232 169	09.91 09.91 08.92 09.91 03.94 02.93	12.95 12.95 12.95 12.95 07.95 12.95	03.2522-4300.3	040085		Nz 22,20
AUDI 90 (85-87)								
	1.6 TD 2.0 2.2		10.84 10.84 10.84	03.87 03.87 03.87	03.7750-0302.4	300071		9" ATE
	1.6 TD 2.0 2.2		10.84 10.84 10.84	03.87 03.87 03.87	03.2120-2331.3	010110	Kompakt-THz 2)	THz 20,64 ATE
	1.6 TD 2.0 2.2		10.84 10.84 10.84	03.87 03.87 03.87	03.2122-9612.3	010159		THz 22,20 ATE
	1.6 TD 2.0 2.2		10.84 10.84 10.84	03.87 03.87 03.87	24.3541-1610.5 24.3541-1609.5 24.0101-4301.2 11.0101-5403.2	240040 240039 260047 260010	<input type="checkbox"/> <input type="checkbox"/>	D=54, - Halter D=54, - Halter Bremsattel-Zubehör Faltenbalgsatz
	1.6 TD 2.0 2.2		10.84 10.84 10.84	03.87 03.87 03.87	13.0460-2926.2	602926		20669 15,7 / S LUC
	1.6 TD 2.0 2.2		10.84 10.84 10.84	03.87 03.87 03.87	24.0120-0120.1	420120		256 20,0 18,0 V L
	1.6 TD 2.0 2.2		10.84 10.84 10.84	03.87 03.87 03.87	24.5170-0315.3	331309	2	L=315
	2.2	100	10.84	03.87	24.0101-3601.2	260044		Bremsattel-Zubehör LUC
	2.2	100	10.84	03.87	13.0460-3602.2	603602		21144 15,8 / S LUC
	2.2	100	10.84	03.87	24.0110-0178.1	410178		245 10,0 8,0 +B
	1.6 TD 2.0 2.2	85	10.84 10.84 01.85	03.87 03.87 03.87	83.6224-0200.3 83.7804-0150.3	330729 330853	<input type="checkbox"/> <input type="checkbox"/>	L=200 L=150
	1.6 TD 2.0 2.2	100	10.84	03.87	83.6224-0200.3 83.7804-0150.3 24.5170-0161.3	330729 330853 331308	2 <input type="checkbox"/> <input type="checkbox"/>	L=200 L=150 L=161 am Bremsattel 4)
	1.6 TD 2.0 2.2	85	10.84 10.84 01.85	03.87 03.87 03.87	03.3217-2112.3 24.3217-0908.3	020027 020167	<input type="checkbox"/> <input type="checkbox"/>	+ GG 5) + ALU 6)
	1.6 TD 2.0 2.2	85	10.84 10.84 01.85	03.87 03.87 03.87	03.0137-0146.2 03.0137-9041.2	650146 669041		200 x 40 HEB Bremsbacken-Zubehör
	1.6 TD 2.0 2.2	85	10.84 10.84 01.85	03.87 03.87 03.87	24.0220-0016.1	480018		200/201 x 52
	1.6 TD 2.0 2.2	85	10.84 10.84 01.85	03.87 03.87 03.87	03.0420-0417.3	680417		17,46/200x40 Kit VW
	1.6 TD 2.0 2.2	85	10.84 10.84 01.85	03.87 03.87 03.87	24.3727-0136.2 24.3727-0139.2	580136 580139	<input type="checkbox"/> <input type="checkbox"/>	L=1195 L=1150
	1.6 TD 2.0 2.2		10.84 10.84 10.84	03.87 03.87 03.87	03.6565-0101.3	320097		BRL 6/5 (4) ATE
	1.6 TD 2.0 2.2		10.84 10.84 10.84	03.87 03.87 03.87	03.6585-0108.3	320115		BRL 8/5 (4) ATE
	1.6 TD 2.0 2.2		10.84 10.84 10.84	03.87 03.87 03.87	03.2419-8150.3	030019		Gz 19,05
	1.6 TD 2.0 2.2		10.84 10.84 10.84	03.87 03.87 03.87	03.2522-4211.3	040017		Nz 22,20
AUDI 90 (87-91)								
	1.6 TD 1.8 2.0 2.2 2.3		04.88 08.89 04.87 04.87 04.87	07.91 07.91 07.91 07.91 07.91	03.7750-0302.4	300071		9" ATE
	2.0 2.2 2.3		04.87 04.87 04.87	07.91 07.91 07.91	10.0124-3202.3	340011		Hydraulik Verstärker

1) - heavy duty brake / - freno rinforzato / - frein renforcé / - freno reforzado
2) compact TMC / PFT compatta / MCT compact / CMT compacto
3) + heavy duty brake / + freno rinforzato / + frein renforcé / + freno reforzado
4) on the brake caliper / sulla pinza freno / sur l'étrier de frein / a la pinza de freno
5) + cast iron / + ghisa / + fonte grise / + fundición de gris
6) + aluminium / + alluminio / + aluminium / + aluminio

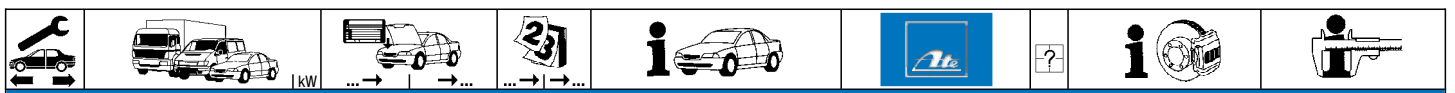

AUDI 90 (87-91)											
	1.6 TD			04.88	07.91	- ABS	03.2122-9612.3	010159		Thz 22,20	ATE
	1.8			08.89	07.91	- ABS					
	2.0			04.87	07.91	- ABS/ - Hydraulikverstärker ¹⁾					
	2.2			04.87	07.91	- ABS/ - Hydraulikverstärker ¹⁾					
	2.3	100		04.87	07.91	- ABS/ - Hydraulikverstärker ¹⁾					
	1.6 TD			04.88	07.91	+ ABS	24.2122-1601.3	010380		Thz 22,20	LUC
	1.8			08.89	07.91	+ ABS					
	2.0			04.87	07.91	+ ABS/ - Hydraulikverstärker ²⁾					
	2.2			04.87	07.91	+ ABS/ - Hydraulikverstärker ²⁾					
	2.3	100		04.87	07.91	+ ABS/ - Hydraulikverstärker ²⁾					
	2.0			04.87	07.91	+ Hydraulikverstärker ³⁾	03.2123-0566.3	010169		Thz 23,81	ATE
	2.2			04.87	07.91	+ Hydraulikverstärker ³⁾					
	2.3	100		04.87	07.91	+ Hydraulikverstärker ³⁾					
	2.3	125		08.88	07.91						
	1.8			08.89	07.91						
	2.0			04.87	07.91		11.3541-8521.2	220113		D=54, - Halter	ATE
	2.2			04.87	07.91						
	2.3	100		04.87	07.91						
	2.3	125	8A-L-038657	07.91							
	1.6 TD			04.88	07.91						
	1.8			08.89	07.91						
	2.0			04.87	07.91						
	2.2			04.87	07.91						
	2.3			04.87	07.91						
	2.3			04.87	07.91						
	1.6 TD			04.88	07.91		13.0460-2934.2	602934		20669	19,0 /S
	1.8			08.89	07.91						
	2.0			04.87	07.91						
	2.2			04.87	07.91						
	2.3	100		04.87	07.91						
	2.3	125		08.88	07.91		13.0460-2963.2	602963		21138	18,8 +/WK/S
	1.8			08.89	07.91						
	2.0			04.87	07.91						
	2.2			04.87	07.91						
	2.3	100		04.87	07.91						
	1.6 TD			04.88	07.91		24.0113-0160.1	413160		256	13,0 11,0 +B
	1.8			08.89	07.91						
	2.0			04.87	07.91						
	2.2			04.87	07.91						
	2.3	100		04.87	07.91						
	1.6 TD		8A-L-038656	04.88			24.5170-0315.3	331309	2		L=315
	1.8		8A-L-038656	08.89							
	2.0		8A-L-038656	04.87							
	2.2		8A-L-038656	04.87							
	2.3	100	8A-L-038656	04.87							
	2.3	125	8A-L-038656	08.88							
	1.6 TD	8A-L-038657		07.91							
	1.8	8A-L-038657		07.91							
	2.0	8A-L-038657		07.91							
	2.2	8A-L-038657		07.91							
2.3	8A-L-038657		07.91								
	1.6 TD		89-J-225956	04.88		+ ABS	24.0101-3601.2	260044			Bremsattel-Zubehör
	2.0		89-J-225956	04.87							
	2.2		89-J-225956	04.87							
	2.3		89-J-225956	04.87							
	1.6 TD	89-J-221810		07.91		+ ABS					
	1.8			08.89	07.91		24.3384-1601.5	240013		D=38, - Halter	LUC
	2.0			08.89	07.91						
	2.2	89-J-221810		07.91							
	2.3	89-J-221810		07.91							
	2.3	89-J-221810		07.91							
	1.6 TD			04.88	07.91	+ ABS	13.0460-3602.2	603602		21144	15,8 /S
	1.8			08.89	07.91						
	2.0			04.87	07.91						
	2.2			04.87	07.91						
	2.3			04.87	07.91						
	1.6 TD			04.88	07.91	+ ABS	24.0110-0178.1	410178		245	10,0 8,0 +B
	1.8			08.89	07.91						
	2.0			04.87	07.91						
	2.2			04.87	07.91						
	2.3			04.87	07.91						
	1.6 TD			04.88	07.91		83.6224-0200.3	330729		L=200	
	1.8			08.89	07.91						
	2.0			04.87	07.91						
	2.2			04.87	07.91						
	2.3			04.87	07.91						
	1.6 TD			04.88	07.91	- ABS	24.3219-0909.3	020188			Rz 19,05
	1.8			08.89	07.91						
	2.0			04.87	07.91						
	2.2			04.87	07.91						
	2.3			04.87	07.91						
	1.6 TD		89-K-200000	04.88		- ABS	03.0137-0146.2	650146		200 x 40	HEB
	1.6 TD	89-K-200001	8A-M-080000			- ABS					
	1.6 TD	8A-M-080001		07.91		- ABS					
	1.6 TD					- ABS	03.0137-9041.2	669041		200 x 40	HEB
	1.6 TD					- ABS					
	1.6 TD					- ABS					
	1.6 TD					- ABS	03.0137-0268.2	650268		200 x 40	HEB
	1.6 TD					- ABS					
	1.6 TD					- ABS					
	1.6 TD					- ABS	03.0137-9168.2	669168		200 x 40	HEB
	1.6 TD					- ABS					
	1.6 TD					- ABS					
	1.6 TD					- ABS	03.0137-0146.2	650146		200 x 40	HEB
	1.6 TD					- ABS					
	1.6 TD					- ABS					

1) - ABS/ - hydraulic booster / - ABS/ - servofreno idraulico / - ABS/ - amplificateur hydraulique / - ABS/ - servo hidráulico
2) + ABS/ - hydraulic booster / + ABS/ - servofreno idraulico / + ABS/ - amplificateur hydraulique / + ABS/ - servo hidráulico
3) + hydraulic booster / + servofreno idraulico / + amplificateur hydraulique / + servo hidráulico
4) on the brake caliper / sulla pinza freno / sur l'étrier de frein / a la pinza de freno



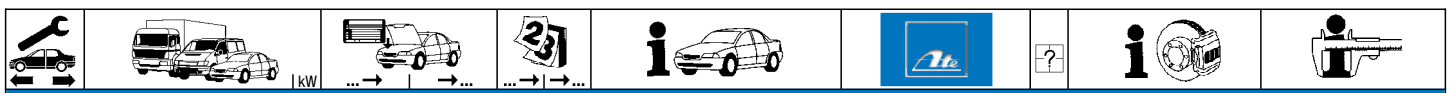

AUDI 90 (87-91)										
	1.6 TD		89-K-120000	04.88		- ABS	24.0220-0016.1	480018		200/201 x 52
	1.6 TD		89-K-120001	8A-M-095094		- ABS	24.0220-0017.1	480053		200/201 x 52
	1.6 TD		8A-M-095095		07.91	- ABS	24.0220-0016.1	480018		200/201 x 52
	1.6 TD		89-K-200001	8A-M-080000		- ABS	03.0420-4219.3	684219		19,05/200x40 Kit 19,05/200x40 TopKit
							03.0520-4219.3	694219		VW VW
	1.8			08.89	07.91		24.3727-0143.2	580143	<input type="checkbox"/>	L=1398
	2.0			04.87	07.91		24.3727-0144.2	580144	<input type="checkbox"/>	L=1358
	2.2			04.87	07.91					
	2.3			04.87	07.91					
	1.6 TD			04.88	07.91		24.3727-0128.2	580128	<input type="checkbox"/>	L=1345
							24.3727-0127.2	580127	<input type="checkbox"/>	L=1298
	1.6 TD			04.88	07.89		03.6585-0108.3	320115		BRL 8/5 (4)
	1.8			08.89	07.91					
	2.0	85		04.87	07.89					
	2.2			04.87	07.89					
	2.3	100		04.87	07.89					
	1.6 TD			04.88	07.91		03.2419-9210.3	030026		Gz 19,05
	1.8			08.89	07.91					
	2.0			04.87	07.91					
	2.2			04.87	07.91					
	2.3			04.87	07.91					
	1.6 TD			04.88	07.91		03.2522-4300.3	040085		Nz 22,20
	1.8			08.89	07.91					
	2.0			04.87	07.91					
	2.2			04.87	07.91					
	2.3			04.87	07.91					

AUDI 90 Quattro (84-87)										
	2.2			08.84	03.87		03.7750-0302.4	300071		9"
	2.2			08.84	03.87		03.2122-9612.3	010159		Thz 22,20
	2.2			08.84	03.87		24.3541-1610.5	240040	<input type="checkbox"/>	D=54, - Halter
							24.3541-1609.5	240039	<input type="checkbox"/>	D=54, - Halter
							24.0101-4301.2	260047		Bremssattel-Zubehör
							11.0101-5403.2	260010		Faltenbalsatz
	2.2			08.84	03.87		13.0460-2926.2	602926		20669 15,7 /S
	2.2			08.84	03.87		24.0120-0120.1	420120		256 20,0 18,0 V L
	2.2			08.84	03.87		24.5170-0315.3	331309	2	L=315
	2.2			08.84	03.87		24.0101-3601.2	260044		Bremssattel-Zubehör
	2.2			08.84	03.87		13.0460-3602.2	603602		21144 15,8 /S
	2.2			08.84	03.87		24.0110-0182.1	410182		245 10,0 8,0 +B
	2.2			08.84	03.87		83.6104-0250.3	330720	2	L=250
	2.2			08.84	03.87		03.6058-0301.3	320072		BR 25/5 (3)
	2.2			08.84	03.87		03.2419-8150.3	030019		Gz 19,05
	2.2			08.84	03.87		03.2522-4211.3	040017		Nz 22,20

AUDI 90 Quattro (87-91)										
	2.0			01.88	09.91		03.7750-0302.4	300071		9"
	2.2			04.87	09.91					
	2.3			04.87	09.91					
	2.0			01.88	09.91		10.0124-3202.3	340011		Hydraulik Verstärker
	2.2			04.87	09.91					
	2.3	100		04.87	09.91					
	2.3	125		06.88	09.91					
	2.0			01.88	09.91	- ABS/ - Hydraulikverstärker ¹⁾	03.2122-9612.3	010159		Thz 22,20
	2.2			04.87	09.91	- ABS/ - Hydraulikverstärker ¹⁾				
	2.3	100		04.87	09.91	- ABS/ - Hydraulikverstärker ¹⁾				
	2.3	125		06.88	09.91	- ABS/ - Hydraulikverstärker ¹⁾				
	2.0			01.88	09.91	+ ABS/ - Hydraulikverstärker ²⁾	24.2122-1601.3	010380		Thz 22,20

¹⁾ - ABS/ - hydraulic booster / - ABS/ - servofreno idraulico / - ABS/ - amplificateur hydraulique / - ABS/ - servo hidráulico
²⁾ + ABS/ - hydraulic booster / + ABS/ - servofreno idraulico / + ABS/ - amplificateur hydraulique / + ABS/ - servo hidráulico



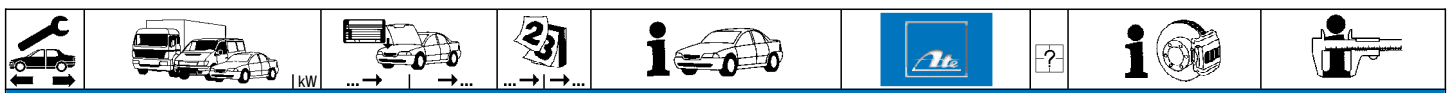





























AUDI 90 Quattro (87-91)											
	2.2			04.87	09.91	+ ABS/ - Hydraulikverstärker 1)	24.2122-1601.3	010380		Thz 22,20	LUC
	2.3	100		04.87	09.91	+ ABS/ - Hydraulikverstärker 1)					
	2.3	125		06.88	09.91	+ ABS/ - Hydraulikverstärker 1)					
	2.0			01.88	09.91	+ Hydraulikverstärker 2)	03.2123-0566.3	010169		Thz 23,81	ATE
	2.2			04.87	09.91	+ Hydraulikverstärker 2)					
	2.3	100		04.87	09.91	+ Hydraulikverstärker 2)					
	2.3	125		06.88	09.91	+ Hydraulikverstärker 2)	03.2125-3210.3	010212		Thz 25,40	ATE
	2.0			01.88	09.91		11.3541-8521.2	220113		D=54, - Halter	ATE
	2.2			04.87	09.91		24.3541-1720.5	240058		D=54, - Halter	LUC
2.3	100		04.87	09.91		24.3541-1719.5	240057	D=54, - Halter		LUC	
						11.0441-5405.2	250030	Dichtungssatz		ATE	
						11.0101-5409.2	260035	Hülssensatz		ATE	
						24.0101-4301.2	260047	Bremssattel-Zubehör		LUC	
						11.0101-5403.2	260010	Faltenbalsatz		LUC	
	2.3	125	8A-L-045363		09.91		24.0101-3401.2	260043		Bremssattel-Zubehör	LUC
	2.0			01.88	09.91		13.0460-2934.2	602934		20669 19,0 /S	LUC
	2.2			04.87	09.91						
	2.2			04.87	09.91						
	2.3	100		04.87	09.91						
	2.3	125		06.88	09.91		13.0460-2963.2	602963		21138 18,8 +/-WK/S	LUC
	2.0			01.88	09.91		24.0122-0118.1	422118		256 22,0 20,0 V +B	
	2.2			04.87	09.91						
	2.3	100		04.87	09.91						
	2.2			04.87	09.91						
	2.3	100		04.87	09.91						
	2.2		8A-L-030000	04.87			24.5170-0315.3	331309	2	L=315	
	2.3	100	8A-L-030000	04.87							
	2.3	125	8A-L-030000	06.88			24.5113-0380.3	331344	2	L=382	
	2.0			01.88	09.91		24.5237-0288.3	331442	2	L=288	
	2.2		8A-L-030001	09.91			24.5170-0161.3	331308	2	L=161	
	2.3		8A-L-030001	09.91						am Bremssattel 3)	
	2.2		89-J-240000	04.87			24.0101-3601.2	260044		Bremssattel-Zubehör	LUC
	2.3		89-J-240000	04.87							
	2.0			01.88	09.91		24.3384-1703.5	240055		D=38, - Halter	LUC
2.2		89-J-240001	09.91			24.3384-1704.5	240056	D=38, - Halter		LUC	
2.3		89-J-240001	09.91			24.0101-3601.2	260044	Bremssattel-Zubehör		LUC	
	2.0			01.88	09.91		13.0460-3602.2	603602		21144 15,8 /S	LUC
	2.2			04.87	09.91						
	2.3			04.87	09.91						
	2.0			01.88	09.91		24.0110-0182.1	410182		245 10,0 8,0 +B	
	2.2			04.87	09.91						
	2.3			04.87	09.91						
	2.0			01.88	09.91		83.6104-0250.3	330720	2	L=250	
	2.2			04.87	09.91						
	2.3			04.87	09.91						
	2.0			01.88	09.91		03.2419-9210.3	030026		Gz 19,05	
	2.2			04.87	09.91						
	2.3			04.87	09.91						
	2.0			01.88	09.91		03.2522-4300.3	040085		Nz 22,20	
	2.2			04.87	09.91						
	2.3			04.87	09.91						

AUDI 100 (68-76)											
	1.7			01.71	09.74	+ Schaltgetriebe 4)	13.0460-4033.2	604033		20034 15,0	ATE
	1.9			01.71	09.74	+ Schaltgetriebe 4)					
	1.6 Limousine		31Z073209	01.75		+ Schaltgetriebe 4)	03.3215-0221.3	020013		Rz 15,87	
	1.6 Limousine		21Z089568	01.75		+ Automatikgetriebe 5)					
	1.7 Limousine		31Z073209	01.70		+ Schaltgetriebe 4)					
	1.7 Limousine		21Z089568	01.70		+ Automatikgetriebe 5)					
	1.9 Coupe		31Z077588	01.70		+ Schaltgetriebe 4)					
	1.9 Coupe		21Z089559	01.71		+ Automatikgetriebe 5)					
	1.9 Coupe			01.70	12.73	+ 6)					
1.9 Limousine		31Z073209	01.71		+ Schaltgetriebe 4)						
1.9 Limousine		21Z089568	01.71		+ Automatikgetriebe 5)						

AUDI 100 (76-79)											
	1.6			08.76	07.79		11.0441-4802.2	250017		Dichtungssatz	ATE
	2.0			06.76	07.78						
	2.2 i			03.77	07.79	+ 6)					
	1.6			08.76	07.79		24.0113-0160.1	413160		256 13,0 11,0 +B	
	2.0			06.76	07.78						
	2.0 D			10.78	07.79	- belüftete Scheiben 6)					
	2.2			04.78	07.79	- belüftete Scheiben 6)					
	2.2	85		03.77	07.79	+ 6)					
	2.0 D			10.78	07.79	+ belüftete Scheiben 7)	24.0122-0118.1	422118		256 22,0 20,0 V +B	
	2.2			08.78	07.79	+ belüftete Scheiben 7)					
	2.2	100		03.77	07.79						
	1.6			08.76	07.79		83.6124-0362.3	330715	2	L=360	
	2.0		43-82300000	06.76							
	2.0 D			10.78	07.79		83.6134-0332.3	330716	2	L=330	
	2.2			03.77	07.79						
	1.6			08.76	07.79		83.7824-0180.3	330812		L=180	
	2.0			06.76	07.79		83.6224-0300.3	330730		L=300	
	2.0 D			10.78	07.79						
	2.2			06.76	07.79						

1) + ABS/ - hydraulic booster / + ABS/ - servofreno idraulico / + ABS/ - amplificateur hydraulique / + ABS/ - servo hidráulico
2) + hydraulic booster / + servofreno idraulico / + amplificateur hydraulique / + servo hidráulico
3) on the brake caliper / sulla pinza freno / sur l'étrier de frein / a la pinza de freno
4) + manual transmission / + scatola cambio velocità / + transmission mécanique / + cambio de velocidad
5) + autom.transmission / + scatola cambio automatico / + transmission automatique / + cambio automático
6) - ventilated discs / - dischi ventilati / - disques ventilés / - disco ventilado
7) + ventilated discs / + dischi ventilati / + disques ventilés / + disco ventilado



									
AUDI 100 (76-79)									
	1.6			08.76	07.79	03.3215-2311.3	020018	+ GG ¹⁾	Rz 15,87
	2.0			06.76	07.78	24.3215-0903.3	020154	+ ALU ²⁾	Rz 15,87
	2.0 D			10.78	07.79	03.3217-2112.3	020027	+ GG ¹⁾	Rz 17,46
	2.2			03.77	07.79	24.3217-0908.3	020167	+ ALU ²⁾	Rz 17,46
	1.6	43-92000001		10.78	07.79	03.0137-0146.2	650146		200 x 40 HEB
	2.0 D	43-92000001		07.79	07.79	03.0137-9041.2	669041		Bremsbacken-Zubehör
	2.2	85 43-92000001		07.79	07.79 + [Ⓢ]				
	2.2	100		03.77	07.79	03.0137-0264.2	650264		230 x 40 HEB
	2.2	100		03.77	07.79	03.0137-9044.2	669044		Bremsbacken-Zubehör
	2.2	100		03.77	07.79	24.0223-0007.1	480037		230/231 x 46
	2.0 D	43-92000001		10.78	07.79	03.0420-0417.3	680417		17,46/200x40 Kit
	2.2	85 43-92000001		07.79	07.79 + [Ⓢ]				
	1.6			08.76	07.79	03.6565-0101.3	320097		BRL 6/5 (4)
	2.0			06.76	07.79				
	2.0 D			10.78	07.79				
	2.2			06.76	07.79				
	2.0 D			10.78	07.79	03.2419-9610.3	030029		Gz 19,05
	2.2			03.77	07.79				
	2.0 D			10.78	07.79	03.2522-4211.3	040017		Nz 22,20
	2.2			03.77	07.79				
AUDI 100 (80-81)									
	1.6		43-B-058000	08.79		11.0441-4802.2	250017		Dichtungssatz
	2.2	100		08.79	07.81	13.0460-2934.2	602934		20669 19,0 /S
	1.6			08.79	07.81	24.0113-0160.1	413160		256 13,0 11,0 +B
	1.9			08.80	07.81				
	2.0 D			08.79	07.81				
	2.2	85		08.79	07.81				
	2.2	100		08.79	07.81	24.0122-0118.1	422118		256 22,0 20,0 V +B
	1.6			08.79	07.81	83.6124-0362.3	330715	2	L=360
	1.9			08.80	07.81	83.6134-0332.3	330716	2	L=330
	2.0 D			08.79	07.81				
	2.2			08.79	07.81				
	1.6			08.79	07.81	83.7824-0180.3	330812	<input type="checkbox"/>	L=180
	1.9			08.80	07.81	83.6224-0300.3	330730	<input type="checkbox"/>	L=300
	2.0 D			08.79	07.81				
	2.2			08.79	07.81				
	1.6			08.79	07.81	03.3215-2311.3	020018	+ GG ¹⁾	Rz 15,87
	1.9			08.80	07.81	24.3215-0903.3	020154	+ ALU ²⁾	Rz 15,87
	2.0 D			08.79	07.81	03.3217-2112.3	020027	+ GG ¹⁾	Rz 17,46
	2.2			08.79	07.81	24.3217-0908.3	020167	+ ALU ²⁾	Rz 17,46
	1.6			08.79	07.81	03.0137-0146.2	650146		200 x 40 HEB
	1.9			08.80	07.81	03.0137-9041.2	669041		Bremsbacken-Zubehör
	2.0 D			08.79	07.81				
	2.2	85		08.79	07.81				
	2.2	100		08.79	07.81	03.0137-0264.2	650264		230 x 40 HEB
	2.2	100		08.79	07.81	03.0137-9164.2	669164		Bremsbacken-Zubehör
	2.2	100		08.79	07.81	24.0223-0007.1	480037		230/231 x 46
	1.9			08.80	07.81	03.0420-0417.3	680417		17,46/200x40 Kit
	2.0 D			08.79	07.81				
	2.2	85		08.79	07.81				
	1.6			08.79	07.81	03.6565-0101.3	320097		BRL 6/5 (4)
	1.9			08.80	07.81				
	2.0 D			08.79	07.81				
	2.2			08.79	07.81				
	2.0 D			08.79	07.81	03.2419-9610.3	030029		Gz 19,05
	2.2			08.79	07.81				
	2.0 D			08.79	07.81	03.2522-4211.3	040017		Nz 22,20
	2.2			08.79	07.81				
AUDI 100 (82)									
	1.9			08.81	07.82	13.0460-2934.2	602934		20669 19,0 /S
	2.0 D			08.81	07.82				
	2.0 TD			11.81	07.82				
	2.2			08.81	07.82				

¹⁾ + cast iron / + ghisa / + fonte grise / + fundición de gris

²⁾ + aluminium / + alluminio / + aluminium / + aluminio

³⁾ - suspension level control / - correttore assetto / - correcteur d'assiette / - regulación altura suspensión

⁴⁾ + ventilated discs / + dischi ventilati / + disques ventilés / + disco ventilado

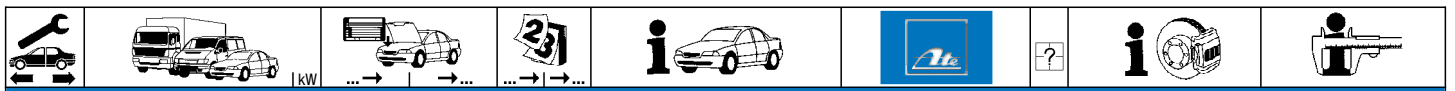

AUDI 100 (82)									
	1.6			08.81	07.82	24.0113-0160.1	413160		256 13,0 11,0 +B
	1.9			08.81	07.82				
	2.0 D			08.81	07.82				
	2.2			08.81	07.82				
	1.9			08.81	07.82	24.0122-0118.1	422118		256 22,0 20,0 V +B
	2.0 D			08.81	07.82				
	2.0 TD			11.81	07.82				
	2.2			08.81	07.82				
	1.6			08.81	07.82	83.6124-0362.3	330715	2	L=360
	1.9			08.81	07.82	83.6134-0332.3	330716	2	L=330
	2.0 D			08.81	07.82				
	2.2			08.81	07.82				
	1.6			08.81	07.82	83.7824-0180.3	330812		L=180
	1.9			08.81	07.82	83.6224-0300.3	330730		L=300
	2.0 D			08.81	07.82				
	2.2			08.81	07.82				
	1.6			08.81	07.82	03.3215-2311.3	020018	+ GG ¹⁾	Rz 15,87
	1.9			08.81	07.82	24.3215-0903.3	020154	+ ALU ²⁾	Rz 15,87
	2.0 D			08.81	07.82	03.3217-2112.3	020027	+ GG ¹⁾	Rz 17,46
	2.2			08.81	07.82	24.3215-0903.3	020154	+ ALU ²⁾	Rz 15,87
	1.6			08.81	07.82	03.0137-0146.2	650146		200 x 40 HEB
	1.9			08.81	07.82	03.0137-9041.2	669041		Bremsbacken-Zubehör
	2.0 D			08.81	07.82				
	2.0 TD			11.81	07.82				
	2.2	85		08.81	07.82				
	2.2			08.81	07.82				
	1.9			08.81	07.82	+ belüftete Scheiben ⁵⁾	03.0137-0264.2	650264	230 x 40 HEB
	2.0 D			08.81	07.82	+ belüftete Scheiben/ +	03.0137-9044.2	669044	Bremsbacken-Zubehör
	2.0 TD			11.81	07.82	+ belüftete Scheiben ⁵⁾			
	2.2	79		08.81	07.82	+			
	2.2	100		08.81	07.82				
	1.9			08.81	07.82	+ belüftete Scheiben ⁵⁾	24.0223-0007.1	480037	230/231 x 46
	2.0 D			08.81	07.82	+ belüftete Scheiben/ +			
	2.2	79		11.81	07.82	+ belüftete Scheiben ⁵⁾			
	2.2	100		08.81	07.82	+			
	1.9			08.81	07.82	- belüftete Scheiben ³⁾	03.0420-0417.3	680417	17,46/200x40 Kit
	2.0 D			08.81	07.82	- belüftete Scheiben/ -			
	2.2	85		11.81	07.82	- belüftete Scheiben ³⁾			
	2.2			08.81	07.82				
	1.6			08.81	07.82	- Niveauregulierung ⁷⁾	03.6565-0101.3	320097	BRL 6/5 (4)
	1.9			08.81	07.82	- Niveauregulierung ⁷⁾			
	2.0 D			08.81	07.82	- Niveauregulierung ⁷⁾			
	2.0 TD			11.81	07.82	- Niveauregulierung ⁷⁾			
	2.2			08.81	07.82	- Niveauregulierung ⁷⁾			
	2.0 D			08.81	07.82		03.2419-9610.3	030029	Gz 19,05
	2.0 TD			11.81	07.82				
	2.2 i			08.81	07.82				
	2.0 D			08.81	07.82		03.2522-4211.3	040017	Nz 22,20
	2.0 TD			11.81	07.82				
	2.2 i			08.81	07.82				

AUDI 100 (83-90)									
	1.8			08.89	12.90	03.7750-0302.4	300071		9"
	2.0			08.89	12.90				
	2.0 TD			08.89	12.90				
	2.4 D			08.89	12.90				
	2.5 TDI			01.90	12.90				
	2.2	100		08.82	12.90	10.0124-3202.3	340011		Hydraulik Verstärker
	2.2 Turbo			08.86	12.90				
	2.3			10.83	12.90				
	1.8			01.88		03.2122-8012.3	010156		THz 22,20
	1.8 Limousine		44-J-300000	08.82	12.87	+ Schaltgetriebe ⁸⁾			
	1.9 Limousine			08.82	07.84	+ Schaltgetriebe ⁸⁾			
	2.0 D Limousine			08.82	12.87				
	2.0 TD Limousine			08.82	12.87	+ Schaltgetriebe ⁸⁾			
	1.8 Avant			08.82	12.87	- verstärktes Fahrwerk ⁹⁾	03.2123-8512.3	010194	THz 23,81
	1.8 Limousine			08.82	12.87	+ Automatikgetriebe ¹⁰⁾			
	1.9 Avant			08.82	07.84	- verstärktes Fahrwerk ⁹⁾			
	1.9 Limousine			08.82	07.84	+ Automatikgetriebe ¹⁰⁾			
	2.0			08.84	12.87				
	2.0 D Avant			08.82	12.87	- verstärktes Fahrwerk ⁹⁾			
2.0 TD Avant			08.82	12.87	- verstärktes Fahrwerk ⁹⁾				
2.0 TD Limousine			08.82	12.87	+ Automatikgetriebe ¹⁰⁾				
	2.2			08.82	09.86				
	2.2	85		08.82	07.84				
	2.2	100		10.83	07.84				
	2.3			10.83	07.84				
	1.8		44-K-300001		12.90	- ABS	03.2122-9612.3	010159	THz 22,20
	2.0			01.88	12.90	- ABS			
	2.0 D			01.88	07.89	- ABS			
	2.0 TD			01.88	12.90	- ABS			

¹⁾ + cast iron / + ghisa / + fonte grise / + fundición de gris
²⁾ + aluminium / + alluminio / + aluminium / + aluminio
³⁾ - ventilated discs / - dischi ventilati / - disques ventilés / - disco ventilado
⁴⁾ - ventilated discs / - / - dischi ventilati / - / - disques ventilés / - / - disco ventilado / -
⁵⁾ + ventilated discs / + dischi ventilati / + disques ventilés / + disco ventilado
⁶⁾ + ventilated discs / + / + dischi ventilati / + / + disques ventilés / + / + disco ventilado / +
⁷⁾ - suspension level control / - correttore assetto / - correcteur d'assiette / - regulación altura suspensión
⁸⁾ + manual transmission / + scatola cambio velocità / + transmission mécanique / + cambio de velocidad
⁹⁾ - reinforced suspension / - sospensione rinforzata / - châssis renforcé / - suspensión reforzada
¹⁰⁾ + autom.transmission / + scatola cambio automatico / + transmission automatique / + cambio automático



AUDI 100 (83-90)											
	2.4 D			08.89	12.90	- ABS	03.2122-9612.3	010159		THz 22,20	ATE
	2.5 TDI			01.90	12.90	- ABS					
	1.8			08.89	12.90	+ ABS	24.2122-1601.3	010380		THz 22,20	LUC
	2.0			08.89	12.90	+ ABS					
	2.0 TD			08.89	12.90	+ ABS					
	2.4 D			08.89	12.90	+ ABS					
	2.5 TDI			01.90	12.90	+ ABS					
	1.8 Avant			08.82	12.90	+ verstärktes Fahrwerk ¹⁾	03.2123-0566.3	010169		THz 23,81	ATE
	1.9 Avant			08.82	12.90	+ verstärktes Fahrwerk ¹⁾					
	2.0 D Avant			08.82	12.90	+ verstärktes Fahrwerk ¹⁾					
2.0 TD Avant			08.82	12.90	+ verstärktes Fahrwerk ¹⁾						
2.2	100		08.84	12.90							
2.2 Turbo Limousine			08.86	12.90							
2.3			08.84	12.90							
2.2 Turbo Avant			08.86	12.90		03.2125-3210.3	010212		THz 25,40	ATE	
	1.8 Limousine		44-H-073660	08.82			24.3541-1609.5	240039		D=54, - Halter	LUC
	1.9 Limousine			08.82	07.84		24.3541-1610.5	240040		D=54, - Halter	LUC
	2.0 D Limousine			08.82	07.84		11.0441-5405.2	250030		Dichtungssatz	ATE
	2.0 TD Limousine			08.82	07.84		11.0101-5409.2	260035		Hülzensatz	ATE
							11.8171-0008.1	990049		Führungsbolzen	ATE
							24.0101-4301.2	260047		Bremssattel-Zubehör	LUC
							11.0101-5403.2	260010		Faltenbalsatz	LUC
	1.8 Limousine		44-H-073661		12.90		24.3541-1609.5	240039		D=54, - Halter	LUC
							24.3541-1610.5	240040		D=54, - Halter	LUC
							11.0441-5405.2	250030		Dichtungssatz	ATE
1.8 Avant		44-H-073660	08.82			24.3541-1719.5	240057		D=54, - Halter	LUC	
1.9 Avant			08.82	07.84		24.3541-1720.5	240058		D=54, - Halter	LUC	
2.0		44-H-073660	08.84			11.0441-5405.2	250030		Dichtungssatz	ATE	
2.0 D		44-H-073660	08.84			11.0101-5409.2	260035		Hülzensatz	ATE	
2.0 D Avant			08.82	07.84		11.8171-0008.1	990049		Führungsbolzen	ATE	
2.0 TD		44-H-073660	08.84			24.0101-4301.2	260047		Bremssattel-Zubehör	LUC	
2.0 TD Avant			08.82	07.84		11.0101-5403.2	260010		Faltenbalsatz	LUC	
2.2	85	44-H-073660	08.82								
2.2	100	44-H-073660	08.82								
2.3		44-H-073660	10.83								
1.8 Avant		44-H-073661		12.90		11.3541-8521.2	220113		D=54, - Halter	ATE	
2.0		44-H-073661		12.90		24.3541-1719.5	240057		D=54, - Halter	LUC	
2.0 D		44-H-073661		07.89		24.3541-1720.5	240058		D=54, - Halter	LUC	
2.0 TD		44-H-073661		12.90		11.0441-5405.2	250030		Dichtungssatz	ATE	
2.2	85	44-H-073661		09.86		11.0101-5409.2	260035		Hülzensatz	ATE	
2.2	100	44-H-073661		12.90	für 4-Loch-Felge ²⁾	24.0101-4301.2	260047		Bremssattel-Zubehör	LUC	
2.3		44-H-073661		12.90	für 4-Loch-Felge ²⁾	11.0101-5403.2	260010		Faltenbalsatz	LUC	
2.4 D			08.89	12.90							
2.2 CS	100	44-G-073363	08.84			24.3541-1719.5	240057		D=54, - Halter	LUC	
2.3 CS		44-G-073363	10.83			24.3541-1720.5	240058		D=54, - Halter	LUC	
						24.0101-4301.2	260047		Bremssattel-Zubehör	LUC	
						11.0101-5403.2	260010		Faltenbalsatz	LUC	
	1.8			08.82	12.90		13.0460-2925.2	602925		20901 19,0 +WK/S	LUC
	1.9			08.82	07.84						
	2.0			08.84	12.90						
	2.0 D			08.82	07.89						
	2.0 TD			08.82	12.90						
	2.2	85		08.82	09.86						
	2.2	100		08.82	12.90	für 4-Loch-Felge ²⁾					
	2.2 CS	100	44-G-073363	08.82							
	2.3			10.83	12.90	für 4-Loch-Felge ²⁾					
	2.4 D			08.89	12.90						
2.2	100		08.82	12.90	für 5-Loch-Felge ³⁾	13.0460-2963.2	602963		21138 18,8 +WK/S	LUC	
2.2 CS	100	44-G-073364	44-K-045093								
2.2 Turbo			44-K-045093	08.86							
2.3			10.83	12.90	für 5-Loch-Felge ³⁾						
2.3 CS			44-K-045093	10.83							
2.2 CS	100	44-K-045094		12.90		13.0460-5403.2	605403		21211 18,7 +WE	ATE	
2.2 Turbo		44-K-045094		12.90		13.0460-2963.2	602963		21138 18,8 +WK/S	LUC	
2.3 CS		44-K-045094		12.90							
2.5 TDI			01.90	12.90							
	1.8 Limousine			08.82	12.90		24.0113-0160.1	413160		256 13,0 11,0 +B	
	1.9 Limousine			08.82	07.84						
	2.0 D Limousine			08.82	07.84						
	2.0 TD Limousine			08.82	07.84						
	1.8 Avant			08.82	12.90		24.0122-0118.1	422118		256 22,0 20,0 V +B	
	1.9 Avant			08.82	07.84						
	2.0			08.84	12.90						
	2.0 D			08.84	07.89						
	2.0 D Avant			08.82	07.84						
	2.0 TD			08.84	12.90						
2.0 TD Avant			08.82	07.84							
2.2	85		08.82	09.86							
2.2	100		08.82	12.90	für 4-Loch-Felge ²⁾						
2.3			10.83	12.90	für 4-Loch-Felge ²⁾						
2.4 D			08.89	12.90							
2.2 CS	100	44-G-073363	08.82			24.0122-0120.1	422120		280 22,0 20,0 V L		
2.3 CS		44-G-073363	10.83								

¹⁾ + reinforced suspension / + sospensione rinforzata / + châssis renforcé / + suspensión reforzada

²⁾ for 4 bore wheel rim / per cerchione a 4 fori / pour jante à 4 trous / para Llantas de 4 taladros

³⁾ for 5 bore wheel rim / per cerchione a 5 fori / pour jante à 5 trous / para Llantas de 5 taladros

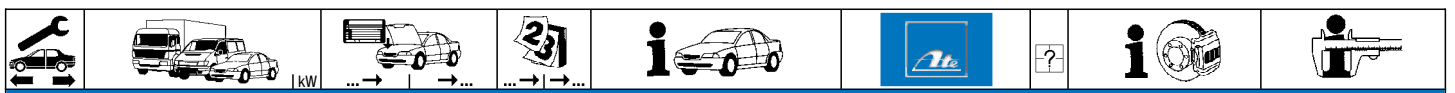

AUDI 100 (83-90)

	2.2 2.2 CS 2.2 Turbo 2.3 2.3 CS 2.5 TDI	100 100 44-G-073364 44-G-073364	08.82 12.90 08.86 10.83 12.90 01.90	12.90 für 5-Loch-Felge ¹⁾ 12.90 12.90 12.90 für 5-Loch-Felge ¹⁾ 12.90	24.0125-0102.1	425102		276 25,0 23,0 V L	
	1.8 1.9 2.0 2.0 D 2.0 TD 2.2 2.2 2.2 CS 2.3 2.3 CS	44-G-200000 44-G-200000 44-G-200000 44-G-200000 44-G-200000 85 100 100	08.82 08.82 08.84 08.82 08.82 08.82 08.82 10.83 10.83	07.84	83.6224-0300.3	330730	2	L=300	
	2.2 CS 2.3 CS	100 44-G-000001 44-G-000001	08.82 08.82		83.6134-0332.3	330716	2	L=330	
	1.8 2.0 2.0 D 2.0 TD 2.2 2.2 2.2 Turbo 2.3 2.4 D 2.5 TDI	44-G-200001 44-G-200001 44-G-200001 44-G-200001 85 44-G-200001 100 44-G-200001 44-G-200001	12.90 12.90 07.89 12.90 09.86 12.90 08.86 12.90 08.89 01.90	- verstärktes Fahrwerk ²⁾ - verstärktes Fahrwerk ²⁾ - verstärktes Fahrwerk ²⁾ - verstärktes Fahrwerk ²⁾ - verstärktes Fahrwerk ²⁾ - verstärktes Fahrwerk ²⁾ - verstärktes Fahrwerk ²⁾ - verstärktes Fahrwerk ²⁾ - verstärktes Fahrwerk ²⁾	24.5170-0315.3	331309	2	L=315	
	1.8 2.0 2.0 D 2.0 TD 2.2 2.2 2.2 Turbo 2.3 2.4 D 2.5 TDI	44-G-200001 44-G-200001 44-G-200001 44-G-200001 85 44-G-200001 100 44-G-200001 44-G-200001	12.90 12.90 07.89 12.90 09.86 12.90 08.86 12.90 08.89 01.90	+ verstärktes Fahrwerk ³⁾ + verstärktes Fahrwerk ³⁾ + verstärktes Fahrwerk ³⁾ + verstärktes Fahrwerk ³⁾ + verstärktes Fahrwerk ³⁾ + verstärktes Fahrwerk ³⁾ + verstärktes Fahrwerk ³⁾ + verstärktes Fahrwerk ³⁾ + verstärktes Fahrwerk ³⁾	24.5113-0380.3	331344	2	L=382	
	1.8 1.9 2.0 2.0 D 2.0 TD 2.2 2.2 2.2 Turbo 2.3	44-E-000001 44-E-000001 44-E-000001 44-E-000001 85 44-E-000001 100 44-E-000001	44-J-039012 44-J-039012 44-J-039012 44-J-039012 44-J-039012 44-J-039012 44-J-039012 44-J-039012	08.84 08.86 10.83	+ ABS + ABS + ABS + ABS + ABS	24.0101-3601.2	260044		Bremssattel-Zubehör LUC
	2.2 CS 2.3 CS	100	08.82 10.83	12.87 12.87	24.3434-1701.5 24.3434-1702.5 11.0101-5403.2	240357 240358 260010	<input type="checkbox"/> <input type="checkbox"/>	D=43, - Halter LUC D=43, - Halter LUC Fallenbalgsatz LUC	
	1.8 2.0 2.0 D 2.0 TD 2.2 2.2 2.2 Turbo 2.3 2.3 2.4 D 2.5 TDI	44-J-039013 44-J-039013 44-J-039013 44-J-039013 100 44-J-039013 100 44-J-039013 44-J-039013	08.82 08.82 08.84 08.82 08.82 01.88 01.88 08.89 01.90	12.90 + ABS 12.90 + ABS 07.89 + ABS 12.90 + ABS 12.87 12.90 12.90 12.87 12.90 12.90 + ABS	24.3384-1601.5 24.3384-1602.5 24.0101-3601.2	240013 240014 260044	<input type="checkbox"/> <input type="checkbox"/>	D=38, - Halter LUC D=38, - Halter LUC Bremssattel-Zubehör LUC	
	1.8 1.9 2.0 2.0 D 2.0 TD 2.2 2.2 2.2 Turbo 2.3 2.4 D 2.5 TDI	85 100	08.82 08.82 08.84 08.82 08.82 08.82 08.86 10.83 08.89 01.90	12.90 + ABS 07.84 + ABS 12.90 + ABS 07.89 + ABS 12.90 + ABS 09.86 + ABS 12.90 12.90 12.90 + ABS	13.0460-3602.2	603602		21144 15,8 / S LUC	
	1.8 1.9 2.0 2.0 D 2.0 TD 2.2 2.2 2.2 Turbo 2.3	85 100	08.82 08.82 08.84 08.82 08.82 08.82 08.82 10.83	12.87 + ABS 07.84 + ABS 12.87 + ABS 12.87 + ABS 12.87 + ABS 09.86 + ABS 12.87 12.87	24.0110-0178.1	410178		245 10,0 8,0 +B	
	2.2 CS 2.2 Turbo 2.3 CS	100	08.82 08.86 10.83	12.87 12.87 12.87	24.0110-0154.1	410154		245 10,0 8,0	
	1.8 2.0 2.0 D		01.88 01.88 01.88	12.90 + ABS 12.90 + ABS 07.89 + ABS	24.0110-0200.1	410200		245 10,0 8,0	

¹⁾ for 5 bore wheel rim / per cerchione a 5 fori / pour jante à 5 trous / para Llantas de 5 taladros
²⁾ - reinforced suspension / - sospensione rinforzata / - châssis renforcé / - suspensión reforzada
³⁾ + reinforced suspension / + sospensione rinforzata / + châssis renforcé / + suspensión reforzada



AUDI 100 (83-90)													
	2.0 TD	100	01.88	12.90 + ABS	24.0110-0200.1	410200							245 10,0 8,0
	2.2		01.88	12.90 + 14" Rad ¹⁾									
	2.3	100	01.88	12.90 + 14" Rad ¹⁾	24.0110-0154.1	410154							245 10,0 8,0
	2.4 D		08.89	12.90 + ABS									
	2.5 TDI	100	01.90	12.90 + 14" Rad ¹⁾	24.0110-0154.1	410154							245 10,0 8,0
	2.2 CS		01.88	12.90 + 15" Rad ²⁾									
	2.2 Turbo	100	01.88	12.90 + 15" Rad ²⁾	24.0110-0154.1	410154							245 10,0 8,0
	2.3		10.83	12.90 + 15" Rad ²⁾									
	2.3 CS	100	01.88	12.90 + 15" Rad ²⁾	24.0110-0154.1	410154							245 10,0 8,0
	2.5 TDI		01.90	12.90 + 15" Rad ²⁾									
	1.8	85	08.82	07.84 + HA-Trommelbremse ³⁾	83.6204-0240.3	330718	2						L=240
	1.9		08.82	07.84 + HA-Trommelbremse ³⁾									
	2.0 D	85	08.82	07.84 + HA-Trommelbremse ³⁾	83.6204-0240.3	330718	2						L=240
	2.0 TD		08.82	07.84 + HA-Trommelbremse ³⁾									
	2.2	85	08.82	07.84 + HA-Trommelbremse ³⁾	83.7824-0180.3	330812	2						L=180
	1.8		08.84	+ HA-Trommelbremse ³⁾									
	2.0	85	08.84	+ HA-Trommelbremse ³⁾	83.7824-0180.3	330812	2						L=180
	2.0 D		08.82	+ HA-Trommelbremse ³⁾									
	2.0 TD	85	08.82	+ HA-Trommelbremse ³⁾	83.7824-0180.3	330812	2						L=180
	2.2		08.84	+ HA-Trommelbremse ³⁾									
	1.8	85	07.89	+ HA-Trommelbremse ³⁾	83.6204-0240.3	330718	2						L=240
	2.0		07.89	+ HA-Trommelbremse ³⁾									
	2.0 D	85	07.89	+ HA-Trommelbremse ³⁾	83.6204-0240.3	330718	2						L=240
	2.0 TD		07.89	+ HA-Trommelbremse ³⁾									
	2.2	85	09.86	+ HA-Trommelbremse ³⁾	83.6204-0240.3	330718	2						L=240
	1.8		08.89	+ HA-Trommelbremse ³⁾									
	2.0	100	08.89	+ HA-Trommelbremse ³⁾	83.7824-0180.3	330812	2						L=180
	2.0 TD		08.89	+ HA-Trommelbremse ³⁾									
	2.4 D	100	08.89	+ HA-Trommelbremse ³⁾	83.7824-0180.3	330812	2						L=180
	1.8		08.82	+ HA-Trommelbremse ³⁾									
	1.9	85	08.82	+ HA-Trommelbremse ³⁾	83.6204-0240.3	330718	2						L=240
	2.0		08.82	+ HA-Trommelbremse ³⁾									
	2.0 D	100	08.82	+ HA-Trommelbremse ³⁾	83.6301-0150.3	330342							L=150
	2.0 TD		08.82	+ HA-Trommelbremse ³⁾									
	2.2	85	08.82	+ HA-Trommelbremse ³⁾	83.6134-0332.3	330716							L=330
	2.2		08.82	+ HA-Trommelbremse ³⁾									
	2.3	100	10.83	+ HA-Trommelbremse ³⁾	83.6204-0240.3	330718	2						L=240
	1.8		01.86	+ HA-Scheibenbremse ⁴⁾									
	2.0	85	01.86	+ HA-Scheibenbremse ⁴⁾	83.6204-0240.3	330718	2						L=240
	2.0 D		01.86	+ HA-Scheibenbremse ⁴⁾									
	2.0 TD	100	01.86	+ HA-Scheibenbremse ⁴⁾	24.5113-0220.3	331318	2						L=220
	2.2		01.86	+ HA-Scheibenbremse ⁴⁾									
	2.2 Turbo	85	01.86	+ HA-Scheibenbremse ⁴⁾	83.6204-0240.3	330718	2						L=240
	2.3		01.86	+ HA-Scheibenbremse ⁴⁾									
	2.5 TDI	100	01.90	+ HA-Scheibenbremse ⁴⁾	83.7824-0180.3	330812	2						L=180
	1.8		08.89	+ HA-Scheibenbremse ⁴⁾									
	2.0	100	08.89	+ HA-Scheibenbremse ⁴⁾	24.5113-0220.3	331318	2						L=220
	2.0 TD		08.89	+ HA-Scheibenbremse ⁴⁾									
	2.2	100	08.89	+ HA-Scheibenbremse ⁴⁾	83.7824-0180.3	330812	2						L=180
	2.2 Turbo		08.89	+ HA-Scheibenbremse ⁴⁾									
	2.3	100	08.89	+ HA-Scheibenbremse ⁴⁾	83.7824-0180.3	330812	2						L=180
	2.4 D		08.89	+ HA-Scheibenbremse ⁴⁾									
	2.5 TDI	100	01.90	+ HA-Scheibenbremse ⁴⁾	24.5113-0220.3	331318	2						L=220
	1.8		08.89	+ HA-Scheibenbremse ⁴⁾									
	1.8	85	08.82	- ABS	03.3217-2112.3	020027							Rz 17,46
	1.9		08.82	- ABS									
	2.0	85	08.84	- ABS	03.3217-2112.3	020027							Rz 17,46
	2.0 D		08.82	- ABS									
	2.0 TD	85	08.82	- ABS	03.3217-2112.3	020027							Rz 17,46
	2.2		08.82	- ABS									
	2.4 D	85	08.89	- ABS	03.3217-2112.3	020027							Rz 17,46
	2.2		08.82	- ABS									
	1.8	85	08.82	- ABS	03.3217-2112.3	020027							Rz 17,46
	1.9		08.82	- ABS									
	2.0	85	08.84	- ABS	03.3217-2112.3	020027							Rz 17,46
	2.0 D		08.82	- ABS									
	2.0 TD	85	08.82	- ABS	03.3217-2112.3	020027							Rz 17,46
	2.2		08.82	- ABS									
	2.2	85	08.82	- ABS	03.3217-2112.3	020027							Rz 17,46
	2.4 D		08.89	- ABS									
	1.8	85	08.82	- ABS	24.0223-0007.1	480037							230/231 x 46
	1.9		08.82	- ABS									
	2.0	85	08.84	- ABS	24.0223-0007.1	480037							230/231 x 46
	2.0 D		08.82	- ABS									
	2.0 TD	85	08.82	- ABS	24.0223-0007.1	480037							230/231 x 46
	2.2		08.82	- ABS									
	2.2	85	08.82	- ABS	24.0223-0007.1	480037							230/231 x 46
	2.4 D		08.89	- ABS									
	1.8	85	01.88	- ABS	24.0223-0011.1	480041							230/231 x 46
	2.0		01.88	- ABS									
	2.0 D	85	01.88	- ABS	24.0223-0011.1	480041							230/231 x 46
	2.0 TD		01.88	- ABS									
	2.4 D	85	08.89	- ABS	03.0420-1217.3	681217							17,46/230x40 Kit
	1.8		08.82	- ABS									
	1.9	85	08.82	- ABS	03.0420-1217.3	681217							17,46/230x40 Kit
	2.0		01.88	- ABS									
	2.0 D	85	01.88	- ABS	03.0420-1217.3	681217							17,46/230x40 Kit
	2.0 TD		01.88	- ABS									
	2.2	85	03.88	- ABS	03.0420-1217.3	681217							17,46/230x40 Kit
	2.4 D		08.89	- ABS									











¹⁾ + 14" wheel / + ruota 14" / + roue 14" / + rueda 14"

²⁾ + 15" wheel / + ruota 15" / + roue 15" / + rueda 15"

³⁾ + RA drum brake / + P freno a tamburo / + frein à tambour essieu AR / + ET-tambores de freno

⁴⁾ + RA disc brake / + P disco freno / + frein à disque essieu AR / + ET-disco de freno















⁵⁾ on the brake caliper / sulla pinza freno / sur l'étrier de frein / a la pinza de freno

AUDI 100 (83-90)											
	1.8			08.82	12.90	24.3727-0119.2	580119	2	+ HA-Trommelbremse ¹⁾	L=1395	
	1.9			08.82	07.84						
	2.0			08.84	12.90						
	2.0 D			08.82	07.89						
	2.0 TD			08.82	12.90						
	2.2	85		08.82	09.86						
	2.4 D			08.89	12.90						
	1.8			08.82	12.87	24.3727-0138.2	580138	2	+ HA-Scheibenbremse ²⁾	L=1438	
	1.9			08.82	07.84						
	2.0			08.84	12.87						
	2.0 D			08.82	12.87						
	2.0 TD			08.82	12.87						
2.2	85		08.82	09.86							
2.2	100		08.82	12.87							
2.2 Turbo			08.86	12.87							
2.3			10.83	12.87							
1.8			01.88	12.90	24.3727-0130.2	580130	2	+ HA-Scheibenbremse ²⁾	L=1455		
2.0			01.88	12.90							
2.0 D			01.88	07.89							
2.0 TD			01.88	12.90							
2.2	100		01.88	12.90							
2.2 Turbo			01.88	12.90							
2.3			01.88	12.90							
2.4 D			08.89	12.90							
2.5 TDI			01.90	12.90							
	1.8			08.82	12.90	03.6585-0108.3	320115			BRL 8/5 (4) ATE	
	1.9			08.82	07.84						
	2.0			08.84	12.90						
	2.0 D			08.82	07.89						
	2.0 TD			08.82	12.90						
	2.2	85		08.82	09.86						
	2.2	100		08.82	12.90						
	2.2 Turbo			08.86	12.90						
	2.3			10.83	12.90						
	2.4 D			08.89	12.90						
	2.5 TDI			01.90	12.90						
		1.8			01.88	12.90	03.2419-9610.3	030029			Gz 19,05
2.0				08.84	12.90						
2.0 D				08.82	07.89						
2.0 TD				08.82	12.90						
2.2		100		08.82	12.90						
2.2 Turbo				08.86	12.90						
2.3				10.83	12.90						
2.4 D				08.89	12.90						
2.5 TDI				01.90	12.90						
		2.0			08.84	12.87	03.2522-4211.3	040017			Nz 22,20
		2.0 D			08.82	12.87					
		2.0 TD			08.82	12.87					
	2.2	100		08.82	12.87						
	2.2 Turbo			08.86	12.87						
	2.3			10.83	12.87						
	1.8			01.88	12.90	03.2522-4300.3	040085			Nz 22,20	
	2.0			01.88	12.90						
	2.0 D			01.88	07.89						
	2.0 TD			01.88	12.90						
	2.2	100		01.88	12.90						
	2.2 Turbo			01.88	12.90						
2.3			01.88	12.90							
2.4 D			08.89	12.90							
2.5 TDI			01.90	12.90							
	1.8			08.82	12.87	24.3728-0115.2	590115			L=1264	
AUDI 100 (91-94)											
	1.6			03.92	07.93	03.2123-0491.3	010167		- ABS	Thz 23,81 ATE	
	2.0			12.90	07.94	24.2123-1602.3	010384		+ ABS	Thz 23,81 LUC	
	2.0 16V			01.92	07.94						
	2.3			12.90	07.94						
	2.4 D			05.91	07.94						
	2.5 TDI			06.91	07.94						
	2.6			04.92	07.94						
	2.8			12.90	07.94						
	1.6			03.92	07.93	11.3571-8506.2	220126			D=57, - Halter ATE	
	2.0			12.90	07.94	24.3571-8505.5	240489			D=57, - Halter ATE	
	2.0 16V			01.92	07.94	24.3571-8506.5	240490			D=57, - Halter ATE	
	2.3			12.90	07.94	11.0441-5704.2	250034			Dichtungssatz ATE	
	2.4 D			05.91	07.94	11.0101-5409.2	260035			Hülensatz ATE	
	2.5 TDI			06.91	07.94	11.8171-0008.1	990049			Führungsbolzen ATE	
						11.8116-0143.1	390513	2		Haltefeder ATE	









¹⁾ + RA drum brake / + P freno a tamburo / + frein à tambour essieu AR / + ET-tambores de freno

²⁾ + RA disc brake / + P disco freno / + frein à disque essieu AR / + ET-disco de freno

³⁾ - suspension level control / - correttore assetto / - correcteur d'assiette / - regulación altura suspensión



























AUDI 100 (91-94)													
	2.6 2.8			04.92 12.90	07.94 07.94			11.3571-8508.2 24.3571-8507.5 24.3571-8508.5 11.0441-5704.2 11.8170-0306.1 11.0101-5409.2 11.8171-0008.1 11.8116-0143.1	220128 240555 240556 250034 260102 260035 990049 390513	2 2	D=57, - Halter D=57, - Halter D=57, - Halter Dichtungssatz Halter Hülzensatz Führungsbolzen Haltefeder	ATE ATE ATE ATE ATE ATE ATE ATE	
	1.6 2.0 2.0 16V 2.3 2.4 D 2.5 TDI 2.6 2.8			03.92 12.90 01.92 12.90 05.91 06.91 04.92 12.90	07.93 07.94 07.94 07.94 07.94 07.94 07.94 07.94			13.0460-7050.2	607050		20678 19,5 +WK	ATE	
	1.6 2.0 2.0 16V 2.3 2.4 D 2.5 TDI			03.92 12.90 01.92 12.90 05.91 06.91	07.93 07.94 07.94 07.94 07.94 07.94			24.0115-0105.1 24.0315-0105.1	415105 515105		288 15,0 13,0 L +B 288 15,0 13,0 L +B PD		
	2.6 2.8			04.92 12.90	07.94 07.94			24.0125-0105.1 24.0325-0105.1	425105 525105		288 25,0 23,0 V L +B 288 25,0 23,0 V L +B PD		
	1.6 2.0 2.0 16V 2.3 2.4 D 2.5 TDI 2.6 2.8			03.92 12.90 01.92 12.90 05.91 06.91 04.92 12.90	07.93 07.94 07.94 07.94 07.94 07.94 07.94 07.94			83.7813-0270.3	330797	2	L=270		
	1.6 2.0 2.0 16V 2.3 2.4 D 2.5 TDI 2.6 2.8		4A-P-078948 4A-P-078948 4A-P-078948 4A-P-078948 4A-P-078948 4A-P-078948 4A-P-078948 4A-P-078948	03.92 12.90 01.92 12.90 05.91 06.91 04.92 12.90	+ ABS + ABS + ABS			24.3384-1601.5 24.3384-1602.5 24.0101-3601.2	240013 240014 260044	 	D=38, - Halter D=38, - Halter Bremsattel-Zubehör	LUC LUC LUC	
	1.6 2.0 2.0 2.0 16V 2.3 2.4 D 2.4 D 2.5 TDI 2.6 2.8	4A-P-078949 4A-P-078949 4A-P-078949 4A-P-078949 4A-P-078949 4A-P-078949 4A-P-078949		07.93 06.93 07.94 07.94 07.94 06.93 07.94 07.94 07.94	+ ABS + ABS + ABS			24.3384-1709.5 24.3384-1710.5	240257 240258	 	D=38, - Halter D=38, - Halter	LUC LUC	
	1.6 2.0 2.0 2.0 16V 2.3 2.4 D 2.4 D 2.5 TDI 2.6 2.8			03.92 12.90 07.93 01.92 12.90 05.91 07.93 06.91 04.92 12.90	+ ABS + ABS + ABS			13.0460-3602.2	603602		21144 15,8 /S	LUC	
	1.6 2.0 2.0 2.0 16V 2.3 2.4 D 2.4 D 2.5 TDI 2.6 2.8			03.92 12.90 07.93 01.92 12.90 05.91 07.93 06.91 04.92 12.90	+ ABS + ABS + ABS			24.0110-0201.1 24.0310-0201.1	410201 510201		245 10,0 8,0 +B 245 10,0 8,0 +B PD		
	1.6 2.0 2.0 2.4 D	74 85		03.92 12.90 12.90 05.91	07.93 06.93 06.93 06.93	- ABS - ABS - ABS - ABS		83.7824-0180.3	330812	2	L=180		
	1.6 2.0 2.0 2.0 2.0 2.0 2.0 16V 2.3 2.4 D 2.4 D 2.5 TDI 2.6 2.8	74 74 85 85		03.92 12.90 07.93 12.90 07.93 01.92 12.90 05.91 07.93 06.91 04.92 12.90	+ ABS + ABS + ABS			83.7824-0180.3 24.5113-0220.3	330812 331318	2 2	am Bremsattel ¹⁾	L=180 L=220	

¹⁾ on the brake caliper / sulla pinza freno / sur l'étrier de frein / a la pinza de freno

AUDI 100 (91-94)										
	1.6 2.0 2.0 2.4 D	74 85		03.92 12.90 12.90 05.91	07.93 07.93 07.93 07.93	- ABS - ABS - ABS - ABS	24.3220-0909.3	020210		Rz 20,64
	1.6 2.0 2.0 2.4 D	74 85		03.92 12.90 12.90 05.91	07.93 07.93 07.93 07.93	- ABS - ABS - ABS - ABS	03.0137-0264.2 03.0137-9164.2	650264 669164		230 x 40 HEB Bremsbacken-Zubehör VW
	1.6 2.0 2.0 2.4 D	74 85		03.92 12.90 12.90 05.91	07.93 06.93 06.93 06.93	- ABS - ABS - ABS - ABS	24.0223-0014.1	480065		230/231 x 51
	1.6 2.0 2.0 2.4 D	74 85		03.92 12.90 12.90 05.91	07.93 07.93 07.93 07.93	- ABS - ABS - ABS - ABS	03.0520-6120.3	696120		20,64/230x40 TopKit VW
	1.6 2.0 2.0 2.4 D	74 85		03.92 12.90 12.90 05.91	07.93 07.93 07.93 07.93	- ABS - ABS - ABS - ABS	24.3727-0141.2	580141	2 ↓	L=1420
	1.6 2.0 2.0 2.0 16V 2.3 2.4 D 2.5 TDI 2.6 2.8	74 85	4A-P-078948 4A-P-078948 4A-P-078948 4A-P-078948 4A-P-078948 4A-P-078948 4A-P-078948 4A-P-078948	03.92 12.90 12.90 01.92 12.90 05.91 06.91 04.92 12.90		+ ABS + ABS + ABS + ABS	24.3727-0142.2	580142	2 ↓	L=1476
	1.6 2.0 2.0 2.0 2.0 16V 2.3 2.4 D 2.4 D 2.5 TDI 2.6 2.8	74 74 85 85	4A-P-078949 4A-P-078949 4A-P-078949 4A-P-078949	07.93 07.93 07.93 07.93		+ ABS + ABS + ABS + ABS	24.3727-0154.2	580154	2 ↓	L=1491
	1.6 2.0 2.0 16V 2.3 2.4 D 2.5 TDI 2.6 2.8			03.92 12.90 01.92 12.90 05.91 06.91 04.92 12.90	07.93 07.94 07.94 07.94 07.94 07.94 07.94 07.94	- Niveauregulierung ¹⁾ - Niveauregulierung ¹⁾ - Niveauregulierung ¹⁾ - Niveauregulierung ¹⁾ - Niveauregulierung ¹⁾ - Niveauregulierung ¹⁾	03.6585-0108.3	320115		BRL 8/5 (4) ATE
	1.6 2.0 2.0 16V 2.3 2.3 2.4 D 2.4 D 2.5 TDI 2.5 TDI 2.6 2.6 2.8 2.8			03.92 12.90 12.90 01.92 01.92 12.90 12.90 05.91 05.91 06.91 06.91 04.92 04.92 12.90 12.90	09.92 09.92 07.94 09.92 07.94 09.92 07.94 09.92 07.94 09.92 07.94 09.92 07.94 09.92 07.94		03.2419-9610.3	030029		Gz 19,05
	1.6 2.0 2.0 16V 2.3 2.4 D 2.5 TDI 2.6 2.8			10.92 10.92 10.92 10.92 10.92 10.92 10.92	07.93 07.94 07.94 07.94 07.94 07.94 07.94		24.2419-1731.3	030121		Gz 19,05
	1.6 2.0 2.0 16V 2.3 2.4 D 2.5 TDI 2.6 2.8			03.92 12.90 01.92 12.90 05.91 06.91 04.92 12.90	07.93 07.94 07.94 07.94 07.94 07.94 07.94 07.94		03.2522-4300.3	040085		Nz 22,20

¹⁾ - suspension level control / - correttore assetto / - correcteur d'assiette / - regulación altura suspensión



AUDI 100 Quattro (85-90)											
	2.2 2.2 Turbo 2.3			08.85 03.86 08.86	11.90 11.90 11.90	+ Hydraulikverstärker 1) + Hydraulikverstärker 1) + Hydraulikverstärker 1)	10.0124-3202.3	340011		Hydraulik Verstärker	
	1.8 Limousine 2.2 Limousine 2.2 Turbo Limousine 2.3 Limousine			10.84 08.85 03.86 08.86	11.90 11.90 11.90 11.90	- Hydraulikverstärker 2) + Hydraulikverstärker 1) + Hydraulikverstärker 1) + Hydraulikverstärker 1)	03.2122-8012.3	010156		THz 22,20 THz 23,81 THz 23,81	ATE ATE ATE
	2.2 Avant 2.2 Turbo Avant 2.3 Avant		44-J-300000 44-J-300000 44-J-300000	08.85 03.86 08.86		+ Hydraulikverstärker 1) + Hydraulikverstärker 1) + Hydraulikverstärker 1)	03.2125-2510.3	010209		THz 25,40	ATE
	2.2 Avant 2.2 Turbo Avant 2.3 Avant	44-K-000001 44-K-000001 44-K-000001			11.90 11.90 11.90	+ Hydraulikverstärker 1) + Hydraulikverstärker 1) + Hydraulikverstärker 1)	03.2125-3210.3	010212		THz 25,40	ATE
	1.8 2.2 2.3		44-G-073362 44-G-073362	10.84 08.85 08.86	12.87		24.3541-1719.5 24.3541-1720.5 24.0101-4301.2 11.0101-5403.2	240057 240058 260047 260010		D=54, - Halter D=54, - Halter Bremsattel-Zubehör Fallenbalsatz	LUC LUC LUC LUC
	1.8 2.2 2.3			01.88 01.88 01.88	11.90 11.90 11.90	- verstärktes Fahrwerk 5) - verstärktes Fahrwerk 5) - verstärktes Fahrwerk 5)	24.3541-1719.5 24.3541-1720.5 24.0101-4301.2 11.0101-5403.2	240057 240058 260047 260010		D=54, - Halter D=54, - Halter Bremsattel-Zubehör Fallenbalsatz	LUC LUC LUC LUC
	1.8 2.2 2.3		44-G-073362 44-G-073362	10.84 08.85 08.86	12.87		13.0460-2925.2	602925		20901 19,0 +WK/S	LUC
	2.2 2.2 Turbo 2.3	44-G-073363 44-G-073363			12.87 12.87 12.87		13.0460-2963.2	602963		21138 18,8 +WK/S	LUC
	1.8 2.2 2.3			01.88 01.88 01.88	11.90 11.90 11.90		13.0460-2925.2	602925		20901 19,0 +WK/S	LUC
	2.2 Turbo 2.2 Turbo	44-K-045093 44-K-045094		01.88 11.90			13.0460-2963.2 13.0460-5403.2 13.0460-2963.2	602963 605403 602963		21138 18,8 +WK/S 21211 18,7 +WE 21138 18,8 +WK/S	LUC ATE LUC
	1.8 2.2 2.3		44-G-073362 44-G-073362	10.84 08.85 08.86	12.87		24.0122-0118.1 24.0122-0120.1	422118 422120		256 22,0 20,0 V +B 280 22,0 20,0 V L	
	2.2 2.2 Turbo 2.3	44-G-073363 44-G-073363			12.87 12.87 12.87		24.0125-0102.1	425102		276 25,0 23,0 V L	
	1.8 2.2 2.3			01.88 01.88 01.88	11.90 11.90 11.90	- verstärktes Fahrwerk 5) - verstärktes Fahrwerk 5) - verstärktes Fahrwerk 5)	24.0122-0118.1	422118		256 22,0 20,0 V +B	
	1.8 2.2 2.3			01.88 01.88 01.88	11.90 11.90 11.90	+ verstärktes Fahrwerk 6) + verstärktes Fahrwerk 6) + verstärktes Fahrwerk 6)	24.0125-0102.1	425102		276 25,0 23,0 V L	
	1.8 2.2 2.3		44-G-200000 44-G-200000 44-G-200000	10.84 08.85 08.86			83.6224-0300.3	330730	2	L=300	
	1.8 2.2 2.2 Turbo 2.3	44-G-200001 44-G-200001 44-G-200001 44-G-200001			11.90 12.87 12.87 12.87	+ ABS + ABS + ABS	24.5170-0315.3	331309	2	L=315	
	2.2 2.2 Turbo 2.3	44-G-200000 44-G-200000 44-G-200000		08.85 03.86 08.86		- ABS - ABS - ABS	83.6134-0332.3	330716	2	L=330	
	2.2 2.2 2.2 Turbo 2.2 Turbo 2.3 2.3	44-G-200001 44-G-200001 44-G-200001 44-G-200001 44-G-200001		01.88 01.88 01.88 01.88 01.88	12.87 11.90 12.87 11.90 12.87 11.90	- ABS - ABS	24.5113-0380.3	331344	2	L=382	
	1.8 Avant 1.8 Limousine 2.2 Avant 2.2 Limousine 2.2 Turbo Avant 2.2 Turbo Limousine 2.3 Avant 2.3 Limousine			10.84 10.84 10.84 03.86 03.86 08.86 08.86	12.87 12.87 12.87 12.87 12.87 12.87 12.87	- erhöhte Zuladung 7) - erhöhte Zuladung 7) - erhöhte Zuladung 7) - erhöhte Zuladung 7) - erhöhte Zuladung 7) - erhöhte Zuladung 7) - erhöhte Zuladung 7)	24.0101-3601.2	260044		Bremsattel-Zubehör	LUC
	1.8 Avant 1.8 Limousine 2.2 Avant 2.2 Limousine 2.2 Turbo Avant 2.2 Turbo Limousine 2.3 Avant 2.3 Limousine			01.88 01.88 01.88 01.88 01.88 01.88 01.88	11.90 11.90 11.90 11.90 11.90 11.90 11.90	- erhöhte Zuladung 7) - erhöhte Zuladung 7) - erhöhte Zuladung 7) - erhöhte Zuladung 7) - erhöhte Zuladung 7) - erhöhte Zuladung 7) - erhöhte Zuladung 7)	24.3384-1704.5 24.3384-1703.5 24.0101-3601.2	240056 240055 260044		D=38, - Halter D=38, - Halter Bremsattel-Zubehör	LUC LUC LUC
	1.8 Avant 2.2 Avant 2.2 Turbo Avant 2.3 Avant			10.84 03.86 08.86	11.90 11.90 11.90	+ erhöhte Zuladung 8) + erhöhte Zuladung 8) + erhöhte Zuladung 8)	24.3434-1702.5 24.3434-1701.5 11.0101-5403.2	240358 240357 260010		D=43, - Halter D=43, - Halter Fallenbalsatz	LUC LUC LUC
	2.3 Avant			08.86	11.90	+ erhöhte Zuladung 8)					

1) + hydraulic booster / + servofreno idraulico / + amplificateur hydraulique / + servo hidráulico

2) - hydraulic booster / - servofreno idraulico / - amplificateur hydraulique / - servo hidráulico

3) standard TMC / PFT standard / MCT standard / CMT standard





























4) compact TMC / PFT compatta / MCT compact / CMT compacto

5) - reinforced suspension / - sospensione rinforzata / - châssis renforcé / - suspensión reforzada

6) + reinforced suspension / + sospensione rinforzata / + châssis renforcé / + suspensión reforzada

7) - increased payload / - carico utile maggiorato / - charge utile augmentée / - incremento de carga

8) + increased payload / + carico utile maggiorato / + charge utile augmentée / + incremento de carga





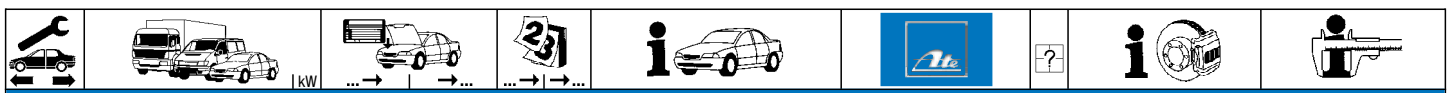































								
AUDI 100 Quattro (85-90)								
	1.8 2.2 2.2 Turbo 2.3			10.84 11.90 10.84 11.90 03.86 11.90 08.86 11.90		13.0460-3602.2 603602		21144 15,8 /S LUC
	1.8 1.8 Avant 2.2 Avant 2.2 Limousine 2.2 Turbo Avant 2.2 Turbo Limousine 2.3 Avant 2.3 Limousine			10.84 11.90 10.84 11.90 - erhöhte Zuladung ¹⁾ 10.84 11.90 - erhöhte Zuladung ¹⁾ 03.86 11.90 - erhöhte Zuladung ¹⁾ 03.86 11.90 - erhöhte Zuladung ¹⁾ 08.86 11.90 - erhöhte Zuladung ¹⁾ 08.86 11.90		24.0110-0207.1 410207 24.0110-0116.1 410116		245 10,0 8,0 245 9,9 8,0 +B
	1.8 2.2 2.2 Turbo 2.3			10.84 11.90 10.84 11.90 03.86 11.90 08.86 11.90		24.0120-0137.1 420137		269 19,9 18,0 V +B
	1.8 2.2 2.2 Turbo 2.3			10.84 11.90 10.84 11.90 03.86 11.90 08.86 11.90		24.5113-0220.3 331318	2	L=220
	1.8 2.2 2.2 Turbo 2.3			10.84 11.90 10.84 12.87 03.86 11.90 08.86 11.90		03.2419-9610.3 030029		Gz 19,05
	1.8 2.2 2.2 Turbo 2.3			10.84 12.87 10.84 12.87 03.86 12.87 08.86 12.87		03.2522-4211.3 040017		Nz 22,20
	1.8 2.2 2.2 Turbo 2.3			01.88 11.90 01.88 11.90 01.88 11.90 01.88 11.90		03.2522-4300.3 040085		Nz 22,20
AUDI 100 Quattro (91-94)								
	S4 S4	169		10.92 07.94 08.91 07.94		10.0124-3202.3 340011		Hydraulik Verstärker
	S4 S4	169		10.92 07.94 08.91 07.94		03.2125-3610.3 010214		THz 25,40 ATE
	2.0 2.3			12.90 07.94 12.90 07.94		11.3571-8506.2 220126 24.3571-8505.5 240489 24.3571-8506.5 240490 11.0441-5704.2 250034 11.0101-5409.2 260035 11.8171-0008.1 990049 11.8116-0143.1 390513	2	D=57, - Halter ATE D=57, - Halter ATE D=57, - Halter ATE Dichtungssatz ATE Hülssensatz ATE Führungsbolzen ATE Haltefeder ATE
	2.6 2.8			03.92 07.94 12.90 07.94		11.3571-8508.2 220128 24.3571-8507.5 240555 24.3571-8508.5 240556 11.8170-0306.1 260102 11.0441-5704.2 250034 11.0101-5409.2 260035 11.8171-0008.1 990049 11.8116-0143.1 390513	2	D=57, - Halter ATE D=57, - Halter ATE D=57, - Halter ATE Halter ATE Dichtungssatz ATE Hülssensatz ATE Führungsbolzen ATE Haltefeder ATE
	S4	169	4A-P-150000	08.91		11.0441-6003.2 250037		Dichtungssatz
	2.0 2.3 2.6 2.8			12.90 07.94 12.90 07.94 03.92 07.94 12.90 07.94		13.0460-7050.2 607050		20678 19,5 +/WK ATE
	S4	169	4A-P-150000	08.91		13.0460-2847.2 602847 24.8190-0105.2 620105	2	21219 17,8 +/WE ATE Warnkontakt L=240mm
	S4 S4	169	4A-R-000001	10.92 07.94 07.94		13.0460-2717.2 602717		21452 18,5 +/WK/S LUC
	2.0 2.3			12.90 07.94 12.90 07.94		24.0115-0105.1 415105 24.0315-0105.1 515105		288 15,0 13,0 L +B 288 15,0 13,0 L +B PD
	2.6 2.8			03.92 07.94 12.90 07.94		24.0125-0105.1 425105 24.0325-0105.1 525105		288 25,0 23,0 V L +B 288 25,0 23,0 V L +B PD
	S4 S4	169	4A-R-000001	10.92 07.94 07.94		24.0130-0104.1 430104		314 30,0 28,0 V L +B
	2.0 2.3 2.6 2.8			12.90 07.94 12.90 07.94 03.92 07.94 12.90 07.94		24.3384-1704.5 240056 24.3384-1703.5 240055 24.0101-3601.2 260044	2	D=38, - Halter LUC D=38, - Halter LUC Bremsattel-Zubehör LUC
	S4 S4	169		10.92 07.94 08.91 07.94		24.3434-1702.5 240358 24.3434-1701.5 240357 11.0101-5403.2 260010	2	D=43, - Halter LUC D=43, - Halter LUC Fallenbalsatz LUC

¹⁾ - increased payload / - carico utile maggiorato / - charge utile augmentée / - incremento de carga
²⁾ + increased payload / + carico utile maggiorato / + charge utile augmentée / + incremento de carga



AUDI 100 Quattro (91-94)												
	2.0 2.3 2.6 2.8 S4 S4			12.90 12.90 03.92 07.92 10.92 08.91	07.94 07.94 07.94 07.94 07.94 07.94			13.0460-3602.2	603602		21144 15,8 /S	LUC
	2.0 2.3 2.6 2.8 S4 S4			12.90 12.90 03.92 12.90 10.92 08.91	07.94 07.94 07.94 07.94 07.94 07.94	- (N) - (N) - (N) - (N) - (N) - (N)		24.0110-0201.1 24.0310-0201.1	410201 510201		245 10,0 8,0 +B 245 10,0 8,0 +B PD	
	2.0 2.3 2.8 S4 S4		4A-M-150000 4A-M-150000 4A-M-150000	12.90 12.90 12.90				24.5113-0220.3	331318	2	L=220	
	2.0 2.3 2.6 2.8 S4 S4	4A-N-000001 4A-N-000001 4A-N-000001		07.94 07.94 03.92 07.94 10.92 08.91				24.5113-0209.3	331300	2	L=209	
	2.0 2.0 2.3 2.3 2.6 2.6 2.8 2.8 S4 S4		4A-P-038000 4A-P-038000 4A-P-038000 4A-P-038000 4A-P-038000 4A-P-038000	12.90 12.90 12.90 03.92 03.92 12.90 12.90 08.91	07.94 07.94 07.94 07.94 07.94 07.94			03.2419-9610.3	030029		Gz 19,05	
	2.0 2.3 2.6 2.8 S4 S4	4A-P-038001 4A-P-038001 4A-P-038001 4A-P-038001		07.94 07.94 07.94 07.94				24.2419-1731.3	030121		Gz 19,05	
	2.0 2.3 2.6 2.8 S4 S4			12.90 12.90 03.92 12.90 12.90 08.91	07.94 07.94 07.94 07.94 07.94 07.94			03.2522-4300.3	040085		Nz 22,20	
AUDI 200 Quattro (85-91)												
	2.2			11.84	11.90			10.0124-3202.3	340011		Hydraulik Verstärker	
	2.2 Limousine			11.84	12.87			03.2123-8512.3	010194		THz 23,81	ATE
	2.2 2.2 2.2 Avant	121 147	44-J-300000 44-J-300000	01.88 01.88				03.2125-2510.3	010209		THz 25,40	ATE
	2.2 2.2	121 147	44-K-000001 44-K-000001		11.90 11.90			03.2125-3210.3	010212		THz 25,40	ATE
	2.2	162		03.89	11.90			03.2125-3610.3	010214		THz 25,40	ATE
	2.2		44-G-073362	11.84				24.3541-1719.5 24.3541-1720.5 24.0101-4301.2 11.0101-5403.2	240057 240058 260047 260010	<input type="checkbox"/> <input type="checkbox"/>	D=54, - Halter D=54, - Halter Bremsattel-Zubehör Fallenbalgsatz	LUC LUC LUC LUC
	2.2 2.2 2.2 2.2 2.2		44-G-073363 44-K-045093 44-K-045093	11.84 01.88 01.88	12.87 11.90 11.90			13.0460-2925.2 13.0460-2963.2	602925 602963		20901 19,0 +WK/S 21138 18,8 +WK/S	LUC LUC
	2.2 2.2 2.2	121 147	44-K-045094 44-K-045094		11.90 11.90			13.0460-5403.2 13.0460-2963.2	605403 602963		21211 18,7 +WE 21138 18,8 +WK/S	ATE LUC
	2.2	162		03.89	11.90			13.0460-2847.2	602847		21219 17,8 +WE	ATE
	2.2 2.2 2.2		44-G-073362 44-G-073363	11.84	12.87 01.88 01.88			24.0122-0120.1 24.0125-0102.1	422120 425102		280 22,0 20,0 V L 276 25,0 23,0 V L	
	2.2 2.2 2.2		44-G-200000 44-G-200001	11.84	12.87 01.88 01.88			83.6224-0300.3 24.5113-0380.3	330730 331344	2	L=300 L=382	
	2.2 2.2 2.2	121 147		03.89 11.90	11.90			83.7813-0252.3	330796	2	L=250	
	2.2 Limousine 2.2 Limousine 2.2 Limousine			11.84 01.88 01.88	12.87 11.90 11.90			24.0101-3601.2 24.3384-1704.5 24.3384-1703.5 24.0101-3601.2	260044 240056 240055 260044	<input type="checkbox"/> <input type="checkbox"/> <input type="checkbox"/>	Bremsattel-Zubehör D=38, - Halter D=38, - Halter Bremsattel-Zubehör	LUC LUC LUC
	2.2 Avant 2.2 Limousine	162		11.84 03.89	11.90 11.90			24.3434-1702.5 24.3434-1701.5 11.0101-5403.2	240358 240357 260010	<input type="checkbox"/> <input type="checkbox"/> <input type="checkbox"/>	D=43, - Halter D=43, - Halter Fallenbalgsatz	LUC LUC LUC



											
AUDI 200 Quattro (85-91)											
	2.2			11.84	11.90		13.0460-3602.2	603602	21144 15,8 /S	LUC	
	2.2 Limousine			11.84	12.87		24.0110-0116.1	410116	245 9,9 8,0 +B		
	2.2 Limousine	121		01.88	11.90						
	2.2 Limousine	147		01.88	11.90						
	2.2 Avant			11.84	11.90		24.0120-0137.1	420137	269 19,9 18,0 V +B		
	2.2 Limousine	162		03.89	11.90						
	2.2			11.84	11.90		24.5113-0220.3	331318	2	L=220	
	2.2			11.84	11.90		03.2419-9610.3	030029		Gz 19,05	
	2.2			11.84	12.87		03.2522-4211.3	040017		Nz 22,20	
	2.2			01.88	11.90		03.2522-4300.3	040085		Nz 22,20	
AUDI 200 (80-83)											
	2.2			10.79	08.83	+ Hydraulikverstärker ¹⁾	10.0124-3202.3	340011		Hydraulik Verstärker	
	2.2			10.79	08.83		13.0460-2934.2	602934		20669 19,0 /S	LUC
	2.2			10.79	08.83		24.0122-0120.1	422120		280 22,0 20,0 V L	
	2.2			10.79	08.83		83.6134-0332.3	330716	2	L=330	
	2.2			10.79	08.83		13.0460-3602.2	603602		21144 15,8 /S	LUC
	2.2			10.79	08.83		24.0110-0154.1	410154		245 10,0 8,0	
	2.2			10.79	08.83		83.7824-0180.3	330812	2	L=180	
	2.2						24.5170-0161.3	331308	2	L=161	
	2.2			10.79	08.83	- Niveauregulierung ³⁾	03.6565-0101.3	320097		BRL 6/5 (4)	ATE
	2.2			10.79	08.83		03.2419-9610.3	030029		Gz 19,05	
	2.2			10.79	08.83		03.2522-4211.3	040017		Nz 22,20	
AUDI 200 (84-91)											
	2.1			08.83	01.88		10.0124-3202.3	340011		Hydraulik Verstärker	
	2.2			08.84	12.90						
	2.1			08.83	01.88	- erhöhte Zuladung ⁴⁾	03.2123-8512.3	010194		THz 23,81	ATE
	2.2			08.84	01.88	- erhöhte Zuladung ⁴⁾					
	2.1			08.83	01.88	+ erhöhte Zuladung ⁵⁾	03.2125-2510.3	010209		THz 25,40	ATE
	2.2			08.84	01.88	+ erhöhte Zuladung ⁵⁾					
	2.1		44-G-073362	08.83			24.3541-1719.5	240057		D=54, - Halter	LUC
	2.2		44-G-073362	08.84			24.3541-1720.5	240058		D=54, - Halter	LUC
	2.1		44-G-073362	08.83			24.0101-4301.2	260047		Bremssattel-Zubehör	LUC
	2.2		44-G-073362	08.84			11.0101-5403.2	260010		Faltenbalsatz	LUC
	2.1		44-G-073362	08.83			13.0460-2925.2	602925		20901 19,0 +/WK/S	LUC
	2.2		44-G-073362	08.84							
	2.1	44-G-073363			01.88		13.0460-2963.2	602963		21138 18,8 +/WK/S	LUC
	2.2	44-G-073363	44-K-045093								
	2.2	44-K-045094			12.90		13.0460-5403.2	605403		21211 18,7 +/WE	ATE
	2.1						13.0460-2963.2	602963		21138 18,8 +/WK/S	LUC
	2.1		44-G-073362	08.83			24.0122-0120.1	422120		280 22,0 20,0 V L	
	2.2		44-G-073362	08.84							
	2.1	44-G-073363			01.88		24.0125-0102.1	425102		276 25,0 23,0 V L	
	2.2	44-G-073363			12.90						
	2.1		44-G-200000	08.83			83.6224-0300.3	330730	2	L=300	
	2.2		44-G-200000	08.84							
	2.1	44-G-200001			01.88		24.5113-0380.3	331344	2	L=382	
	2.2	44-G-200001			12.90						
	2.1			08.83	01.88		24.0101-3601.2	260044		Bremssattel-Zubehör	LUC
	2.2			08.84	01.88						





































¹⁾ + hydraulic booster / + servofreno idraulico / + amplificateur hydraulique / + servo hidráulico

²⁾ on the brake caliper / sulla pinza freno / sur l'étrier de frein / a la pinza de freno

³⁾ - suspension level control / - correttore assetto / - correcteur d'assiette / - regulación altura suspensión

⁴⁾ - increased payload / - carico utile maggiorato / - charge utile augmentée / - incremento de carga























⁵⁾ + increased payload / + carico utile maggiorato / + charge utile augmentée / + incremento de carga

AUDI 200 (84-91)		AUDI COUPE (81-88)					
	2.2		02.88 12.90	24.3384-1603.5 240015 24.3384-1604.5 240016 24.0101-3601.2 260044		D=38, - Halter D=38, - Halter Bremsattel-Zubehör	LUC LUC LUC
	2.1 2.2		08.83 01.88 08.84 12.90	13.0460-3602.2 603602		21144 15,8 /S	LUC
	2.1 2.2		08.83 01.88 08.84 12.90	24.0110-0154.1 410154		245 10,0 8,0	
	2.1 2.2	44-G-073362 44-G-073362	08.83 08.84	83.6204-0240.3 330718 83.6134-0332.3 330716 83.6301-0150.3 330342	 2 	L=240 L=330 L=150	am Bremsattel ¹⁾
	2.1 2.2	44-G-073363 44-G-073363	01.88 12.90	83.7824-0180.3 330812 24.5113-0220.3 331318	2  2	L=180 L=220	am Bremsattel ¹⁾
	2.1 2.2		08.83 01.88 08.84 01.88	24.3727-0138.2 580138	2 	L=1438	
	2.1 2.2		02.88 12.90	24.3727-0130.2 580130	2 	L=1455	
	2.1 2.2		08.83 01.88 08.84 12.90	03.6585-0108.3 320115		BRL 8/5 (4)	ATE
	2.1 2.2		08.83 01.88 08.84 12.90	03.2419-9610.3 030029		Gz 19,05	
	2.1 2.2		08.83 01.88 08.84 01.88	03.2522-4211.3 040017		Nz 22,20	
	2.2		02.88 12.90	03.2522-4300.3 040085		Nz 22,20	
	1.8 2.0 2.2 2.3	85-F-000001 85-F-000001 85-F-000001 85-F-000001	07.88 07.88 07.88 07.88	03.7750-0302.4 300071		9"	ATE
	1.6 1.8	85-F-000001	02.81 08.81	03.2120-1531.3 010092		THz 20,64	ATE
	2.0 2.0 2.2 2.3 2.3	85 85-F-000001 85 85-F-000001 85-F-000001 100 100	07.88 07.88 07.88 02.87 02.87	03.2122-9612.3 010159		THz 22,20	ATE
	2.0 2.2 2.3	85-F-000001 85-F-000001	07.87 07.88 02.87	24.3541-1609.5 240039 24.3541-1610.5 240040 24.0101-4301.2 260047 11.0101-5403.2 260010	 	D=54, - Halter D=54, - Halter Bremsattel-Zubehör Fallenbalgsatz	LUC LUC LUC LUC
	1.8 2.2	85-F-000001 96	07.88 09.81	13.0460-2936.2 602936		20574 15,3 /S	LUC
	2.0 2.2 2.3	85-F-000001 85-F-000001	07.87 07.88 02.87	13.0460-2926.2 602926		20669 15,7 /S	LUC
	1.6 1.8 1.9 2.0 2.2 2.2		02.81 08.81 08.81 08.81 10.80 08.83 09.83 09.83 02.81 08.83 02.81 08.83	24.0112-0106.1 412106 24.0312-0106.1 512106		239 12,0 10,0 +S +B 239 12,0 10,0 +S +B PD	
	1.8 2.2	77 85	02.81 08.83 02.81 08.83	24.0120-0123.1 420123 24.0320-0123.1 520123		239 20,0 18,0 V L +S +B 239 20,0 18,0 V L +S +B PD	
	2.0 2.2 2.3	85-F-000001 85-F-000001	07.87 07.88 02.87	24.0120-0120.1 420120		256 20,0 18,0 V L	
	1.6 1.8 1.9 2.0 2.2 2.3		02.81 08.81 08.81 07.88 10.80 08.83 09.83 07.88 09.84 07.88 02.87 07.88	24.5170-0315.3 331309	2	L=315	
	2.2 2.3	100	09.84 07.88 02.87 07.88	24.0101-3601.2 260044		Bremsattel-Zubehör	LUC
	2.2 2.3	100	09.84 07.88 02.87 07.88	13.0460-3602.2 603602		21144 15,8 /S	LUC
	2.2 2.3	100	09.84 07.88 02.87 07.88	24.0110-0178.1 410178		245 10,0 8,0 +B	
	1.6 1.8 1.9 2.0 2.2 2.2	85 96	02.81 08.81 08.81 07.88 10.80 08.83 09.83 07.88 09.84 07.88 09.84 07.88	83.6224-0200.3 330729 83.7824-0180.3 330812	 	L=200 L=180	
	2.2 2.3	100	08.84 07.88 02.87 07.88	24.5170-0161.3 331308	2	L=161	

¹⁾ on the brake caliper / sulla pinza freno / sur l'étrier de frein / a la pinza de freno

²⁾ - suspension level control / - correttore assetto / - correcteur d'assiette / - regulación altura suspensión

³⁾ + manual transmission / + scatola cambio velocità / + transmission mécanique / + cambio de velocidad

AUDI COUPE (81-88)											
	1.6 1.8		85-E-220000	02.81 08.81	08.81 + Schaltgetriebe ¹⁾ + Schaltgetriebe ¹⁾	03.3214-0812.3	020011		+ GG ²⁾		Rz 14,29
	1.6 1.8 1.8 1.9		85-E-220000	02.81 08.81	08.81 + Automatikgetriebe ³⁾ + Automatikgetriebe ³⁾	03.3215-2311.3 24.3215-0903.3	020018 020154		+ GG ²⁾ + ALU ⁴⁾		Rz 15,87 Rz 15,87
	2.0 2.2 2.2 2.2	77 85 96		09.83 02.81 02.81 02.81	07.87 07.84 +  07.88 07.84	03.3217-2112.3	020027		+ GG ²⁾		Rz 17,46
	1.6 1.8		85-E-220000	02.81 08.81	08.81 + Schaltgetriebe ¹⁾ + Schaltgetriebe ¹⁾	03.0137-0126.2 03.0137-9008.2	650126 669008				180 x 31 HEB Bremsbacken-Zubehör
	1.6 1.8 1.8 1.9		85-E-220000	02.81 08.81	08.81 + Automatikgetriebe ³⁾ + Automatikgetriebe ³⁾	03.0137-0146.2 03.0137-9041.2	650146 669041				200 x 40 HEB Bremsbacken-Zubehör
	2.0 2.2 2.2 2.2	77 85 96		09.83 02.81 02.81 02.81	07.87 07.84 +  07.88 07.84						
	1.6 1.8		85-E-220000	02.81 08.81	08.81 + Schaltgetriebe ¹⁾ + Schaltgetriebe ¹⁾	24.0218-0007.1 24.0218-0707.2	480003 480211				180/181 x 38,5 - Lager 180/181 x 38,5 + Lager
	2.0 2.2	81 85		09.83 02.81	07.87 07.88 + 	24.0220-0016.1	480018				200/201 x 52
	1.6 1.8 1.8 1.9		85-E-220000	02.81 08.81	08.81 + Automatikgetriebe ³⁾ + Automatikgetriebe ³⁾	24.0220-0018.1 24.0220-0718.2	480019 480209		ohne Sensorring ⁵⁾ ohne Sensorring ⁵⁾		200/201 x 50,5 - Lager 200/201,5 x 50,5 + Lager
	2.0 2.0 2.2 2.2	83 85 77 96		10.80 09.83 09.83 04.81	08.83 07.86 07.86 07.84 +  07.84						
	1.6 1.8		85-E-220000	02.81 08.81	08.81 + Schaltgetriebe ¹⁾ + Schaltgetriebe ¹⁾	03.0520-0114.3	690114				14,29/180x31 TopKit VW
	2.0 2.2 2.2 2.2	77 85 96		09.83 02.81 02.81 02.81	07.87 07.84 +  07.88 07.84	03.0420-0417.3	680417				17,46/200x40 Kit VW
	1.6 1.8 1.9 2.0 2.2 2.2			02.81 08.81 10.80 09.83 09.81 09.81	08.81 07.88 08.83 07.88 07.88 07.88	24.3727-0136.2 24.3727-0139.2	580136 580139	<input type="checkbox"/> <input type="checkbox"/>			L=1195 L=1150
	85 96										
	1.6 1.8 1.9 2.0 2.2		85-E-220000	02.81 10.80 10.80 09.83	08.81 08.83 08.83	03.6565-0101.3	320097				BRL 6/5 (4) ATE
	1.8 2.0	100 85	85-F-000001 85-F-000001		07.87 +  	03.6585-0108.3	320115				BRL 8/5 (4) ATE
	2.2 2.3	100		09.84 02.87	07.88 07.88	03.2419-8150.3	030019				Gz 19,05
	2.2 2.3	100		09.84 02.87	07.88 07.88	03.2522-4211.3	040017				Nz 22,20
AUDI COUPE Quattro (85-87)											
	2.2 2.3			12.84 01.87	12.87 12.87	03.7750-0302.4	300071				9" ATE
	2.2 2.3			12.84 01.87	12.87 12.87	03.2122-9612.3	010159				THz 22,20 ATE
	2.2 2.3			12.84 01.87	12.87 12.87	24.3541-1609.5 24.3541-1610.5 24.0101-4301.2 11.0101-5403.2	240039 240040 260047 260010	<input type="checkbox"/> <input type="checkbox"/>			D=54, - Halter D=54, - Halter Bremsattel-Zubehör Faltenbalsatz LUC LUC LUC LUC
	2.2 2.3			12.84 01.87	12.87 12.87	13.0460-2926.2	602926				20669 15,7 /S LUC
	2.2 2.3			12.84 01.87	12.87 12.87	24.0120-0120.1	420120				256 20,0 18,0 V L
	2.2 2.3			12.84 01.87	12.87 12.87	24.5170-0315.3	331309	2			L=315
	2.2 2.3			12.84 01.87	12.87 12.87	24.0101-3601.2	260044				Bremsattel-Zubehör LUC

1) + manual transmission / + scatola cambio velocità / + transmission mécanique / + cambio de velocidad
2) + cast iron / + ghisa / + fonte grise / + fundición de gris
3) + autom.transmission / + scatola cambio automatico / + transmission automatique / + cambio automático
4) + aluminium / + alluminio / + aluminium / + aluminio
5) without sensor ring / senza sensori / sans secours ABS / sin anillo sensor ABS

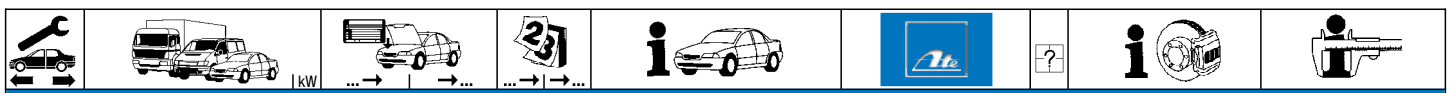











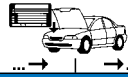











AUDI COUPE Quattro (85-87)												
	2.2 2.3				12.84 01.87	12.87 12.87			13.0460-3602.2	603602	21144 15,8 /S	LUC
	2.2 2.3				12.84 01.87	12.87 12.87			24.0110-0182.1	410182	245 10,0 8,0 +B	
	2.2 2.3				12.84 01.87	12.87 12.87			83.6104-0250.3	330720	L=250	
	2.2 2.3				12.84 01.87	12.87 12.87			03.6058-0301.3	320072	BR 25/5 (3)	ATE
	2.2 2.3				12.84 01.87	12.87 12.87			03.2419-8150.3	030019	Gz 19,05	
	2.2 2.3				12.84 01.87	12.87 12.87			03.2522-4211.3	040017	Nz 22,20	

AUDI COUPE (89-96)												
	1.8 2.0 2.0 16V 2.0 20V 2.3 2.3			8B-N-500000 08.88 8B-N-500000 08.88 8B-N-500000 01.92 8B-N-500000 08.89 8B-N-500000 03.90 8B-N-500000 08.88					03.7750-0302.4	300071	9"	ATE
	2.3 20V 2.3 20V	123 125		8B-M-020000 08.90 8B-M-020000 08.89					10.0124-3202.3	340011	Hydraulik Verstärker	
	1.8 1.8 2.0 2.0 2.3 2.3 2.3 2.3 2.3			08.88 08.89 08.88 08.88 03.90 03.90 08.88 08.88 08.88	07.89 07.91 - ABS 07.92 - ABS 12.96 - ABS 07.92 - ABS 07.94 - ABS 07.92 - ABS 07.94 - ABS			03.2120-2331.3 03.2122-9612.3	010110 010159		Thz 20,64 Thz 22,20	ATE ATE
	2.0 2.3 2.3 2.8			08.92 08.92 08.92 09.91	12.96 - ABS/ - Hydraulikverstärker 1) 12.96 - ABS 07.94 - ABS 12.96 - ABS			03.2123-0491.3	010167		Thz 23,81	ATE
	1.8 2.0 2.0 2.3 2.3 2.3 2.3			08.89 05.89 05.89 03.90 03.90 11.88 11.88	07.91 + ABS 07.92 + ABS 12.96 + ABS/ - Hydraulikverstärker 2) 07.92 + ABS 07.94 + ABS 07.92 + ABS 07.94 + ABS			24.2122-1601.3	010380		Thz 22,20	LUC
	2.0 2.3 2.3 2.6 2.8			08.92 08.92 08.92 08.92 09.91	12.96 + ABS/ - Hydraulikverstärker 2) 12.96 + ABS 07.94 + ABS 06.94 - Hydraulikverstärker 3) 06.94 + ABS/ - Hydraulikverstärker 2)			24.2123-1602.3	010384		Thz 23,81	LUC
	2.0 2.6 2.8			07.94 08.92 09.91	12.96 + Hydraulikverstärker 4) 12.96 + Hydraulikverstärker 4) 12.96 + Hydraulikverstärker 4)			03.2123-0566.3 03.3517-0101.2	010169 390322		Thz 23,81 Verschlusschraube	ATE
	2.3 20V 2.3 20V	123 125		08.90 08.89	07.91 07.91			03.2125-3210.3	010212		Thz 25,40	ATE
	2.3 1.8 2.0 2.3 2.3			08.88 08.88 05.89 03.90 11.88	10.88 07.91 07.92 07.92 07.92			24.3541-1609.5 24.3541-1610.5 24.0101-4301.2 11.0101-5403.2	240039 240040 260047 260010	<input type="checkbox"/> <input type="checkbox"/>	D=54, - Halter D=54, - Halter Bremsattel-Zubehör Faltenbalgsatz	LUC LUC LUC LUC
	2.0 2.3 2.3 2.6			08.92 08.92 08.92 08.92	12.96 12.96 07.94 12.96			11.3541-8521.2 24.3541-1720.5 24.3541-1719.5 11.0441-5405.2 11.0101-5409.2 24.0101-4301.2 11.0101-5403.2	220113 240058 240057 250030 260035 260047 260010	<input type="checkbox"/> <input type="checkbox"/> <input type="checkbox"/> <input type="checkbox"/>	D=54, - Halter D=54, - Halter D=54, - Halter Dichtungssatz Hülssensatz Bremsattel-Zubehör Faltenbalgsatz	ATE LUC LUC ATE ATE LUC LUC
	2.3 20V 2.3 20V 2.8	123 125		08.90 08.89 09.91	07.91 07.91 12.96			24.0101-3401.2 11.0101-5403.2	260043 260010		Bremsattel-Zubehör Faltenbalgsatz	LUC LUC
	2.3 1.8 2.0 2.3 2.3 2.6			08.88 08.88 03.90 11.88 08.92	10.88 07.91 12.96 07.94 12.96			13.0460-2926.2 13.0460-2934.2	602926 602934		20669 15,7 /S 20669 19,0 /S	LUC LUC
	2.3 20V 2.3 20V 2.8	123 125		08.90 08.89 09.91	07.91 07.91 12.96			13.0460-2963.2	602963		21138 18,8 +/WK/S	LUC

1) - ABS/ - hydraulic booster / - ABS/ - servofreno idraulico / - ABS/ - amplificateur hydraulique / - ABS/ - servo hidráulico
2) + ABS/ - hydraulic booster / + ABS/ - servofreno idraulico / + ABS/ - amplificateur hydraulique / + ABS/ - servo hidráulico
3) - hydraulic booster / - servofreno idraulico / - amplificateur hydraulique / - servo hidráulico
4) + hydraulic booster / + servofreno idraulico / + amplificateur hydraulique / + servo hidráulico



























									
AUDI COUPE (89-96)									
	2.3			08.88	10.88	24.0120-0120.1	420120		256 20,0 18,0 V L
	1.8			08.88	07.91	24.0122-0108.1	422108		256 22,0 20,0 V L +B
	2.0			05.89	07.92				
	2.3	98		03.90	07.92				
	2.3	100		11.88	07.92				
	2.0			08.92	12.96	24.0122-0139.1	422139		280 22,0 20,0 V L +B
	2.3	98		08.92	12.96				
	2.3	100		08.92	07.94				
	2.6			08.92	12.96				
	2.3 20V	123		08.90	07.91	24.0125-0106.1	425106		276 25,0 23,0 V L +B
2.3 20V	125		08.89	07.91					
2.8			09.91	12.96					
	1.8		8B-L-003791	08.88		24.5170-0315.3	331309	2	L=315
	2.0		8B-L-003791	08.88					
	2.3		8B-L-003791	08.88					
	1.8	8B-L-003792		07.91		24.5237-0288.3	331442	2	L=288
	2.0	8B-L-003792		12.96		24.5170-0161.3	331308	2	L=161
2.3	8B-L-003792		07.94					am Bremssattel ¹⁾	
2.6			08.92	12.96					
2.8			09.91	12.96					
	2.3			08.88	10.88	24.0101-3601.2	260044		Bremssattel-Zubehör LUC
	1.8			08.88	07.91	24.3384-1601.5	240013	<input type="checkbox"/>	D=38, - Halter LUC
	2.0			08.88	04.93	24.3384-1602.5	240014	<input type="checkbox"/>	D=38, - Halter LUC
	2.3			08.88	04.93	24.0101-3601.2	260044		Bremssattel-Zubehör LUC
	2.6			08.92	04.93				
	2.8			09.91	04.93				
	2.0			05.93	12.96	24.3384-1709.5	240257	<input type="checkbox"/>	D=38, - Halter LUC
	2.3			05.93	07.94	24.3384-1710.5	240258	<input type="checkbox"/>	D=38, - Halter LUC
	2.6			05.93	12.96				
	2.8			05.93	12.96				
	1.8			08.88	07.91	13.0460-3602.2	603602		21144 15,8 /S LUC
	2.0			08.88	12.96				
	2.3			08.88	12.96				
	2.6			08.92	12.96				
	2.8			09.91	12.96				
	1.8			08.88	07.91	24.0110-0178.1	410178		245 10,0 8,0 +B
	2.0			08.88	12.96				
	2.3			08.88	07.94				
	2.6			08.92	12.96				
	2.8			09.91	12.96				
	1.8			08.88	10.88	83.6224-0200.3	330729	<input type="checkbox"/>	L=200
	2.0			08.88	10.88	83.7824-0180.3	330812	<input type="checkbox"/>	L=180
	2.3	100		08.88	10.88	24.5170-0161.3	331308	2	L=161
	1.8			11.88	07.91	83.6224-0200.3	330729	<input type="checkbox"/>	L=200
	2.0			11.88	12.96	83.7804-0150.3	330853	<input type="checkbox"/>	L=150
2.3			11.88	07.94	24.5170-0161.3	331308	2	L=161	
2.6			08.92	12.96				am Bremssattel ¹⁾	
2.8			09.91	12.96					
	1.8			08.88	10.88	03.3215-2311.3	020018	+ GG ²⁾	Rz 15,87
						24.3215-0903.3	020154	+ ALU ³⁾	Rz 15,87
	1.8			08.88	10.88	03.0137-0146.2	650146		200 x 40 HEB
						03.0137-9041.2	669041		Bremsbacken-Zubehör
	1.8			08.88	10.88	24.0220-0018.1	480019	ohne Sensorring ⁴⁾	200/201 x 50,5 - Lager
						24.0220-0718.2	480209	ohne Sensorring ⁴⁾	200/201,5 x 50,5 + Lager
	1.8			08.88	10.88	24.3727-0136.2	580136	<input type="checkbox"/>	L=1195
	2.0			08.88	10.88	24.3727-0139.2	580139	<input type="checkbox"/>	L=1150
	1.8			11.88	07.91	24.3727-0143.2	580143	<input type="checkbox"/>	L=1398
	2.0			11.88	04.93	24.3727-0144.2	580144	<input type="checkbox"/>	L=1358
	2.3			11.88	04.93				
2.6			08.92	04.93					
2.8			09.91	04.93					
	1.8			08.88	07.91	03.6585-0108.3	320115		BRL 8/5 (4) ATE
	2.0	85		08.88	12.96				
	2.0	103		08.88	07.94				
	2.3	98		03.90	12.96				
	2.3	100		08.88	07.94				
2.6			08.92	12.96					
	2.3			08.88	10.88	03.2419-8150.3	030019		Gz 19,05
	1.8			11.88	07.91	03.2419-9210.3	030026		Gz 19,05
	2.0			11.88	12.96				
	2.3			11.88	07.94				
	2.6			08.92	12.96				
2.8			09.91	12.96					
	2.3			08.88	10.88	03.2522-4211.3	040017		Nz 22,20
	1.8			11.88	07.91	03.2522-4300.3	040085		Nz 22,20
	2.0			11.88	12.96				
	2.3			11.88	07.94				
	2.6			08.92	12.96				
2.8			09.91	12.96					

¹⁾ on the brake caliper / sulla pinza freno / sur l'étrier de frein / a la pinza de freno

²⁾ + cast iron / + ghisa / + fonte grise / + fundición de gris

³⁾ + aluminium / + aluminio / + aluminium / + aluminio

⁴⁾ without sensor ring / senza sensori / sans secours ABS / sin anillo sensor ABS

















								
AUDI COUPE Quattro (87-96)								
	2.2 2.3 2.3	100 98 100		01.88 07.91 05.90 12.96 01.88 07.94	03.7750-0302.4	300071		9" ATE
	2.0 2.3 20V 2.3 20V S2 S2	123 125 162 169		11.88 07.91 + F I 05.90 12.96 11.88 07.91 09.90 09.92 10.92 12.96	10.0124-3202.3	340011		Hydraulik Verstärker
	2.0 2.6 2.8			11.88 07.91 + F I 08.92 12.96 + Hydraulikverstärker 1) 08.91 12.96 + Hydraulikverstärker 1)	03.2123-0566.3 03.3517-0101.2	010169 390322		THz 23,81 Verschlusschraube ATE
	2.2 2.3 2.3	100 98 100		01.88 07.91 - ABS 05.90 12.96 - ABS 01.88 07.94 - ABS	03.2122-9612.3	010159		THz 22,20 ATE
	2.2 2.3 2.3	100 98 100		11.88 07.91 + ABS 05.90 12.96 + ABS 11.88 07.94 + ABS	24.2122-1601.3	010380		THz 22,20 LUC
	S2 S2	162 169		09.90 09.92 10.92 12.96	03.2125-3610.3	010214		THz 25,40 ATE
	2.3 20V 2.3 20V	123 125		05.90 12.96 11.88 07.91	03.2125-3210.3	010212		THz 25,40 ATE
	2.2 2.3 2.3 2.6	100 98 100		01.88 07.91 05.90 07.92 01.88 07.92 08.92 12.96	11.3541-8521.2 24.3541-1720.5 24.3541-1719.5 11.0441-5405.2 11.0101-5409.2 24.0101-4301.2 11.0101-5403.2	220113 240058 240057 250030 260035 260047 260010	   	D=54, - Halter ATE D=54, - Halter LUC D=54, - Halter LUC Dichtungssatz ATE Hülzensatz ATE Bremsattel-Zubehör LUC Faltenbalgsatz LUC
	2.3 2.3	98 100		08.92 12.96 08.92 07.94	24.3541-1720.5 24.3541-1719.5 24.0101-4301.2 11.0101-5403.2	240058 240057 260047 260010	 	D=54, - Halter LUC D=54, - Halter LUC Bremsattel-Zubehör LUC Faltenbalgsatz LUC
	2.0 2.3 20V 2.3 20V 2.8 S2 S2	100 123 125 162 169	8B-L-003001 8B-L-003001 8B-L-003001	07.91 + F I 12.96 07.91 08.91 12.96 09.90 09.92 10.92 12.96	24.0101-3401.2 11.0101-5403.2	260043 260010		Bremsattel-Zubehör LUC Faltenbalgsatz LUC
	2.2 2.3 2.3 2.6	100 98 100		01.88 07.91 05.90 12.96 01.88 07.94 08.92 12.96	13.0460-2934.2	602934		20669 19,0 / S LUC
	2.0 2.3 20V 2.3 20V 2.8 S2 S2	123 125 162 169		11.88 07.91 + F I 05.90 12.96 11.88 07.91 08.91 12.96 09.90 09.92 10.92 12.96	13.0460-2963.2	602963		21138 18,8 +/WK/S LUC
	2.0 2.3 20V 2.3 20V 2.8	123 125		11.88 07.91 + F I 05.90 12.96 11.88 07.91 08.91 12.96 + 15" Rad 2)	24.0125-0106.1	425106		276 25,0 23,0 V L + B
	2.2 2.3 2.3	100 98 100	8B-N-015000 8B-N-015000 8B-N-015000	01.88 05.90 01.88	24.0122-0108.1	422108		256 22,0 20,0 V L + B
	2.3 2.3 2.6	98 100	8B-P-000001 8B-P-000001	12.96 07.94 08.92 12.96 + 15" Rad 2)	24.0122-0139.1	422139		280 22,0 20,0 V L + B
	2.6 2.8 S2 S2	162 169		08.92 12.96 + 16" Rad 3) 08.91 12.96 + 16" Rad 3) 09.90 09.92 10.92 12.96	24.0125-0139.1	425139		276 24,9 23,0 V L + B
	2.0 2.2 2.3 2.3	100 98 100	8B-L-003000 8B-L-003000 8B-L-003000 8B-L-003000	11.88 01.88 05.90 01.88	24.5170-0315.3	331309	2	L=315
	2.3 20V 2.3 20V	123 125	8B-L-003000 8B-L-003000	05.90 11.88	24.5113-0380.3	331344	2	L=382
	2.0 2.2 2.3 2.3 2.3 20V 2.3 20V 2.6 2.8 S2 S2	100 100 98 100 123 125 162 169	8B-L-003001 8B-L-003001 8B-L-003001 8B-L-003001 8B-L-003001 8B-L-003001	07.91 + F I 07.91 12.96 07.94 12.96 07.91 08.92 12.96 08.91 12.96 09.90 09.92 10.92 12.96	24.5237-0288.3 24.5170-0161.3	331442 331308	2 2	am Bremsattel 4) L=288 L=161
	2.0 2.2 2.3 2.3 2.3 20V 2.3 20V 2.6	100 98 100 123 125		11.88 07.91 + F I 01.88 07.91 05.90 12.96 01.88 07.94 05.90 12.96 11.88 07.91 08.92 12.96	24.3384-1703.5 24.3384-1704.5 24.0101-3601.2	240055 240056 260044	 	D=38, - Halter LUC D=38, - Halter LUC Bremsattel-Zubehör LUC

1) + hydraulic booster / + servofreno idraulico / + amplificateur hydraulique / + servo hidráulico

2) + 15" wheel / + ruota 15" / + roue 15" / + rueda 15"

























3) + 16" wheel / + ruota 16" / + roue 16" / + rueda 16"

4) on the brake caliper / sulla pinza freno / sur l'étrier de frein / a la pinza de freno































AUDI COUPE Quattro (87-96)												
	2.8 S2 S2	162		08.91 09.90 10.92	12.96 09.92 12.96			24.3384-1703.5 24.3384-1704.5 24.0101-3601.2	240055 240056 260044	 	D=38, - Halter D=38, - Halter Bremsattel-Zubehör	LUC LUC LUC
	2.0 2.2 2.3 2.3 2.3 20V 2.3 20V 2.6 2.8 S2 S2	100 98 100 123 125 162 169		11.88 01.88 05.90 01.87 05.90 11.88 08.92 08.91 09.90 10.92	07.91 07.91 12.96 07.94 12.96 07.91 12.96 12.96 09.92 12.96	+ F I		13.0460-3602.2	603602		21144 15,8 /S	LUC
	2.0 2.2 2.3 2.3 2.3 20V 2.3 20V 2.6 2.8 S2 S2	100 98 100 123 125 162 169		11.88 01.88 05.90 01.88 05.90 11.88 08.92 08.91 09.90 10.92	07.91 07.91 12.96 07.94 12.96 07.91 12.96 12.96 + 15" Rad 1) + 15" Rad 1) + 15" Rad 1) + 15" Rad 1)	+ F I		24.0110-0182.1	410182		245 10,0 8,0 +B	
	2.6 2.8 S2 S2	162 169		08.92 08.91 09.90 10.92	12.96 12.96 12.96 12.96	+ 16" Rad 2) + 16" Rad 2) + 16" Rad 2) + 16" Rad 2)		24.0110-0261.1 24.0310-0261.1	410261 510261		245 10,0 8,0 +B 245 10,0 8,0 +B PD	
	2.0 2.2 2.3 2.3 2.3 20V 2.3 20V 2.6 2.8 S2 S2	100 98 100 123 125 162 169		11.88 01.88 05.90 01.88 05.90 11.88 08.92 08.91 09.90 10.92	07.91 07.91 12.96 07.94 12.96 07.91 12.96 12.96 + 15" Rad 1) + 15" Rad 1) + 15" Rad 1)	+ F I		83.6104-0250.3	330720	2	L=250	
	2.0 2.2 2.3 2.3 2.3 20V 2.3 20V 2.6 2.8 S2 S2	100 98 100 123 125 162 169		11.88 01.88 05.90 01.88 05.90 11.88 08.92 08.91 09.90 10.92	07.91 07.91 12.96 07.94 12.96 07.91 12.96 12.96 + 15" Rad 1) + 15" Rad 1) + 15" Rad 1)	+ F I		03.2419-9210.3	030026		Gz 19,05	
	2.0 2.2 2.3 2.3 2.3 20V 2.3 20V 2.6 2.8 S2 S2	100 98 100 123 125 162 169		11.88 01.88 05.90 01.88 05.90 11.88 08.92 08.91 09.90 10.92	07.91 07.91 12.96 07.94 12.96 07.91 12.96 12.96 + 15" Rad 1) + 15" Rad 1) + 15" Rad 1)	+ F I		03.2522-4300.3	040085		Nz 22,20	
AUDI QUATTRO (80-91)												
	2.2 2.2	119 147	85-H-902400 85-H-902400	08.84 07.80				10.0522-4005.1 10.0522-4002.1 10.0515-0515.3	340029 340028 340024		Warnschalter M10x1 Warnschalter M12x1 Hydraulikspeicher	ATE
	2.2 2.2		85-C-901032 85-H-900551					03.2123-8512.3 03.2125-2510.3	010194 010209		THz 23,81 THz 25,40	ATE ATE
	2.2 2.2	119 147	85-D-900001 85-D-900001	85-G-902400 85-G-902400				24.3541-1719.5 24.3541-1720.5 24.0101-4301.2 11.0101-5403.2	240057 240058 260047 260010	 	D=54, - Halter D=54, - Halter Bremsattel-Zubehör Fallenbalgsatz	LUC LUC LUC LUC
	2.2 2.2 2.2 2.2 2.2	119 147 119 147 162	85-D-900001 85-D-900001 85-H-900001 85-H-900001 85-H-900001	85-G-902400 85-G-902400				13.0460-2934.2 13.0460-2963.2	602934 602925 602963		20691 19,0 +WK/S 21138 18,8 +WK/S	LUC LUC
	2.2 2.2 2.2	119 147 119	85-G-902400 85-G-902400 85-H-900001	08.84 07.80				24.0122-0120.1 24.0125-0102.1	422120 425102		280 22,0 20,0 V L 276 25,0 23,0 V L	
	2.2 2.2 2.2	119 147 162	85-G-902400 85-G-902400 85-H-900001	08.84 07.80				83.6134-0332.3 24.5113-0380.3	330716 331344	2 2	L=330 L=382	

1) + 15" wheel / + ruota 15" / + roue 15" / + rueda 15"

2) + 16" wheel / + ruota 16" / + roue 16" / + rueda 16"

AUDI QUATTRO (80-91)		AUDI V8 (88-94)		AUSTIN METRO (80-90)		AUSTIN MINI (67-93)	
	2.2 2.2 2.2	119 85-E-900001 147 85-E-900001 162		07.89 07.91 08.89 07.91		24.0101-3601.2 260044 24.3434-1701.5 240357 24.3434-1702.5 240358 11.0101-5403.2 260010	Bremssattel-Zubehör LUC D=43, - Halter LUC D=43, - Halter LUC Fallenbalgsatz LUC
	2.2 2.2 2.2	119 147 162		08.84 07.89 07.80 07.91 07.80 07.91		13.0460-3602.2 603602	21144 15,8 /S LUC
	2.2 2.2 2.2	119 147 162		08.84 07.89 07.80 07.91 08.89 07.91		24.0110-0154.1 410154 24.0120-0172.1 420172	245 10,0 8,0 269 19,9 18,0 V L
	2.2		85-D-902500	07.80		24.5170-0315.3 331309	L=315
	2.2 2.2 2.2	119 85-E-900001 147 85-E-900001 162 85-E-900001		07.89 07.91 07.91		83.6104-0250.3 330720	L=250
	2.2 2.2	119 147		08.84 07.89 07.80 07.91		03.6058-0301.3 320072	BR 25/5 (3) ATE
	2.2			07.80 07.91		03.2419-8150.3 030019	Gz 19,05
	2.2		85-J-900108	07.80		03.2522-4211.3 040017	Nz 22,20
	2.2	85-J-900109		07.91		03.2522-4300.3 040085	Nz 22,20
	3.6 4.2			10.88 02.94 10.91 02.94		10.0124-3202.3 340011	Hydraulik Verstärker
	3.6 4.2			10.88 02.94 10.91 02.94		03.2125-3610.3 010214	THz 25,40 ATE
	3.6 4.2			10.88 02.94 - (VBC) 10.91 02.94 - (VBC)		13.0460-2847.2 602847 24.8190-0105.2 620105	2 07.90- 21219 17,8 +/WE ATE Warnkontakt L=240mm
	3.6 4.2			10.88 02.94 10.91 02.94		83.7813-0252.3 330796	L=250
	3.6 4.2			10.88 02.94 10.91 02.94		24.3434-1702.5 240358 24.3434-1701.5 240357 11.0101-5403.2 260010	D=43, - Halter LUC D=43, - Halter LUC Fallenbalgsatz LUC
	3.6 4.2			10.88 02.94 10.91 02.94		13.0460-3602.2 603602	21144 15,8 /S LUC
	3.6 4.2			10.88 02.94 10.91 02.94		24.0120-0172.1 420172	269 19,9 18,0 V L
	3.6		4C-M-020000	10.88		24.5113-0220.3 331318	L=220
	3.6 4.2	4C-N-000001		02.94 02.94		24.5113-0209.3 331300	L=209
	3.6			10.88 02.94		03.2419-9610.3 030029	Gz 19,05
	3.6 4.2			10.88 02.94 10.91 02.94		03.2522-4300.3 040085	Nz 22,20
	1.0 1.3 1.3 Turbo			10.80 05.90 10.80 05.90 10.83 05.90		03.0137-0080.2 650080 03.0137-9200.2 669200	178 x 32 Bremsbacken-Zubehör AP AP
	0.85 1.0 1.0 1.0 HLE Mayfair 1.0 Mayfair Sport 1.1 Special 1.275 GT 1.3			10.67 08.79 10.67 09.84 01.92 06.93 08.82 06.93 09.88 06.93 10.76 08.81 10.69 08.80 + 12" Rad 1) 01.92 06.93		13.0460-6914.2 606914	20038 14,0 AP
	0.85 1.0 1.0 1.0 HLE Mayfair 1.0 Mayfair Sport 1.1 Special 1.275 GT			10.67 08.79 10.67 09.84 01.92 06.93 08.82 06.93 09.88 06.93 10.76 08.81 10.69 08.80		24.0110-0239.1 410239	214 9,6 8,6
	1.0 1.0 HLE Mayfair 1.1 Special			01.69 12.84 08.82 12.84 10.76 08.81		24.2723-1401.3 020342 24.2723-1402.3 020350	2 2 2 2 Rz 23,81 Rz 23,81

1) + 12" wheel / + ruota 12" / + roue 12" / + rueda 12"

									
AUSTIN MINI (67-93)									
	1.0 1.0 1.0 HLE Mayfair 1.0 Mayfair Sport 1.1 Special	30 31 30 33		10.67 01.92 08.82 09.88 10.76	09.84 06.93 06.93 06.93 08.81	24.3219-1401.3	020351	Rz 19,05	AP
	1.0 1.0 1.0 HLE Mayfair 1.0 Mayfair Sport 1.1 Special 1.3	30 31 30 33		10.67 01.92 08.82 09.88 10.76 01.92	09.84 06.93 06.93 06.93 08.81 06.93	03.0137-0080.2 03.0137-9205.2	650080 669205	178 x 32 Bremsbacken-Zubehör	AP AP
	1.0 1.0 1.0 HLE Mayfair 1.0 Mayfair Sport 1.1 Special 1.3	30 31 30 33		10.67 01.92 08.82 09.88 10.76 01.92	09.84 06.93 06.93 06.93 08.81 06.93	03.0420-2319.3	682319	19,05/178x32 Kit	AP
AUTO UNION AU 1000 (58-65)									
	1.0 1.0 S			04.58 08.59	06.65 03.64	03.3215-0221.3	020013	Rz 15,87	
AUTOBIANCHI A 111 (69-72)									
	1.4			08.69	11.72	13.0460-3936.2	603936	20073 17,3	BDX
	1.4			08.69	11.72	24.0111-0130.1	411130	227 10,8 9,0 +B	
	1.4			08.69	11.72	24.0111-0130.1	411130	227 10,8 9,0 +B	
AUTOBIANCHI A 112 (69-86)									
	0.9 1.0			10.69 11.77	12.85 12.85	24.2119-0806.3	010345	THz 19,05	
	0.9 1.0 1.0 Abarth			10.69 11.77 09.71	12.85 12.85 12.84	13.0460-3936.2	603936	20073 17,3	BDX
	0.9 1.0 1.0 Abarth			10.69 11.77 09.71	12.85 12.85 12.84	24.0111-0130.1	411130	227 10,8 9,0 +B	
	0.9 1.0 1.0 Abarth			10.69 11.77 09.71	10.82 10.82 10.82	24.3219-0801.3	020181	Rz 19,05	FI
	0.9 1.0 1.0 Abarth			11.82 11.82 11.82	12.85 12.84 12.84	24.3219-0803.3	020183	Rz 19,05	
	0.9 1.0 1.0 Abarth			10.69 11.77 09.71	12.85 12.85 12.84	03.0137-0015.2 03.0137-9021.2	650015 669021	185 x 31 AUT Bremsbacken-Zubehör	FI FI
	0.9 1.0 1.0 Abarth			10.69 11.77 09.71	12.85 12.85 12.84	24.0218-5001.1	480012	185/186,8 x 37	
	0.9 1.0 1.0 Abarth			11.82 11.82 11.82	12.85 12.84 12.84	03.0420-0319.3	680319	19,05/185x31 Kit	FI
AUTOBIANCHI GIADINIERA (60-78)									
	120 120 F			01.60 01.60	12.78 12.78	24.3219-0801.3	020181	Rz 19,05	FI
	120 120 F			01.60 01.60	12.78 12.78	24.3219-0801.3	020181	Rz 19,05	FI
AUTOBIANCHI Y 10 (85-95)									
	1.0 1.0 i.e. 1.1 i.e. 1.1 Turbo 1.3 GT i.e.			06.85 12.87 01.90 06.85 02.89	12.89 12.89 12.92 12.89 12.92	24.2120-0801.3	010362	THz 20,64	
	1.1 i.e. 1.3 GT i.e.			01.93 01.93	12.95 12.95	24.2120-1733.3	010686	THz 20,64	
	1.0 1.0 i.e. 1.1 i.e.			06.85 12.87 01.90	12.89 12.89 12.95	13.0460-3940.2 13.0460-0410.2	603940 610410	20775 18,0 /WK Belagsatz-Zubehör	BDX BDX
	1.1 Turbo 1.3 GT i.e.			06.85 02.89	12.89 12.95	13.0460-2941.2	602941	20839 17,0 /WK/S	LUC

AUTOBIANCHI Y 10 (85-95)													
	1.0 1.0 i.e. 1.1 i.e. 1.1 Turbo 1.3 GT i.e.			06.85 12.87 01.90 06.85 02.89	12.89 12.89 12.95 12.89 12.95			24.0111-0130.1 24.0112-0122.1	411130 412122			227 10,8 9,0 +B 240 12,0 10,8	
	1.0 1.0 i.e. 1.1 i.e. 1.1 Turbo 1.3 GT i.e.			06.85 12.87 01.90 06.85 02.89	12.89 12.89 12.95 12.89 12.95			24.3219-0803.3	020183			Rz 19,05	
	1.0 1.0 i.e. 1.1 i.e. 1.1 Turbo 1.3 GT i.e.			06.85 12.87 01.90 06.85 02.89	12.89 12.89 12.95 12.89 12.95			03.0137-0015.2 03.0137-0273.2 03.0137-9021.2	650015 650273 669021			185 x 31 AUT 185 x 31 AUT Bremsbacken-Zubehör	FI AP FI
	1.0 1.0 i.e. 1.1 i.e. 1.1 Turbo 1.3 GT i.e.			06.85 12.87 01.90 06.85 02.89	12.89 12.89 12.95 12.89 12.95			24.0218-5001.1	480012			185/186,8 x 37	
	1.0 1.0 i.e. 1.1 i.e. 1.1 Turbo 1.3 GT i.e.			06.85 12.87 01.90 06.85 02.89	12.89 12.89 12.95 12.89 12.95			03.0420-0319.3 03.0520-4319.3	680319 694319			19,05/185x31 Kit 19,05/185x31 TopKit	FI AP
	1.0 1.0 i.e. 1.1 i.e. 1.1 Turbo 1.3 GT i.e.			06.85 12.87 01.90 06.85 02.89	12.89 12.89 12.92 12.89 12.92			24.3727-0519.2	580519	1	↓	L=2385	
	1.0 4WD 1.0 i.e. 4WD 1.1 i.e. 4WD			06.85 12.87 01.90	12.89 12.89 12.95			24.3727-0503.2	580503	1	↓	L=2670	
	1.0 1.0 i.e. 1.1 i.e. 1.1 Turbo 1.3 GT i.e.			06.85 12.87 01.90 06.85 02.89	12.89 12.89 12.95 12.89 12.95			24.6513-0801.3	320117			BRL 1/3 (2)	
BMW Isetta													
	Isetta			01.60	12.62			83.6104-0360.3	330475	2		L=360	
	Isetta			01.60	12.62			03.3217-0301.3	020022		(03.3217-0302.3)	Rz 17,46	
	Isetta			01.60	12.62			83.6104-0360.3	330475			L=360	
BMW 1502 - 2002 (65-77)													
	1600 2 1600 2 ti 1600 Touring 1602 1800 Touring 1802 1802 Touring 2000 Touring 2002	1588671		01.69 12.71 01.71 01.71 01.71 01.71 01.73 01.69 01.69	12.71 + Bremsgerät 1) 12.71 12.73 12.75 12.73 12.75 12.75 12.71 12.75			03.2120-3412.3	010121			THz 20,64	ATE
	1800 2000 2000 tii 2002 ti/tii 2002 Turbo			01.69 01.69 01.69 01.69 01.73	12.71 12.71 12.75 12.75 12.75			03.2123-6802.3	010186			THz 23,81	ATE
	1502 1600 2 1600 2 ti 1600 Touring 1602 1800 Touring 1802 1802 Touring 2000 Touring 2002	55		01.75 01.69 01.67 01.71 01.71 01.71 01.73 01.69 01.69	12.77 12.71 12.71 12.73 12.75 12.73 12.75 12.71 12.75			03.3508-5851.3 03.3508-5951.3 03.3508-5959.3	310039 310041 310044		+ Kupplungsabgang 2) - Kupplungsabgang 3) - Kupplungsabgang 3)	Behälter Behälter Behälter + WE	
	1502 1600 2 1600 2 ti 1600 Touring 1602 1800 Touring 1802 1802 Touring 2000 Touring 2002	55		01.75 12.71 12.71 01.71 01.71 01.71 01.73 01.69 01.69	12.77 12.71 12.71 12.73 12.75 12.73 12.75 12.71 12.75			13.0441-4825.2	250107			Dichtungssatz	ATE
	1600 2 1600 2 ti 1600 Touring 1602 1800 Touring 1802 1802 Touring 2000 Touring 2002	1870200 1588671 1624531		12.71 12.71 01.71 01.71 01.71 01.71 01.73 01.69 12.75	12.71 12.71 12.73 12.75 12.73 12.75 12.73 12.75			13.4341-8002.2 13.4341-8001.2 13.0441-3401.2	210152 210151 250044			D=34 D=34 Dichtungssatz	ATE

1) + booster unit / + servofreno / + servo-frein / + servofreno
2) + outlet port for clutch / + potenz.in uscita lato frizi. / + sortie d'embrayage / + salida conexión embrague
3) - outlet port for clutch / - uscita per frizione / - sortie d'embrayage / - salida conexión embrague

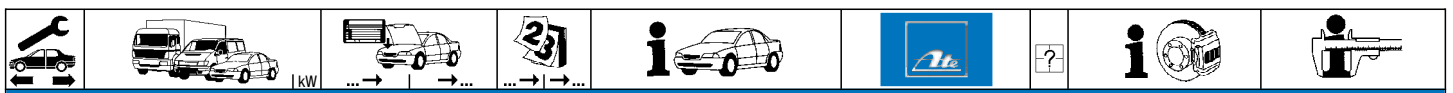

BMW 1502 - 2002 (65-77)

	1800 2000 2000 tii 2002 ti/tii 2002 Turbo		01.69 01.69 01.69 01.69 01.73	12.71 12.71 12.75 12.75 12.75	13.4401-8022.2 13.4401-8021.2 13.0441-4018.2	210190 210189 250083 250083		D=40 D=40 Dichtungssatz	ATE
	1502	55	01.75	12.77	13.0460-4033.2 13.0460-0038.2	604033 610038		20034 15,0 Belagsatz-Zubehör	ATE ATE
	1600 2 1600 2 ti 1600 Touring 1602 1800 Touring 1802 1802 Touring 2000 Touring 2002	1870200 1588671	01.71 01.71 01.71 01.71 01.71 01.73 01.69	12.71 12.71 12.73 12.75 12.73 12.75 12.73	13.0460-5029.2 13.0460-0018.2	605029 610018		20126 15,0 Belagsatz-Zubehör	ATE ATE
	1800 2000 2000 tii 2002 ti/tii 2002 Turbo		01.69 01.69 01.69 01.69 01.73	12.71 12.71 12.75 12.75 12.75	13.0460-9030.2	609030		20092 15,0	ATE
	1502 1600 2 1600 2 ti 1600 Touring 1602 1800 Touring 1802 1802 Touring 2000 Touring 2002	55 1870200 1588671	01.75 01.71 01.71 01.71 01.71 01.73 01.69	12.77 12.71 12.71 12.73 12.75 12.73 12.75 12.73	24.0110-0109.1	410109		240 10,0 8,4	
	1600 2 1600 2 ti 2000 2002		01.66 01.67 01.66 01.68	12.68 12.68 12.69 12.69	83.7704-0290.3	330826	2	L=290	
	1502 1600 2 1600 2 ti 1600 Touring 1602 1800 Touring 1802 1802 Touring 2000 Touring 2002	55	01.75 01.69 01.69 01.71 01.71 01.71 01.71 01.73 01.69 01.70	12.77 12.71 12.71 12.73 12.75 12.73 12.75 12.75 12.73 12.75	24.5201-0290.3	331401	4	L=290	
	1502 1600 2 1600 2 ti 1600 Touring 1602 1800 Touring 1802 1802 Touring 2000 Touring 2002	55	01.75 01.69 01.67 01.71 01.71 01.71 01.71 01.73 01.69 01.69	12.77 12.71 12.71 12.73 12.75 12.73 12.75 12.75 12.71 12.75	24.5201-0204.3	331400	2	L=204	
	1800 1800 ti 2000 2000 C/CA/CS 2000 ti/tiLux 2002 2002 ti 2002 ti/tii		01.69 01.65 01.65 01.65 01.66 01.68 01.69 01.69	12.71 12.71 12.71 12.71 12.71 12.71 12.75 12.75	03.3217-0602.3	020024		03.3518-0200.2 mitverwenden 1)	Rz 17,46
	1502 1600 2 ti 1800 Touring 1802 1802 Touring 2000 Touring 2002	55	01.75 01.67 01.71 01.71 01.73 01.69 01.68	12.77 12.71 12.73 12.75 12.75 12.73 12.75	24.3215-1105.3	020159		Rz 15,87	
	1600 2 1600 Touring 1602 2000 tii 2002 ti/tii		01.66 01.71 01.71 01.69 01.69	12.71 12.73 12.75 12.75 12.75	24.3217-1707.3	020108		Rz 17,46	
	2002 Turbo		01.73	12.75	03.3222-4211.3	020075		Rz 22,20	
	1800 2000		01.69 01.65	12.71 12.71	03.0137-0009.2	650009		250 x 42 HEB	
	1600 2 1600 Touring 1602		01.66 01.71 01.71	12.71 12.73 12.75	24.0220-0007.1	480015		200/201 x 45	
	1800 2000		01.69 01.65	12.71 12.71	24.0225-0001.1	480043		250/251 x 47	
	1502	55	01.75	12.77	24.0223-0005.1	480035		230/231 x 46,5	

1) 03.3518-0200.2 reuse / 03.3518-0200.2 riutilizzare / 03.3518-0200.2 utiliser / 03.3518-0200.2 emplear



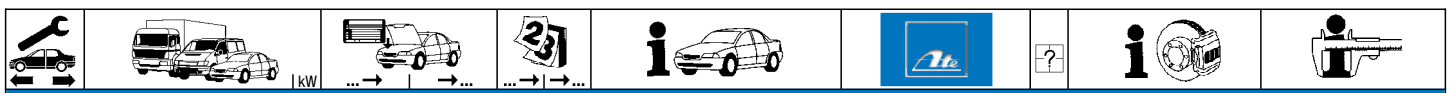

BMW 1502 - 2002 (65-77)

	1600 2 ti 1800 Touring 1802 1802 Touring 2000 Touring 2002			01.67 01.71 01.71 01.73 01.69 01.68	12.71 12.73 12.75 12.75 12.73 12.75		24.0223-0005.1	480035			230/231 x 46,5
	1502 1600 Touring 1602 1800 Touring 1802 2000 Touring 2002	55		01.75 01.71 01.71 01.71 01.69 01.69	12.77 12.73 12.75 12.73 12.71 12.75		24.3727-0202.2	580202	2 ↓		L=1528
	1502	55		01.75	12.77 + ⑤		03.6058-0501.3	320074			BR 25/5 (4) ATE
	1600 4 1800 1800 ti		931262 976908 985060	12.67 01.69 10.63			03.0350-1508.2 03.3304-0700.1	071508 390082			Gz Reparatursatz Behälterstopfen
	1502 1600 Touring 1602 1800 Touring 1802 1802 Touring 2002	55		01.75 01.71 01.71 01.71 01.71 01.73 01.69	12.77 12.73 12.75 12.73 12.75 12.75 12.75		03.2419-7800.3 03.0350-1919.2	030016 071919			Gz 19,05 Gz Reparatursatz
	1600 4 1800 1800 ti 2000 2000 C/CA/CS 2000 ti/tilux 2002 2002 ti		931263 976909 985061 1907278 1962744 1109264 1626693 1681795	12.75 01.65 01.65 01.66 01.69 01.69	12.75 12.71 12.71		03.2519-1402.3	040005			Nz 19,05
	1502 1600 Touring 1602 1800 1800 Touring 1802 1802 Touring 2000 2000 C/CA/CS 2002 2002 ti	55	1907279 1962745 1109265 1626694 1681796	01.75 01.71 01.71 01.71 01.71 01.73 12.71 12.71 12.75 12.75	12.77 12.73 12.75 12.71 12.75 12.75 12.71 12.71 12.75 12.75		03.2520-1001.3	040009			Nz 20,64
	1502 1600 4 1800 1800 ti 2000	55		01.75 01.65 01.69 01.65 01.65	07.77 12.75 12.71 12.75 12.71		24.5201-0204.3	331400			L=204

BMW 2000 (66-69)

	2000			01.66	12.69		13.0441-5406.2	250110			Dichtungssatz ATE
--	------	--	--	-------	-------	--	----------------	--------	--	--	--------------------------



















BMW 2,5/2,8/3,0/3,3 (68-77)





























	2.5 CS 2500 2800 3.0 CS 3.0 S/CS 3.0 S/LS/CS 2800 CS			01.74 01.69 01.69 01.71 01.71 01.71 01.70	12.77 12.77 12.77 12.72 + Automatikgetriebe 1) 12.72 + Schaltgetriebe 2) 12.72 12.72		03.2122-6202.3	010148			THz 22,20 ATE
	2.8 3.0 S/CS 3.0 S/LS/CS 3.3			01.75 01.73 01.73 01.74	12.77 12.77 12.77 + Automatikgetriebe 1) 12.77		03.2123-7002.3	010187			THz 23,81 ATE
	2.5 CS 2500 2800 3.0 S/LS/CS 3.3			01.74 01.69 01.69 01.71 01.74	12.77 12.77 12.77 12.77 12.77		03.3508-5959.3	310044		- Kupplungsabgang 3)	Behälter + WE
	2.5 CS 2500 2800			01.74 01.69 01.69	12.77 12.77 12.77		13.4401-8021.2 13.4401-8022.2 13.0441-4018.2	210189 210190 250083	<input type="checkbox"/> <input type="checkbox"/>		D=40 D=40 Dichtungssatz ATE
	2.8 3.0 S/LS/CS 3.3			01.75 01.71 01.74	12.77 12.77 12.77		13.0441-4018.2	250083			Dichtungssatz ATE
	2.5 CS 2500 2800 3.0 S/LS/CS 3.3			01.74 01.69 01.69 01.71 01.74	12.77 12.77 12.77 12.77 12.77		13.0460-9030.2	609030			20092 15,0 ATE

1) + autom.transmission / + scatola cambio automatico / + transmission automatique / + cambio automático

2) + manual transmission / + scatola cambio velocità / + transmission mécanique / + cambio de velocidad

3) - outlet port for clutch / - uscita per frizione / - sortie d'embrayage / - salida conexión embrague

	 kW									
BMW 2,5/2,8/3,0/3,3 (68-77)										
	2.5 CS 2500 2800 3.0 S/LS/CS 3.3			01.74 12.77 01.69 12.77 01.69 12.77 01.71 12.77 01.74 12.77		24.5201-0290.3	331401	4	L=290	
	2.5 CS 2500 2800			01.74 12.77 01.69 12.77 01.69 12.77		13.2421-8005.2 13.2421-8006.2 24.9242-8005.5 24.9242-8006.5 13.0441-4205.2	210053 210054 230027 230028 250086	<input type="checkbox"/> <input type="checkbox"/> <input type="checkbox"/> <input type="checkbox"/> <input type="checkbox"/>	D=42 D=42 D=42 D=42 Dichtungssatz	ATE ATE ATE ATE ATE
	2.8 3.0 S/LS/CS 3.3			01.75 12.77 01.71 12.77 01.74 12.77		24.9242-8007.5 24.9242-8008.5 13.0441-4205.2	230029 230030 250086	<input type="checkbox"/> <input type="checkbox"/> <input type="checkbox"/>	D=42 D=42 Dichtungssatz	ATE ATE ATE
	2.5 CS 2.8 3.0 S/CS 3.0 S/LS/CS 3.3			01.74 12.77 01.75 12.77 01.71 12.77 01.71 12.77 01.74 12.77		13.0460-3024.2	603024		20436 15,0 /WE	ATE
	2.8 2500 2800 3.0 S/LS 3.3			01.75 12.77 01.69 12.77 01.69 12.77 01.71 12.77 01.74 12.77		83.7704-0200.3 24.5201-0204.3	330825 331400	<input type="checkbox"/> <input type="checkbox"/>	L=200 L=204	
	2.5 CS 2800 CS 3.0 CS			01.74 12.77 01.70 12.72 01.71 12.77		24.5201-0204.3	331400	2	L=204	
	2800 CS			01.70 12.72		03.3222-4211.3	020075		Rz 22,20	
	2.5 CS 2500 2800 3.0 S/LS/CS 3.3			01.74 12.77 01.69 12.77 01.69 12.77 01.71 12.77 01.74 12.77		03.0137-0149.2	650149		160 x 25	
	2.5 CS 2500 2800 3.0 S/LS/CS 3.3	◀		01.74 05.75 01.69 05.75 01.69 05.75 01.71 05.75 01.74 05.75		03.0350-1919.2	071919		Gz Reparatursatz	
	2.5 CS 2500 2800 3.0 S/LS/CS 3.3	◀		06.75 12.77 06.75 12.77 06.75 12.77 06.75 12.77 06.75 12.77		03.0350-1919.2	071919		Gz Reparatursatz	
	2.5 CS 2500 2800 3.0 S/LS/CS 3.3	▶		01.74 12.77 01.69 12.77 01.69 12.77 01.71 12.77 01.74 12.77		03.0350-1919.2	071919		Gz Reparatursatz	
	2500 2800 3.0 S/LS/CS			01.69 08.73 01.69 08.73 01.71 08.73		03.2522-3001.3	040013		Nz 22,20	
	2.5 CS 2500 2800 3.0 S/LS/CS 3.3			09.73 12.77 09.73 12.77 09.73 12.77 09.73 12.77 09.73 12.77		03.2522-3601.3	040014		Nz 22,20	
BMW 3er Reihe/E21 (75-83)										
	315 316 318 318 i 320 i 320/4 320/6 323 i	◀		04.81 12.83 - (USA) 06.75 07.83 - (USA) 06.75 08.80 - (USA) 06.75 06.82 - (USA) 10.75 07.78 - (USA) 06.75 07.79 - (USA) 10.77 10.82 - (USA) 02.78 10.82 - (USA)		03.2120-0622.3	010079		Thz 20,64	ATE
	315 316 318 318 i 320 i 320/4 320/6 323 i	◀		04.81 12.83 + (USA) 06.75 07.83 + (USA) 06.75 08.80 + (USA) 06.75 06.82 + (USA) 10.75 09.82 + (USA) 06.75 07.79 + (USA) 10.77 10.82 + (USA) 02.78 10.82 + (USA)		03.2120-1362.3	010087		Thz 20,64	ATE
	315 316 318 i 320 i 320/4 320/6 323 i	▶		04.81 12.82 08.77 07.83 01.80 06.82 08.77 07.78 08.77 07.79 10.77 10.82 02.78 10.82		03.2120-0562.3	010078		Thz 20,64	ATE

											
BMW 3er Reihe/E21 (75-83)											
	316 320 i 320/4			11.75 11.75 11.75	07.77 07.77 07.77	+ Schaltgetriebe ¹⁾ + Schaltgetriebe ¹⁾ + Schaltgetriebe ¹⁾	03.3508-5851.3	310039	Behälter		
	316 320 i 320/4			11.75 11.75 11.75	07.77 07.77 07.77	+ Automatikgetriebe ²⁾ + Automatikgetriebe ²⁾ + Automatikgetriebe ²⁾	03.3508-5951.3	310041	Behälter		
	315 316 318 318 i 320 i 320/4 320/6			04.81 06.75 06.75 09.79 09.78 06.75 08.77	12.83 07.83 08.80 12.83 09.82 07.79 10.82	+ 	13.2481-8011.2 13.2481-8012.2 13.0441-4825.2	210092 210093 250107	D=48 D=48 Dichtungssatz	ATE ATE ATE	
	320 i 323 i			10.75 01.78	07.78 10.82		13.0441-4825.2	250107	Dichtungssatz	ATE	
	315 316 318 318 i 320 i 320/4 320/6			04.81 06.75 06.75 09.79 09.78 06.75 08.77	12.83 07.83 08.80 12.83 09.82 07.79 10.82	+ 	13.0460-5032.2 13.0460-0916.2 24.8190-0215.2	605032 610916 620215	20588 16,5 /WE Belagsatz-Zubehör Warnkontakt L=162mm	ATE LUC	
	320 i 323 i			10.75 01.78	07.78 10.82		13.0460-5032.2 13.0460-0916.2 24.8190-0215.2	605032 610916 620215	20588 16,5 /WE Belagsatz-Zubehör Warnkontakt L=162mm	ATE LUC	
	315 316 318 318 i 320 i 320/4 320/6			04.81 06.75 06.75 09.79 09.78 06.75 08.77	12.83 07.83 08.80 12.83 09.82 07.79 10.82	+ 	24.0113-0138.1	413138	255 12,7 11,1		
	320 i 323 i			10.75 01.78	07.78 10.82		24.0122-0112.1	422112	255 22,0 20,4 V		
	315 316 318 318 i 320 i 320/4 320/6 323 i			04.81 06.75 06.75 06.75 10.75 06.75 10.77 02.78 01.78	12.83 07.83 08.80 06.82 07.78 07.79 10.82 10.82		24.5201-0290.3	331401	L=290		
	323 i			01.78	10.82		13.0460-0121.2 24.8190-0215.2	610121 620215	1	Belagsatz-Zubehör Warnkontakt L=162mm	ATE
	323 i			01.78	10.82		24.0110-0150.1	410150		258 10,0 8,4 +B	
	315 316 318 318 i 320 i 320/4 320/6 323 i			04.81 06.75 06.75 09.79 09.78 10.75 06.75 08.77 01.78	12.83 07.83 08.80 12.83 09.82 07.78 07.79 10.82 10.82	+ 	83.7704-0200.3 24.5201-0204.3	330825 331400		L=200 L=204	
	323 i			01.78	10.82		83.7704-0200.3 24.5201-0204.3	330825 331400		L=200 L=204	
	315 316 318 318 i 320 i 320/4 320/6			04.81 06.75 06.75 09.79 09.78 10.75 06.75 08.77	12.83 07.83 08.80 12.83 09.82 07.78 07.79 10.82	- (S) - (S) - (S) + (USA) - (S) - (S) - (S)	03.3219-2106.3	020043		Rz 19,05	
	315 316 318 318 i 320 i 320/4 320/6			04.81 06.75 06.75 09.79 09.78 10.75 06.75 08.77	12.83 07.83 08.80 12.83 09.82 07.78 07.79 10.82	+ 	03.0137-0009.2	650009		250 x 42 HEB	
	315 316 318 318 i 320 i 320/4 320/6			04.81 06.75 06.75 09.79 09.78 10.75 06.75 08.77	12.83 07.83 08.80 12.83 09.82 07.78 07.79 10.82	+ 	24.0225-0001.1	480043		250/251 x 47	



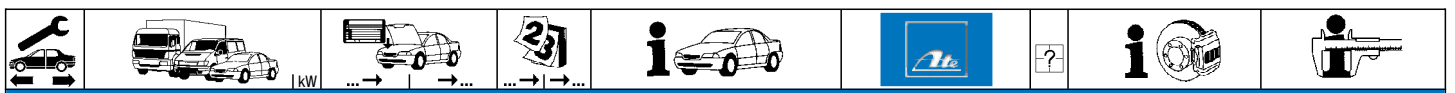















¹⁾ + manual transmission / + scatola cambio velocità / + transmission mécanique / + cambio de velocidad
²⁾ + autom.transmission / + scatola cambio automatico / + transmission automatique / + cambio automático











BMW 3er Reihe/E21 (75-83)										
	323 i			01.78	10.82		03.0137-0149.2 03.0137-9058.2	650149 669058		160 x 25 Bremsbacken-Zubehör
	315 316 318 318 i 320 i 320 i 320/4 320/6			04.81 06.75 06.75 09.79 09.78 10.75 06.75 08.77	12.83 07.83 08.80 12.83 09.82 + USA 07.78 07.79 10.82		24.3727-0201.2	580201	2 ↓	L=1632
	323 i			01.78	10.82		24.3727-0206.2	580206	2 ↓	L=1616
	316 318 320 i 320/4 320/6			06.75 06.75 10.75 06.75 08.77	07.79 07.79 07.78 07.79 07.79		03.6058-0501.3	320074		BR 25/5 (4) ATE
	315 316 318 318 i 320 i 320/4 320/6 323 i	← ← ← ← ← ← ← ←		04.81 06.75 06.75 06.75 10.75 06.75 10.77 02.78	12.83 07.83 08.80 06.82 07.78 07.79 10.82 10.82		03.2419-9000.3 03.0350-1919.2	030025 071919		Gz 19,05 Gz Reparatursatz
	315 316 318 318 i 320 i 320/4 320/6 323 i			04.81 06.75 06.75 06.75 10.75 06.75 10.77 02.78	12.83 07.83 08.80 06.82 07.78 07.79 10.82 10.82		03.2520-1201.3 03.0450-2006.2	040011 082006		Nz 20,64 Nz Reparatursatz

BMW 3er Reihe/E30 (82-93)										
	316 316 i 316 i Touring 318 i 318 i Cabrio 318 i Touring 318 iS 320 i 320 i Cabrio 320 i Touring 320 iS 323 i 324 d 324 td 324 td Touring 325 e 325 i 325 i Cabrio 325 i Touring 325 iX	66 95 85		03.82 07.87 06.91 03.82 07.90 09.87 02.89 01.82 04.86 01.88 09.87 09.82 04.85 02.87 01.88 10.83 09.83 07.85 07.87 03.86	07.88 12.91 06.94 12.91 05.93 06.94 12.91 12.91 12.92 09.93 12.91 09.86 12.91 12.91 09.93 09.87 12.91 12.92 09.93 11.87		03.7760-0902.4	300088		10" ATE
	316 316 318 i 318 i 320 i 320 i 324 d	← 66 ▶ 66 ← ▶ ▶ ▶		03.82 03.82 03.82 01.82 01.82 04.85	04.87 06.86 04.87 06.86 04.87 06.86 04.87 - ABS		03.2020-0402.3	010001		THz 20,64/19,05 ATE
	316 318 i 318 i 320 i 323 i 323 i 325 e 325 i 325 i Cabrio	▶ 66 ▶ ▶ ▶ ▶ ▶		07.86 07.86 03.82 07.86 09.82 07.86 10.83 09.83 07.85	04.87 04.87 04.87 04.87 09.86 09.86 04.87 08.86 09.86 - ABS - ABS - ABS - ABS		03.2120-2082.3	010107		THz 20,64 ATE
	316 318 i 320 i 323 i 324 d 325 i 325 i Cabrio 325 iX	66		03.82 03.82 01.82 09.82 04.85 09.86 07.85 03.86	04.87 04.87 04.87 09.86 04.87 04.87 04.87 + ABS + ABS + ABS + ABS		03.2120-1802.3	010099		THz 20,64 ATE
	316 316 i 316 i Touring 318 i 318 i Cabrio 318 i Touring 318 iS	66		05.87 07.87 06.91 05.87 07.90 09.87 02.89	07.88 12.91 06.94 12.91 06.94 09.93 12.91		03.2022-1201.3	010009		THz 22,20/17,46 ATE



										
BMW 3er Reihe/E30 (82-93)										
	320 i 320 i Cabrio 320 i Touring 320 iS 324 d 324 td 324 td Touring 325 e 325 i 325 i Cabrio 325 i Touring 325 iX	95 85		05.87 04.86 01.88 09.87 05.87 02.87 01.88 05.87 05.87 05.87 07.87 09.86	12.91 12.92 09.93 12.91 12.91 12.91 09.93 09.87 12.91 12.92 09.93 10.87			03.2022-1201.3 010009	THz 22,20/17,46 ATE	
	316 318 i 318 iS 320 i 320 i Cabrio 320 i Touring 320 iS 324 d 324 td 324 td Touring 325 e 325 i 325 i Cabrio 325 i Touring	66 95 85		07.87 03.82 02.89 01.82 04.86 01.88 09.87 04.85 02.87 01.88 10.83 09.83 07.85 07.87	07.88 12.91 12.91 12.91 12.92 09.93 12.91 12.91 09.93 09.87 12.91 12.92 09.93	+ Behörde ¹⁾ + Behörde ¹⁾		11.0441-4810.2 11.0101-5402.2 11.8171-0008.1 250023 260009 990049 24.3481-1607.5 24.3481-1608.5 11.0441-4810.2 11.0101-5402.2 11.8171-0008.1 240211 240212 250023 260009 990049	Dichtungssatz Hülssensatz Führungsbolzen D=48, - Halter D=48, - Halter Dichtungssatz Hülssensatz Führungsbolzen	ATE ATE ATE LUC LUC ATE ATE ATE
	316 316 i 316 i Touring 318 i 318 i Cabrio 318 i Touring 323 i 325 iX 325 iX Touring M3 M3 Cabrio	66		03.82 07.87 06.91 03.82 07.90 09.87 09.82 03.86 03.88 07.86 06.88	07.88 12.91 06.94 12.91 05.93 06.94 09.86 12.91 09.93 12.91 09.92	+ ABS + ABS/ + Behörde ²⁾ + ABS/ + Behörde/ +  ³⁾		24.3481-1607.5 24.3481-1608.5 11.0441-5402.2 11.0101-5402.2 11.8171-0008.1 11.8116-0091.1 250028 260009 990049 390502	D=48, - Halter D=48, - Halter	LUC LUC ATE ATE ATE
	316 316 i 316 i Touring 318 i 318 i Cabrio 318 i Touring 318 iS 320 i 320 i Cabrio 320 i Touring 320 iS 323 i 324 d 324 td 324 td Touring 325 e 325 i 325 i Cabrio 325 i Touring 325 iX 325 iX Touring M3 M3 Cabrio	66 95 85		03.82 07.87 06.91 03.82 07.90 09.87 02.89 01.82 04.86 01.88 09.87 09.82 04.85 02.87 01.88 10.83 09.83 07.87 03.86 03.88 07.86 06.88	07.88 12.91 06.94 12.91 05.93 06.94 12.91 12.91 12.92 09.93 09.93 09.86 12.91 12.91 09.93 09.87 12.91 12.92 09.93 12.91 09.93 12.91 09.92			13.0460-2921.2 24.8190-0201.2 13.0460-7046.2 24.8190-0213.2 602921 620201 607046 620213	21173 17,0 /WE/S Warnkontakt L=235mm	LUC ATE
	316 316 i 318 i 316 316 i 316 i Touring 318 i 318 i Cabrio 318 i Touring 318 iS 320 i 320 i Cabrio 320 i Touring 320 iS 323 i 324 d 324 td 324 td Touring 325 e 325 i 325 i Cabrio 325 i Touring 325 iX 325 iX	66 66 85		03.82 07.87 03.82 03.82 07.87 06.91 03.82 07.90 09.87 02.89 01.82 04.86 01.88 09.87 09.82 04.85 02.87 01.88 10.83 09.83 07.87 03.86	07.88 12.91 12.91 12.91 12.91 06.94 12.91 05.93 06.94 12.91 12.91 12.92 09.93 09.86 12.91 12.91 09.93 09.87 12.91 12.92 09.93 12.91	- ABS - ABS/ - Behörde ⁴⁾ - ABS/ - Behörde/ -  ⁵⁾ + ABS + ABS/ + Behörde ²⁾ + ABS/ + Behörde/ +  ³⁾ +  + 		24.0113-0167.1 24.0122-0122.1 24.0322-0122.1 413167 422122 522122	260 12,7 11,1 +B 260 22,0 20,4 V L +B 260 22,0 19,6 V L +B PD	

¹⁾ + authority cars / + enti statali / + véhicule communal / + vehiculos oficiales
²⁾ + ABS/ + authority cars / + ABS/ + enti statali / + ABS/ + véhicule communal / + ABS/ + vehiculos oficiales
³⁾ + ABS/ + authority cars/ +  / + ABS/ + enti statali/ +  / + ABS/ + veh.communal/ +  / + ABS/ + veh.oficiales/ + 
⁴⁾ - ABS/ - authority cars / - ABS/ - enti statali / - ABS/ - véhicule communal / - ABS/ - vehiculos oficiales
⁵⁾ - ABS/ - authority cars/ -  / - ABS/ - enti statali/ -  / - ABS/ - veh.communal/ -  / - ABS/ - veh.oficiales/ - 



BMW 3er Reihe/E30 (82-93)										
	325 iX Touring		03.88	09.93		24.0122-0122.1	422122			260 22,0 20,4 VL +B
						24.0322-0122.1	522122			260 22,0 19,6 VL +B PD
	316	66	03.82	07.88		24.5102-0304.3	331407	2		L=304
	316 i		07.87	12.91						
	316 i Touring		06.91	06.94						
	318 i		03.82	12.91						
	318 i Cabrio		07.90	05.93						
	318 i Touring		09.87	06.94						
	318 iS		02.89	12.91						
	320 i		01.82	12.91						
	320 i Cabrio		04.86	12.92						
	320 i Touring	95	01.88	09.93						
	320 iS		09.87	12.91	+ I P					
	323 i		09.82	09.86						
	324 d		04.85	12.91						
	324 td		02.87	12.91						
	324 td Touring	85	01.88	09.93						
	325 e		10.83	09.87						
	325 i		09.83	12.91						
	325 i Cabrio		07.85	12.92						
	325 i Touring		07.87	09.93						
	M3		07.86	12.91						
	M3 Cabrio		06.88	09.92						
	325 iX		02.85	12.91		83.6124-0331.3	330267	2		L=330
	325 iX Touring		03.88	09.93						
	316	66	03.82	07.88	+ ABS	11.3331-8501.2	220004			D=33, - Halter
	316 i		07.87	12.91	+ ABS/ + Behörde ¹⁾	11.3331-8502.2	220005			D=33, - Halter
	318 i		03.82	12.91	+ ABS/ + Behörde/ + ABS ²⁾	24.3331-8501.5	240509			D=33, - Halter
	318 iS		02.89	12.91	+ Behörde ³⁾	24.3331-8502.5	240510			D=33, - Halter
	320 i		01.82	12.91	+ ABS	11.0441-3302.2	250004			Dichtungssatz
	320 i		09.87	12.91	+ Behörde ³⁾	11.0101-5402.2	260009			Hülssensatz
	320 i Cabrio		04.86	12.92		11.8171-0008.1	990049			Führungsbolzen
	320 iS		09.87	12.91	+ I P	11.8116-0015.1	390492	2		Haltefeder
	323 i		09.82	09.86						
	324 d		04.85	12.91	+ ABS/ + Behörde ¹⁾					
	324 td		02.87	12.91						
	325 e		10.83	09.87						
	325 i		09.83	12.91						
	325 i Cabrio		07.85	12.92						
	325 iX		03.86	12.91						
	316 i Touring		06.91	06.94		11.0101-5402.2	260009			Hülssensatz
	318 i Cabrio		07.90	05.93		11.8171-0008.1	990049			Führungsbolzen
	318 i Touring		09.87	06.94		11.8116-0015.1	390492	2		Haltefeder
	320 i Touring	95	01.88	09.93						
	324 td Touring	85	01.88	09.93						
	325 i Touring		07.87	09.93						
	325 iX Touring		03.88	09.93		11.0101-5402.2	260009			Hülssensatz
						11.8171-0008.1	990049			Führungsbolzen
						11.8116-0015.1	390492	2		Haltefeder
	M3		07.86	12.91		11.3381-8501.2	220018			D=38, - Halter
	M3 Cabrio		06.88	09.92		11.0441-3802.2	250009			Dichtungssatz
						11.0101-5402.2	260009			Hülssensatz
						11.8171-0008.1	990049			Führungsbolzen
						11.8116-0066.1	390577	2		Haltefeder
	316	66	03.82	07.88	+ ABS	13.0460-7036.2	607036			20675 16,5 +/-WE
	316 i		07.87	12.91	+ ABS/ + Behörde ¹⁾	24.8190-0213.2	620213	1		Warnkontakt L=262mm
	316 i Touring		06.91	06.94						
	318 i		03.82	12.91	+ ABS/ + Behörde/ + ABS ²⁾					
	318 i Cabrio		07.90	05.93						
	318 i Touring		09.87	06.94						
	318 iS		02.89	12.91						
	320 i		01.82	12.91	+ ABS					
	320 i		09.87	12.91	+ Behörde ³⁾					
	320 i Cabrio		04.86	12.92						
	320 i Touring	95	01.88	09.93						
	320 iS		09.87	12.91	+ I P					
	323 i		09.82	09.86						
	324 d		04.85	12.91	+ ABS/ + Behörde ¹⁾					
	324 td		02.87	12.91						
	324 td Touring	85	01.88	09.93						
	325 e		10.83	09.87						
	325 i		09.83	12.91						
	325 i Cabrio		07.85	12.92						
	325 i Touring		07.87	09.93						
	325 iX		03.86	12.91						
	325 iX Touring		03.88	09.93						
	M3		07.86	12.91		13.0460-3803.2	603803			20995 17,3 +/-WE
	M3 Cabrio		06.88	09.92		24.8190-0213.2	620213	1		Warnkontakt L=262mm
	316	66	03.82	07.88	+ ABS	24.0110-0150.1	410150			258 10,0 8,4 +B
	316 i		07.87	12.91	+ ABS/ + Behörde ¹⁾	24.0310-0150.1	510150			258 10,0 7,6 +B PD
	316 i Touring		06.91	06.94						
	318 i		03.82	12.91	+ ABS/ + Behörde/ + ABS ²⁾					
	318 i Cabrio		07.90	05.93						
	318 i Touring		09.87	06.94						
	318 iS		02.89	12.91						

1) + ABS/ + authority cars / + ABS/ + enti statali / + ABS/ + véhicule communal / + ABS/ + vehiculos oficiales
2) + ABS/ + authority cars/+ ABS / + ABS/ + enti statali/ + ABS / + ABS/ + veh.communal/ + ABS / + ABS/ + veh.oficiales/ + ABS
3) + authority cars / + enti statali / + véhicule communal / + vehiculos oficiales



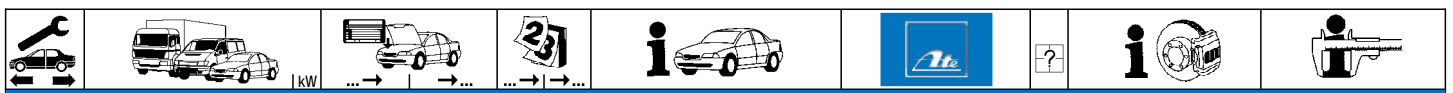

BMW 3er Reihe/E30 (82-93)

	320 i		01.82	12.91	+ ABS	24.0110-0150.1	410150			258 10,0 8,4 +B
	320 i		09.87	12.91	+ Behörde 1)	24.0310-0150.1	510150			258 10,0 7,6 +B PD
	320 i Cabrio		04.86	12.92						
	320 i Touring	95	01.88	09.93						
	320 iS		09.87	12.91	+ (L) (P)					
	323 i		09.82	09.86						
	324 d		04.85	12.91	+ ABS/ + Behörde 2)					
	324 td		02.87	12.91						
	324 td Touring	85	01.88	09.93						
	325 e		10.83	09.87						
	325 i		09.83	12.91						
325 i Cabrio		07.85	12.92							
325 i Touring		07.87	09.93							
325 iX		03.86	12.91		24.0110-0263.1	410263			258 10,0 8,4	
	316	66	03.82	07.88	- ABS	24.5201-0204.3	331400	2		L=204
	316 i		07.87	12.91	- ABS/ - Behörde 3)					
	318 i		03.82	12.91	- ABS/ - Behörde/ - (ABS) 4)					
	320 i		01.82	12.91	- ABS/ - Behörde 3)					
	324 d		04.85	12.91	- ABS/ - Behörde 3)					
	316	66	03.82	07.88	+ ABS	24.5201-0204.3	331400	2		L=204
	316 i		07.87	12.91	+ ABS/ + Behörde 2)	83.7704-0200.3	330825	2	am Bremsattel 5)	L=200
	316 i Touring		06.91	06.94						
	318 i		03.82	12.91	+ ABS/ + Behörde/ + (ABS) 6)					
	318 i Cabrio		07.90	05.93						
	318 i Touring		09.87	06.94						
318 iS		02.89	12.91							
320 i		01.82	12.91	+ ABS						
320 i		09.87	12.91	+ Behörde 1)						
320 i Cabrio		04.86	12.92							
320 i Touring	95	01.88	09.93							
320 iS		09.87	12.91	+ (L) (P)						
323 i		09.82	09.86							
324 d		04.85	12.91	+ ABS/ + Behörde 2)						
324 td		02.87	12.91							
324 td Touring	85	01.88	09.93							
325 e		10.83	09.87							
325 i		09.83	12.91							
325 i Cabrio		07.85	12.92							
325 i Touring		07.87	09.93							
325 iX		03.86	12.91							
325 iX Touring		03.88	09.93							
M3		07.86	12.91							
M3 Cabrio		06.88	09.92							
	316	66	03.82	08.86	- ABS	03.3220-3201.3	020065			Rz 20,64 LUC
	318 i		03.82	08.86	- ABS/ - Behörde/ - (ABS) 4)					
	320 i		01.82	12.91	- ABS/ - Behörde 3)					
	316	66	09.86	07.88	- ABS	24.3222-1604.3	020276			Rz 22,20 LUC
	316 i		07.87	12.91	- ABS/ - Behörde 3)					
	318 i		09.86	12.91	- ABS/ - Behörde/ - (ABS) 4)					
	324 d		04.85	12.91	- ABS/ - Behörde 3)					
	316	66	03.82	07.88	- ABS	03.0137-0151.2	650151			229 x 42 HEB LUC
	316 i		07.87	12.91	- ABS/ - Behörde 3)	03.0137-9076.2	669076			Bremsbacken-Zubehör LUC
	318 i		03.82	12.91	- ABS/ - Behörde/ - (ABS) 4)					
	320 i		01.82	12.91	- ABS/ - Behörde 3)					
	324 d		04.85	12.91	- ABS/ - Behörde 3)					
	316	66	03.82	07.88	- ABS	24.0222-8009.1	480026			229/229,5 x 46,4
	316 i		07.87	12.91	- ABS/ - Behörde 3)					
	318 i		03.82	12.91	- ABS/ - Behörde/ - (ABS) 4)					
	320 i		01.82	12.91	- ABS/ - Behörde 3)					
	316	66	03.82	08.86	- ABS	03.0420-0320.3	680320			20,64/229x42 Kit LUC
	318 i		03.82	08.86	- ABS/ - Behörde/ - (ABS) 4)					
	320 i		01.82	12.91	- ABS/ - Behörde 3)					
	316	66	09.86	07.88	- ABS	03.0420-2822.3	682822			22,20/229x42 Kit LUC
	316 i		07.87	12.91	- ABS/ - Behörde 3)					
	318 i		09.86	12.91	- ABS/ - Behörde/ - (ABS) 4)					
	324 d		04.85	12.91	- ABS/ - Behörde 3)					
	316	66	03.82	07.88	+ ABS	03.0137-0149.2	650149			160 x 25
	316 i		07.87	12.91	+ ABS/ + Behörde 2)	03.0137-9058.2	669058			Bremsbacken-Zubehör
	316 i Touring		06.91	06.94						
	318 i		03.82	12.91	+ ABS/ + Behörde/ + (ABS) 6)					
	318 i Cabrio		07.90	05.93						
	318 i Touring		09.87	06.94						
	318 iS		02.89	12.91						
	320 i		01.82	12.91	+ ABS					
	320 i		09.87	12.91	+ Behörde 1)					
	320 i Cabrio		04.86	12.92						
	320 i Touring	95	01.88	09.93						
	320 iS		09.87	12.91	+ (L) (P)					
	323 i		09.82	09.86						
	324 d		04.85	12.91	+ ABS/ + Behörde 2)					
	324 td		02.87	12.91						
324 td Touring	85	01.88	09.93							
325 e		10.83	09.87							
325 i		09.83	12.91							
325 i Cabrio		07.85	12.92							

1) + authority cars / + enti statali / + véhicule communal / + vehiculos oficiales

2) + ABS/ + authority cars / + ABS/ + enti statali / + ABS/ + véhicule communal / + ABS/ + vehiculos oficiales

3) - ABS/ - authority cars / - ABS/ - enti statali / - ABS/ - véhicule communal / - ABS/ - vehiculos oficiales

4) - ABS/ - authority cars/ - (ABS) / - ABS/ - enti statali/ - (ABS) / - ABS/ - veh.communal/ - (ABS) / - ABS/ - veh.oficiales/ - (ABS)

5) on the brake caliper / sulla pinza freno / sur l'étrier de frein / a la pinza de freno

6) + ABS/ + authority cars/ + (ABS) / + ABS/ + enti statali/ + (ABS) / + ABS/ + veh.communal/ + (ABS) / + ABS/ + veh.oficiales/ + (ABS)

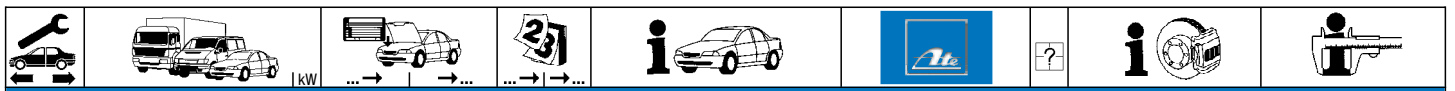

BMW 3er Reihe/E30 (82-93)

			07.87	09.93		03.0137-0149.2	650149		160 x 25
			02.85	12.91		03.0137-9058.2	669058		Bremsbacken-Zubehör
			03.88	09.93					
			07.86	12.91					
			06.88	09.92					
			03.82	07.88	- ABS	24.3727-0212.2	580212	2 ↓	L=1830
	66		07.87	12.91	- ABS/ - Behörde ¹⁾				
			03.82	12.91	- ABS/ - Behörde/ -				
			01.82	12.91	- ABS/ - Behörde ¹⁾				
			04.85	12.91	- ABS/ - Behörde ¹⁾				
		66	03.82	07.88	+ ABS	24.3727-0213.2	580213	2 ↓	L=1725
			07.87	12.91	+ ABS/ + Behörde ³⁾				
			06.91	06.94					
			03.82	12.91	+ ABS/ + Behörde/ +				
			07.90	05.93					
			09.87	06.94					
			02.89	12.91					
			01.82	12.91	+ ABS				
			09.87	12.91	+ Behörde ⁵⁾				
			04.86	12.92					
	95		01.88	09.93					
			09.87	12.91	+				
			09.82	09.86	+				
			04.85	12.91	+ ABS/ + Behörde ³⁾				
			02.87	12.91					
		85	01.88	09.93					
			10.83	09.87					
			09.83	12.91					
			07.85	12.92					
			07.87	09.93					
			03.86	12.91					
			03.88	09.93					
			07.86	12.91					
			06.88	09.92					
		66	03.82	04.87		03.6055-0303.3	320064		BR 25/5 (4) ATE
			03.82	04.87					
			01.82	04.87					
			04.86	04.87					
			09.82	09.86					
			04.85	04.87					
			02.87	04.87					
			10.83	04.87					
			09.83	04.87					
			07.85	04.87					
			03.86	04.87					
			07.86	04.87					
		66	05.87	07.88		03.6045-0620.3	320040		BRE 5/25 ATE
			07.87	12.91					
			05.87	12.91					
			07.90	05.93					
			02.89	12.91					
			05.87	12.91					
			05.87	12.92					
	95		01.88	09.93					
			09.87	12.91	+				
			05.87	12.91	+				
			05.87	12.91					
			01.88	09.93					
		85	05.87	09.87					
			05.87	12.91					
			05.87	12.92					
			07.87	09.93					
			05.87	12.91					
			03.88	09.93					
			05.87	12.91					
			06.88	09.92					
		66	03.82	07.88		24.2419-0912.3	030044		Gz 19,05
			07.87	12.91					
			06.91	06.94					
			03.82	12.91					
			07.90	05.93					
			09.87	06.94					
			02.89	12.91					
			01.82	12.91					
			04.86	12.92					
	95		01.88	09.93					
			09.87	12.91	+				
			09.82	09.86	+				
			04.85	12.91					
			02.87	12.91					
		85	01.88	09.93					
			10.83	09.87					
			09.83	12.91					
			07.85	12.92					
			07.87	09.93					
			03.86	12.91					
			03.88	09.93					
			03.88	09.93					

¹⁾ - ABS/ - authority cars / - ABS/ - enti statali / - ABS/ - véhicule communal / - ABS/ - vehiculos oficiales
²⁾ - ABS/ - authority cars/ - / - ABS/ - enti statali/ - / - ABS/ - veh.communal/ - / - ABS/ - veh.oficiales/ -
³⁾ + ABS/ + authority cars / + ABS/ + enti statali / + ABS/ + véhicule communal / + ABS/ + vehiculos oficiales
⁴⁾ + ABS/ + authority cars/ + / + ABS/ + enti statali/ + / + ABS/ + veh.communal/ + / + ABS/ + veh.oficiales/ +
⁵⁾ + authority cars / + enti statali / + véhicule communal / + vehiculos oficiales



BMW 3er Reihe/E30 (82-93)													
	M3 M3 Cabrio			07.86 06.88	12.91 09.92			24.2419-0912.3	030044				Gz 19,05
	316 316 i 316 i Touring 318 i 318 i Cabrio 318 i Touring 318 iS 320 i 320 i Cabrio 320 i Touring 320 iS 323 i 324 td 324 td Touring 325 e 325 i 325 i Cabrio 325 i Touring 325 iX 325 iX Touring M3 M3 Cabrio 324 d	66 95 85		03.82 07.87 06.91 03.82 07.90 09.87 02.89 01.82 04.86 01.88 09.87 09.82 02.87 01.88 10.83 09.83 07.85 07.87 03.86 03.88 07.86 06.88 04.85	07.88 12.91 06.94 12.91 05.93 06.94 12.91 12.91 12.92 09.93 09.86 12.91 09.93 09.93 09.87 12.91 12.92 09.93 12.91 09.93 12.91 09.92 12.91			03.2520-1201.3 03.0450-2006.2	040011 082006				Nz 20,64 Nz Reparatursatz
	316 316 i 316 i Touring 318 i 318 i Cabrio 318 i Touring 318 iS 320 i 320 i Cabrio 320 i Touring 320 iS 323 i 324 d 324 td 324 td Touring 325 e 325 i 325 i Cabrio 325 i Touring M3 M3 Cabrio 324 d	66 95 85		03.82 07.87 06.91 03.82 07.90 09.87 02.89 01.82 04.86 01.88 09.87 09.82 02.87 01.88 10.83 09.83 07.85 07.87 03.86 03.88 07.86 06.88 04.85	07.88 12.91 06.94 12.91 05.93 06.94 12.91 12.91 12.92 09.93 09.86 12.91 09.93 09.93 09.87 12.91 12.92 09.93 12.91 09.93 12.91 09.92 12.91			24.5802-0320.3	330050		+ Rohrleitung 1)	L=320	
BMW 5er Reihe/E12 (72-81)													
	518 520 4 520 6 520 i 525 528 525 528 528 i M 535 i	85 90		06.74 06.72 08.77 10.72 10.73 01.75 10.73 01.75 03.77 04.80	09.78 01.79 04.79 07.79 06.81 07.77 06.81 07.77 06.81 05.81			03.2123-6802.3	010186				THz 23,81 ATE
	518 518 i 520 4 520 6 520 i 525 528 528 i	85 90		06.74 09.79 06.72 08.77 10.72 10.73 01.75 03.77	05.81 06.81 01.79 06.81 07.79 06.81 07.77 06.81	+ Automatikgetriebe 2) + Schaltgetriebe 3) + Automatikgetriebe 2) + Automatikgetriebe 2)		03.3508-8801.3 03.3508-8802.3	310050 310051			im Motorraum 4) im Motorraum 4)	Behälter Behälter + WE
	518 520 4 520 i 525 528 518 518 i 520 4 520 6 520 i 525 518 520 4 520 6 520 i 525	85 85 90		06.74 06.72 10.72 10.73 01.75 08.76 09.79 08.76 08.77 08.76 06.76 08.76 08.76 08.76 08.76 03.77	07.76 07.76 07.76 07.76 07.76 05.81 06.81 01.79 06.81 07.79 06.81 06.81 05.81 01.79 06.81 07.79 06.81 07.77 06.81			13.4401-8021.2 13.4401-8022.2 13.0441-4018.2	210189 210190 250083			D=40 D=40 Dichtungssatz	ATE
	518 518 i 520 4 520 6 520 i 525	85 		08.76 09.79 08.76 08.77 08.76 06.76	05.81 06.81 01.79 06.81 07.79 06.81	- belüftete Scheiben 6) + 5) - belüftete Scheiben 6) - belüftete Scheiben 6) - belüftete Scheiben 6) - belüftete Scheiben 6)		13.0441-4018.2	250083			Dichtungssatz	ATE
	518 520 4 520 6 520 i 525 528 528 i	85 90		08.76 08.76 08.77 08.76 06.76 08.76 03.77	05.81 01.79 06.81 07.79 06.81 07.77 06.81	+ belüftete Scheiben 7) + belüftete Scheiben 7) + belüftete Scheiben 7) + belüftete Scheiben 7) + belüftete Scheiben 7)		13.0441-4018.2	250083			Dichtungssatz	ATE

1) + pipe line / + tubazione / + conduite rigide / + latiguillo
2) + autom.transmission / + scatola cambio automatico / + transmission automatique / + cambio automático
3) + manual transmission / + scatola cambio velocità / + transmission mécanique / + cambio de velocidad
4) in engine compartment / nel vano motore / dans compartiment moteur / en compartimento de motor
5) + 5) / + autom.transmission / + 5) / + scatola cambio autom. / + 5) / + transmission automatique / + 5) / + cambio automático
6) - ventilated discs / - dischi ventilati / - disques ventilés / - disco ventilado
7) + ventilated discs / + dischi ventilati / + disques ventilés / + disco ventilado

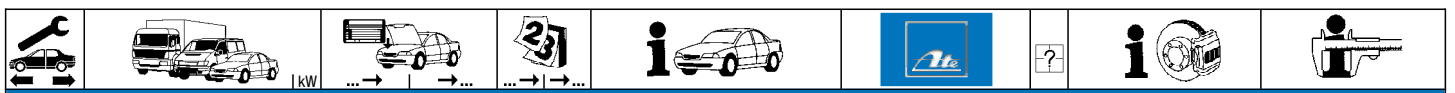

BMW 5er Reihe/E12 (72-81)

	518 520 4 520 i 525 528	85		06.74 06.72 10.72 10.73 01.75	07.76 07.76 07.76 07.76 07.76		13.0460-9030.2	609030				20092 15,0	ATE	
	518 518 i 520 4 520 6 520 i 525 528 528 i M 535 i	85 90 160		08.76 09.79 08.76 08.77 08.76 06.76 08.76 03.77 04.80	05.81 06.81 01.79 06.81 07.79 06.81 07.77 06.81 05.81	+ s	13.0460-9031.2 13.0460-0122.2 13.0460-0123.2 24.8190-0215.2	609031 610122 610123 620215	1			- belüftete Scheiben ¹⁾ + belüftete Scheiben ²⁾	20437 19,0 /WE Belagsatz-Zubehör Belagsatz-Zubehör Warnkontakt L=162mm	ATE ATE ATE
	518 518 i 520 4 520 6 520 i 525 528 528 i M 535 i	85 90 160		02.76 09.79 02.76 08.77 02.76 02.76 02.76 03.77 04.80	05.81 06.81 01.79 06.81 07.79 06.81 07.77 06.81 05.81	+ s	24.0113-0139.1	413139				280 12,7 11,1		
	518 520 4 520 6 520 i 525 528 528 i M 535 i	85 90 160		08.76 08.76 08.77 08.76 06.76 08.76 03.77 04.80	05.81 01.79 06.81 07.79 06.81 07.77 06.81 05.81		24.0122-0111.1	422111				280 22,0 20,4 V		
	518 518 i 520 4 520 6 520 i 525 528 528 i M 535 i	85 90 160		06.74 09.79 06.72 08.77 10.72 10.73 01.75 03.77 04.80	05.81 06.81 01.79 06.81 07.79 06.81 07.77 06.81 05.81	+ s	24.5201-0290.3	331401	4			L=290		
	525 528 528 i M 535 i	160		10.73 01.75 03.77 04.80	06.81 07.77 06.81 05.81		13.2421-8005.2 13.2421-8006.2 24.9242-8005.5 24.9242-8006.5 13.0441-4205.2	210053 210054 230027 230028 250086				D=42 D=42 D=42 D=42 Dichtungssatz	ATE ATE ATE ATE ATE	
	525 528 528 i M 535 i	160		10.73 01.75 03.77 04.80	06.81 07.77 06.81 05.81		13.0460-3024.2 13.0460-0014.2 24.8190-0215.2	603024 610014 620215	1			20436 15,0 /WE Belagsatz-Zubehör Warnkontakt L=162mm	ATE ATE	
	525 528 528 i M 535 i	160		10.73 01.75 03.77 04.80	06.81 07.77 06.81 05.81		24.0110-0110.1	410110				272 9,5 7,9		
	518 518 i 520 4 520 6 520 i 525 528 528 i	85 90		06.74 09.79 06.72 08.77 10.72 10.73 01.75 03.77	05.81 06.81 01.79 06.81 07.79 06.81 07.77 06.81	+ s	24.5201-0204.3	331400	2			L=204		
	518 520 4 520 6 520 i	85 90		06.74 06.72 08.77 10.72	05.81 01.79 06.81 07.79		03.3222-4211.3	020075				Rz 22,20		
	518 518 i 520 4 520 6 520 i	85 90		06.74 09.79 06.72 08.77 10.72	05.81 06.81 01.79 06.81 07.79	+ s	03.0137-0009.2	650009				250 x 42 HEB		
	525 528 528 i M 535 i	160		10.73 01.75 03.77 04.80	06.81 07.77 06.81 05.81		03.0137-0149.2	650149				160 x 25		
	518 520 4 520 i 525 528	85		06.74 06.72 10.72 10.73 01.75	05.75 05.75 05.75 05.75 05.75		03.0350-1919.2	071919				Gz Reparatursatz		
	518 518 i 520 4 520 6 520 i 525 528 528 i	85 90		06.75 09.79 06.75 08.77 06.75 06.75 06.75 03.77	05.81 06.81 01.79 06.81 07.79 06.81 07.77 06.81	+ s	03.2419-9000.3 03.0350-1919.2	030025 071919				Gz 19,05 Gz Reparatursatz		

1) - ventilated discs / - dischi ventilati / - disques ventilés / - disco ventilado
2) + ventilated discs / + dischi ventilati / + disques ventilés / + disco ventilado



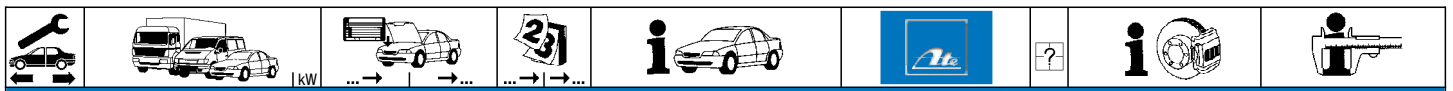

BMW 5er Reihe/E12 (72-81)										
	M 535 i	160		04.80	05.81		03.2419-9000.3	030025		Gz 19,05
							03.0350-1919.2	071919		Gz Reparatursatz
	518 520 4 520 i 525 528	85		06.74 06.72 10.72 10.73 01.75	05.75 05.75 05.75 05.75		03.2520-1001.3	040009		Nz 20,64
	518 518 i 520 4 520 6 520 i 525 528 M 535 i	85 90 160		06.75 09.79 06.75 08.77 06.75 06.75 03.77 04.80	05.81 06.81 01.79 06.81 07.79 06.81 06.81 05.81	+ ⑤	03.2520-1201.3 03.0450-2006.2	040011 082006		Nz 20,64 Nz Reparatursatz

BMW 5er Reihe/E28 (81-87)										
	518 518 i 520 i	66		06.81 11.83 06.81	09.84 12.87 12.87		03.7760-0902.4	300088		10" ATE
	524 d 524 td 525 e 525 e	63 85		05.86 09.83 09.81 09.81	12.87 12.87 11.86 12.87	+ ABS + ABS - ABS + ABS				
	525 i 528 i 535 i M 535 i M5	110 135 211		02.81 06.81 01.85 01.85 08.85	12.87 12.87 12.87 12.87		10.0144-4234.3 10.0504-0113.3 10.0522-4005.1 10.0522-4002.1 10.0515-0515.3	340014 340021 340029 340028 340024		Hydraulik Verstärker DS Regler Warnschalter M10x1 Warnschalter M12x1 Hydraulikspeicher ATE
	518 518 i 520 i	66		06.81 11.83 06.81	09.84 12.87 08.84	- ABS/ - Behörde 1) - ABS/ - Behörde 1) - ABS/ - Behörde 1)	03.2122-6911.3	010153		THz 22,20 ATE
	518 518 i 520 i 520 i 525 e	66		06.81 11.83 09.84 06.81 09.81	09.84 12.87 12.87 12.87 12.87	- ABS/ + Behörde 2) - ABS/ + Behörde 2) - ABS/ - Behörde 1) + Behörde 3) - ABS	03.2123-8311.3	010192		THz 23,81 ATE
	524 td 524 td	85 85		09.83 09.84	08.84 12.87	- ABS/ - Behörde 1) - ABS/ - Behörde 1)	03.2122-6911.3 03.2123-8311.3	010153 010192		THz 22,20 ATE THz 23,81 ATE
	525 i 525 i 528 i 535 i M 535 i	110 110 135		02.81 02.81 06.81 01.85 01.85	12.87 08.86 03.86 08.86 08.86	- ABS - ABS - ABS + ABS + ABS	03.2123-8312.3	010193		THz 23,81 ATE
	518 518 i 520 i 524 d 524 td 525 e 525 i 525 i 528 i 528 i 535 i 535 i M 535 i M 535 i M5	66 63 85 110 110 135 135 211		06.81 11.83 06.81 05.86 09.83 09.81 02.81 02.81 06.81 06.81 01.85 01.85 01.85 01.85 08.85	09.84 12.87 12.87 12.87 12.87 12.87 12.87 08.86 12.87 08.86 12.87 08.86 12.87 08.86 12.87	+ ABS + ABS + ABS + ABS + ABS + ABS + ABS + ABS + ABS + ABS + ABS/ - ABS + ABS + ABS/ - ABS	03.2123-8711.3	010196		THz 23,81 ATE
	525 i 528 i 535 i M 535 i M5	110 135 211		09.86 09.86 09.86 09.86 08.85	12.87 12.87 12.87 12.87		03.2123-0242.3	010163		THz 23,81 ATE
	518 518 i 520 i 524 td	66 85		06.81 11.83 06.81 09.83	09.84 12.87 08.84 08.84	- ABS/ - Behörde 1) - ABS/ - Behörde 1) - ABS/ - Behörde 1) - ABS/ - Behörde 1)	11.0441-5402.2 11.0101-5402.2 11.8171-0008.1 11.8116-0091.1	250028 260009 990049 390502	2	Dichtungssatz ATE Hülensatz ATE Führungsbolzen ATE Haltefeder ATE
	518 518 i 520 i 520 i 524 d 524 td 524 td 525 e 525 i 528 i	66 63 85 85 110 135		06.81 11.83 09.84 06.81 05.86 09.84 09.83 09.81 02.81 06.81	09.84 12.87 12.87 12.87 12.87 12.87 12.87 12.87 12.87 05.84	+ ABS/ + Behörde 4) + ABS/ + Behörde 4) - ABS + ABS/ + Behörde 4) - ABS + ABS/ + Behörde 4) + ABS/ + Behörde 4) + ABS/ + Behörde 4) + ABS/ + Behörde 4) + ABS/ + Behörde 4)	11.0441-5702.2 11.0101-5402.2 11.8171-0008.1 11.8116-0091.1	250033 260009 990049 390502	2	Dichtungssatz ATE Hülensatz ATE Führungsbolzen ATE Haltefeder ATE
	528 i 535 i M 535 i	135		06.84 01.85 01.85	12.87 12.87 12.87		11.0441-5702.2 11.0101-5402.2 11.8171-0008.1 11.8116-0091.1	250033 260009 990049 390502	2	Dichtungssatz ATE Hülensatz ATE Führungsbolzen ATE Haltefeder ATE
	M5	211		08.85	12.87		13.0441-4018.2	250083		Dichtungssatz ATE

1) - ABS/ - authority cars / - ABS/ - enti statali / - ABS/ - véhicule communal / - ABS/ - vehiculos oficiales
 2) - ABS/ + authority cars / - ABS/ + enti statali / - ABS/ + véhicule communal / - ABS/ + vehiculos oficiales
 3) + authority cars / + enti statali / + véhicule communal / + vehiculos oficiales
 4) + ABS/ + authority cars / + ABS/ + enti statali / + ABS/ + véhicule communal / + ABS/ + vehiculos oficiales



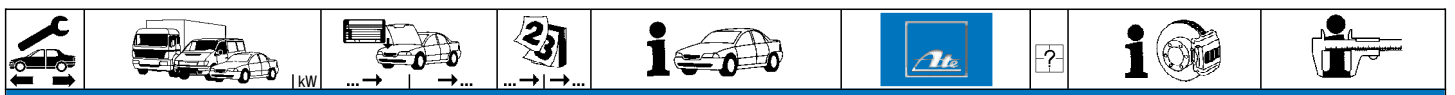

BMW 5er Reihe/E28 (81-87)

	518 518 i 520 i 524 d 524 td 525 e 525 i 528 i 535 i M 535 i M5	66 63 85 110 135 211	06.81 11.83 06.81 05.86 09.83 09.81 02.81 06.81 01.85 01.85 08.85	09.84 12.87 12.87 12.87 12.87 12.87 12.87 12.87 12.87 12.87 12.87	13.0460-7046.2 24.8190-0213.2	607046 620213	1	20629 20,3 +/WE Warnkontakt L=262mm	ATE
	518 518 i 520 i 524 td	66 85	06.81 11.83 06.81 09.83	09.84 12.87 08.84 08.84	- ABS/ - Behörde ¹⁾ - ABS/ - Behörde ¹⁾ - ABS/ - Behörde ¹⁾ - ABS/ - Behörde ¹⁾	24.0112-0111.1	412111	284 12,0 10,4	
	518 518 i 520 i 524 d 524 td 525 e 525 i 528 i 528 i 535 i M 535 i	66 63 85 85 110 135 135	06.81 11.83 06.81 09.84 05.86 09.83 09.84 09.81 02.81 06.81 01.85	09.84 12.87 08.84 12.87 12.87 12.87 12.87 12.87 12.87 12.87 05.84	+ ABS/ + Behörde ²⁾ + ABS/ + Behörde ²⁾ + ABS/ + Behörde ²⁾ + ABS/ + Behörde ²⁾	24.0122-0135.1	422135	284 22,0 20,4 V	
	518 518 i 520 i 524 d 524 td 525 e 525 i 528 i 535 i M 535 i	66 63 85 85 110 135	06.81 11.83 06.81 05.86 09.83 09.81 02.81 06.81 01.85 01.85	09.84 12.87 12.87 12.87 12.87 12.87 12.87 12.87 12.87 12.87		83.6124-0422.3	330269	L=420	
	518 518 i 520 i 520 i 524 d 524 td 524 td 525 e 525 i 528 i 535 i M 535 i M5	66 63 85 85 110 135 211	06.81 11.83 06.81 04.86 05.86 09.83 04.86 09.81 02.81 06.81 01.85 01.85 08.85	09.84 12.87 03.86 12.87 12.87 03.86 12.87 12.87 12.87 12.87 12.87 12.87 12.87	+ ABS + ABS + ABS	11.3331-8501.2 11.3331-8502.2 24.3331-8501.5 24.3331-8502.5 11.0441-3302.2 11.0101-5402.2 11.8171-0008.1 11.8116-0015.1	220004 220005 240509 240510 250004 260009 990049 390492	D=33, - Halter D=33, - Halter D=33, - Halter D=33, - Halter Dichtungssatz Hülssensatz Führungsbolzen Haltefeder	ATE ATE ATE ATE ATE ATE ATE
	518 518 i 520 i 520 i 524 d 524 td 524 td 525 e 525 i 528 i 535 i M 535 i M5	66 63 85 85 110 135 211	06.81 11.83 06.81 04.86 05.86 09.83 04.86 09.81 02.81 06.81 01.85 01.85 08.85	09.84 12.87 03.86 12.87 12.87 03.86 12.87 12.87 12.87 12.87 12.87 12.87 12.87	+ ABS + ABS + ABS	13.0460-7047.2 24.8190-0215.2	607047 620215	20675 16,5 +/WE Warnkontakt L=162mm	ATE
	518 518 i 520 i 520 i 524 d 524 td 524 td 525 e 525 i 528 i 535 i M 535 i M5	66 63 85 85 110 135 211	06.81 11.83 06.81 04.86 05.86 09.83 04.86 09.81 02.81 06.81 01.85 01.85 08.85	09.84 12.87 03.86 12.87 12.87 03.86 12.87 12.87 12.87 12.87 12.87 12.87 12.87	+ ABS + ABS + ABS	24.0110-0174.1	410174	284 10,0 8,4	
	518 518 i 520 i 524 td	66 85	06.81 11.83 06.81 09.83	09.84 12.87 03.86 03.86	- ABS - ABS - ABS	24.5201-0204.3	331400	L=204	
	518 518 i	66	06.81 11.83	09.84 12.87	+ ABS + ABS	24.5201-0204.3 83.7704-0200.3	331400 330825	L=204 L=200	am Bremsattel ³⁾

¹⁾ - ABS/ - authority cars / - ABS/ - enti statali / - ABS/ - véhicule communal / - ABS/ - vehiculos oficiales
²⁾ + ABS/ + authority cars / + ABS/ + enti statali / + ABS/ + véhicule communal / + ABS/ + vehiculos oficiales
³⁾ on the brake caliper / sulla pinza freno / sur l'étrier de frein / a la pinza de freno



BMW 5er Reihe/E28 (81-87)																			
	520 i		06.81	03.86	+ ABS	24.5201-0204.3	331400	2	am Bremsattel ¹⁾	L=204									
	520 i		04.86	12.87															
	524 d	63	05.86	12.87															
	524 td	85	09.83	03.86	+ ABS														
	524 td	85	04.86	12.87															
	525 e		09.81	12.87															
	525 i	110	02.81	12.87															
	528 i	135	06.81	12.87															
	535 i		01.85	12.87															
	M 535 i		01.85	12.87															
M5	211	08.85	12.87																
	518	66	06.81	08.84	- ABS	03.3219-2106.3	020043			Rz 19,05									
	518 i		11.83	12.87	- ABS														
	520 i		06.81	08.84	- ABS														
	524 td	85	09.83	08.84	- ABS														
	520 i		09.84	03.86	- ABS	24.3220-1712.3	020406			Rz 20,64									
	524 td	85	09.84	03.86	- ABS														
	518	66	06.81	09.84	- ABS	03.0137-0152.2	650152			250 x 42 HEB									
	518 i		11.83	12.87	- ABS														
	520 i		06.81	03.86	- ABS														
	524 td	85	09.83	03.86	- ABS														
	518	66	06.81	09.84	+ ABS	03.0137-0150.2	650150			180 x 25									
	518 i		11.83	12.87	+ ABS														
	520 i		06.81	03.86	+ ABS														
	520 i		04.86	12.87															
	524 d	63	05.86	12.87															
	524 td	85	09.83	03.86	+ ABS														
	524 td	85	04.86	12.87															
	525 e		09.81	12.87															
	525 i	110	02.81	12.87															
	528 i	135	06.81	12.87															
	535 i		01.85	12.87															
	M 535 i		01.85	12.87															
	M5	211	08.85	12.87															
		518	66	06.81	09.84						- ABS	24.3727-0209.2	580209	2 ↓		L=1866			
		518 i		11.83	12.87						- ABS								
520 i			06.81	03.86	- ABS														
524 td		85	09.83	03.86	- ABS														
	518	66	06.81	09.84	+ ABS	24.3727-0220.2	580220	2 ↓		L=1715									
	518 i		11.83	12.87	+ ABS														
	520 i		06.81	03.86	+ ABS														
	520 i		04.86	12.87															
	524 d	63	05.86	12.87															
	524 td	85	09.83	03.86	+ ABS														
	524 td	85	04.86	12.87															
	525 e		09.81	12.87															
	525 i	110	02.81	12.87															
	528 i	135	06.81	12.87															
	535 i		01.85	12.87															
	M 535 i		01.85	12.87															
	M5	211	08.85	12.87															
		518	66	06.81	09.84							24.2419-0912.3	030044			Gz 19,05			
		518 i		11.83	12.87														
520 i			06.81	12.87															
524 d		63	05.86	12.87															
524 td		85	09.83	12.87															
525 e			09.81	12.87															
525 i		110	02.81	12.87															
528 i		135	06.81	12.87															
535 i			01.85	12.87															
M 535 i			01.85	12.87															
M5		211	08.85	12.87															
	518	66	06.81	09.84		03.2520-1201.3	040011			Nz 20,64									
	518 i		11.83	12.87															
	520 i		06.81	12.87															
	524 td	85	09.83	12.87															
	525 e		09.81	12.87															
	525 i	110	02.81	12.87															
	528 i	135	06.81	12.87															
	535 i		01.85	12.87															
	M 535 i		01.85	12.87															
	M5	211	08.85	12.87															
524 d	63	05.86	12.87		03.2522-3601.3	040014			Nz 22,20										
	518	66	06.81	09.84		24.5802-0320.3	330050		ohne Rohrleitung ²⁾	L=320									
	518 i		11.83	12.87															
	520 i		06.81	12.87															
	524 d	63	05.86	12.87															
	524 td	85	09.83	12.87															
	M 535 i		01.85	12.87															
M5	211	08.85	12.87																
	525 e		09.81	12.87		24.5905-0320.3	330058		ohne Rohrleitung ²⁾	L=320									
	525 i	110	02.81	12.87															
	528 i	135	06.81	12.87															
	535 i		01.85	12.87															

¹⁾ on the brake caliper / sulla pinza freno / sur l'étrier de frein / a la pinza de freno





















²⁾ without pipe line / senza tubazione / sans conduite de frein rigide / sin latiguillo

















BMW 5er Reihe/E34 (88-96)												
	518 i			04.89	08.91			03.2125-3011.3	010211		THz 25,40	ATE
	520 i	95		01.88	09.90							
	520 i 24V	110		03.89	08.91							
	524 td	85		03.88	08.91							
	525 i	125		01.88	09.90							
	525 i 24V	141		09.89	08.91							
	530 i	138		01.88	09.95							
	535 i	155		01.88	09.95							
	M5 3.6	232		04.88	09.95							
	M5 3.8	250		04.88	09.95							
	M5 Touring	250		09.94	11.96							
	518 i			09.91	09.95			03.2025-1211.3	010475		THz 25,40/20,64	ATE
	520 i 24V	110		09.91	09.95							
	525 i 24V	141		09.91	09.95							
	525 tds	105		09.91	09.95							
	530 i V8	160		03.92	08.93			24.2125-1716.3	010663		THz 25,40	
	530 i V8 Touring	160		05.92	08.93							
	540 i V8	210		03.92	08.93							
	518 i			04.89	09.95			11.3601-8501.2	220145		D=60, - Halter	ATE
	518 i Touring			03.93	09.95			24.3601-8501.5	240533		D=60, - Halter	ATE
	520 i	95		01.88	09.90	- Behörde 1)		24.3601-8502.5	240534		D=60, - Halter	ATE
	520 i 24V	110		03.89	09.95	- Behörde 1)		11.0441-6003.2	250037		Dichtungssatz	
	524 td	85		03.88	08.91			11.0230-0020.2	260023	2	Haltersatz	ATE
	525 td	85		04.93	09.95			11.0101-5402.2	260009		Hülsensatz	ATE
	525 tds	105		09.91	09.95			11.8171-0008.1	990049		Führungsbolzen	ATE
								11.8116-0083.1	390501	2	Haltefeder	ATE
	520 i	95		01.88	09.90	+ Behörde 2)		11.3601-8505.2	220149		D=60, - Halter	ATE
	520 i 24V	110		03.89	09.95	+ Behörde 2)		24.3601-8505.5	240537		D=60, - Halter	ATE
	520 i Touring	110		11.91	11.96			24.3601-8506.5	240538		D=60, - Halter	ATE
	525 i	125		01.88	09.90			11.0441-6003.2	250037		Dichtungssatz	
	525 i 24V	141		09.89	09.95			11.0101-5402.2	260009		Hülsensatz	ATE
	525 i Touring	141		11.91	11.96			11.8171-0008.1	990049		Führungsbolzen	ATE
	525 td Touring	85		03.93	11.96			11.8116-0083.1	390501	2	Haltefeder	ATE
	525 tds Touring	105		12.91	11.96							
	530 i	138		01.88	09.95							
	530 i V8	160		03.92	09.95							
	530 i V8 Touring	160		05.92	11.96							
	535 i	155		01.88	09.95							
	525 ix	141		04.91	09.95			11.0441-6003.2	250037		Dichtungssatz	
	525 ix Touring	141		02.92	11.96			11.0101-5402.2	260009		Hülsensatz	ATE
								11.8171-0008.1	990049		Führungsbolzen	ATE
	540 i Touring	210		05.93	11.96			24.3601-8503.5	240535		D=60, - Halter	ATE
	540 i V8	210		03.92	09.95			24.3601-8504.5	240536		D=60, - Halter	ATE
								11.0441-6003.2	250037		Dichtungssatz	
								11.0101-5402.2	260009		Hülsensatz	ATE
								11.8171-0008.1	990049		Führungsbolzen	ATE
	M5 3.6	232		10.88	09.95			11.0441-6003.2	250037		Dichtungssatz	
	M5 3.8	250		03.92	05.94			11.0101-5402.2	260009		Hülsensatz	ATE
								11.8171-0008.1	990049		Führungsbolzen	ATE
	518 i			04.89	09.95			13.0460-6033.2	606033		20968 20,3 +/WE	ATE
	518 i Touring			03.93	11.96			24.8190-0214.2	620214	1	Warnkontakt L=235mm	
	520 i	95		01.88	09.90							
	520 i 24V	110		03.89	09.95							
	520 i Touring	110		11.91	11.96							
	524 td	85		03.88	08.91							
	525 i	125		01.88	09.90							
	525 i 24V	141		09.89	09.95							
	525 i Touring	141		11.91	11.96							
	525 td	85		04.93	09.95							
	525 td Touring	85		03.93	11.96							
	525 tds	105		09.91	09.95							
	525 tds Touring	105		12.91	11.96							
	530 i	138		01.88	09.95							
	530 i V8	160		03.92	09.95							
	530 i V8 Touring	160		05.92	11.96							
	535 i	155		01.88	09.95							
	540 i Touring	210		05.93	11.96							
	540 i V8	210		03.92	09.95							
	M5 3.6	232		10.88	09.95							
	M5 3.8	250		03.92	05.94							
	525 ix	141		04.91	09.95			13.0460-6033.2	606033		20968 20,3 +/WE	ATE
	525 ix Touring	141		02.92	11.96			24.8190-0224.2	620224	1	Warnkontakt L=311mm	
	M5 3.8	250		03.92	09.95			13.0460-9037.2	609037		20309 17,9 /WE	ATE
	M5 Touring	250		09.94	11.96			24.8190-0214.2	620214	1	Warnkontakt L=235mm	
	518 i			04.89	09.95			24.0112-0124.1	412124		302 12,0 10,4 L +S +B	
	518 i Touring			03.93	11.96							
	520 i	95		01.88	09.90	- Behörde 1)						
	520 i 24V	110		03.89	09.95	- Behörde 1)						
	524 td	85		03.88	08.91							
	525 td	85		04.93	09.95							
	525 tds	105		09.91	09.95							
	520 i	95		01.88	09.90	+ Behörde 2)		24.0122-0103.1	422103		302 22,0 20,4 V L +S +B	
	520 i 24V	110		03.89	09.95	+ Behörde 2)		24.0322-0103.1	522103		302 22,0 19,6 V L +S +B PD	
	520 i Touring	110		11.91	11.96							
	525 i	125		01.88	09.90							
	525 i 24V	141		09.89	09.95							

1) - authority cars / - enti statai / - véhicule communal / - vehiculos oficiales
 2) + authority cars / + enti statai / + véhicule communal / + vehiculos oficiales



									
BMW 5er Reihe/E34 (88-96)									
	525 i Touring	141	11.91	11.96	24.0122-0103.1	422103		302 22,0 20,4 V L +S +B	
	525 td Touring	85	03.93	11.96	24.0322-0103.1	522103		302 22,0 19,6 V L +S +B PD	
	525 tds Touring	105	12.91	11.96					
	530 i	138	01.88	09.95					
	530 i V8	160	03.92	09.95					
	530 i V8 Touring	160	05.92	11.96					
	535 i	155	01.88	09.95					
	525 ix	141	04.91	09.95	24.0128-0122.1	428122		296 28,0 26,4 V L +B	
	525 ix Touring	141	02.92	11.96					
	540 i Touring	210	05.93	11.96	24.0128-0101.1	428101		302 28,0 26,4 V L +B	
	540 i V8	210	03.92	09.95					
	518 i		04.89	09.95	24.5113-0423.3	331396	2	L=423	
	518 i Touring		03.93	11.96					
	520 i	95	01.88	09.90					
	520 i 24V	110	03.89	09.95					
	520 i Touring	110	11.91	11.96					
	524 td	85	03.88	08.91					
	525 i	125	01.88	09.90					
	525 i 24V	141	09.89	09.95					
	525 i Touring	141	11.91	11.96					
	525 ix	141	04.91	08.91					
	525 ix Touring	141	02.92	11.96					
	525 td	85	04.93	09.95					
	525 td Touring	85	03.93	11.96					
	525 tds	105	09.91	09.95					
	525 tds Touring	105	12.91	11.96					
	530 i	138	01.88	09.95					
	530 i V8	160	03.92	09.95					
	530 i V8 Touring	160	05.92	11.96					
	535 i	155	01.88	09.95					
	540 i Touring	210	05.93	11.96					
	540 i V8	210	03.92	09.95					
	M5 3.6	232	10.88	09.95					
	M5 3.8	250	10.88	09.95					
	M5 Touring	250	09.94	11.96					
	518 i		04.89	09.95	11.3381-8504.2	220021		D=38, - Halter	ATE
	520 i	95	01.88	09.90	24.3381-8503.5	240515		D=38, - Halter	ATE
	520 i 24V	110	03.89	09.95	24.3381-8504.5	240516		D=38, - Halter	ATE
	524 td	85	03.88	08.91	11.0441-3803.2	250010		Dichtungssatz	ATE
	525 i	125	01.88	09.90	11.0101-5402.2	260009		Hülzensatz	ATE
	525 i 24V	141	09.89	09.95	11.8171-0008.1	990049		Führungsbolzen	ATE
	525 ix	141	04.91	09.95	11.8116-0066.1	390577	2	Haltefeder	ATE
	525 td	85	04.93	09.95					
	525 tds	105	09.91	09.95					
	530 i	138	01.88	09.95					
	530 i V8	160	03.92	09.95					
	535 i	155	01.88	09.95					
	M5 3.6	232	04.88	09.88					
	M5 3.8	250	04.88	09.88					
	M5 3.6	232	10.88	12.89	11.0441-4002.2	250011		Dichtungssatz	ATE
	M5 3.8	250	10.88	12.89	11.0101-5402.2	260009		Hülzensatz	ATE
					11.8171-0008.1	990049		Führungsbolzen	ATE
					11.8116-0296.1	390445	2	Haltefeder	ATE
	518 i Touring		11.92	11.96	11.3401-8503.2	220030		D=40, - Halter	ATE
	520 i Touring	110	11.91	11.96	11.3401-8504.2	220031		D=40, - Halter	ATE
	525 i Touring	141	11.91	11.96	24.3401-8503.5	240521		D=40, - Halter	ATE
	525 ix Touring	141	02.92	11.96	24.3401-8504.5	240522		D=40, - Halter	ATE
	525 td Touring	85	03.93	11.96	11.0441-4002.2	250011		Dichtungssatz	ATE
	525 tds Touring	105	12.91	11.96	11.0101-5402.2	260009		Hülzensatz	ATE
	530 i V8 Touring	160	05.92	11.96	11.8171-0008.1	990049		Führungsbolzen	ATE
					11.8116-0066.1	390577	2	Haltefeder	ATE
	540 i Touring	210	05.93	11.96	11.0441-4002.2	250011		Dichtungssatz	ATE
	540 i V8	210	03.92	09.95	11.0101-5402.2	260009		Hülzensatz	ATE
	M5 3.6	232	01.90	09.95	11.8171-0008.1	990049		Führungsbolzen	ATE
	M5 3.8	250	03.92	05.94	11.8116-0066.1	390577	2	Haltefeder	ATE
	M5 3.8	250	06.94	09.95	11.0441-4002.2	250011		Dichtungssatz	ATE
	M5 Touring	250	09.94	11.96	11.0101-5402.2	260009		Hülzensatz	ATE
					11.8171-0008.1	990049		Führungsbolzen	ATE
					11.8116-0315.2	390447	2	Haltefeder	ATE
	518 i		04.89	09.95	13.0460-3803.2	603803	1	20995 17,3 +/WE	ATE
	518 i Touring		03.93	11.96	24.8190-0214.2	620214		Warnkontakt L=235mm	
	520 i	95	01.88	09.90					
	520 i 24V	110	03.89	09.95					
	520 i Touring	110	11.91	11.96					
	524 td	85	03.88	08.91					
	525 i	125	01.88	09.90					
	525 i 24V	141	09.89	09.95					
	525 i Touring	141	11.91	11.96					
	525 ix	141	04.91	09.95					
	525 ix Touring	141	02.92	11.96					
	525 td	85	04.93	09.95					
	525 td Touring	85	03.93	11.96					
	525 tds	105	09.91	09.95					
	525 tds Touring	105	12.91	11.96					
	530 i	138	01.88	09.95					
	530 i V8	160	03.92	09.95					
	530 i V8 Touring	160	05.92	11.96					





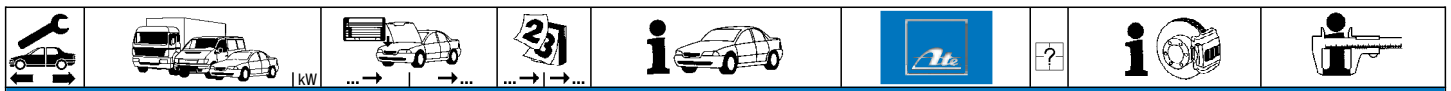















									
BMW 5er Reihe/E34 (88-96)									
	535 i	155		01.88	09.95	13.0460-3803.2	603803		20995 17,3 +WE ATE
	540 i Touring	210		05.93	11.96	24.8190-0214.2	620214	1	Warnkontakt L=235mm
	540 i V8	210		03.92	09.95				
	M5 3.6	232		10.88	09.95				
	M5 3.8	250		03.92	05.94				
	M5 3.8	250		06.94	09.95	24.8190-0214.2	620214	1	Warnkontakt L=235mm
	M5 Touring	250		09.94	11.96				
	518 i			04.89	09.95	24.0110-0117.1	410117		300 10,0 8,4 L +S +B
	518 i Touring			03.93	11.96	24.0310-0117.1	510117		300 10,0 7,6 L +S +B PD
	520 i	95		01.88	09.90				
	520 i 24V	110		03.89	09.95				
	520 i Touring	110		11.91	11.96				
	524 td	85		03.88	08.91				
	525 i	125		01.88	09.90				
	525 i 24V	141		09.89	09.95				
	525 i Touring	141		11.91	11.96				
	525 td	85		04.93	09.95				
	525 td Touring	85		03.93	11.96				
	525 tds	105		09.91	09.95				
	525 tds Touring	105		12.91	11.96				
	530 i	138		01.88	09.95				
	530 i V8	160		03.92	09.95				
	530 i V8 Touring	160		05.92	11.96				
	535 i	155		01.88	09.95				
	M5 3.6	232		10.88	09.89				
	525 ix	141		04.91	09.95	24.0110-0262.1	410262		300 10,0 8,4
	525 ix Touring	141		02.92	11.96				
	540 i Touring	210		05.93	11.96	24.0120-0181.1	420181		300 20,0 18,4 V L +B
	540 i V8	210		03.92	09.95				
	M5 3.6	232		10.89	09.95				
	M5 3.8	250		03.92	05.94				
	518 i			04.89	08.91	24.5201-0204.3	331400	2	L=204
	518 i			04.89	09.95	24.5201-0204.3	331400	2	L=204
	518 i Touring			03.93	11.96	83.7704-0200.3	330825	2	L=200
	520 i	95		01.88	09.90				
	520 i 24V	110		03.89	09.95				
	520 i Touring	110		11.91	11.96				
	524 td	85		03.88	08.91				
	525 i	125		01.88	09.90				
	525 i 24V	141		09.89	09.95				
	525 i Touring	141		11.91	11.96				
	525 ix	141		04.91	09.95				
	525 ix Touring	141		02.92	11.96				
	525 td	85		04.93	09.95				
	525 td Touring	85		03.93	11.96				
	525 tds	105		09.91	09.95				
	525 tds Touring	105		12.91	11.96				
	530 i	138		01.88	09.95				
	530 i V8	160		03.92	09.95				
	530 i V8 Touring	160		05.92	11.96				
	535 i	155		01.88	09.95				
	540 i Touring	210		05.93	11.96				
	540 i V8	210		03.92	09.95				
	M5 3.6	232		10.88	09.95				
	M5 3.8	250		10.88	09.95				
	M5 Touring	250		09.94	11.96				
	518 i			04.89	08.91	03.0137-0152.2	650152		250 x 42 HEB
						03.0137-9077.2	669077		Bremsbacken-Zubehör
	518 i			04.89	09.95	03.0137-0150.2	650150		180 x 25
	518 i Touring			03.93	11.96	03.0137-9062.2	669062		Bremsbacken-Zubehör
	520 i	95		01.88	09.90				
	520 i 24V	110		03.89	09.95				
	520 i Touring	110		11.91	11.96				
	524 td	85		03.88	08.91				
	525 i	125		01.88	09.90				
	525 i 24V	141		09.89	09.95				
	525 i Touring	141		11.91	11.96				
	525 ix	141		04.91	09.95				
	525 ix Touring	141		02.92	11.96				
	525 td	85		04.93	09.95				
	525 td Touring	85		03.93	11.96				
	525 tds	105		09.91	09.95				
	525 tds Touring	105		12.91	11.96				
	530 i	138		01.88	09.95				
	530 i V8	160		03.92	09.95				
	530 i V8 Touring	160		05.92	11.96				
	535 i	155		01.88	09.95				
	540 i Touring	210		05.93	11.96				
	540 i V8	210		03.92	09.95				
	M5 3.6	232		10.88	09.95				
	M5 3.8	250		10.88	09.95				
	M5 Touring	250		09.94	11.96				

¹⁾ on the brake caliper / sulla pinza freno / sur l'étrier de frein / a la pinza de freno



BMW 5er Reihe/E34 (88-96)

	518 i		04.89	09.95 + ABS	24.3727-0215.2	580215	2 ↓	L=1755
	518 i Touring		03.93	11.96				
	520 i	95	01.88	09.90				
	520 i 24V	110	03.89	09.95				
	520 i Touring	110	11.91	11.96				
	524 td	85	03.88	08.91				
	525 i	125	01.88	09.90				
	525 i 24V	141	09.89	09.95				
	525 i Touring	141	11.91	11.96				
	525 ix	141	04.91	09.95				
	525 ix Touring	141	02.92	11.96				
	525 td	85	04.93	09.95				
	525 td Touring	85	03.93	11.96				
	525 tds	105	09.91	09.95				
	525 tds Touring	105	12.91	11.96				
	530 i	138	01.88	09.95				
	530 i V8	160	03.92	09.95				
530 i V8 Touring	160	05.92	11.96					
535 i	155	01.88	09.95					
540 i Touring	210	05.93	11.96					
540 i V8	210	03.92	09.95					
M5 3.6	232	10.88	09.95					
M5 3.8	250	10.88	09.95					
M5 Touring	250	09.94	11.96					
	518 i		04.89	09.95	24.2419-0922.3	030051		Gz 19,05
	518 i Touring		03.93	11.96				
	520 i	95	01.88	09.90				
	520 i 24V	110	03.89	09.95				
	520 i Touring	110	11.91	11.96				
	524 td	85	03.88	08.91				
	525 i	125	01.88	09.90				
	525 i 24V	141	09.89	09.95				
	525 i Touring	141	11.91	11.96				
	525 ix	141	04.91	09.95				
	525 ix Touring	141	02.92	11.96				
	525 td	85	04.93	09.95				
	525 td Touring	85	03.93	11.96				
	525 tds	105	09.91	09.95				
	525 tds Touring	105	12.91	11.96				
	530 i	138	01.88	09.95				
	530 i V8	160	03.92	09.95				
530 i V8 Touring	160	05.92	11.96					
535 i	155	01.88	09.95					
540 i Touring	210	05.93	11.96					
540 i V8	210	03.92	09.95					
	518 i		04.89	09.95	24.2522-0905.3	040042		Nz 22,20
	518 i Touring		03.93	11.96				
	520 i 24V	110	11.90	09.95				
	520 i Touring	110	11.91	11.96				
	524 td	85	09.90	08.91				
	525 i 24V	141	09.89	09.95				
	525 i Touring	141	11.91	11.96				
	525 ix	141	04.91	09.95				
	525 ix Touring	141	02.92	11.96				
	525 td	85	04.93	09.95				
	525 td Touring	85	03.93	11.96				
	525 tds	105	09.91	09.95				
	525 tds Touring	105	12.91	11.96				
530 i V8	160	03.92	09.95					
530 i V8 Touring	160	05.92	11.96					
	520 i	95	01.88	09.90	03.2522-3601.3	040014		Nz 22,20
	520 i 24V	110	03.89	10.90				
	524 td	85	03.88	08.90				
	525 i	125	01.88	09.90				
	530 i	138	01.88	09.95				
	535 i	155	01.88	09.95				
	540 i Touring	210	05.93	11.96	24.2526-0902.3	040052		Nz 26,99
	540 i V8	210	03.92	09.95				
	518 i		04.89	09.95	24.5905-0320.3	330058		L=320
	518 i Touring		03.93	11.96				
	520 i	95	01.88	09.90				
	520 i 24V	110	03.89	09.95				
	520 i Touring	110	11.91	11.96				
	524 td	85	03.88	08.91				
	525 i	125	01.88	09.90				
	525 i 24V	141	09.89	09.95				
	525 i Touring	141	11.91	11.96				
	525 ix	141	04.91	09.95				
	525 ix Touring	141	02.92	11.96				
	525 td	85	04.93	09.95				
	525 td Touring	85	03.93	11.96				
	525 tds	105	09.91	09.95				
	525 tds Touring	105	12.91	11.96				
	530 i	138	01.88	09.95				
	535 i	155	01.88	09.95				

										
BMW 6er Reihe/E24 (76-89)										
	628 CSi 635 CSi M 635 CSi	135		05.82 05.82 04.84	05.87 04.89 04.89	10.0144-4234.3 10.0504-0113.3 10.0522-4005.1 10.0522-4002.1 10.0515-0515.3	340014 340021 340029 340028 340024	Hydraulik Verstärker DS Regler Warnschalter M10x1 Warnschalter M12x1 Hydraulikspeicher	ATE	
	628 CSi 630 CS 633 CSi 635 CSi	135 136 136 136		09.79 02.76 01.76 06.78	04.82 08.79 04.82 04.82	03.2123-7002.3	010187	THz 23,81	ATE	
	628 CSi	135		05.82	08.84	- ABS	03.2123-8312.3	010193	THz 23,81	ATE
	628 CSi	135		05.82	05.87	+ ABS	03.2123-8711.3	010196	THz 23,81	ATE
	628 CSi	135		05.82	08.86	+ ABS				
	635 CSi	136		05.82	04.89					
	635 CSi	136		05.82	08.86					
	M 635 CSi	136		04.84	04.89					
	M 635 CSi	136		04.84	08.86					
	628 CSi	135		09.86	05.87	+ ABS	03.2123-0242.3	010163	THz 23,81	ATE
	635 CSi	136		09.86	04.89					
	M 635 CSi	136		09.86	04.89					
	630 CS 633 CSi	136 136		02.76 01.76	07.78 07.78	+ Automatikgetriebe ¹⁾ + Automatikgetriebe ¹⁾	03.3508-8802.3	310051	Behälter + WE	
	630 CS 633 CSi	136 136		02.76 01.76	08.76 08.76		13.0441-4018.2	250083	Dichtungssatz	ATE
	628 CSi	135		09.79	04.82		13.0441-4018.2	250083	Dichtungssatz	ATE
	630 CS	136		09.76	08.79					
	633 CSi	136		09.76	04.82					
	635 CSi	136		06.78	04.82					
	628 CSi	135		05.82	05.87		11.0441-5702.2	250033	Dichtungssatz	ATE
	635 CSi	136		05.82	04.89		11.0101-5402.2	260009	Hülzensatz	ATE
							11.8171-0008.1	990049	Führungsbolzen	ATE
							11.8116-0091.1	390502	Haltefeder	ATE
	M 635 CSi	136		04.84	04.89		13.0441-4018.2	250083	Dichtungssatz	ATE
	630 CS 633 CSi	136 136		02.76 01.76	08.76 08.76		13.0460-9030.2	609030	20092 15,0	ATE
	628 CSi	135		09.79	04.82		13.0460-9031.2	609031	20437 19,0 /WE	ATE
	630 CS	136		09.76	08.79		13.0460-0123.2	610123	Belagsatz-Zubehör	ATE
	633 CSi	136		09.76	04.82		24.8190-0215.2	620215	Warnkontakt L=162mm	
	635 CSi	136		06.78	04.82					
	628 CSi	135		05.82	05.87		13.0460-7046.2	607046	20629 20,3 +/-WE	ATE
	635 CSi	136		05.82	04.89		24.8190-0213.2	620213	Warnkontakt L=262mm	
	M 635 CSi	136		04.84	04.89		13.0460-9031.2	609031	20437 19,0 /WE	ATE
							24.8190-0214.2	620214	Warnkontakt L=235mm	
	628 CSi 630 CS 633 CSi 635 CSi	135 136 136 136		09.79 02.76 01.76 06.78	04.82 08.79 04.82 04.82		24.0122-0111.1	422111	280 22,0 20,4 V	
	628 CSi	135		05.82	05.87		24.0125-0104.1	425104	282 25,0 23,4 V L	
	635 CSi	136		05.82	04.89					
	628 CSi 630 CS 633 CSi 635 CSi	135 136 136 136		09.79 02.76 01.76 06.78	04.82 08.79 04.82 04.82		24.5201-0290.3	331401	L=290	
	628 CSi	135		05.82	05.87		83.6124-0422.3	330269	L=420	
	635 CSi	136		05.82	04.89					
	628 CSi 630 CS 633 CSi 635 CSi	135 136 136 136		09.79 02.76 01.76 06.78	04.82 08.79 04.82 04.82		24.9242-8007.5 24.9242-8008.5 13.0441-4205.2	230029 230030 250086	D=42 D=42 Dichtungssatz	ATE ATE ATE
	628 CSi	135		05.82	05.87		11.3331-8501.2	220004	D=33, - Halter	ATE
	635 CSi	136		05.82	04.89		11.3331-8502.2	220005	D=33, - Halter	ATE
							24.3331-8501.5	240509	D=33, - Halter	ATE
							24.3331-8502.5	240510	D=33, - Halter	ATE
							11.0441-3302.2	250004	Dichtungssatz	ATE
							11.0101-5402.2	260009	Hülzensatz	ATE
							11.8171-0008.1	990049	Führungsbolzen	ATE
							11.8116-0015.1	390492	Haltefeder	ATE
	M 635 CSi	136		04.84	04.89		11.0101-5402.2	260009	Hülzensatz	ATE
							11.8171-0008.1	990049	Führungsbolzen	ATE
							11.8116-0015.1	390492	Haltefeder	ATE
	628 CSi 630 CS 633 CSi 635 CSi	135 136 136 136		09.79 02.76 01.76 06.78	04.82 08.79 04.82 04.82		13.0460-3024.2 13.0460-0125.2 24.8190-0215.2	603024 610125 620215	20436 15,0 /WE Belagsatz-Zubehör Warnkontakt L=162mm	ATE ATE ATE
	628 CSi	135		05.82	05.87		13.0460-7047.2	607047	20675 16,5 +/-WE	ATE
	635 CSi	136		05.82	04.89		24.8190-0215.2	620215	Warnkontakt L=162mm	
	M 635 CSi	136		04.84	04.89					
	628 CSi 635 CSi M 635 CSi	135 136 136		05.82 05.82 04.84	05.87 04.89 04.89		24.0110-0174.1	410174	284 10,0 8,4	
	628 CSi 630 CS 633 CSi 635 CSi	135 136 136 136		09.79 02.76 01.76 06.78	04.82 08.79 04.82 04.82		24.5201-0204.3	331400	L=204	

¹⁾ + autom.transmission / + scatola cambio automatico / + transmission automatique / + cambio automático

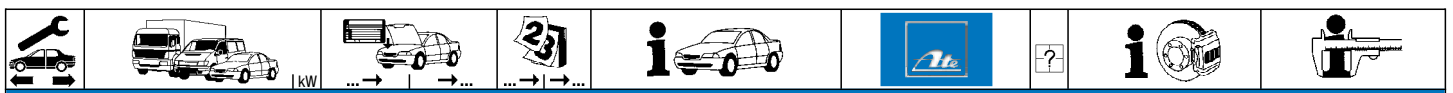

BMW 6er Reihe/E24 (76-89)













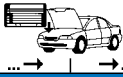



	628 CSI 635 CSI M 635 CSI	135		05.82 05.82 04.84	05.87 04.89 04.89	24.5201-0204.3 83.7704-0200.3	331400 330825	2 2	am Bremsattel ¹⁾	L=204 L=200
	628 CSI 630 CS 633 CSI 635 CSI	135 136		09.79 02.76 01.76 06.78	04.82 08.79 04.82 04.82	03.0137-0149.2	650149			160 x 25
	628 CSI 635 CSI M 635 CSI	135		05.82 05.82 04.84	05.87 04.89 04.89	03.0137-0150.2 03.0137-9062.2	650150 669062			180 x 25 Bremsbacken-Zubehör
	628 CSI 635 CSI M 635 CSI	135		05.82 05.82 04.84	05.87 04.89 04.89	24.3727-0220.2	580220	2 ↓	- Katalysator ²⁾ - Katalysator ²⁾	L=1715
	628 CSI 630 CS 633 CSI 635 CSI	135 136		09.79 02.76 01.76 06.78	04.82 08.79 04.82 04.82	03.2419-9000.3 03.0350-1919.2	030025 071919			Gz 19,05 Gz Reparatursatz
	628 CSI 635 CSI M 635 CSI	135		05.82 05.82 04.84	05.87 04.89 04.89	24.2419-0912.3	030044			Gz 19,05
	628 CSI 630 CS 633 CSI 635 CSI	135 136		09.79 02.76 01.76 06.78	05.87 08.79 04.82 04.89	03.2520-1201.3 03.0450-2006.2	040011 082006			Nz 20,64 Nz Reparatursatz
	628 CSI 635 CSI	135		05.82 05.82	05.87 04.89	24.5905-0320.3	330058		- Rohrleitung ³⁾	L=320
	M 635 CSI			04.84	04.89	24.5802-0320.3	330050		+ Rohrleitung ⁴⁾	L=320

BMW 7er Reihe/E23 (77-86)

	728 728 i 730 732 i 733 i 735 i 745 i	125 135 135 145 145 145 185		04.77 07.78 05.77 05.77 05.77 09.79 04.80	09.79 05.86 08.79 04.86 07.82 04.86 05.86	10.0144-4216.3 10.0504-0113.3 10.0522-4005.1 10.0522-4002.1 10.0515-0515.3	340013 340021 340029 340028 340024			Hydraulik Verstärker DS Regler Warnschalter M10x1 Warnschalter M12x1 Hydraulikspeicher	ATE
	728 728 i 730 732 i 733 i 735 i 745 i	125 135 135 145 145 185		04.77 07.78 05.77 05.77 05.77 09.79 04.80	09.79 05.86 08.79 04.86 07.82 04.86 05.86	03.2122-6912.3	010154		- ABS - ABS - ABS - ABS - ABS - ABS	THz 22,20	ATE
	728 728 i 730 732 i 733 i 735 i 745 i	125 135 135 145 145 185		04.77 07.78 05.77 05.77 05.77 09.79 04.80	09.79 05.86 08.79 04.86 07.82 04.86 05.86	03.2122-7513.3	010155		+ ABS + ABS + ABS + ABS + ABS + ABS	THz 22,20	ATE
	728 728 i 730 732 i 733 i 735 i	125 135 135 145 145		04.77 07.78 05.77 05.77 09.79	09.79 08.82 08.79 08.82 07.82 08.81	13.0441-4018.2	250083			Dichtungssatz	ATE
	728 i 732 i 735 i 745 i	135 145 185		09.82 09.82 09.81 04.80	05.86 05.86 05.86 05.86	13.0441-4018.2	250083			Dichtungssatz	ATE
	728 728 i 730 732 i 733 i 735 i	125 135 135 145 145		04.77 07.78 05.77 05.77 05.77 09.79	09.79 08.82 08.79 04.86 07.82 08.81	13.0460-9031.2 13.0460-0123.2 24.8190-0215.2	609031 610123 620215	1		20437 19,0 /WE Belagsatz-Zubehör Warmkontakt L=162mm	ATE ATE
	728 i 735 i 745 i	135 185		09.82 09.81 04.80	05.86 05.86 05.86	13.0460-9031.2 24.8190-0215.2	609031 620215	1		20437 19,0 /WE Warmkontakt L=162mm	ATE
	728 728 i 730 732 i 733 i 735 i	125 135 135 145 145		04.77 07.78 05.77 05.77 05.77 09.79	09.79 08.82 08.79 08.82 07.82 08.81	24.0122-0111.1	422111			280 22,0 20,4 V	
	728 i 732 i 735 i 745 i	135 145 185		09.82 09.82 09.81 04.80	05.86 05.86 05.86 05.86	24.0125-0100.1	425100			280 25,0 23,4 V L	
	728 728 i 730 732 i 733 i	125 135 135 145 145		04.77 07.78 05.77 05.77 05.77	09.79 05.86 08.79 04.86 07.82	24.5201-0290.3	331401	2		L=290	

1) on the brake caliper / sulla pinza freno / sur l'étrier de frein / a la pinza de freno
 2) - catalytic converter / - catalizzatore / - catalyseur / - catalizador
 3) - pipe line / - tubazione / - conduite rigide / - latiguillo
 4) + pipe line / + tubazione / + conduite rigide / + latiguillo



									
BMW 7er Reihe/E23 (77-86)									
	735 i 745 i	185		09.79 04.80	04.86 05.86	24.5201-0290.3	331401	2	L=290
	728 728 i 730 732 i 733 i 735 i 745 i	125 135 135 145 145 185		04.77 07.78 05.77 05.77 09.79 04.80	09.79 08.81 08.79 08.81 08.81 08.81	13.0441-3303.2	250043		Dichtungssatz ATE
	728 i 732 i 733 i 735 i 745 i	135 145 145 185		09.81 09.81 09.81 09.81	05.86 04.86 07.82 04.86 05.86	11.3331-8501.2 11.3331-8502.2 24.3331-8501.5 24.3331-8502.5 11.0441-3302.2 11.0101-5402.2 11.8171-0008.1 11.8116-0015.1	220004 220005 240509 240510 250004 260009 990049 390492	<input type="checkbox"/> <input type="checkbox"/> <input type="checkbox"/> <input type="checkbox"/> <input type="checkbox"/> <input type="checkbox"/> <input type="checkbox"/> <input type="checkbox"/> <input type="checkbox"/>	D=33, - Halter ATE D=33, - Halter ATE D=33, - Halter ATE D=33, - Halter ATE Dichtungssatz ATE Hülzensatz ATE Führungsbolzen ATE Haltefeder ATE
	728 728 i 730 732 i 733 i 735 i 745 i	125 135 135 145 145 185		04.77 07.78 05.77 05.77 09.79 04.80	09.79 08.81 08.79 08.81 08.81 08.81	24.8190-0215.2	620215	1	Warnkontakt L=162mm
	728 i 732 i 733 i 735 i 745 i	135 145 145 185		09.81 09.81 09.81 09.81	05.86 04.86 07.82 04.86 05.86	13.0460-7047.2 24.8190-0215.2	607047 620215	1	20675 16,5 +/WE ATE Warnkontakt L=162mm
	728 728 i 730 732 i 733 i 735 i 745 i	125 135 135 145 145 185		04.77 07.78 05.77 05.77 09.79 04.80	09.79 08.81 08.79 08.81 08.81 08.81	24.0110-0147.1	410147		280 10,0 8,4
	728 i 732 i 733 i 735 i 745 i	135 145 145 185		09.81 09.81 09.81 09.81	05.86 04.86 07.82 04.86 05.86	24.0110-0176.1	410176		284 10,0 8,4
	728 728 i 730 732 i 733 i 735 i 745 i	125 135 135 145 145 185		04.77 07.78 05.77 05.77 09.79 04.80	09.79 08.81 08.79 08.81 08.81 08.81	24.5201-0204.3	331400	2	L=204
	728 i 732 i 733 i 735 i 745 i	135 145 145 185		09.81 09.81 09.81 09.81	05.86 04.86 07.82 04.86 05.86	24.5201-0204.3 83.7704-0200.3	331400 330825	2 2	am Bremssattel ¹⁾ L=204 L=200
	728 728 i 730 732 i 733 i 735 i 745 i	125 135 135 145 145 185		04.77 07.78 05.77 05.77 09.79 04.80	09.79 08.81 08.79 08.81 08.81 08.81	03.0137-0149.2	650149		160 x 25
	728 i 732 i 733 i 735 i 745 i	135 145 145 185		09.81 09.81 09.81 09.81	05.86 04.86 07.82 04.86 05.86	03.0137-0150.2 03.0137-9062.2	650150 669062		180 x 25 Bremssack-Zubehör
	728 728 i 730 732 i 733 i 735 i 745 i	125 135 135 145 145 185		04.77 07.78 05.77 05.77 09.79 04.80	09.79 08.81 08.79 08.81 08.81 05.86	03.2419-9000.3 03.0350-1919.2	030025 071919		Gz 19,05 Gz Reparatursatz
	728 728 i 730 732 i 733 i 735 i 745 i	125 135 135 145 145 185		04.77 07.78 05.77 05.77 09.79 04.80	09.79 08.81 08.79 08.81 08.81 05.86	03.2522-3601.3	040014		Nz 22,20





















¹⁾ on the brake caliper / sulla pinza freno / sur l'étrier de frein / a la pinza de freno











































BMW 7er Reihe/E32 (86-94)

	730 i 6		07.86	02.88	10.0144-4234.3	340014		Hydraulik Verstärker DS Regler Warnschalter M10x1 Warnschalter M12x1 Hydraulikspeicher	ATE						
	730 iL 6		12.87	02.88	10.0504-0113.3	340021									
	735 i		09.86	02.88	10.0522-4005.1	340029									
	735 iL		09.86	02.88	10.0522-4002.1	340028									
					10.0515-0515.3	340024									
					10.0522-4005.1	340029									
	750 i	220	07.87	11.90	10.0522-4005.1	340029		Warnschalter M10x1 Warnschalter M12x1	ATE						
	750 iL	220	11.86	11.90	10.0522-4002.1	340028									
	750 i	220	12.90	06.94	10.0522-4005.1	340029									
	750 iL	220	12.90	06.94	10.0522-4002.1	340028									
					10.0515-9002.3	340026									
					10.0515-9002.3	340026									
	730 i 6		07.86	02.88	03.2125-2802.3	010210		THz 25,40	ATE						
	730 iL 6		12.87	02.88											
	735 i		09.86	02.88											
	735 iL		09.86	02.88											
	750 i	220	07.87	06.94											
	750 iL	220	11.86	06.94											
	730 i 6		03.88	06.94						03.2125-3011.3	010211	+ Unterdruckverstärker ¹⁾	THz 25,40	ATE	
	730 iL 6		03.88	06.94											
	735 i		03.88	09.92											
	735 iL		03.88	09.92											
	730 i 8	160	03.91	06.94						24.2125-1716.3	010663	+ Unterdruckverstärker ¹⁾	THz 25,40	ATE	
	730 iL 8	160	06.92	06.94											
740 i	210	09.91	06.94												
740 iL	210	10.91	06.94												
740 iL	210	10.91	06.94												
	730 i 6		07.86	10.87	24.3601-8503.5	240535	2	D=60, - Halter D=60, - Halter Dichtungssatz Hülssensatz Führungsbolzen Haltefeder	ATE ATE ATE ATE ATE ATE						
	730 iL 6		12.87	06.94											
	735 i		09.86	09.92											
	735 iL		09.86	09.92											
	740 i	210	09.91	06.94											
	740 iL	210	10.91	06.94											
	750 i	220	07.87	12.89											
	750 i	220	01.90	06.94											
	750 iL	220	11.86	12.89											
	750 iL	220	01.90	06.94											
	730 i 6		11.87	06.94						11.3601-8505.2	220149		D=60, - Halter D=60, - Halter D=60, - Halter Dichtungssatz Hülssensatz Führungsbolzen Haltefeder	ATE ATE ATE ATE ATE ATE	
	730 i 8	160	03.91	06.94											
730 iL 8	160	06.92	06.94												
	730 i 6		07.86	06.94	13.0460-6033.2	606033	1	20968 20,3 +/-WE Warnkontakt L=235mm	ATE						
	730 i 8	160	03.91	06.94											
	730 iL 6		12.87	06.94											
	730 iL 8	160	06.92	06.94											
	735 i		09.86	09.92											
	735 iL		09.86	09.92											
	740 i	210	09.91	06.94											
	740 iL	210	10.91	06.94											
	750 i	220	07.87	12.89											
	750 i	220	01.90	06.94											
	750 iL	220	11.86	12.89											
	750 iL	220	01.90	06.94											
	750 i	220	01.90	06.94	13.0460-9037.2	609037	1	20309 17,9 /WE Warnkontakt L=235mm	ATE						
	750 iL	220	01.90	06.94											
	730 i 6		07.86	10.87	24.0128-0101.1	428101		302 28,0 26,4 V L + B	ATE						
	730 iL 6		12.87	06.94											
	735 i		09.86	09.92											
	735 iL		09.86	09.92											
740 i	210	09.91	06.94												
740 iL	210	10.91	06.94												
750 i	220	07.87	12.89												
750 i	220	01.90	06.94												
750 iL	220	11.86	12.89												
750 iL	220	01.90	06.94												
	730 i 6		11.87	06.94						24.0122-0103.1	422103		302 22,0 20,4 V L + S + B	ATE	
	730 i 8	160	03.91	06.94											
	730 iL 8	160	06.92	06.94	24.0322-0103.1	522103		302 22,0 19,6 V L + S + B PD	ATE						
	750 i	220	01.90	06.94											
	750 iL	220	01.90	06.94	24.0130-0101.1	430101		324 30,0 28,4 V L + S + B	ATE						
	750 iL	220	01.90	06.94											
	730 i 6		07.86	06.94	24.5113-0423.3	331396	2	L=423	ATE						
	730 i 8	160	03.91	06.94											
	730 iL 6		12.87	06.94											
	730 iL 8	160	06.92	06.94											
	735 i		09.86	09.92											
	735 iL		09.86	09.92											
	740 i	210	09.91	06.94											
	740 iL	210	10.91	06.94											
	750 i	220	07.87	06.94											
	750 iL	220	11.86	06.94											
		730 i 6		07.86						10.87	11.3381-8501.2	220018	2	D=38, - Halter Dichtungssatz Hülssensatz Führungsbolzen Haltefeder	ATE ATE ATE ATE ATE
		730 iL 6		12.87						06.94					
735 i			09.86	09.92											
735 iL			09.86	09.92											
735 iL			09.86	09.92											







¹⁾ + vacuum booster / + servofreno a depressione / + amplificateur à dépression / + amplificador de depresión
²⁾ - ⊕ / + fist type calipers / - ⊕ / + pinze flottanti / - ⊕ / + étriers à griffe / - ⊕ / + pinza de puno
³⁾ + ⊕ / + fixed calipers / + ⊕ / + pinze freno fissa / + ⊕ / + étriers fixes / + ⊕ / + pinza de fija

											
BMW 7er Reihe/E32 (86-94)											
	730 i 6		11.87	06.94	11.3381-8504.2	220021	2	D=38, - Halter ATE D=38, - Halter ATE Dichtungssatz ATE Hülzensatz ATE Führungsbolzen ATE Haltefeder ATE			
	730 i 8	160	03.91	06.94	24.3381-8503.5	240515					
	730 iL 8	160	06.92	06.94	24.3381-8504.5	240516					
					11.0441-3803.2	250010					
					11.0101-5402.2	260009					
					11.8171-0008.1	990049					
					11.8116-0066.1	390577					
	750 i	220	07.87	12.89	11.0441-3802.2	250009					
	750 iL	220	11.86	12.89	11.0101-5402.2	260009					
					11.8171-0008.1	990049					
					11.8116-0066.1	390577					
		730 i 6		07.86	06.94	13.0460-3803.2			603803	1	20995 17,3 +/-WE Warnkontakt L=235mm ATE
730 i 8		160	03.91	06.94	24.8190-0214.2	620214					
730 iL 6			12.87	06.94							
730 iL 8		160	06.92	06.94							
735 i			09.86	09.92							
735 iL			09.86	09.92							
740 i		210	09.91	06.94							
740 iL		210	10.91	06.94							
750 i		220	07.87	06.94							
750 iL		220	11.86	06.94							
		730 i 6		07.86	10.87	24.0112-0120.1	412120		300 12,0 10,4 L		
		730 iL 6		12.87	06.94						
	735 i		09.86	09.92							
	735 iL		09.86	09.92							
	730 i 6		11.87	06.94	24.0110-0118.1	410118					
	730 i 8	160	03.91	06.94							
	730 iL 8	160	06.92	06.94							
	740 i	210	09.91	06.94	24.0120-0113.1	420113					
	740 iL	210	10.91	06.94							
	750 i	220	07.87	06.94							
	750 iL	220	11.86	06.94							
		730 i 6		07.86	06.94	24.5201-0204.3	331400			2 2	am Bremssattel 1)
730 i 8		160	03.91	06.94	83.7704-0200.3	330825					
730 iL 6			12.87	06.94							
730 iL 8		160	06.92	06.94							
735 i			09.86	09.92							
735 iL			09.86	09.92							
740 i		210	09.91	06.94							
740 iL		210	10.91	06.94							
750 i		220	07.87	06.94							
750 iL		220	11.86	06.94							
		730 i 6		07.86	06.94	03.0137-0150.2	650150		180 x 25 Bremsbacken-Zubehör		
		730 i 8	160	03.91	06.94	03.0137-9062.2	669062				
	730 iL 6		12.87	06.94							
	730 iL 8	160	06.92	06.94							
	735 i		09.86	09.92							
	735 iL		09.86	09.92							
	740 i	210	09.91	06.94							
	740 iL	210	10.91	06.94							
	750 i	220	07.87	06.94							
	750 iL	220	11.86	06.94							
		730 i 6		07.86	06.94	24.3727-0219.2	580219			2	L=1855
		730 i 8	160	03.91	06.94						
735 i			09.86	09.92							
740 i		210	09.91	06.94							
750 i		220	07.87	06.94							
	730 i 6		07.86	06.94	24.2419-0922.3	030051		Gz 19,05			
	730 i 8	160	03.91	06.94							
	730 iL 6		12.87	06.94							
	730 iL 8	160	06.92	06.94							
	735 iL		09.86	09.92							
	730 i 6		07.86	06.94	03.2522-3601.3	040014		Nz 22,20			
	730 iL 6		12.87	06.94							
	735 i		09.86	09.92							
	735 iL		09.86	09.92							
	730 i 8	160	03.91	06.94	24.2522-0905.3	040042		Nz 22,20			
	730 iL 8	160	06.92	06.94							
	730 i 6		07.86	06.94	24.5905-0320.3	330058		L=320			
	730 iL 6		12.87	06.94							
	735 i		09.86	09.92							
	735 iL		09.86	09.92							
BMW M1 (79-83)											
	M1		05.79	05.83	13.0460-9031.2	609031		20437 19,0 /WE ATE			
	M1		05.79	05.83	13.0460-5032.2	605032		20588 16,5 /WE ATE			

1) on the brake caliper / sulla pinza freno / sur l'étrier de frein / a la pinza de freno

												
BMW Z1 (88-91)												
	2.5	125		07.88	06.91		03.7760-0902.4	300088	10"	ATE		
	2.5	125		07.88	06.91		03.2022-1201.3	010009	Thz 22,20/17,46	ATE		
	2.5	125		07.88	06.91		24.3481-1607.5 24.3481-1608.5 11.0441-4810.2 11.0101-5402.2 11.8171-0008.1	240211 240212 250023 260009 990049	 	D=48, - Halter D=48, - Halter Dichtungssatz Hülzensatz Führungsbolzen	LUC LUC ATE ATE ATE	
	2.5	125		07.88	06.91		13.0460-2921.2 24.8190-0201.2	602921 620201	1	21173 17,0 /WE/S Warnkontakt L=235mm	LUC	
	2.5	125		07.88	06.91		24.0122-0122.1 24.0322-0122.1	422122 522122		260 22,0 20,4 V L +B 260 22,0 19,6 V L +B PD		
	2.5	125		07.88	06.91		24.5102-0304.3	331407	2	L=304		
	2.5	125		07.88	08.90		11.0441-3602.2 11.0101-5402.2 11.8171-0008.1 11.8116-0066.1	250008 260009 990049 390577	2	Dichtungssatz Hülzensatz Führungsbolzen Haltefeder	ATE ATE ATE ATE	
	2.5	125		09.90	06.91		11.3361-8503.2 11.3361-8504.2 24.3361-8503.5 24.3361-8504.5 11.0441-3602.2 11.0101-5402.2 11.8171-0008.1 11.8116-0066.1	220016 220017 240513 240514 250008 260009 990049 390577	    	D=36, - Halter D=36, - Halter D=36, - Halter D=36, - Halter Dichtungssatz Hülzensatz Führungsbolzen Haltefeder	ATE ATE ATE ATE ATE ATE ATE ATE	
	2.5	125		07.88	08.90		13.0460-3803.2 24.8190-0213.2	603803 620213	1	20995 17,3 +/-WE Warnkontakt L=262mm	ATE	
	2.5	125		09.90	06.91		13.0460-3605.2 13.0470-3605.2 24.8190-0213.2	603605 LD3605 620213	1	20180 17,3 +/-WE 20180 17,3 +/-WE Warnkontakt L=262mm	ATE ATE	
	2.5	125		07.88	08.90		83.6104-0245.3	330525	2	L=245		
	2.5	125		09.90	06.91		83.6204-0300.3 83.7704-0200.3	330548 330825	2 2	L=300 L=200 am Bremssattel ¹⁾		
	2.5	125		07.88	08.90		03.0137-0149.2 03.0137-9062.2	650149 669062		160 x 25 Bremssack-Zubehör		
	2.5	125		09.90	06.91		03.0137-0248.2 03.0137-9148.2	650248 669148		161 x 25 Bremssack-Zubehör		
	2.5	125		07.88	06.91		03.6045-0620.3	320040		BRE 5/25	ATE	
	2.5	125		07.88	06.91		24.2419-0922.3	030051		Gz 19,05		
	2.5	125		07.88	06.91		03.2520-1201.3 03.0450-2006.2	040011 082006		Nz 20,64 Nz Reparatursatz		
	2.5	125		07.88	06.91		24.5802-0320.3	330050		+ Rohrleitung ²⁾	L=320	
BÜSSING BUS BS 100 - BS 180												
	BS 113 N			01.69	12.72		03.3134-0300.3 03.3138-2001.3 03.0370-1038.2 03.0370-9998.2	010308 010310 051038 059998		+ Vorderachse ³⁾ + Hinterachse ⁴⁾ + Hinterachse ⁴⁾ + 1. Hinterachse ⁵⁾	Hz 34,92 Hz 38,10 Hz Reparatursatz Hz Rep. Satz, -Kolben	ATE ATE ATE ATE
	BS 110 N/T/GT BS 120 GT BS 120 V/N BS 170 V/N BS 180 V/N			01.69 01.71 01.69 01.69 01.69	12.72 12.72 12.72 12.72 12.72		03.3134-0300.3	010308	2		Hz 34,92	ATE
BÜSSING BUS KONSUL												
	11			01.62	12.62		83.6103-0320.3	330224			L=320	
BÜSSING BUS PRÄFEKT												
	17/19 Trambus 25/26 Doppeldecker			01.66 01.66	12.67 12.71		03.3138-2001.3 03.0370-1131.2 03.0370-1038.2 03.0370-9998.2	010310 051131 051038 059998		+ Hinterachse ⁴⁾ + Vorderachse ³⁾ + Hinterachse ⁴⁾ + Hinterachse ⁴⁾	Hz 38,10 Hz Reparatursatz Hz Reparatursatz Hz Rep. Satz, -Kolben	ATE ATE ATE ATE
	26 Doppeldecker			01.68	12.68		03.3134-0300.3 03.3138-2001.3 03.0370-1038.2 03.0370-9998.2	010308 010310 051038 059998		+ Vorderachse ³⁾ + Hinterachse ⁴⁾ + Hinterachse ⁴⁾ + Hinterachse ⁴⁾	Hz 34,92 Hz 38,10 Hz Reparatursatz Hz Rep. Satz, -Kolben	ATE ATE ATE ATE
	13 Standard			01.68	12.68		03.3138-2001.3 03.0370-1038.2 03.0370-9998.2	010310 051038 059998	2		Hz 38,10 Hz Reparatursatz Hz Rep. Satz, -Kolben	ATE ATE ATE















¹⁾ on the brake caliper / sulla pinza freno / sur l'étrier de frein / a la pinza de freno
²⁾ + pipe line / + tubazione / + conduite rigide / + latiguillo
³⁾ + front axle / + asse anteriore / + essieu avant / + eje delantero
⁴⁾ + rear axle / + asse posteriore / + essieu arrière / + eje trasero
⁵⁾ + 1. rear axle / + 1. asse posteriore / + 1. essieu arrière / + 1. eje trasero

BÜSSING BUS PRÄFEKT												
	13 VÖV			01.67	12.67		03.3134-0300.3	010308	2		Hz 34,92	ATE
	alle Typen			01.65	08.68		83.6103-0320.3	330224			L=320	
BÜSSING BUS PRÄSIDENT												
	alle Typen			01.61	08.68		83.6103-0320.3	330224			L=320	
BÜSSING BUS SENATOR												
	alle Typen			01.61	12.65		83.6103-0320.3	330224			L=320	
BÜSSING BUS TU 5 - TU 11												
	TU 5			01.65	12.66		03.3150-0101.3	010321	2		Hz 50,80	ATE
BÜSSING LKW BS 09 - BS 22												
	BS 12 A/FSA	114		09.69	08.70		03.3138-2001.3	010310			Hz 38,10	ATE
	BS 12 L	114		09.69	08.71		03.0370-1038.2	051038			Hz Reparatursatz	ATE
	BS 12 L	141		09.71	08.72		03.0370-9998.2	059998			Hz Rep. Satz, -Kolben	ATE
	BS 13 A/FSA			09.69	08.70		03.3138-2001.3	010310		+ Hinterachse ¹⁾	Hz 38,10	ATE
	BS 13 L			09.68	08.72		03.0370-1038.2	051038			Hz Reparatursatz	ATE
							03.0370-9998.2	059998			Hz Rep. Satz, -Kolben	ATE
	BS 14 A/FSA			09.68	08.70		03.0370-1131.2	051131			Hz Reparatursatz	
	BS 14 L			09.68	08.72							
	BS 15 L			09.68	08.72							
	BS 15 A/FSA			09.69	08.70		03.3134-0300.3	010308		+ Vorderachse ²⁾	Hz 34,92	ATE
	BS 15 AK			09.68	08.70		03.0370-1131.2	051131		+ Hinterachse ¹⁾	Hz Reparatursatz	
	BS 16 L			09.67	08.72		03.3138-2001.3	010310		+ Hinterachse ¹⁾	Hz 38,10	ATE
BS 16 UK			09.69	08.70		03.0370-1131.2	051131		+ Vorderachse ²⁾	Hz Reparatursatz	ATE	
						03.0370-1038.2	051038		+ Hinterachse ¹⁾	Hz Reparatursatz	ATE	
						03.0370-9998.2	059998		+ Hinterachse ¹⁾	Hz Rep. Satz, -Kolben	ATE	
BS 16 B/SK			09.69	08.71		03.0370-1131.2	051131			Hz Reparatursatz		
BS 16 S			09.67	08.72								
BS 16 SBB/SBL			09.68	08.71								
BS 19 A/SK			09.69	08.70								
BS 19 B/BB/BL			09.69	08.71								
BS 19 L/K			09.68	08.70								
BS 19 S			09.67	08.72								
BS 19 SBB/SML			09.68	08.69								
BS 20 S2			09.69	08.72		03.3138-2001.3	010310	3		Hz 38,10	ATE	
						03.0370-1038.2	051038			Hz Reparatursatz	ATE	
						03.0370-9998.2	059998			Hz Rep. Satz, -Kolben	ATE	
BS 22 B			09.69	08.71		03.3138-2001.3	010310		+ 1. Hinterachse ³⁾	Hz 38,10	ATE	
BS 22 BB/BL			09.70	08.71		03.0370-1131.2	051131		+ Vorderachse ²⁾	Hz Reparatursatz	ATE	
BS 22 K/S			09.70	08.72		03.0370-1038.2	051038		+ 1. Hinterachse ³⁾	Hz Reparatursatz	ATE	
BS 22 L			09.68	08.72		03.0370-9998.2	059998		+ 1. Hinterachse ³⁾	Hz Rep. Satz, -Kolben	ATE	
	BS 12 A			09.69	08.70		83.6103-0260.3	330221			L=260	
	BS 12 FSA			09.68	08.70							
	BS 12 L			09.68	08.70							
	BS 13 A/FSA			09.69	08.70							
	BS 13 L			09.68	08.72							
	BS 14 A			09.69	08.70							
	BS 14 FSA			09.67	08.70							
	BS 14 K/AK			09.67	08.68							
	BS 14 L			09.67	08.72							
	BS 15 A/FSA			09.69	08.70							
	BS 15 AK			09.68	08.70							
	BS 15 L			09.68	08.72							
	BS 16 B/BB/SBB/SK	159		09.69	08.71							
	BS 16 B/BB/SBB/SK	176		09.69	08.71							
	BS 16 BL/SBL	159		09.68	08.71							
	BS 16 BL/SBL	176		09.68	08.71							
	BS 16 L/S	159		09.67	08.72							
	BS 16 L/S	176		09.67	08.72							
	BS 16 SK	159		09.69	08.72							
	BS 16 SK	176		09.69	08.72							
	BS 19 A/SK			09.69	08.70							
	BS 19 B/BB/BL			09.69	08.71							
	BS 19 K/L/SBB/SBL			09.68	08.70							
	BS 19 S			09.67	08.72							
	BS 20 S2			09.69	08.72							
	BS 22 B			09.69	08.71							
	BS 22 BB/BL			09.70	08.71							
	BS 22 K/S			09.70	08.72							
	BS 22 L			09.68	08.72							
	BS 26 K			09.70	08.72							
	BS 32 K			09.70	08.72							

¹⁾ + rear axle / + asse posteriore / + essieu arrière / + eje trasero

²⁾ + front axle / + asse anteriore / + essieu avant / + eje delantero

³⁾ + 1. rear axle / + 1. asse posteriore / + 1. essieu arrière / + 1. eje trasero

BÜSSING LKW COMMODORE											
	F LS11/16 FK3 FS3 K LS11/16 LU11/16 S LS11/16 U/UK			01.62 09.63 09.63 01.61 01.62 01.61 08.63	08.63 08.65 08.65 08.63 08.63 08.63 08.68			03.3150-0101.3	010321		Hz 50,80 ATE
	AK LS11/16 FS/SS SA LS11/16 SAK SS Export			01.62 09.63 01.62 09.63 09.65 09.63	08.63 08.65 08.63 08.63 08.67 08.67			03.3150-0101.3	010321	2	Hz 50,80 ATE
								03.0370-1131.2	051131		Hz Reparatursatz
				09.63	08.67			03.3150-0101.3	010321	+ Hinterachse 1)	Hz 50,80 ATE
	AK LS11/16 F LS11/16 FK3 FS/SS FS3 K LS11/16 LU11/16 S LS11/16 SA LS11/16 SAK U/UK			01.62 01.62 09.63 09.63 09.63 01.61 01.62 01.61 01.62 09.63 08.63	08.63 08.63 08.65 08.65 08.65 08.63 08.63 08.63 08.63 08.68 08.68			03.3508-0501.3	310017		Behälter
BÜSSING LKW LS7/LU7 - LS77/LU77											
	LS 11/F LU 11/A			01.55 01.55	12.62 12.62			03.3150-0101.3	010321		Hz 50,80 ATE
	LS 75/77 LU 75/77			01.60 01.60	12.62 12.62			03.0370-1131.2	051131		Hz Reparatursatz
	LS 11/F LU 11/A			01.55 01.55	12.62 12.62			03.3508-0501.3	310017		Behälter
	LS 55 LU 55			01.60 01.60	12.60 12.60			03.3508-0501.3	310017		Behälter
	LS 75/77			01.59	12.59			03.3508-0501.3	310017		Behälter
	LS 75/77 LU 75/77			01.60 01.60	12.62 12.62			03.3508-0401.3	310014		Behälter
	LS 77 F			01.61	12.61			03.3508-0501.3	310017		Behälter
	LS 11 LU 11			01.55 01.55	12.57 12.57			83.6103-0500.3	330230		L=500
	LS 11 LU 11			01.55 01.55	12.57 12.57			83.6103-0600.3	330233		L=600
BÜSSING LKW SUPERCARGO											
	AK SK/SAK			09.64 09.63	08.66 08.64			03.3150-0101.3	010321		Hz 50,80 ATE
	AK LU 7/14 S Export SK/SAK U/UK/US			09.65 01.61 09.63 09.63 09.63	08.66 08.63 08.66 08.64 08.66			83.6103-0260.3	330221		L=260
BÜSSING LKW 6000-8000											
	6000 S8 7500 S/SU 8000/S			01.59 01.54 01.50	12.60 12.55 12.55			03.3150-0101.3	010321		Hz 50,80 ATE
	6000 S8 7500 S/SU 8000/S			01.59 01.54 01.50	12.60 12.55 12.55			03.3508-0501.3	310017		Behälter
	6000 S8 7500 S			01.59 01.54	12.60 12.55			83.6103-0700.3	330236		L=700
	7500 SU 8000/S			01.54 01.50	12.55 12.55			83.6103-0500.3	330230		L=500
	7500 SU 8000/S			01.54 01.50	12.55 12.55			83.6103-0600.3	330233		L=600
	6000 S8 7500 S/SU 8000/S			01.59 01.54 01.50	12.60 12.55 12.55			83.6103-0500.3	330230		L=500
CHRYSLER VOYAGER (ES) (90-95)											
	2.5 i 2.5 TD 3.0 i 3.3 i 3.3 i 3.3 i AWD	110 120		08.90 01.92 10.90 08.90 08.90 08.90	12.95 + 15" Rad 2) 12.95 + 15" Rad 2) 12.95 + 15" Rad 2) 12.95 + 15" Rad 2) 12.95 + 15" Rad 2) 12.95 + 15" Rad 2)			13.0460-8009.2	608009		21815 18,8 +WK
	2.5 i 2.5 TD 3.0 i 3.3 i 3.3 i 3.3 i AWD	110 120		08.90 01.92 10.90 08.90 08.90 08.90	12.95 + 15" Rad 2) 12.95 + 15" Rad 2) 12.95 + 15" Rad 2) 12.95 + 15" Rad 2) 12.95 + 15" Rad 2) 12.95 + 15" Rad 2)			24.0124-0193.1	424193		283 24,0 22,4 V

1) + rear axle / + asse posteriore / + essieu arrière / + eje trasero

2) + 15" wheel / + ruota 15" / + roue 15" / + rueda 15"

CITROEN 2CV (63-90)		kW		
	4 6 6 Charleston 6 Club 6 Special					07.76 07.76 10.80 07.76 07.79	06.79 06.79			24.2120-1502.3	010405							THz 20,64	
	6 Charleston 6 Club 6 Special	ORGA 01666 ORGA 01666 ORGA 01666				12.90 12.90 12.90				13.0460-4906.2 13.0460-4910.2	604906 604910		+ Handbremse ¹⁾				20207 12,0 20285 7,1	CIT CIT	
	6 Charleston 6 Club 6 Special	ORGA 01666 ORGA 01666 ORGA 01666				12.90 12.90 12.90				24.0107-0100.1	407100						244 7,0 6,3		
	4 4 6 Charleston 6 Club 6 Special AK 400 Fourgonnette					03.70 07.70 10.80 07.76 07.79 07.70 08.78	06.70			24.3228-1102.3 24.3228-1101.3	020347 020297						Rz 28,57 Rz 28,57		
	4 6 6 Charleston 6 Club 6 Special					07.70 07.70 10.80 07.79 07.76	06.79 06.79			03.0420-0228.3	680228						28,57/200x36 Kit	CIT	
	4 6 6 Charleston 6 Club 6 Special					07.70 07.70 10.80 07.79 07.76	06.79 06.79			24.3217-1101.3	020309						Rz 17,46		
	6 Charleston 6 Club 6 Special	ORGA 01665 ORGA 01666 ORGA 01666				12.90 12.90 12.90				24.3215-1602.3	020355						Rz 15,87		
	4 6 6 Charleston 6 Club 6 Special AK 400 Fourgonnette					03.70 03.70 10.80 07.79 07.76 06.70 08.78	06.79 06.79			03.0137-0092.2 03.0137-9070.2	650092 669070						180 x 34 Bremsbacken-Zubehör	BDX BDX	
CITROEN ACADIANE (78-85)																			
	0.6					08.78	12.85			24.0107-0100.1	407100						244 7,0 6,3		
	0.6					08.78	12.85			03.0137-0092.2 03.0137-9070.2	650092 669070						180 x 34 Bremsbacken-Zubehör	BDX BDX	
CITROEN AMI 8 (69-78)																			
	0.6					08.69	12.78			24.0107-0100.1	407100						244 7,0 6,3		
	0.6					08.69	12.78			24.3215-1602.3	020355						Rz 15,87		
	0.6 1.0 Super					08.69 01.73	12.78 12.77			03.0137-0092.2 03.0137-9070.2	650092 669070						180 x 34 Bremsbacken-Zubehör	BDX BDX	
CITROEN BX (82-93)																			
	1.4 1.4 1.6 1.9 4X4 1.9 D 11 14 15 16 18 D 18 TRD 19 19 19 19 19 4x4 19 D 19 D 19 E 19 GTi 19 GTi 19 GTi 16V 19 GTi 16V	44 52 85 92 52 59 44 66 70 75 77 78 47 51 80 88 90 108 116				01.87 01.87 01.87 02.92 01.87 10.86 09.82 10.87 09.82 10.85 09.88 02.88 09.85 10.84 06.89 09.82 09.87 02.88 09.88 06.86 09.88 09.87	01.92 01.92 01.92 06.94 01.92 06.92 12.93 05.92 12.93 09.93 12.93 12.93 12.93 08.85 05.91 08.87 12.93 12.93 12.93 08.88 08.88			13.0460-3915.2 13.0460-0403.2	603915 610403						20635 18,0 +/WK Belagsatz-Zubehör	BDX BDX	
	1.4 1.4 1.6 1.9 4X4 1.9 D 11 ↓	44 52 85 92 52				01.87 01.87 01.87 02.92 01.87 10.86	01.92 01.92 01.92 06.94 01.92 06.92			24.0110-0183.1	410183						266 10,0 8,0		

¹⁾ + parking brake / + freno di stationamento / + frein à main / + freno de mano



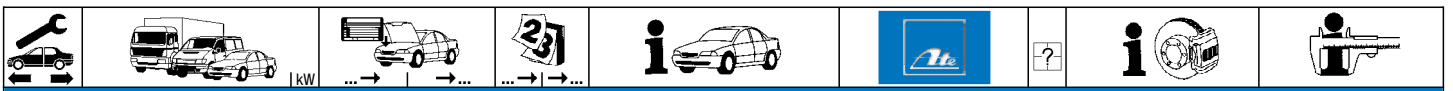

CITROEN BX (82-93)

	14 15 16 18 D 18 TRD 19 19 19 19 4x4 19 D 19 D 19 E 19 GTi 19 GTi	59 44 66 70 75 77 78 47 51 80 88 90		09.82 10.87 09.82 10.85 09.88 02.88 09.85 10.84 06.89 09.82 09.87 02.88 09.88 06.86	12.93 05.92 12.93 09.93 12.93 12.93 08.85 05.91 08.87 12.93 12.93 08.88	24.0110-0183.1	410183		266 10,0 8,0	
	19 GTi 16V 19 GTi 16V	108 116		09.88 09.87	12.93 08.88	24.0120-0133.1 24.0320-0133.1	420133 520133		266 20,5 18,5 V +S +B 266 20,5 18,5 V +S +B PD	
	1.4 1.4 1.6 1.9 4X4 1.9 D 11 14 15 16 18 D 18 TRD 19 19 19 19 4x4 19 D 19 D 19 E 19 GTi 19 GTi	44 52 85 92 52 52 59 44 66 70 75 77 78 47 51 80 88 90		01.87 01.87 01.87 02.92 01.87 10.86 09.82 10.87 09.82 10.85 09.88 02.88 09.85 10.84 06.89 09.82 09.87 02.88 09.88 06.86	01.92 01.92 01.92 06.94 01.92 06.92 12.93 05.92 12.93 09.93 12.93 12.93 12.93 08.85 05.91 08.87 12.93 12.93 12.93 08.88	- ABS - ABS - ABS - ABS - ABS - ABS - ABS - ABS - ABS - ABS - ABS - ABS - ABS - ABS - ABS - ABS - ABS - ABS - ABS - ABS	24.5119-0435.3	330472	2	L=430
	1.4 1.4 1.6 1.9 D 11 14 15 16 18 D 18 TRD 19 19 19 19 4x4 19 D 19 D 19 E 19 GTi 19 GTi 19 GTi 16V 19 GTi 16V	44 52 85 52 52 59 44 66 70 75 77 78 47 51 80 88 90 108 116		01.87 01.87 01.87 01.87 10.86 09.86 10.87 09.86 10.85 09.86 02.88 09.86 09.86 09.86 06.89 09.86 09.87 02.88 09.88 09.86 09.88 09.87	01.92 01.92 01.92 01.92 06.92 12.93 05.92 12.93 09.93 12.93 12.93 12.93 12.93 05.91 08.87 12.93 12.93 12.93 12.93 08.88 12.93 08.88	+ ABS + ABS + ABS + ABS + ABS + ABS + ABS + ABS + ABS + ABS + ABS + ABS + ABS + ABS + ABS + ABS + ABS + ABS + ABS + ABS	24.5120-0435.3	330488	2	L=430
	1.4 1.4 1.6 1.9 4X4 1.9 D 11 14 15 16 18 D 18 TRD 19 19 19 19 4x4 19 D 19 D 19 E 19 GTi 19 GTi 19 GTi 16V 19 GTi 16V	44 52 85 92 52 52 59 44 66 70 75 77 78 47 51 80 88 90 108 116		01.87 01.87 01.87 02.92 01.87 10.86 09.82 10.87 09.82 10.85 09.88 02.88 09.85 10.84 06.89 09.82 09.87 02.88 09.88 06.86 09.88 09.87	01.92 01.92 01.92 06.94 01.92 06.92 12.93 05.92 12.93 09.93 12.93 12.93 12.93 08.85 05.91 08.87 12.93 12.93 12.93 08.88 12.93 08.88		24.0107-0105.2	407105		224 7,0 5,0
	1.4 1.4 1.6 1.9 4X4 1.9 D 11 14 15 16	44 52 85 92 52 52 59		01.87 01.87 01.87 02.92 01.87 10.86 11.82 10.87 11.82	01.92 01.92 01.92 06.94 01.92 06.92 12.93 05.92 12.93		24.3727-0310.2	580310	2 ↓	L=1651

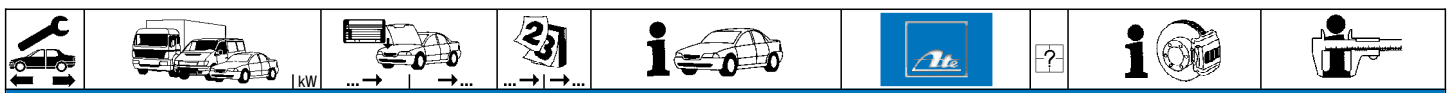

CITROEN BX (82-93)

	18 D	44	10.85	09.93	24.3727-0310.2	580310	2 ↓	L=1651
	18 TRD	66	09.88	12.93				
	19	70	02.88	12.93				
	19	75	09.85	12.93				
	19	77	10.84	08.85				
	19 4x4	78	06.89	05.91				
	19 D	47	11.82	08.87				
	19 D	51	09.87	12.93				
	19 E	80	02.88	12.93				
	19 GTi	88	09.88	12.93				
	19 GTi	90	06.86	08.88				
	19 GTi 16V	108	09.88	12.93				
	19 GTi 16V	116	09.87	08.88				
	1.4	44	01.87	01.92	24.3728-0304.2	590304		L=674
	1.4	52	01.87	01.92				
	1.6	85	01.87	01.92				
	1.9 4X4	92	02.92	06.94				
	1.9 D	52	01.87	01.92				
	16		09.82	12.93				
	18 D	44	10.85	09.93				
	19	70	02.88	12.93				
	19	75	09.85	12.93				
	19	77	10.84	08.85				
	19 D	47	09.82	08.87				
	19 D	51	09.87	12.93				
	19 E	80	02.88	12.93				
	19 GTi	88	09.88	12.93				
	19 GTi	90	06.86	08.88				





















CITROEN CX I Limousine (74-85)

	2000	75	07.74	05.79	13.0460-4900.2	604900	+ Handbremse ¹⁾	20371 8,1	CIT
	2000	78	06.79	05.80					
	2200	82	09.74	07.76					
	2200 D	49	10.75	02.79					
	2400	85	08.76	05.80					
	2400 GTi	94	06.77	05.80					
	2400 GTi	96	06.77	05.80					
	2500 D	55	02.78	05.80					
	2000	78	06.80	08.85	13.0460-4900.2	604900	+ Handbremse ¹⁾	20371 8,1	CIT
	2200	85	06.81	08.85	13.0460-0408.2	610408		Belagsatz-Zubehör	CIT
	2400	88	06.80	05.82					
	2400 GTi	94	06.80	06.82					
	2400 GTi	96	06.80	06.82					
	2500 D	55	06.80	06.82					
	2500 D Turbo	70	04.83	08.85					
	2500 GTi Turbo 2	122	06.84	08.85					
	2500 TRi	100	07.83	08.85					
	2000	75	07.74	05.79	24.0120-0108.1	420108		260 20,0 18,0 V	
	2000	78	06.79	08.85					
	2200	82	09.74	07.76					
	2200	85	06.81	08.85					
	2200 D	49	10.75	02.79					
	2400	85	08.76	05.80					
	2400	88	06.80	05.82					
	2400 GTi	94	06.77	06.82					
	2400 GTi	96	06.77	06.82					
	2500 D	55	02.78	06.82					
	2500 D Turbo	70	04.83	08.85					
	2500 GTi Turbo 2	122	06.84	08.85					
	2500 TRi	100	07.83	08.85					

CITROEN CX I Kombi (75-85)

	2000	75	09.75	05.79	13.0460-4900.2	604900	+ Handbremse ¹⁾	20371 8,1	CIT
	2000	78	06.79	05.80					
	2200 D	49	08.76	02.79					
	2400	85	08.78	05.80					
	2500 D	55	02.78	05.80					
	2000	78	06.80	08.85	13.0460-4900.2	604900	+ Handbremse ¹⁾	20371 8,1	CIT
	2200	85	06.81	08.85	13.0460-0408.2	610408		Belagsatz-Zubehör	CIT
	2400	88	06.80	05.82					
	2400 GTi	94	07.82	06.83					
	2500 D	55	06.80	08.85					
	2500 D Turbo	70	04.83	08.85					
	2500 TRi	100	07.83	08.85					
	2000	75	09.75	05.79	24.0120-0108.1	420108		260 20,0 18,0 V	
	2000	78	06.79	08.85					
	2200	85	06.81	08.85					
	2200 D	49	08.76	02.79					
	2400	85	08.78	05.80					
	2400	88	06.80	05.82					
	2400 GTi	94	07.82	06.83					
	2500 D	55	02.78	08.85					
	2500 D Turbo	70	04.83	08.85					
	2500 TRi	100	07.83	08.85					

¹⁾ + parking brake / + freno di stationamento / + frein à main / + freno de mano

											
CITROEN CX I Kombi (75-85)											
	2000	75		09.75	05.79		13.0460-4911.2	604911	20389 15,4 Belagsatz-Zubehör	CIT	
	2000	78		06.79	08.85		13.0460-0264.2	610264			
	2200	85		06.81	08.85						
	2200 D	49		08.76	02.79						
	2400	85		08.78	05.80						
	2400	88		06.80	05.82						
	2400 GTi	94		07.82	06.83						
	2500 D	55		02.78	08.85						
	2500 D Turbo	70		04.83	08.85						
	2500 TRi	100		07.83	08.85						
CITROEN CX II Limousine (86-92)											
	20	78		09.85	12.92		13.0460-4900.2	604900	+ Handbremse ¹⁾	20371 8,1 Belagsatz-Zubehör	CIT
	22 TRS	83		09.85	12.92		13.0460-0408.2	610408			
	22 TRS	85		09.85	07.89						
	25 D	54		09.85	12.92						
	25 D Turbo	70		09.85	12.86						
	25 D Turbo 2	88		01.87	12.92						
	25 GTi	89		05.86	12.92						
	25 GTi Turbo 2	115		09.86	12.92						
	25 GTi Turbo 2	122		09.85	12.92						
	25 TRi	100		09.85	12.92						
	20	78		09.85	12.92		24.0120-0108.1	420108		260 20,0 18,0 V	
	22 TRS	83		09.85	12.92						
	22 TRS	85		09.85	07.89						
	25 D	54		09.85	12.92						
	25 D Turbo	70		09.85	12.86						
	25 D Turbo 2	88		01.87	12.92						
	25 GTi	89		05.86	12.92						
	25 GTi Turbo 2	115		09.86	12.92						
	25 GTi Turbo 2	122		09.85	12.92						
	25 TRi	100		09.85	12.92						
CITROEN CX II Kombi (86-92)											
	20	78		09.85	08.86		13.0460-4900.2	604900	+ Handbremse ¹⁾	20371 8,1 Belagsatz-Zubehör	CIT
	22 TRS	83		09.85	12.92		13.0460-0408.2	610408			
	22 TRS	85		09.85	07.89						
	25 D	54		05.86	12.92						
	25 D Turbo	70		09.85	12.86						
	25 D Turbo 2	88		01.87	12.92						
	25 i	89		05.86	12.92						
	25 TRi	100		09.85	12.92						
	20	78		09.85	08.86		24.0120-0108.1	420108		260 20,0 18,0 V	
	22 TRS	83		09.85	12.92						
	22 TRS	85		09.85	07.89						
	25 D	54		05.86	12.92						
	25 D Turbo	70		09.85	12.86						
	25 D Turbo 2	88		01.87	12.92						
	25 i	89		05.86	12.92						
	25 TRi	100		09.85	12.92						
	20	78		09.85	08.86		13.0460-4911.2	604911		20389 15,4 Belagsatz-Zubehör	CIT
	22 TRS	83		09.85	12.92		13.0460-0264.2	610264			
	22 TRS	85		09.85	07.89						
	25 D	54		05.86	12.92						
	25 D Turbo	70		09.85	12.86						
	25 D Turbo 2	88		01.87	12.92						
	25 i	89		05.86	12.92						
	25 TRi	100		09.85	12.92						
CITROEN C15 (84-05)											
	1.0		ORGA 04195	10.84			24.2117-1501.3	010398		THz 17,46	
	1.0		ORGA 04195	10.84			24.2119-1705.3	010460		THz 19,05	
	1.1	▶ 40	ORGA 04195	07.87							
	1.4		ORGA 04195	07.86							
	1.4	▶ 55	ORGA 04195	05.87							
	1.0		ORGA 04196	12.97			24.3481-1609.7	220197		D=48, + Halter	LUC
	1.1 (1118)	44	ORGA 04196	09.87	12.96 + (F)		24.3481-1610.7	220198			
	1.1 (1124)		ORGA 04196	12.96							
	1.3			09.87	05.88 + (F)						
	1.4		ORGA 04196	12.96							
	1.4	55		05.87	07.96						
	1.8 D			10.84	12.00						
	1.8 D	44		04.87	08.00						
	1.0		ORGA 04196	12.97			13.0460-2825.2	602825		21614 17,7 +/-WK Belagsatz-Zubehör	LUC
	1.1 (1118)	44	ORGA 04196	09.87	12.96 + (F)		13.0460-0060.2	610060			
	1.1 (1124)		ORGA 04196	12.96							
	1.3			09.87	05.88 + (F)						
	1.4			07.96	12.96						
	1.4	55		05.87	07.96						
	1.8 D			10.84	12.00						
	1.8 D	44		04.87	08.00						
	1.9 D			12.00	12.05		13.0460-3952.2	603952		20905 18,0 +/-WK Belagsatz-Zubehör	BDX
							13.0460-0403.2	610403			
	1.0		ORGA 04195	10.84			24.0109-0108.1	409108		245 9,0 7,0	
	1.1 (1124)		ORGA 04195	10.84							
	1.4		ORGA 04195	07.86							

¹⁾ + parking brake / + freno di stationamento / + frein à main / + freno de mano

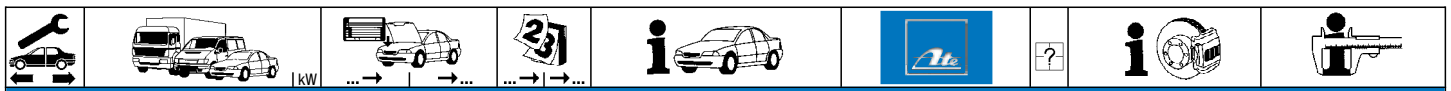

CITROEN C15 (84-05)

	1.4	55	ORGA 04195	05.87	12.97	24.0109-0108.1	409108		245 9,0 7,0
	1.0		ORGA 04196		12.97	24.0110-0187.1	410187		247 10,0 9,0 +S +B
	1.1 (1118)	44		09.87	12.96 + (F)				
	1.1 (1124)		ORGA 04196		12.96				
	1.3		ORGA 04196	09.87	05.88 + (F)				
	1.4		ORGA 04196		12.96				
	1.4	55	ORGA 04196		07.96				
	1.8 D			10.84	12.00				
	1.8 D	44		04.87	08.00				
	1.9 D			12.00	12.05				
	1.0		ORGA 04196		12.97	24.5112-0325.3	330415	2	L=355
	1.1 (1118)	44		09.87	12.96 + (F)				
	1.1 (1124)		ORGA 04196		12.96				
	1.3		ORGA 04196	09.87	05.88 + (F)				
	1.4		ORGA 04196		12.96				
	1.4	55	ORGA 04196		07.96				
	1.8 D			10.84	12.00				
	1.8 D	44		04.87	08.00				
	1.9 D			12.00	12.05				
	1.0			10.84	12.97	24.5228-0185.3	330107	2	L=185
	1.1 (1118)	44		09.87	12.96 + (F)				
	1.1 (1124)			10.84	12.96				
	1.3			09.87	05.88 + (F)				
	1.4			07.86	12.96				
	1.4	55		05.87	07.96				
	1.8 D			10.84	12.00				
	1.8 D	44		04.87	08.00				
	1.9 D			12.00	12.05				
	1.0			10.84	12.97	24.3222-1118.3	020315		Rz 22,20 BDX
	1.1	40		10.84	12.96				
	1.3			09.87	05.88 + (F)				
	1.4			07.86	12.96				
	1.4	55		05.87	07.96				
	1.8 D			10.84	12.00				
	1.8 D	44		04.87	08.00				
	1.9 D			12.00	12.05				
	1.0			10.84	12.97	03.0137-0285.2	650285		229 x 42 AUT BDX
	1.1	40		10.84	12.96	03.0137-9188.2	669188		Bremsbacken-Zubehör BDX
	1.3			09.87	05.88 + (F)				
	1.4			07.86	12.96				
	1.4	55		05.87	07.96				
	1.8 D			10.84	12.00				
	1.8 D	44		04.87	08.00				
	1.9 D			12.00	03.01				
	1.0		ORGA 04196		12.97	24.0222-8017.1	480071		229/230 x 50,8
	1.1 (1118)	44		09.87	12.96 + (F)				
	1.1 (1124)		ORGA 04196		12.96				
	1.3		ORGA 04196	09.87	05.88 + (F)				
	1.4		ORGA 04196		12.96				
	1.4	55	ORGA 04196		07.96				
	1.8 D			10.84	12.00				
	1.8 D	44		04.87	08.00				
	1.9 D			12.00	12.05				
	1.0			10.84	12.97	03.0520-2022.3	692022		22,20/229x42 TopKit BDX
	1.1	40		10.84	12.96				
	1.3			09.87	05.88 + (F)				
	1.4			07.86	12.96				
	1.4	55		05.87	07.96				
	1.8 D			10.84	12.00				
	1.8 D	44		04.87	08.00				
	1.9 D			12.00	12.05				
	1.0			10.84	12.97	24.3727-0324.2	580324	2 ↓	Länge beachten ¹⁾
	1.1	40		10.84	12.96				
	1.3			09.87	05.88 + (F)				
	1.4			07.86	12.96				
	1.4	55		05.87	07.96				
	1.8 D			10.84	12.00				
	1.8 D	44		04.87	08.00				
	1.9 D			12.00	12.05				
	1.0			10.84	12.97	24.6512-1507.3	320023		BRL (3)
	1.1 (1118)	44		09.87	12.96 + (F)				
	1.1 (1124)			10.84	12.96				
	1.3			09.87	05.88 + (F)				
	1.4			07.86	12.96				
	1.4	55		05.87	07.96				
	1.8 D			10.84	12.00				
	1.8 D	44		04.87	08.00				
	1.9 D			12.00	12.05				

















CITROEN C25 (81-94)

	1.8			07.87	03.94	24.2122-0801.3	010373	1 Anschluß verschließen ²⁾	THz 22,20
	1.9 D			07.87	03.94				
	1.9 DT	60		10.91	01.94				
	1.9 TD			04.92	03.94				
	2.0			11.81	03.94				
	2.5 D			10.85	03.94				- 1,8 t
	2.5 D 4X4	55		11.83	12.86				- 1,8 t
↓									



















¹⁾ notice length / attenzione lunghezza / faire attention longueur / atención largo

²⁾ 1 close (plug) connection / tappare 1 raccordo / fermer 1 raccord / cerrar 1 conexión































									
CITROEN C25 (81-94)									
	2.5 TD			08.87	03.94	24.2122-0801.3	010373	1 Anschluß verschließen ¹⁾	THz 22,20
	1.8 1.9 D 1.9 DT 1.9 TD 2.0 2.5 D 2.5 D 4X4 2.5 TD	155248 155248 60 155248 155248 155248 55 155248 155248		03.94 03.94 01.94 04.92 03.94 03.94 03.94 -1,8 t 12.86 -1,8 t 03.94 -1,8 t		24.0101-3801.2	260045		Bremssattel-Zubehör LUC
	1.8 1.9 D 1.9 DT 1.9 TD 2.0 2.5 D 2.5 D 4X4 2.5 TD	60 55		07.87 03.94 07.87 03.94 10.91 01.94 04.92 03.94 11.81 03.94 10.85 03.94 -1,8 t 11.83 12.86 -1,8 t 08.87 03.94 -1,8 t		13.0460-2901.2	602901		20741 19,0 +WK/S LUC
	2.5 D 2.5 D 4X4 2.5 TD	55		10.85 03.94 +1,8 t 11.83 12.86 +1,8 t 08.87 03.94 +1,8 t		13.0460-2902.2	602902		21205 19,0 +WK/S LUC
	1.8 1.9 D 1.9 DT 2.0 2.5 D 2.5 D 4X4 2.5 TD	60 55	155247 155247 155247 155247 155247 155247 155247	07.87 07.87 10.91 11.81 10.85 11.83 08.87	-1,8 t -1,8 t -1,8 t	24.0113-0168.1	413168		256 13,0 11,0
	1.8 1.9 D 1.9 DT 1.9 TD 2.0 2.5 D 2.5 D 4X4 2.5 TD	155248 155248 60 155248 155248 155248 55 155248 155248		03.94 03.94 01.94 04.92 03.94 03.94 03.94 -1,8 t 12.86 -1,8 t 03.94 -1,8 t		24.0116-0105.1	416105		256 16,1 13,5 +B
	2.5 D 2.5 D 4X4 2.5 TD	55		10.85 03.94 +1,8 t 11.83 12.86 +1,8 t 08.87 03.94 +1,8 t		24.0116-0106.1	416106		290 16,0 14,8
	1.8 1.9 D 1.9 DT 2.0 2.5 D 2.5 D 4X4	60 55	171999 171999 171999 171999 171999 171999	07.87 07.87 10.91 11.81 10.85 11.83		24.5112-0362.3	330512	4	L=362
	1.8 1.9 D 1.9 DT 1.9 TD 2.0 2.5 D 2.5 D 4X4 2.5 TD	172000 172000 60 172000 172000 172000 55 172000 172000		03.94 03.94 01.94 04.92 03.94 03.94 03.94 12.86 08.87 03.94		24.5112-0435.3 24.5112-0436.3	330524 330574	2 2	L=435, + Clip L=435, - Clip
	1.8 2.0 2.5 TD			07.87 03.94 11.81 03.94 08.87 03.94 -1,8 t		24.5112-0260.3	330577	1 <input type="checkbox"/>	L=260
	1.9 D 1.9 DT 2.5 D 2.5 D 4X4 2.5 TD	60 55		07.87 03.94 10.91 01.94 10.85 03.94 11.83 12.86 08.87 03.94 +1,8 t		24.5112-0285.3	330604	1 <input type="checkbox"/>	L=285
	1.8 1.9 D 1.9 DT 1.9 TD 2.0 2.5 D 2.5 D 4X4 2.5 TD	073501 073501 60 073501 073501 073501 55 073501 073501		03.94 -0,8 t 03.94 01.94 04.92 03.94 03.94 03.94 -1,8 t 12.86 -1,8 t 03.94 -1,8 t		24.3225-1101.3	020294		Rz 25,40 LUC
	2.5 D 2.5 D 4X4 2.5 TD	55		10.85 03.94 +1,8 t 11.83 12.86 +1,8 t 08.87 03.94 +1,8 t		24.3226-1101.3	020296		Rz 26,99
	1.8 1.9 D 1.9 DT 1.9 TD 2.0 2.5 D 2.5 D 4X4 2.5 TD	60 55		07.87 03.94 07.87 03.94 10.91 01.94 04.92 03.94 11.81 03.94 10.85 03.94 -1,8 t 11.83 12.86 -1,8 t 08.87 03.94 -1,8 t		03.0137-0330.2 03.0137-9216.2	650330 669216		254 x 57 HEB LUC Bremsbacken-Zubehör LUC
	2.5 D 2.5 D 4X4 2.5 TD	55		10.85 03.94 +1,8 t 11.83 12.86 +1,8 t 08.87 03.94 +1,8 t		03.0137-0269.2 03.0137-9169.2	650269 669169		254 x 57 HEB Bremsbacken-Zubehör

¹⁾ 1 close (plug) connection / tappare 1 raccordo / fermer 1 raccord / cerrar 1 conexión

CITROEN C25 (81-94)										
	1.8 1.9 D 1.9 DT 1.9 TD 2.0 2.5 D 2.5 D 4X4 2.5 TD	60 55		07.87 07.87 10.91 04.92 11.81 10.85 11.83 08.87	03.94 03.94 01.94 03.94 03.94 03.94 12.86 03.94	24.0225-4002.1	480048			254/255,6 x 63,5
	1.8 1.9 D 1.9 DT 1.9 TD 2.0 2.5 D 2.5 D 4X4 2.5 TD	073501 073501 60 073501 073501 073501 55 073501 073501		03.94 03.94 01.94 04.92 03.94 03.94 12.86 03.94	-0,8 t -1,8 t -1,8 t -1,8 t	03.0520-0125.3	690125			25,40/254x57 TopKit LUC
	1.8 1.9 D 1.9 DT 1.9 TD 2.0 2.5 D 2.5 D 4X4 2.5 TD	60 55		07.87 07.87 10.91 04.92 11.81 10.85 11.83 08.87	03.94 03.94 01.94 03.94 03.94 03.94 12.86 03.94	24.3727-0527.2	580527	1		L=2566
	1.8 1.9 D 1.9 DT 2.0 2.5 D 2.5 D 4X4 2.5 TD	60 55	073500 073500 073500 073500 073500 073500	07.87 07.87 10.91 11.81 10.85 11.83 08.87		24.6513-1701.3	320160			BRL 3/10 (4)
	1.8 1.9 D 2.0 2.5 D 2.5 D 4X4 2.5 TD	55		07.87 07.87 11.81 10.85 11.83 08.87	06.90 06.90 06.90 06.90 12.86 06.90	24.3728-0515.2	590515			L=1200
CITROEN DYANE (69-83)										
	0.6			08.77	07.83	13.0460-4906.2	604906			20207 12,0 CIT
	0.6			08.77	07.83	24.0107-0100.1	407100			244 7,0 6,3
	0.4 0.6			09.69 09.69	06.70 06.70	24.3228-1102.3	020347			Rz 28,57
	0.4 0.6			07.70 07.70	07.75 07.77	24.3228-1101.3	020297			Rz 28,57
	0.4 0.6			07.70 07.70	07.75 07.77	03.0420-0228.3	680228			28,57/200x36 Kit CIT
	0.4 0.6			07.70 07.70	07.75 07.77	24.3217-1101.3	020309			Rz 17,46
	0.6			08.78	07.83	24.3215-1602.3	020355			Rz 15,87
	0.4 0.6			01.70 01.70	07.75 07.83	03.0137-0092.2 03.0137-9070.2	650092 669070			180 x 34 Bremsbacken-Zubehör BDX
CITROEN LN/LNA (76-86)										
	0.6			11.78	12.86	24.2117-1501.3	010398			THz 17,46
	0.6 1.1			10.81 07.82	12.86 12.86	24.0109-0108.1	409108			245 9,0 7,0
	0.6 1.1			07.82 07.82	12.86 12.86	83.6196-0325.3	330727			L=325
	0.6			11.77	06.82	24.3222-1102.3	020257			Rz 22,20 BDX
	0.6 0.6 1.1			11.78 07.82 07.82	06.82 12.86 12.86	24.3220-1105.3	020216			Rz 20,64 BDX
	0.6 1.1			11.76 07.82	10.77 12.86	03.0137-9032.2	669032			Bremsbacken-Zubehör BDX
	1.1			07.82	12.86	03.6043-0201.3	320026			BR S/3 (3) ATE

1) - Citroen brake / - freno Citroen / - freins Citroen / - freno de Citroen

2) + Citroen brake / + freno Citroen / + freins Citroen / + freno de Citroen

								
CITROEN MEHARI (68-87)								
	0.6			01.77	12.87	24.0107-0100.1	407100	244 7,0 6,3
	0.6			01.72	07.77	24.3228-1101.3	020297	Rz 28,57
	0.6			01.68	07.77	24.3217-1101.3	020309	Rz 17,46
	0.6			01.68	12.87	03.0137-0092.2 03.0137-9070.2	650092 669070	180 x 34 Bremsbacken-Zubehör BDX
CITROEN VISA (78-89)								
	0.6			09.78	12.89	24.2117-1501.3	010398	THz 17,46
	1.0 1.1 E 1.1 RE 1.1 Super/E/L 1.2 Super X 1.4		ORGA 02857	11.83 05.81 04.83 05.81 09.80 03.82	12.89 + Bremsgerät ¹⁾ + Bremsgerät ¹⁾ + Bremsgerät ¹⁾ 06.82	24.2119-1705.3	010460	THz 19,05
	1.7 D			04.84	12.89	24.3481-1609.7 24.3481-1610.7	220197 220198	D=48, + Halter LUC D=48, + Halter LUC
	1.7 D			04.84	12.89	13.0460-2825.2 13.0460-0060.2	602825 610060	21614 17,7 +/WK LUC Belagsatz-Zubehör LUC
	1.0 1.1 1.1 RE 1.2 Super X 1.4 TRS			11.83 05.81 04.83 09.80 07.84	12.89 12.89 10.88 06.82 12.87	24.0109-0108.1	409108	245 9,0 7,0
	1.6 GTI 1.7 D			01.85 04.84	12.89 12.89	24.0120-0131.1 24.0110-0187.1	420131 410187	247 20,4 18,5 V 247 10,0 9,0 +S +B
	0.6 1.0 1.1 1.1 RE 1.2 Super X 1.4			09.78 11.83 09.78 04.83 09.80 03.82	12.89 + BVB4-Getriebe ²⁾ + BVB4-Getriebe ²⁾ + BVB4-Getriebe ²⁾ + BVB4-Getriebe ²⁾ + BVB4-Getriebe ²⁾	83.6196-0325.3	330727	2 L=325
	0.6 1.0 1.1 1.1 RE 1.2 Super X 1.4			05.81 11.83 05.81 04.83 05.81 03.82	12.89 + BVB5-Getriebe ³⁾ + BVB5-Getriebe ³⁾ + BVB5-Getriebe ³⁾ + BVB5-Getriebe ³⁾ + BVB5-Getriebe ³⁾	83.6196-0325.3	330727	L=325
	0.6 1.1			09.78 09.78	12.89 12.89	24.3222-1102.3	020257	Rz 22,20 BDX
	0.6 1.1			09.78 09.78	12.89 04.81	24.3220-1105.3	020216	Rz 20,64 BDX
	0.6 1.0 1.1 1.2 Super X 1.4			09.78 11.83 09.78 09.80 03.82	12.89 12.89 12.89 06.82 12.89	03.0137-9032.2	669032	Bremsbacken-Zubehör BDX
	1.6 GTI 1.7 D			01.85 04.84	12.89 12.89	03.0137-9055.2	669055	Bremsbacken-Zubehör BDX
	0.6 1.0 1.1 1.2 Super X 1.4 1.6 GTI 1.7 D			05.81 11.83 05.81 09.80 03.82 01.85 04.84	12.89 12.89 12.89 06.82 12.89 12.89	24.6512-1507.3	320023	BRL (3)
CITROEN XM (Y3) Limousine (89-94)								
	2.0 2.0 2.0 i 2.0 i 2.0 i 2.1 D 2.1 TD 3.0 24V 3.0 V6	84 94 79 89 99 60 80 147 123	ORGA 05228 ORGA 05228 ORGA 05228 ORGA 05228 ORGA 05228 ORGA 05228 ORGA 05228 ORGA 05228	05.89 05.89 05.89 05.89 05.89 05.89 05.89 07.90 05.89		13.0460-3916.2 13.0460-0206.2	603916 610206	21296 16,5 +/WK BDX Belagsatz-Zubehör BDX
	2.0 2.0 2.0 i 2.0 i 2.0 i 2.0 Turbo 2.1 D 2.1 TD 3.0 24V	84 94 79 89 99 104 60 80 147	ORGA 05229 ORGA 05229 ORGA 05229 ORGA 05229 ORGA 05229 ORGA 05229 ORGA 05229 ORGA 05229	04.94 06.94 04.94 06.94 06.94 09.92 06.94 06.94 06.94		13.0460-3947.2	603947	21505 17,0 +/WK BDX

1) + booster unit / + servofreno / + servo-frein / + servofreno
2) + BVB4 transmission / + scatola cambio BVB4 / + boîte de vitesse BVB4 / + cambio BVB4
3) + BVB5 transmission / + scatola cambio BVB5 / + boîte de vitesse BVB5 / + cambio BVB5
4) - Citroen brake / - freno Citroen / - freins Citroen / - freno de Citroen
5) + Citroen brake / + freno Citroen / + freins Citroen / + freno de Citroen

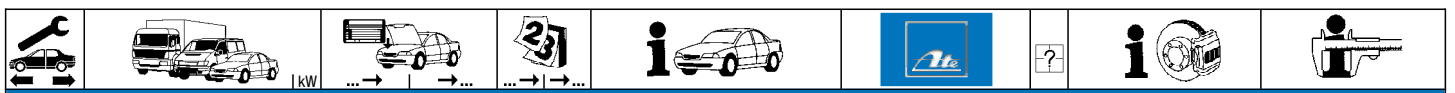



























CITROEN XM (Y3) Limousine (89-94)



























	3.0 V6	123	ORGA 05229		06.94		13.0460-3947.2	603947			21505 17,0 +/-WK	BDX
	2.0	84	ORGA 05228		05.89		24.0122-0141.1	422141			276 22,0 20,0 V	
	2.0	94	ORGA 05228		05.89							
	2.0 i	79	ORGA 05228		05.89							
	2.0 i	89	ORGA 05228		05.89							
	2.0 i	99	ORGA 05228		05.89							
	2.1 D	60	ORGA 05228		05.89							
	2.1 TD	80	ORGA 05228		05.89							
	3.0 24V	147	ORGA 05228		07.90							
	3.0 V6	123	ORGA 05228		05.89							
	2.0	84	ORGA 05229		04.94		24.0126-0100.1	426100			283 26,0 24,0 V L	
	2.0	94	ORGA 05229		06.94							
	2.0 i	79	ORGA 05229		04.94							
	2.0 i	89	ORGA 05229		06.94							
	2.0 i	99	ORGA 05229		06.94							
	2.0 Turbo	104		09.92	06.94							
	2.1 D	60	ORGA 05229		06.94							
	2.1 TD	80	ORGA 05229		06.94							
	3.0 24V	147	ORGA 05229		06.94							
3.0 V6	123	ORGA 05229		06.94								
	2.0	84			05.89		24.5411-0550.3	330567	2		L=550	
	2.0	94			05.89	04.94						
	2.0 i	79			05.89	04.94						
	2.0 i	89			05.89	06.94						
	2.0 i	99			05.89	06.94						
	2.0 Turbo	104			09.92	06.94						
	2.1 D	60			05.89	06.94						
	2.1 TD	80			05.89	06.94						
	3.0 24V	147			07.90	06.94						
3.0 V6	123			05.89	06.94							
	2.0 i	79			05.89	04.94	13.0460-4911.2	604911			20389 15,4	CIT
	2.0	84			05.89	04.94						
	2.0	94			05.89	06.94						
	2.0 i	89			05.89	06.94						
	2.0 i	99			05.89	06.94						
	2.0 Turbo	104			09.92	06.94						
	2.1 D	60			05.89	06.94						
	2.1 TD	80			05.89	06.94						
	3.0 24V	147			07.90	06.94						
3.0 V6	123			05.89	06.94							
	2.0 i	79			05.89	04.94	13.0460-4956.2	604956			20162 15,4	CIT
	2.0	84			05.89	06.94						
	2.0	94			05.89	06.94						
	2.0 i	89			05.89	06.94						
	2.0 i	99			05.89	06.94						
	2.0 Turbo	104			09.92	06.94						
	2.1 D	60			05.89	06.94						
	2.1 TD	80			05.89	06.94						
	3.0 24V	147			07.90	06.94						
3.0 V6	123			05.89	06.94							
	2.0 i	79			05.89	04.94	24.0112-0136.2	412136			251 12,0 10,8	
	2.0	84			05.89	04.94						
	2.0	94			05.89	06.94						
	2.0 i	89			05.89	06.94						
	2.0 i	99			05.89	06.94						
	2.0 Turbo	104			09.92	06.94						
	2.1 D	60			05.89	06.94						
	2.1 TD	80			05.89	06.94						
	3.0 24V	147			07.90	06.94						
3.0 V6	123			05.89	06.94							
	2.0	84			05.89	04.94	24.3727-0309.2	580309	<input type="checkbox"/>		L=1030	
	2.0	94			05.89	06.94						
	2.0 i	79			05.89	04.94						
	2.0 i	89			05.89	06.94						
	2.0 i	99			05.89	06.94						
	2.0 Turbo	104			09.92	06.94						
	2.1 D	60			05.89	06.94						
	2.1 TD	80			05.89	06.94						
	3.0 V6	123			05.89	06.94						
3.0 24V	147			07.90	06.94							
						24.3727-0308.2	580308	<input type="checkbox"/>		L=1230		

CITROEN XM (Y3) Kombi (91-94)

	2.0	85	ORGA 05228		10.91		13.0460-3916.2	603916			21296 16,5 +/-WK	BDX						
	2.0	94	ORGA 05228		05.89		13.0460-0206.2	610206			Belagsatz-Zubehör	BDX						
	2.0 i	79	ORGA 05228		11.91													
	2.0 i	89	ORGA 05228		11.91													
	2.1 D	60	ORGA 05228		11.91													
	2.1 TD	80	ORGA 05228		11.91													
	3.0 V6	123	ORGA 05228		11.91													
	2.0	85	ORGA 05229			07.94							13.0460-3947.2	603947			21505 17,0 +/-WK	BDX
	2.0	94	ORGA 05229			06.94												
	2.0 i	79	ORGA 05229			04.94												
2.0 i	89	ORGA 05229			04.94													
2.0 Turbo	104		09.92	04.94														
2.1 D	60	ORGA 05229		04.94														
2.1 TD	80	ORGA 05229		04.94														
3.0 V6	123	ORGA 05229		04.94														
	2.0	85	ORGA 05228		10.91		24.0122-0141.1	422141			276 22,0 20,0 V							
	2.0	94	ORGA 05228		05.89													
	2.0 i	79	ORGA 05228		11.91													
	2.0 i	89	ORGA 05228		11.91													
	2.1 D	60	ORGA 05228		11.91													





































								
CITROEN XM (Y3) Kombi (91-94)								
	2.1 TD 3.0 V6	80 123	ORGA 05228 ORGA 05228	11.91 11.91		24.0122-0141.1	422141	276 22,0 20,0 V
	2.0 2.0 2.0 i 2.0 i 2.0 Turbo 2.1 D 2.1 TD 3.0 V6	85 ORGA 05229 94 ORGA 05229 79 ORGA 05229 89 ORGA 05229 104 60 ORGA 05229 80 ORGA 05229 123 ORGA 05229		07.94 06.94 04.94 04.94 04.94 04.94 04.94 04.94		24.0126-0100.1	426100	283 26,0 24,0 V L
	2.0 2.0 2.0 i 2.0 i 2.0 Turbo 2.1 D 2.1 TD 3.0 V6	85 94 79 89 104 60 80 123		10.91 05.89 11.91 11.91 09.92 11.91 11.91 11.91	07.94 06.94 04.94 04.94 04.94 04.94 04.94 04.94	24.5411-0550.3	330567	2 L=550
	2.0 2.0 2.0 i 2.0 i 2.0 Turbo 2.1 D 2.1 TD 3.0 V6	85 94 79 89 104 60 80 123		10.91 05.89 11.91 11.91 09.92 11.91 11.91 11.91	07.94 06.94 04.94 04.94 04.94 04.94 04.94 04.94	13.0460-4911.2 13.0460-0264.2	604911 610264	20389 15,4 Belagsatz-Zubehör CIT
	2.0 2.0 2.0 i 2.0 i 2.0 Turbo 2.1 D 2.1 TD 3.0 V6	85 94 79 89 104 60 80 123		10.91 05.89 11.91 11.91 09.92 11.91 11.91 11.91	07.94 06.94 04.94 04.94 04.94 04.94 04.94 04.94	24.0112-0136.2	412136	251 12,0 10,8
	2.0 2.0 2.0 i 2.0 i 2.0 Turbo 2.1 D 2.1 TD 3.0 V6	85 94 79 89 104 60 80 123		10.91 05.89 11.91 11.91 09.92 11.91 11.91 11.91	07.94 06.94 04.94 04.94 04.94 04.94 04.94 04.94	24.3727-0309.2 24.3727-0308.2	580309 580308	<input type="checkbox"/> <input type="checkbox"/> L=1030 L=1230
	3.0 V6	123		11.91	04.94	24.3727-0308.2	580308	<input type="checkbox"/> L=1230
DAF 428-435 (89-93)								
	428 431 435			01.89 01.89 01.89	08.93 08.93 08.93	03.0137-0309.2	650309	254 x 70
DAF 44 (66-74)								
	0.8			09.72	09.74	03.3508-8302.3	310046	Behälter ATE
	0.8			11.66	09.74	83.6104-0220.3	330474	L=220
	0.8			11.66	09.74	03.3217-0401.3	020023	Rz 17,46
DAF 55 (67-72)								
	1.1			10.67	09.72	03.3508-8302.3	310046	Behälter ATE
	1.1			10.67	09.72	13.0460-3010.2	603010	20009 15,0 ATE
	1.1			10.67	09.72	83.6104-0220.3	330474	2 L=220
	1.1			10.67	09.72	83.6104-0220.3	330474	2 L=220
	1.1			10.67	09.72	03.3217-0401.3	020023	Rz 17,46
DAF 66 (72-75)								
	1.1 1.3			09.72 09.73	06.75 06.75	13.0460-3010.2	603010	20009 15,0 ATE
	1.1 1.3			09.72 09.73	06.75 06.75	83.6104-0220.3	330474	2 L=220

								
DAF 66 (72-75)								
	1.1 1.3		09.72 09.73	06.75 06.75	03.0137-9173.2	669173		Bremsbacken-Zubehör
DAIHATSU CHARADE (78-87)								
	1.0 (G10/20)		01.78	02.83 - (GM) (USA)	03.0137-9085.2	669085		Bremsbacken-Zubehör
DAIHATSU CHARADE (87-92)								
	1.0 (G100)	38	02.87	12.92	24.0111-0139.1	411139		234 11,0 10,0
	1.0 (G100)	40	11.90	12.92				
	1.0 (G100)	41	04.89	12.92				
	1.0 D (G101)	27	02.87	12.92				
	1.0 TD (G101)	35	02.87	12.92				
	1.0 Turbo (G100)	50	02.87	10.90				
	1.3 (G102)	66	06.88	12.92				
	1.0 GTi (G100)	74	02.87	12.92	24.0118-0126.1	418126		235 18,0 17,0 V
	1.3 (G102)	66	06.88	12.92 + 4 türig ¹⁾				
	1.0 (G100)	38	02.87	12.92	03.0137-0186.2	650186		180 x 28 Bremsbacken-Zubehör
	1.0 (G100)	40	11.90	12.92	03.0137-9126.2	669126		
	1.0 (G100)	41	04.89	12.92				
	1.0 D (G101)	27	02.87	12.92				
	1.0 TD (G101)	35	02.87	12.92				
	1.0 Turbo (G100)	50	02.87	10.90				
	1.3 (G102)	66	06.88	12.92	03.0137-0315.2	650315		200 x 32 Bremsbacken-Zubehör
					03.0137-9271.2	669271		
DAIHATSU CUORE (80-85)								
	0.55 (L55)	20	08.80	08.85 - (GM) (USA)	03.0137-9085.2	669085		Bremsbacken-Zubehör
DAIHATSU CUORE (85-90)								
	0.85 (L80)		09.85	12.90	24.0110-0235.1	410235		211 10,0 9,0
	0.85 4WD (L81)	32	09.86	10.88				
	0.85 (L80)		09.85	12.90	03.0137-9085.2	669085		Bremsbacken-Zubehör
DAIHATSU CUORE (90-94)								
	0.7 4WD (L201)	47	08.90	12.94	24.0116-0127.1	416127		211 16,0 14,0 V
	0.8 (L201)	30	10.90	12.94				
	0.7 4WD (L201)	47	08.90	12.94	03.0137-9085.2	669085		Bremsbacken-Zubehör
	0.8 (L201)	30	10.90	12.94				
DAIHATSU FERROZA (88-95)								
	1.6 16V (F300)		10.88	12.95 + belüftete Scheiben ²⁾	13.0460-5816.2	605816		21243 14,0
	1.6 16V (F300)		10.88	12.95	24.0118-0121.1	418121		277 18,0 17,0 V
	1.6 16V (F300)		10.88	12.95	03.0137-0316.2	650316		254 x 45
DAIMLER XJ (40,81) (89-94)								
	Double Six 6.0 Sovereign 4.0		02.93 09.89	09.94 09.94	13.0460-7138.2 24.8190-1302.2	607138 621302	2	23126 17,5 +/-WE ATE Warnkontakt L=276mm
	Double Six 6.0 Sovereign 4.0		02.93 09.89	09.94 09.94	24.0123-0108.1 24.0128-0138.1	423108 428138		295 22,5 21,0 V 291 28,1 26,0 V +B
DE TOMASO PANTERA								
	Pantera		01.71	12.93	13.0460-4964.2	604964		21381 15,0 BRE
DKW F102 (64-66)								
	1.2	44	03.64	08.66	24.3215-1105.3	020159		Rz 15,87
DKW Meisterklasse/Sonderklasse/Universal (50-57)								
	0.7 Meisterklasse 0.7 Universal		01.50 01.50	12.52 12.52	03.3125-0401.3	010290		alte Kolbenstange verwenden ³⁾ Hz 25,40 ATE

¹⁾ + 4 door / + 4 porte / + 4 portes / + 4 puertas

²⁾ + ventilated discs / + dischi ventilati / + disques ventilés / + disco ventilado

³⁾ reuse old piston rod / riutilizz. vecchio puntalino / utiliser l'ancien.tige d.pist. / utilice el vástagó viejo

								
DKW 3=6 (55-57)								
	0.9 Post 3=6		01.55	12.56	03.3125-0401.3	010290	alte Kolbenstange verwenden ¹⁾	Hz 25,40 ATE
FAUN Kraftkarren (Kraka)								
	Kraka				03.3122-0101.3	010277	(03.3122-1315.3)	Hz 22,20 ATE
FERRARI FERRARI								
	308 GTB/GTS		04.81	08.85	11.0441-5702.2	250033		Dichtungssatz ATE
	328 GTB/GTS		09.85	08.89	11.0101-5407.2	260011		Hülensatz ATE
	Mondial		04.81		11.8171-0008.1	990049		Führungsbolzen ATE
	Testarossa		01.84	12.91	11.8116-0091.1	390502	2	Haltefeder ATE
	Dino 308 GT 2+2		09.73	12.80	13.0441-4009.2	250077		Dichtungssatz ATE
	Mondial		01.80	03.81	83.6215-0400.3	330323	2	L=400
	400i		01.85		24.5224-0330.3	331263	2	L=330
	412i		01.85		24.5224-0330.3	331263	4	L=330
	Testarossa		01.84					L=330
	308 GTB/GTS		04.81	08.85	11.0441-4805.2	250020		Dichtungssatz ATE
	328 GTB/GTS		09.85	08.89	11.0101-5407.2	260011		Hülensatz ATE
	Mondial		04.81		11.8171-0008.1	990049		Führungsbolzen ATE
	Testarossa		01.84	12.91	13.0441-3406.2	250048		Dichtungssatz ATE
	Mondial		01.80		83.6101-0325.3	330206	2	L=325
	308 GTB/GTS		04.81	08.85	83.6101-0240.3	330202	2	L=240
FIAT 124 (66-74)								
	alle Typen		01.66	08.74	13.0460-3936.2	603936		20073 17,3 BDX
	alle Typen		01.66	08.74	24.0111-0130.1	411130		227 10,8 9,0 +B
	alle Typen		01.66	08.74	24.0111-0130.1	411130		227 10,8 9,0 +B
	alle Typen		01.66	08.74	24.5105-0139.3	331216	2	L=139
FIAT 125 (66-74)								
	1.6		07.67	03.74	24.2119-0806.3	010345		THz 19,05
	1.6 Special		05.69	10.73				
	1.6		07.67	03.74	13.0460-3936.2	603936		20073 17,3 BDX
	1.6 Special		05.69	10.73				
	1.6		07.67	03.74	24.0111-0130.1	411130		227 10,8 9,0 +B
	1.6 Special		05.69	10.73				
	1.6		07.67	03.74	24.0111-0130.1	411130		227 10,8 9,0 +B
	1.6 Special		05.69	10.73				
	1.6		07.67	03.74	24.5105-0139.3	331216	2	L=139
	1.6 Special		05.69	10.73				
FIAT 126 (72-90)								
	600	6129390		06.77	24.2119-0815.3	010347		THz 19,05
	650			07.77				
	700			09.87				
	600			09.72	24.3223-0801.3	020316		Rz 23,81
	600			04.76	24.3223-0802.3	020286		Rz 23,81 FI
	650			07.77				
	700			09.87				
	600			09.72	03.76	03.0137-9178.2	669178	Bremsbacken-Zubehör AP
	600			04.76	06.77	03.0137-0015.2	650015	185 x 31 AUT FI
	650			07.77	03.0137-9021.2	669021		Bremsbacken-Zubehör FI
	700			09.87				
	600			09.72	03.76	24.0218-5001.1	480012	185/186,8 x 37
	650			04.76				
	700			07.77				
	600			09.72	06.77	24.5207-0205.3	330042	2 L=205
	650			07.77				
	700			09.87				
	600			09.72	03.76	24.3215-0802.3	020308	Rz 15,87 FI
	600			04.76	24.3219-0801.3	020181		Rz 19,05 FI
	650			07.77				
	700			09.87				

¹⁾ reuse old piston rod / riutilizz. vecchio puntalino / utiliser l'ancien. tige d.pist. / utilice el vástago viejo

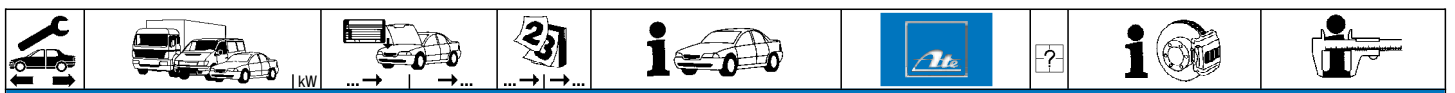

FIAT 126 (72-90)

	600			09.72	03.76		03.0137-9178.2	669178		Bremsbacken-Zubehör	AP
	600			04.76	06.77		03.0137-0015.2	650015		185 x 31 AUT	FI
	650			07.77	08.87		03.0137-9021.2	669021		Bremsbacken-Zubehör	FI
	700			09.87	07.90						
	600			04.76	06.77		24.0218-5001.1	480012		185/186,8 x 37	
	650			07.77	08.87						
	700			09.87	07.90						

FIAT 127 (71-86)









































	1.0 L/C/CL	8050133			05.83		24.2119-0806.3	010345		THz 19,05	
	1.0 Sport			07.78	02.82						
	1.3 D			04.81	12.86						
	1.3 Sport			04.81	12.86						
	Fiorino			10.77	12.86	- Bremskraftverstärker 1)					
	0.9			02.71	05.83		13.0460-3936.2	603936		20073 17,3	BDX
	1.0			04.77	05.83						
	1.0 Sport			07.78	02.82						
	1.3 D			04.81	12.86						
	1.3 Sport			04.81	12.86						
	0.9			02.71	05.83		24.0111-0130.1	411130		227 10,8 9,0 +B	
	1.0			04.77	05.83						
	1.0 Sport			07.78	02.82						
	1.3 D			04.81	12.86						
	1.3 Sport			04.81	12.86						
	0.9			02.71	05.83		24.5209-0280.3	330044	2	L=280	
	1.0			04.77	05.83						
	1.0 Sport			07.78	02.82						
	1.3 D			04.81	12.86						
	1.3 Sport			04.81	12.86						
	Fiorino	7054471		10.77	12.86						
	Fiorino	7054472			12.86		24.5209-0280.3	330044	2	L=280	
	0.9			02.71	05.83		24.5209-0250.3	330043	2	L=250	
	1.0			04.77	05.83						
	1.0 Sport			07.78	02.82						
	1.3 Sport			04.81	12.86						
	Fiorino			10.77	12.86						
	0.9			02.71	05.83		24.3219-0801.3	020181		Rz 19,05	FI
	1.0			04.77	05.83						
	1.0 Sport			07.78	02.82						
	1.3 Sport			04.81	10.82						
	Fiorino			11.82	12.86		24.3219-0803.3	020183		Rz 19,05	
	Fiorino			10.77	12.86						
	0.9			02.71	05.83		03.0137-0015.2	650015		185 x 31 AUT	FI
	1.0			04.77	05.83		03.0137-9021.2	669021		Bremsbacken-Zubehör	FI
	1.0 Sport			07.78	02.82						
	1.3 Sport			04.81	12.86						
	Fiorino			10.77	12.86						
	0.9			02.71	05.83		24.0218-5001.1	480012		185/186,8 x 37	
	1.0			04.77	05.83						
	1.0 Sport			07.78	02.82						
	1.3 Sport			04.81	12.86						
	Fiorino			10.77	12.86						
	1.3 Sport			11.82	12.86		03.0420-0319.3	680319		19,05/185x31 Kit	FI
	Fiorino			10.77	12.86						

FIAT 128 (69-84)

	1.1			01.69	12.84		13.0460-3936.2	603936		20073 17,3	BDX
	1.3			09.71	12.84						
	1.1			01.69	12.84		24.0111-0130.1	411130		227 10,8 9,0 +B	
	1.3			09.71	12.84						
	1.1			04.73	12.84		24.5209-0280.3	330044	2	L=280	
	1.3			04.73	12.84						
	1.1			04.73	12.84		24.5209-0250.3	330043	2	L=250	
	1.3			04.73	12.84						
	1.1			01.69	12.84		24.3219-0801.3	020181		Rz 19,05	FI
	1.3			09.71	12.84						
	1.1			01.69	12.84		03.0137-0015.2	650015		185 x 31 AUT	FI
	1.3			09.71	12.84		03.0137-9021.2	669021		Bremsbacken-Zubehör	FI
	1.1			09.76	12.84		24.0218-5001.1	480012		185/186,8 x 37	
	1.3			09.76	12.84						

1) - brake booster / - servofreno / - servo-frein / - refuerzo de la presión de fr.



											
FIAT 131 (74-84)											
	alle Typen			06.74	06.79		13.0460-3936.2	603936		20073 17,3	BDX
	alle Typen			09.82	06.84		13.0460-3940.2	603940		20775 18,0 /WK	BDX
	alle Typen						13.0460-0410.2	610410		Belagsatz-Zubehör	BDX
	alle Typen			06.74	12.80		24.0111-0130.1	411130		227 10,8 9,0 +B	
	alle Typen			06.74	02.81		24.5209-0280.3	330044	2	L=280	
	alle Typen			06.74	02.81		24.5105-0139.3	331216	2	L=139	
	alle Typen			06.74	06.84		03.0137-0139.2	650139		229 x 42	BDX
	alle Typen						03.0137-0124.2	650124		229 x 42 HEB AUT	BDX
	alle Typen						03.0137-9020.2	669020		Bremsbacken-Zubehör	BDX
FIAT 132 (72-81)											
	2000 alle Typen	370702		05.77 04.72	08.77	- 2000	24.2119-0806.3	010345		THz 19,05	
	alle Typen			04.72	05.81		13.0460-3936.2	603936		20073 17,3	BDX
	alle Typen			04.72	12.76		24.0111-0130.1	411130		227 10,8 9,0 +B	
	alle Typen			01.77	05.81		24.0111-0129.1	411129		251 11,0 9,5	
	alle Typen			04.72	05.81		24.5209-0353.3	330046	2	L=350	
	alle Typen			04.72	12.76		24.0111-0130.1	411130		227 10,8 9,0 +B	
	alle Typen			05.77	05.81		24.5105-0139.3	331216	2	L=139	
	alle Typen			01.77	05.81		03.0137-0139.2	650139		229 x 42	BDX
	alle Typen						03.0137-0124.2	650124		229 x 42 HEB AUT	BDX
	alle Typen						03.0137-9020.2	669020		Bremsbacken-Zubehör	BDX
FIAT 500/600 (-75)											
	500 F 600				12.73 12.70		24.3222-0801.3	020248		Rz 22,20	
	500 R			11.72	12.75		24.3223-0801.3	020316		Rz 23,81	
	500			01.57	12.75		03.0137-9178.2	669178		Bremsbacken-Zubehör	AP
	500 R			11.72	12.75		24.5207-0205.3	330042	2	L=205	
	500 F 600				12.73 12.70		24.3219-0802.3	020182		Rz 19,05	
	500 R			11.72	12.75		24.3215-0802.3	020308		Rz 15,87	FI
	500			01.57	12.75		03.0137-9178.2	669178		Bremsbacken-Zubehör	AP
FIAT 850 (68-72)											
	850 Sport Coupe 850 Sport Spider			02.68 03.68	10.72 10.72		24.0111-0130.1	411130		227 10,8 9,0 +B	
	850 Sport Coupe 850 Sport Spider			02.68 03.68	10.72 10.72		24.5209-0353.3	330046	2	L=350	
	850 Sport Coupe 850 Sport Spider			02.68 03.68	10.72 10.72		24.3219-0801.3	020181		Rz 19,05	FI
	850 Sport Coupe 850 Sport Spider			02.68 03.68	10.72 10.72		03.0137-0015.2	650015		185 x 31 AUT	FI
	850 Sport Coupe 850 Sport Spider						03.0137-9021.2	669021		Bremsbacken-Zubehör	FI
FIAT 900 (78-85)											
	0.9			01.78	12.85		24.5207-0205.3	330042	2	L=205	
	0.9			01.78	12.85		03.0137-0015.2	650015		185 x 31 AUT	FI
							03.0137-9021.2	669021		Bremsbacken-Zubehör	FI

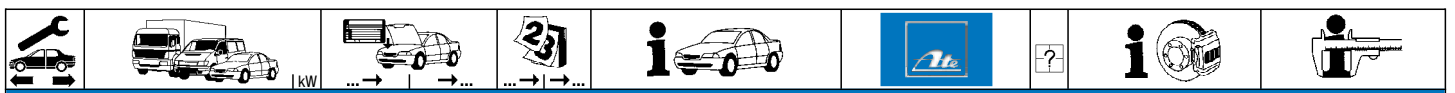









FIAT ARGENTA (81-86)										
	1.6 (100) 2.0 (110) 2.0 i.e. (120) 2.5 D 2.5 TD			06.83 06.83 06.83 06.83 06.83	08.83 07.86 07.86 11.85 07.86		13.0460-2941.2	602941		20839 17,0 /WK/S LUC
	1.6 (100) 2.0 (110) 2.0 i.e. (120) 2.5 D 2.5 TD			09.81 09.81 09.81 09.81 09.81	08.83 07.86 07.86 11.85 07.86		24.0112-0112.1	412112		257 12,0 10,8
	2.5 TD			09.81	07.86		13.0460-3942.2	603942		20841 12,0 /WE BDX
	1.6 (100) 2.0 (110) 2.0 i.e. (120) 2.5 D			09.81 09.81 09.81 09.81	08.83 07.86 07.86 11.85		03.0137-0139.2 03.0137-0124.2 03.0137-9020.2	650139 650124 669020		229 x 42 BDX 229 x 42 HEB AUT BDX Bremsbacken-Zubehör BDX

FIAT CROMA (85-90)										
	1.6 2.0 2.0 i.e. 2.5 D		0182984 0182984 0182984 0182984	12.85 12.85 12.85 12.85			24.3541-1748.5	240222		D=54, - Halter LUC
	1.6 1.9 TD 2.0 2.0 i.e. 2.0 i.e. Turbo 2.5 D 2.5 TD	0182985 0182985 0182985 0182985 0182985		12.88 10.90 10.90 10.90 10.90 10.90			13.0460-2952.2	602952		21185 19,4 +/WK/S LUC
	2.0 i.e. 2.0 i.e. Turbo			12.85 12.85	10.90 10.90	+ gepanzerte Fahrzeuge ³⁾ + gepanzerte Fahrzeuge ³⁾	13.0460-2979.2	602979		21147 19,0 +/WK/S LUC
	1.6 1.9 TD 2.0 2.0 i.e. 2.5 D	0182985 0182985 0182985 0182985		12.88 10.90 10.90 10.90 10.90		- ABS - ABS / - gepanzerte Fzg. ¹⁾ - ABS	24.0114-0102.1	414102		258 14,0 12,8
	2.0 i.e. 2.0 i.e. Turbo 2.5 D 2.5 TD		0182984 0182984 0182984 0182984	12.85 12.85 12.85 12.85		+ ABS / - gepanzerte Fzg. ⁴⁾ - gepanzerte Fahrzeuge ²⁾ + ABS	24.0120-0129.1	420129		257 20,0 18,2 V
	1.9 TD 2.0 i.e. 2.0 i.e. Turbo 2.5 D 2.5 TD	0182985 0182985 0182985 0182985		12.88 10.90 10.90 10.90 10.90		+ ABS + ABS / - gepanzerte Fzg. ⁴⁾ - gepanzerte Fahrzeuge ²⁾ + ABS	24.0122-0130.1	422130		257 22,0 20,2 V
	2.0 i.e. 2.0 i.e. Turbo			12.85 12.85	10.90 10.90	+ gepanzerte Fahrzeuge ³⁾ + gepanzerte Fahrzeuge ³⁾	24.0122-0145.1	422145		284 22,0 20,2 V +B
	1.6 1.9 TD 2.0 2.0 i.e. 2.0 i.e. Turbo 2.5 D 2.5 TD			12.85 12.88 12.85 12.85 12.85 12.85 12.85	10.90 10.90 10.90 10.90 10.90 10.90 10.90	+ ABS + ABS + ABS + ABS / + gepanzerte Fzg. ⁵⁾ + ABS / + gepanzerte Fzg. ⁵⁾ + ABS + ABS	24.3384-1608.5	240168		D=38, - Halter LUC
	1.6 1.9 TD 2.0 2.0 i.e. 2.0 i.e. Turbo 2.5 D 2.5 TD			12.85 12.88 12.85 12.85 12.85 12.85 12.85	10.90 10.90 10.90 10.90 10.90 10.90 10.90	- ABS - ABS - ABS - ABS / - gepanzerte Fzg. ¹⁾ - ABS / - gepanzerte Fzg. ¹⁾ - ABS - ABS	13.0460-3904.2	603904		21107 12,0 BDX
	1.6 1.9 TD 2.0 2.0 i.e. 2.0 i.e. Turbo 2.5 D 2.5 TD			12.85 12.88 12.85 12.85 12.85 12.85 12.85	10.90 10.90 10.90 10.90 10.90 10.90 10.90	+ ABS + ABS + ABS + ABS / + gepanzerte Fzg. ⁵⁾ + ABS / + gepanzerte Fzg. ⁵⁾ + ABS + ABS	13.0460-2962.2 13.0460-0072.2	602962 610072		20668 16,6 /S LUC Belagsatz-Zubehör LUC
	1.6 1.9 TD 2.0 2.0 i.e. 2.0 i.e. Turbo 2.5 D 2.5 TD			12.85 12.88 12.85 12.85 12.85 12.85 12.85	10.90 10.90 10.90 10.90 10.90 10.90 10.90	- gepanzerte Fahrzeuge ²⁾ - gepanzerte Fahrzeuge ²⁾	24.0110-0190.1	410190		252 10,0 9,0 +B
	2.0 i.e. 2.0 i.e. Turbo			12.85 12.85	10.90 10.90	+ gepanzerte Fahrzeuge ³⁾ + gepanzerte Fahrzeuge ³⁾	24.0110-0209.1	410209		251 10,0 9,0 +B
	1.6 1.9 TD 2.0 2.0 i.e. 2.0 i.e. Turbo 2.5 D 2.5 TD			12.85 12.88 12.85 12.85 12.85 12.85 12.85	10.90 10.90 10.90 10.90 10.90 10.90 10.90		24.3727-0514.2	580514		L=2950

1) - ABS/ - armoured vehicles / - ABS/ - veicoli blindati / - ABS/ - véhicule blindé / - ABS/ - vehiculo blindado
2) - armoured vehicles / - veicoli blindati / - véhicule blindé / - vehiculo blindado
3) + armoured vehicles / + veicoli blindati / + véhicule blindé / + vehiculo blindado
4) + ABS/ - armoured vehicles / + ABS/ - veicoli blindati / + ABS/ - véhicule blindé / + ABS/ - vehiculo blindado
5) + ABS/ + armoured vehicles / + ABS/ + veicoli blindati / + ABS/ + véhicule blindé / + ABS/ + vehiculo blindado



FIAT CROMA (85-90)													
	1.6 1.9 TD 2.0 2.0 i.e. 2.0 i.e. Turbo 2.5 D 2.5 TD			12.85 12.88 12.85 12.85 12.85 12.85 12.85	10.90 10.90 10.90 10.90 10.90 10.90 10.90			03.2525-2201.3	040026				Nz 25,40
FIAT CROMA (91-96)													
	1.6 1.9 TD 2.0 2.0 i.e. 2.0 i.e. 16V 2.0 i.e. Turbo 2.5 TD			11.90 11.90 11.90 11.90 12.92 11.90 11.90	12.92 10.96 12.92 10.96 10.96 10.96 10.96			13.0460-2952.2	602952				21185 19,4 +/WK/S LUC
	2.0 i.e. 2.0 i.e. 16V 2.0 i.e. Turbo 2.5 TD			11.90 12.92 11.90 11.90	10.96 10.96 10.96 10.96								- gepanzerte Fahrzeuge ¹⁾ - gepanzerte Fahrzeuge ¹⁾ - gepanzerte Fahrzeuge ¹⁾
	2.0 i.e. 2.0 i.e. Turbo 2.0 i.e. Turbo 2.5 i.e. V6			11.90 11.90 01.93 04.93	10.96 10.96 10.96 10.96			13.0460-2979.2	602979				21147 19,0 +/WK/S LUC
	2.0 i.e. 2.0 i.e. Turbo 2.0 i.e. Turbo 2.5 i.e. V6			11.90 11.90 01.93 04.93	10.96 10.96 10.96 10.96								+ gepanzerte Fahrzeuge ²⁾ + gepanzerte Fahrzeuge ²⁾
	1.6 1.9 TD 2.0 2.0 i.e. 1.9 TD 2.0 i.e. 2.0 i.e. 16V 2.0 i.e. Turbo 2.5 TD 2.0 i.e. 2.0 i.e. Turbo 2.5 i.e. V6			11.90 11.90 11.90 11.90 11.90 11.90 12.92 11.90 11.90 11.90 11.90 04.93	12.92 10.96 12.92 10.96 10.96 10.96 10.96 10.96 10.96 10.96 10.96 10.96			24.0114-0102.1	414102				258 14,0 12,8
	2.0 i.e. 2.0 i.e. 16V 2.0 i.e. Turbo 2.5 TD 2.0 i.e. 2.0 i.e. Turbo 2.5 i.e. V6			11.90 12.92 11.90 11.90 11.90 11.90 04.93	10.96 10.96 10.96 10.96 10.96 10.96 10.96			24.0122-0130.1	422130				257 22,0 20,2 V
	2.0 i.e. 2.0 i.e. Turbo 2.5 i.e. V6			11.90 11.90 04.93	10.96 10.96 10.96			24.0122-0145.1	422145				284 22,0 20,2 V +B
	2.0 i.e. 2.0 i.e. Turbo 2.5 i.e. V6			11.90 11.90 04.93	10.96 10.96 10.96			24.0122-0147.1	422147				284 22,0 20,2 V +B
	1.6 1.9 TD 2.0 2.0 i.e. 2.0 i.e. 16V 2.0 i.e. Turbo 2.5 i.e. V6 2.5 TD			11.90 11.90 11.90 11.90 12.92 11.90 04.93 11.90	12.92 10.96 12.92 10.96 10.96 10.96 10.96 10.96			24.3384-1608.5	240168				D=38, - Halter LUC
	2.0 i.e. 2.0 i.e. 16V 2.0 i.e. Turbo 2.5 i.e. V6 2.5 TD			11.90 12.92 11.90 11.90 04.93	10.96 10.96 10.96 10.96 10.96								+ ABS + ABS + ABS + ABS/ + gepanzerte Fzg. ⁵⁾ + ABS/ + gepanzerte Fzg. ⁵⁾ + ABS/ + gepanzerte Fzg. ⁵⁾ + ABS
	1.6 1.9 TD 2.0 2.0 i.e. 2.0 i.e. 16V 2.0 i.e. Turbo 2.5 TD			11.90 11.90 11.90 11.90 12.92 11.90 11.90	12.92 10.96 12.92 10.96 10.96 10.96 10.96			13.0460-3904.2	603904				21107 12,0 BDX
	2.0 i.e. 2.0 i.e. 16V 2.0 i.e. Turbo 2.5 TD			11.90 12.92 11.90 11.90	10.96 10.96 10.96 10.96								- ABS - ABS - ABS/ - gepanzerte Fzg. ³⁾ - ABS/ - gepanzerte Fzg. ³⁾ - ABS/ - gepanzerte Fzg. ³⁾ - ABS
	1.6 1.9 TD 2.0 2.0 i.e. 2.0 i.e. 16V 2.0 i.e. Turbo 2.5 i.e. V6 2.5 TD			11.90 11.90 11.90 11.90 12.92 11.90 04.93 11.90	12.92 10.96 12.92 10.96 10.96 10.96 10.96 10.96			13.0460-2962.2	602962				20668 16,6 /S LUC
	2.0 i.e. 2.0 i.e. 16V 2.0 i.e. Turbo 2.5 i.e. V6 2.5 TD			11.90 12.92 11.90 11.90 04.93	10.96 10.96 10.96 10.96 10.96			13.0460-0072.2	610072				Belagsatz-Zubehör LUC
	2.0 i.e. 2.0 i.e. Turbo			11.90 11.90	10.96 10.96								+ ABS + ABS
	1.6 1.9 TD 2.0 2.0 i.e. 2.0 i.e. 16V 2.0 i.e. Turbo 2.5 i.e. V6 2.5 TD			11.90 11.90 11.90 11.90 12.92 11.90 04.93 11.90	12.92 10.96 12.92 10.96 10.96 10.96 10.96 10.96			24.0110-0190.1	410190				252 10,0 9,0 +B
	2.0 i.e. 2.0 i.e. Turbo			11.90 11.90	10.96 10.96			24.0110-0209.1	410209				251 10,0 9,0 +B
	2.0 i.e. 2.0 i.e. 16V 2.0 i.e. Turbo 2.5 i.e. V6 2.5 TD			11.90 11.90 11.90 12.92 11.90	12.92 10.96 10.96 10.96 10.96			24.3727-0514.2	580514				L=2950
	2.0 i.e. 2.0 i.e. 16V 2.0 i.e. Turbo 2.5 i.e. V6 2.5 TD	2025078 2025078 2025078		11.90 11.90 11.90 12.92 11.90	12.92 10.96 10.96 10.96 10.96								L=2945
	2.0 i.e. 2.0 i.e. 16V 2.0 i.e. Turbo 2.5 i.e. V6 2.5 TD	2025079 2025079 2025079		11.90 12.92 11.90 04.93 11.90	10.96 10.96 10.96 10.96 10.96			24.3727-0545.2	580545				L=2945
	1.6 1.9 TD 2.0 2.0 i.e. 2.0 i.e. 16V 2.0 i.e. Turbo 2.5 i.e. V6 2.5 TD			11.90 11.90 11.90 11.90 12.92 11.90 04.93 11.90	12.92 10.96 12.92 10.96 10.96 10.96 10.96 10.96			03.2525-2201.3	040026				Nz 25,40



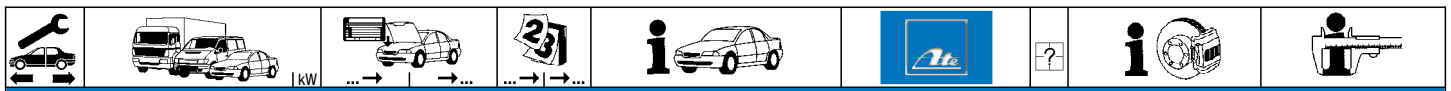























1) - armoured vehicles / - veicoli blindati / - véhicules blindé / - vehículo blindado
2) + armoured vehicles / + veicoli blindati / + véhicules blindé / + vehículo blindado
3) - ABS / - armoured vehicles / - ABS / - veicoli blindati / - ABS / - véhicules blindé / - ABS / - vehículo blindado
4) + ABS / - armoured vehicles / + ABS / - veicoli blindati / + ABS / - véhicules blindé / + ABS / - vehículo blindado
5) + ABS / + armoured vehicles / + ABS / + veicoli blindati / + ABS / + véhicules blindé / + ABS / + vehículo blindado































FIAT DUCATO (81-94)

	1.8 1.9 D 2.0 2.0 4x4 2.4 D 2.4 TD 2.5 D 2.5 TD 2.5 TD 4x4			09.81 02.87 09.81 06.90 05.81 01.86 01.86 07.90 01.86	01.94 01.94 01.94 01.94 12.85 06.90 01.94 01.94 01.94			24.2122-0801.3	010373			THz 22,20
	1.8 1.9 D 2.0 2.0 4x4 2.4 D 2.4 TD 2.5 D 2.5 TD 2.5 TD 4x4			09.81 02.87 09.81 06.90 05.81 01.86 01.86 07.90 01.86	01.94 01.94 01.94 01.94 12.85 06.90 01.94 01.94 01.94			13.0460-2901.2	602901			20741 19,0 +/WK/S LUC
	2.5 D 2.5 TD 2.5 TD 4x4			01.86 07.90 01.86	01.94 01.94 01.94	+ Maxi 1,8 t + Maxi 1,8 t + Maxi 1,8 t		13.0460-2902.2	602902			21205 19,0 +/WK/S LUC
	1.8 2.0 2.0 4x4 2.4 D		154461 154461 154461 154461	09.81 09.81 06.90 05.81				24.0113-0168.1	413168			256 13,0 11,0
	1.8 1.9 D 2.0 2.0 4x4 2.4 D 2.4 TD 2.5 D 2.5 TD 2.5 TD 4x4	154462 154462 154462 154462		02.87 01.94 01.94 01.94 12.85 01.86 01.86 07.90 01.86	01.94 01.94 01.94 01.94 12.85 06.90 01.94 01.94 01.94			24.0116-0105.1	416105			256 16,1 13,5 +B
	2.5 D 2.5 TD 2.5 TD 4x4			01.86 07.90 01.86	01.94 01.94 01.94	+ Maxi 1,8 t + Maxi 1,8 t + Maxi 1,8 t		24.0116-0106.1	416106			290 16,0 14,8
	1.8 2.0 2.4 D			09.81 09.81 05.81	08.84 08.84 08.84			24.5112-0362.3	330512	2		L=362
	1.8 1.9 D 2.0 2.0 4x4 2.4 D 2.4 TD 2.5 D 2.5 TD 2.5 TD 4x4			09.84 02.87 09.84 06.90 09.84 01.86 01.86 07.90 01.86	01.94 01.94 01.94 01.94 12.85 06.90 01.94 01.94 01.94			24.5112-0435.3 24.5112-0436.3	330524 330574	2 2		L=435, + Clip L=435, - Clip
	1.8 1.9 D 2.0 2.0 4x4 2.4 D 2.4 TD 2.5 D 2.5 TD 2.5 TD 4x4			09.81 02.87 09.81 06.90 05.81 01.86 01.86 07.90 01.86	01.94 01.94 01.94 01.94 12.85 06.90 01.94 01.94 01.94			24.5112-0260.3	330577	1	▣	L=260
	2.5 D 2.5 TD 2.5 TD 4x4			01.86 07.90 01.86	01.94 01.94 01.94	+ Maxi 1,8 t + Maxi 1,8 t + Maxi 1,8 t		24.5112-0285.3	330604	1	▣	L=285
	1.8 1.9 D 2.0 2.0 4x4 2.4 D 2.4 TD 2.5 D 2.5 TD 2.5 TD 4x4	77161 77161 77161 77161		02.87 01.94 01.94 01.94 12.85 01.86 01.86 07.90 01.86	01.94 01.94 01.94 01.94 12.85 06.90 01.94 01.94 01.94			24.3225-1101.3	020294			Rz 25,40 LUC
	2.5 D 2.5 TD 2.5 TD 4x4			01.86 07.90 01.86	01.94 01.94 01.94	+ Maxi 1,8 t + Maxi 1,8 t + Maxi 1,8 t		24.3226-1101.3	020296			Rz 26,99
	1.8 1.9 D 2.0 2.0 4x4 2.4 D 2.4 TD 2.5 D 2.5 TD 2.5 TD 4x4			09.81 02.87 09.81 06.90 05.81 01.86 01.86 07.90 01.86	01.94 01.94 01.94 01.94 12.85 06.90 01.94 01.94 01.94			03.0137-0330.2 03.0137-9216.2	650330 669216			254 x 57 HEB Bremsbacken-Zubehör LUC
	2.5 D 2.5 TD 2.5 TD 4x4			01.86 07.90 01.86	01.94 01.94 01.94	+ Maxi 1,8 t + Maxi 1,8 t + Maxi 1,8 t		03.0137-0269.2 03.0137-9169.2	650269 669169			254 x 57 HEB Bremsbacken-Zubehör



        						
FIAT DUCATO (81-94)						
	1.8 1.9 D 2.0 2.0 4x4 2.4 D 2.4 TD 2.5 D 2.5 TD 2.5 TD 4x4	77161 77161 77161 77161	09.81 01.94 02.87 01.94 09.81 01.94 06.90 01.94 05.81 12.85 01.86 06.90 01.86 01.94 07.90 01.94 01.86 01.94	24.0225-4002.1 480048 03.0520-0125.3 690125	254/255,6 x 63,5 25,40/254x57 TopKit LUC	
	1.8 1.9 D 2.0 2.0 4x4 2.4 D 2.4 TD 2.5 D 2.5 TD 2.5 TD 4x4	77161 77161 77161 77161	09.81 01.94 02.87 01.94 09.81 01.94 06.90 01.94 05.81 12.85 01.86 06.90 01.86 01.94 07.90 01.94 01.86 01.94	- Maxi 1,8 t - Maxi 1,8 t - Maxi 1,8 t	24.3727-0527.2 580527 1 ↓ 24.6513-1701.3 320160 24.3728-0515.2 590515	L=2566 BRL 3/10 (4) L=1200
	1.8 1.9 D 2.0 2.0 4x4 2.4 D 2.4 TD 2.5 D 2.5 TD 2.5 TD 4x4		09.81 01.94 02.87 01.94 09.81 01.94 06.90 01.94 05.81 12.85 01.86 06.90 01.86 01.94 07.90 01.94 01.86 01.94			
	1.8 2.0 2.4 D		09.81 12.84 09.81 12.84 05.81 12.84			
	1.8 1.9 D 2.0 2.0 4x4 2.4 D 2.4 TD 2.5 D 2.5 TD 2.5 TD 4x4		09.81 01.94 02.87 01.94 09.81 01.94 06.90 01.94 05.81 01.94 01.86 01.94 07.90 01.94 07.90 01.94 01.86 01.94			
FIAT DUNA (87-90)						
	1.1 1.3 1.7 D		03.87 12.90 03.87 12.90 03.87 12.90	13.0460-5409.2 605409 13.0460-5410.2 605410	21193 18,0 + ATE 21195 18,0 +/WK ATE	
	1.1 1.3 1.7 D		03.87 12.90 03.87 12.90 03.87 12.90	24.0112-0122.1 412122	240 12,0 10,8	
	1.1 1.3 1.7 D		03.87 12.90 03.87 12.90 03.87 12.90	24.3219-1103.3 020408	Rz 19,05	
	1.1 1.3 1.7 D		03.87 12.90 03.87 12.90 03.87 12.90	03.0137-0015.2 650015 03.0137-9021.2 669021	185 x 31 AUT FI Bremsbacken-Zubehör FI	
	1.1 1.3 1.7 D		03.87 12.90 03.87 12.90 03.87 12.90	24.0218-5001.1 480012	185/186,8 x 37	
	1.1 1.3 1.7 D		03.87 12.90 03.87 12.90 03.87 12.90	24.3727-0517.2 580517 1 ↓	L=2833	
	1.1 1.3 1.7 D		03.87 12.90 03.87 12.90 03.87 12.90	24.6513-0801.3 320117	BRL 1/3 (2)	
FIAT FIORINO (88-93)						
	1.1 1.3 1.5 1.7 D		09.88 08.93 09.88 08.93 09.88 08.93 09.88 08.93	24.2120-0802.3 010363	THz 20,64 ATE	
	1.1 1.3 1.5 1.7 D		09.88 08.93 09.88 08.93 09.88 08.93 09.88 08.93	13.0460-5409.2 605409	21193 18,0 + ATE	
	1.1 1.3 1.5 1.7 D		09.88 08.93 09.88 08.93 09.88 08.93 09.88 08.93	24.0112-0122.1 412122	240 12,0 10,8	
	1.1 1.3 1.5 1.7 D		09.88 08.93 09.88 08.93 09.88 08.93 09.88 08.93	24.3219-1103.3 020408	Rz 19,05	
	1.1 1.3 1.5 1.7 D		09.88 08.93 09.88 08.93 09.88 08.93 09.88 08.93	03.0137-0015.2 650015 03.0137-9021.2 669021	185 x 31 AUT FI Bremsbacken-Zubehör FI	

								
FIAT FIORINO (88-93)								
	1.1 1.3 1.5 1.7 D			09.88 09.88 09.88 09.88	08.93 08.93 08.93 08.93	24.0218-5001.1	480012	185/186,8 x 37
	1.1 1.3 1.5 1.7 D			09.88 09.88 09.88 09.88	08.93 08.93 08.93 08.93	24.3727-0517.2	580517	L=2833
	1.1 1.3 1.5 1.7 D		8220596	09.88 09.88 09.88 09.88	08.93 08.93 08.93 08.93	24.6513-0801.3	320117	BRL 1/3 (2)
FIAT PANDA (80-85)								
	30 34 45 4x4	6166304 6166304 6166304	6223907 6223907 6223907 5242876	09.83		24.2119-0827.3	010350	THz 19,05
	30 34 45 4x4	6223908 6223908 6223908 5242877			12.85 12.85 12.85 12.85	24.2119-0826.3	010349	THz 19,05
	30 34 45 4x4			05.80 05.80 05.80	08.82 08.82 08.82	13.0460-3936.2	603936	20073 17,3 BDX
	30 34 45 4x4			09.82 09.82 09.82 09.83	12.85 12.85 12.85 12.85	13.0460-3939.2 13.0460-0410.2	603939 610410	20775 18,0 /WE Belagsatz-Zubehör BDX BDX
	30 34 45 4x4			05.80 05.80 05.80 09.83	12.85 12.85 12.85 12.85	24.0111-0130.1	411130	227 10,8 9,0 +B
	30 34 45			05.80 05.80 05.80	08.82 08.82 08.82	24.5209-0280.3	330044	L=280
	30 34 45 4x4	6261412 6261412 6261412		09.83	12.85 12.85 12.85	24.3219-0803.3	020183	Rz 19,05
	30 34 45 4x4			05.80 05.80 05.80 09.83	12.85 12.85 12.85 12.85	03.0137-0015.2 03.0137-9021.2	650015 669021	185 x 31 AUT Bremsbacken-Zubehör FI FI
	30 34 45 4x4			05.80 05.80 05.80 09.83	12.85 12.85 12.85 12.85	24.0218-5001.1	480012	185/186,8 x 37
	30 34 45 4x4	6261412 6261412 6261412		09.83	12.85 12.85 12.85	03.0420-0319.3	680319	19,05/185x31 Kit FI
	30 34 45 4x4			05.80 05.80 05.80 09.83	12.85 12.85 12.85 12.85	24.3727-0503.2	580503	L=2670
	30 34 45 4x4	6166304 6166304 6166304	6261411 6261411 6261411	09.83	12.85	24.6046-0801.3	320116	BR 4/6 (2)
FIAT REGATA (83-89)								
	1.3 1.5 1.6 1.7 D 1.9 D 1.9 TD		7128841 7128841 7128841 7128841 7128841 7128841	09.83 09.83 09.83 09.83 04.84 05.86		24.2119-0827.3	010350	THz 19,05
	1.3 1.5 1.6 1.7 D 1.9 D 1.9 TD	7128842 7128842 7128842 7128842 7128842 7128842			09.89 09.89 09.89 03.89 09.89 09.89	24.2120-0801.3	010362	THz 20,64
	1.5 Kombi 1.6 Kombi 1.9 D Kombi 1.9 TD Kombi			09.83 09.83 04.84 05.86	09.89 09.89 09.89 09.89	24.3481-1703.5 24.3481-1704.5	240051 240052	D=48, - Halter LUC D=48, - Halter LUC
	1.3 1.5 Lim. 1.6 Lim. 1.7 D 1.9 D Lim. 1.9 TD Lim.			09.83 09.83 09.83 09.83 04.84 05.86	09.89 09.89 09.89 03.89 09.89 09.89	13.0460-3940.2 13.0460-0410.2	603940 610410	20775 18,0 /WK Belagsatz-Zubehör BDX BDX

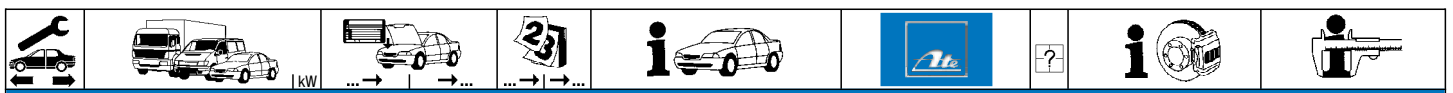

























FIAT REGATA (83-89)

	1.5 Kombi 1.6 Kombi 1.9 D Kombi 1.9 TD Kombi		09.83 09.83 04.84 05.86	09.89 09.89 09.89 09.89	13.0460-2941.2	602941		20839 17,0 /WK/S	LUC
	1.3 1.5 Lim. 1.6 (90) Lim. 1.7 D 1.9 D Lim. 1.9 TD Lim.		09.83 09.83 09.83 09.83 04.84 05.86	09.89 09.89 09.89 03.89 09.89 09.89	24.0111-0130.1	411130		227 10,8 9,0 +B	
	1.5 Kombi 1.6 (100 S) Lim. 1.6 Kombi 1.9 D Kombi 1.9 TD Kombi		09.83 09.83 09.83 04.84 05.86	09.89 09.89 09.89 09.89 09.89	24.0112-0112.1	412112		257 12,0 10,8	
	1.3 1.5 1.6 1.7 D 1.9 D 1.9 TD		09.83 09.83 09.83 09.83 04.84 05.86	09.89 09.89 09.89 03.89 09.89 09.89	24.3219-0803.3	020183		Rz 19,05	
	1.3 1.5 1.6 1.7 D 1.9 D 1.9 TD		09.83 09.83 09.83 09.83 04.84 05.86	09.89 09.89 09.89 03.89 09.89 09.89	03.0137-0015.2 03.0137-9021.2	650015 669021		185 x 31 AUT Bremsbacken-Zubehör	FI FI
	1.3 1.5 1.6 1.7 D 1.9 D 1.9 TD		09.83 09.83 09.83 09.83 04.84 05.86	09.89 09.89 09.89 03.89 09.89 09.89	24.0218-5001.1	480012		185/186,8 x 37	
	1.3 1.5 1.6 1.7 D 1.9 D 1.9 TD		09.83 09.83 09.83 09.83 04.84 05.86	09.89 09.89 09.89 03.89 09.89 09.89	03.0420-0319.3	680319		19,05/185x31 Kit	FI

FIAT RITMO (78-88)

	1.1 1.3 1.5 1.7 D 60		05.85 05.85 05.85 10.82 10.82	12.85 12.85 12.85 12.85 04.85	24.2119-0827.3	010350		THz 19,05	
	1.1 1.3 1.5 1.7 D 1.9 TD 105 TC 125 TC 130 TC		01.86 01.86 01.86 01.86 06.86 05.81 09.81 07.83	09.87 09.87 09.87 09.87 06.88 12.85 12.86 09.87	24.2120-0801.3	010362		THz 20,64	
	1.7 D 60 65 75		03.80 09.78 09.78 09.78	08.82 08.82 08.82 08.82	13.0460-3936.2	603936		20073 17,3	BDX
	1.1 1.3 1.5 1.7 D 60 1.9 TD 105 TC		05.85 05.85 05.85 09.82 09.82 06.86 05.81	09.87 09.87 09.87 09.87 04.85 06.88 12.85	13.0460-3940.2 13.0460-0410.2	603940 610410		20775 18,0 /WK Belagsatz-Zubehör	BDX BDX
	1.1 1.3 1.5 1.7 D 60 65 75 105 TC 1.9 TD 105 TC		05.85 05.85 05.85 03.80 09.78 09.78 09.78 05.81 06.86 09.83	09.87 09.87 09.87 09.87 04.85 04.85 09.82 08.83 06.88 12.85	24.0111-0130.1	411130		227 10,8 9,0 +B	
	1.1 1.3 1.5 1.7 D 60 65 75 105 TC 1.9 TD 105 TC		05.85 05.85 05.85 03.80 09.78 09.78 09.78 05.81 06.86 09.83	09.87 09.87 09.87 09.87 04.85 04.85 09.82 08.83 06.88 12.85	24.0111-0129.1	411129		251 11,0 9,5	
	1.1 1.3 1.5 1.7 D 60 65 75 105 TC 1.9 TD 105 TC		05.85 05.85 05.85 03.80 09.78 09.78 09.78 05.81 06.86 09.83	09.87 09.87 09.87 09.87 04.85 04.85 09.82 08.83 06.88 12.85	24.0112-0112.1	412112		257 12,0 10,8	
	1.7 D 60 65		03.80 09.78 09.78	04.85 04.85 09.82	24.5209-0280.3	330044	2	L=280	
	1.7 D 60 65 75		08.82 08.82 08.82 08.82	04.85 04.85 09.82 09.82	24.3217-1115.3	020310		Rz 17,46	FI
	1.1 1.3		05.85 05.85	09.87 09.87	24.3219-0803.3	020183		Rz 19,05	













        					
FIAT RITMO (78-88)					
	1.5 1.7 D 1.9 TD 105 TC 125 TC 130 TC	05.85 09.87 05.85 09.87 06.86 06.88 05.81 12.85 09.81 12.86 07.83 06.88	24.3219-0803.3 020183		Rz 19,05
	1.1 1.3 1.5 1.7 D 1.9 TD 105 TC 125 TC 130 TC 60 65 75	05.85 09.87 05.85 09.87 05.85 09.87 03.80 09.87 06.86 06.88 05.81 12.85 09.81 12.86 07.83 06.88 09.78 04.85 09.78 09.82 09.78 09.82	03.0137-0015.2 650015 03.0137-9021.2 669021		185 x 31 AUT Bremsbacken-Zubehör FI FI
	1.1 1.3 1.5 1.7 D 1.9 TD 105 TC 125 TC 130 TC 60 65 75	05.85 09.87 05.85 09.87 05.85 09.87 03.80 09.87 06.86 06.88 05.81 12.85 09.81 12.86 07.83 06.88 09.78 04.85 09.78 09.82 09.78 09.82	24.0218-5001.1 480012		185/186,8 x 37
	1.7 D 60 65 75	08.82 04.85 08.82 04.85 08.82 09.82 08.82 09.82	03.0420-0917.3 680917		17,46/185x31 Kit FI
	1.1 1.3 1.5 1.7 D 1.9 TD 105 TC 125 TC 130 TC	05.85 09.87 05.85 09.87 05.85 09.87 05.85 09.87 06.86 06.88 05.81 12.85 09.81 12.86 07.83 06.88	03.0420-0319.3 680319		19,05/185x31 Kit FI
FIAT TALENTO (88-94)					
	1.9 D 2.0	10.88 12.94 07.90 12.94	24.2122-0801.3 010373		THz 22,20
	1.9 D 2.0	10.88 12.94 07.90 12.94	13.0460-2901.2 602901		20741 19,0 +/WK/S LUC
	1.9 D 2.0	10.88 12.94 07.90 12.94	24.0116-0105.1 416105		256 16,1 13,5 +B
	1.9 D 2.0	10.88 12.94 07.90 12.94	24.5112-0435.3 330524 24.5112-0436.3 330574	2 2	L=435, + Clip L=435, - Clip
	1.9 D 2.0	10.88 12.94 07.90 12.94	24.5112-0315.3 330509	1	L=315
	1.9 D 2.0	10.88 12.94 07.90 12.94	03.0137-0330.2 650330 03.0137-9216.2 669216		254 x 57 HEB Bremsbacken-Zubehör LUC LUC
	1.9 D 2.0	10.88 12.94 07.90 12.94	24.0225-4002.1 480048		254/255,6 x 63,5
	1.9 D 2.0	10.90 12.94 10.90 12.94	24.3728-0515.2 590515		L=1200
FIAT TEMPRA (90-93)					
	1.4 i.e. 1.6 i.e. 1.8 i.e. 1.9 D 1.9 TD 2.0 i.e.	03.90 04.93 03.90 04.93 03.90 04.93 03.90 04.93 03.90 04.93 03.90 04.93	24.2120-1710.3 010468		- ABS THz 20,64
	1.4 i.e. Lim. 1.6 i.e. Lim.	03.90 04.93 03.90 04.93	24.0101-3601.2 260044		Bremssattel-Zubehör LUC
	1.4 i.e. Kombi 1.4 i.e. Lim. 1.4 i.e. Lim. 1.6 i.e. Kombi 1.6 i.e. Lim. 1.6 i.e. Lim. 1.8 i.e. Lim. 1.9 D 1.9 TD Lim.	03.90 04.93 03.90 04.93 03.90 04.93 03.90 04.93 03.90 04.93 03.90 04.93 03.90 04.93 03.90 04.93 03.90 04.93	24.3481-1703.5 240051 24.3481-1704.5 240052 24.0101-4301.2 260047	<input type="checkbox"/> <input type="checkbox"/>	D=48, - Halter D=48, - Halter Bremssattel-Zubehör LUC LUC LUC





















1) - ABS/ + manual transmission / - ABS/+ scatola camb.velocità / - ABS/ + transmission mécanique / - ABS/ + cambio de velocidad

2) + ABS/ + manual transm. / + ABS/+ scatola camb.velocità / + ABS/ + transmission mécanique / + ABS/ + cambio de velocidad

3) + autom.transmission / + scatola cambio automatico / + transmission automatique / + cambio automático

FIAT TEMPRA (90-93)										
	1.4 i.e. Lim. 1.6 i.e. Lim.	03.90 03.90	04.93 04.93	- ABS/ + Schaltgetriebe ¹⁾ - ABS/ + Schaltgetriebe ¹⁾	13.0460-2948.2 602948				21100 16,7 +/WK/S	LUC
	1.4 i.e. Kombi 1.4 i.e. Lim. 1.4 i.e. Lim. 1.6 i.e. Kombi 1.6 i.e. Lim. 1.6 i.e. Lim. 1.8 i.e. 1.9 D 1.9 TD 2.0 i.e.	03.90 03.90 03.90 03.90 03.90 03.90 03.90 03.90 03.90 03.90	04.93 04.93 04.93 04.93 04.93 04.93 04.93 04.93 04.93 04.93	+ ABS/ + Schaltgetriebe ²⁾ + Automatikgetriebe ³⁾ + ABS/ + Schaltgetriebe ²⁾ + Automatikgetriebe ³⁾	13.0460-2949.2 602949				20833 17,0 +/WK/S	LUC
	1.4 i.e. Lim. 1.6 i.e. Lim.	03.90 03.90	04.93 04.93	- ABS/ + Schaltgetriebe ¹⁾ - ABS/ + Schaltgetriebe ¹⁾	24.0111-0119.1 411119				241 11,0 9,2 +B	
	1.4 i.e. Kombi 1.4 i.e. Lim. 1.4 i.e. Lim. 1.6 i.e. Kombi 1.6 i.e. Lim. 1.6 i.e. Lim. 1.8 i.e. Lim. 1.9 D 1.9 TD Lim.	03.90 03.90 03.90 03.90 03.90 03.90 03.90 03.90 03.90	04.93 04.93 04.93 04.93 04.93 04.93 04.93 04.93 04.93	+ ABS/ + Schaltgetriebe ²⁾ + Automatikgetriebe ³⁾ + ABS/ + Schaltgetriebe ²⁾ + Automatikgetriebe ³⁾	24.0112-0127.1 412127				258 12,0 10,2 +B	
	1.8 i.e. Kombi 1.9 TD Kombi 2.0 i.e.	03.90 03.90 03.90	04.93 04.93 04.93		24.0120-0142.1 420142 24.0320-0142.1 520142				258 20,0 18,2 V L +B 258 20,0 18,2 V L +B PD	
	1.4 i.e. 1.6 i.e.	03.90 03.90	04.93 04.93		24.5112-0360.3 330513 24.5112-0384.3 330651		2 2		L=360 L=387	
	1.4 i.e. 1.6 i.e. 1.8 i.e. 1.9 D 1.9 TD 2.0 i.e.	03.90 03.90 03.90 03.90 03.90 03.90	04.93 04.93 04.93 04.93 04.93 04.93	+ ABS + ABS + ABS + ABS + ABS	24.3344-1703.5 240117 24.3344-1704.5 240118 24.0101-3601.2 260044		<input type="checkbox"/> <input type="checkbox"/>		D=34, - Halter D=34, - Halter Bremsattel-Zubehör	LUC LUC LUC
	1.4 i.e. 1.6 i.e. 1.8 i.e. 1.9 D 1.9 TD 2.0 i.e.	03.90 03.90 03.90 03.90 03.90 03.90	04.93 04.93 04.93 04.93 04.93 04.93	+ ABS + ABS + ABS + ABS + ABS	13.0460-2951.2 602951 13.0460-0072.2 610072				21103 14,2 /S Belagsatz-Zubehör	LUC LUC
	1.4 i.e. 1.6 i.e. 1.8 i.e. 1.9 D 1.9 TD 2.0 i.e.	03.90 03.90 03.90 03.90 03.90 03.90	04.93 04.93 04.93 04.93 04.93 04.93	+ ABS + ABS + ABS + ABS + ABS	24.0111-0119.1 411119				241 11,0 9,2 +B	
	1.4 i.e. Lim. 1.6 i.e. Lim.	03.90 03.90	04.93 04.93	- ABS/ + Schaltgetriebe ¹⁾ - ABS/ + Schaltgetriebe ¹⁾	24.3219-1102.3 020190				Rz 19,05	BDX
	1.4 i.e. Lim. 1.6 i.e. Lim.	03.90 03.90	04.93 04.93	- ABS/ + Schaltgetriebe ¹⁾ - ABS/ + Schaltgetriebe ¹⁾	03.0137-0207.2 650207 03.0137-9088.2 669088				180 x 32 Bremsbacken-Zubehör	BDX BDX
	1.4 i.e. Kombi 1.4 i.e. Lim. 1.6 i.e. Kombi 1.6 i.e. Lim. 1.8 i.e. 1.9 D 1.9 TD	03.90 03.90 03.90 03.90 03.90 03.90 03.90	04.93 04.93 04.93 04.93 04.93 04.93 04.93	- ABS - ABS/ + Automatikgetriebe ⁴⁾ - ABS - ABS/ + Automatikgetriebe ⁴⁾ - ABS - ABS	03.0137-0208.2 650208 03.0137-9081.2 669081				228 x 42 HEB Bremsbacken-Zubehör	
	1.4 i.e. Lim. 1.6 i.e. Lim.	03.90 03.90	04.93 04.93	- ABS/ + Schaltgetriebe ¹⁾ - ABS/ + Schaltgetriebe ¹⁾	24.0218-0011.1 480006				180/181,4 x 40	
	1.4 i.e. Kombi 1.4 i.e. Lim. 1.6 i.e. Kombi 1.6 i.e. Lim. 1.8 i.e. 1.9 D 1.9 TD	03.90 03.90 03.90 03.90 03.90 03.90 03.90	04.93 04.93 04.93 04.93 04.93 04.93 04.93	- ABS - ABS/ + Automatikgetriebe ⁴⁾ - ABS - ABS/ + Automatikgetriebe ⁴⁾ - ABS - ABS	24.0222-8018.1 480078				228/230 x 48	
	1.4 i.e. Lim. 1.6 i.e. Lim.	03.90 03.90	04.93 04.93	- ABS/ + Schaltgetriebe ¹⁾ - ABS/ + Schaltgetriebe ¹⁾	03.0520-1219.3 691219				19,05/180x32 TopKit	BDX
	1.4 i.e. Lim. 1.6 i.e. Lim.	03.90 03.90	04.93 04.93	- ABS/ + Schaltgetriebe ¹⁾ - ABS/ + Schaltgetriebe ¹⁾	24.3727-0511.2 580511 24.3727-0510.2 580510		<input type="checkbox"/> <input type="checkbox"/>		L=1415 L=1375	
	1.4 i.e. Kombi 1.4 i.e. Lim. 1.6 i.e. Kombi 1.6 i.e. Lim. 1.8 i.e. 1.9 D 1.9 TD	03.90 03.90 03.90 03.90 03.90 03.90 03.90	04.93 04.93 04.93 04.93 04.93 04.93 04.93	- ABS - ABS/ + Automatikgetriebe ⁴⁾ - ABS - ABS/ + Automatikgetriebe ⁴⁾ - ABS - ABS	24.3727-0513.2 580513		<input type="checkbox"/>		L=1445	
	1.4 i.e. 1.6 i.e. 1.8 i.e. 1.9 D	03.90 03.90 03.90 03.90	04.93 04.93 04.93 04.93	+ ABS + ABS + ABS + ABS	24.3727-0521.2 580521 24.3727-0006.2 580006		<input type="checkbox"/> <input type="checkbox"/>		L=1517 L=1460	

1) - ABS/ + manual transmission / - ABS/+ scatola camb.velocità / - ABS/ + transmission mécanique / - ABS/ + cambio de velocidad
2) + ABS/ + manual transm. / + ABS/+ scatola camb.velocità / + ABS/ + transmission mécanique / + ABS/ + cambio de velocidad
3) + autom.transmission / + scatola cambio automatico / + transmission automatique / + cambio automático
4) - ABS/ + autom.transmission / - ABS/ + scatola cambio autom. / - ABS/ + transmission automatique / - ABS/ + cambio automático

										
FIAT TEMPRA (90-93)										
	1.9 TD 2.0 i.e.			03.90 03.90	04.93 04.93	+ ABS	24.3727-0521.2 24.3727-0006.2	580521 580006	<input type="checkbox"/> <input type="checkbox"/>	L=1517 L=1460
	1.4 i.e. 1.6 i.e. 1.8 i.e. 2.0 i.e.			03.90 03.90 03.90 03.90	04.93 04.93		24.3728-0503.2	590503	<input type="checkbox"/>	L=729
			7003766 7003766							
	1.8 i.e. 1.9 D 1.9 TD 2.0 i.e.	7003767		03.90 03.90	04.93 04.93		24.3728-0502.2	590502	<input type="checkbox"/>	L=764
		7003767								
FIAT TEMPRA (93-96)										
	1.4 i.e. Kombi 1.4 i.e. Lim. 1.6 i.e. Kombi 1.6 i.e. Lim. 1.8 i.e. Lim. 1.9 D Kombi 1.9 D Lim. 1.9 TD Lim.			05.93 05.93 05.93 05.93 05.93 05.93 05.93	09.96 09.96 09.96 09.96 09.96 09.96 09.96	+ ABS + ABS	24.3541-1748.5	240222	<input type="checkbox"/>	D=54, - Halter LUC
	1.4 i.e. 1.6 i.e. 1.8 i.e. 1.9 D 1.9 TD 2.0 i.e. 2.0 i.e. 4x4			05.93 05.93 05.93 05.93 05.93 05.93 05.93	09.96 09.96 09.96 09.96 09.96 09.96 09.96		13.0460-2949.2	602949	<input type="checkbox"/>	20833 17,0 +/WK/S LUC
	1.4 i.e. Lim. 1.6 i.e. Lim. 1.9 D Lim.			05.93 05.93 05.93	09.96 09.96 09.96	- ABS - ABS/ + Schaltgetriebe 2) - ABS	24.0111-0119.1	411119	<input type="checkbox"/>	241 11,0 9,2 +B
	1.4 i.e. Kombi 1.4 i.e. Lim. 1.6 i.e. Kombi 1.6 i.e. Lim. 1.8 i.e. Lim. 1.9 D Kombi 1.9 D Lim. 1.9 TD Lim.			05.93 05.93 05.93 05.93 05.93 05.93 05.93	09.96 09.96 09.96 09.96 09.96 09.96 09.96	+ ABS + ABS + ABS/ + Automatikgetriebe 1)	24.0112-0127.1	412127	<input type="checkbox"/>	258 12,0 10,2 +B
	1.8 i.e. Kombi 1.9 TD Kombi 2.0 i.e. 2.0 i.e. 4x4			05.93 05.93 05.93 05.93	09.96 09.96 09.96 09.96		24.0120-0142.1 24.0320-0142.1	420142 520142	<input type="checkbox"/>	258 20,0 18,2 V L +B 258 20,0 18,2 V L +B PD
	1.4 i.e. 1.6 i.e. 1.8 i.e. 1.9 D 1.9 TD 2.0 i.e. 2.0 i.e. 4x4			05.93 05.93 05.93 05.93 05.93 05.93 05.93	09.96 09.96 09.96 09.96 09.96 09.96 09.96	+ ABS + ABS + ABS + ABS + ABS	24.3344-1703.5 24.3344-1704.5 24.0101-3601.2	240117 240118 260044	<input type="checkbox"/> <input type="checkbox"/>	D=34, - Halter D=34, - Halter Bremsattel-Zubehör LUC LUC LUC
	1.4 i.e. 1.6 i.e. 1.8 i.e. 1.9 D 1.9 TD 2.0 i.e. 2.0 i.e. 4x4			05.93 05.93 05.93 05.93 05.93 05.93 05.93	09.96 09.96 09.96 09.96 09.96 09.96 09.96	+ ABS + ABS + ABS + ABS + ABS	13.0460-2951.2 13.0460-0072.2	602951 610072	<input type="checkbox"/>	21103 14,2 /S Belagsatz-Zubehör LUC LUC
	1.4 i.e. 1.6 i.e. 1.8 i.e. 1.9 D 1.9 TD 2.0 i.e. 2.0 i.e. 4x4			05.93 05.93 05.93 05.93 05.93 05.93 05.93	09.96 09.96 09.96 09.96 09.96 09.96 09.96	+ ABS + ABS + ABS + ABS + ABS	24.0111-0119.1	411119	<input type="checkbox"/>	241 11,0 9,2 +B
	1.8 i.e. 2.0 i.e. 2.0 i.e. 4x4			05.93 05.93 05.93	09.96 09.96 09.96		24.5228-0223.3	330530	2	L=223
	1.4 i.e. 1.6 i.e. 1.9 D			05.93 05.93 05.93	09.96 09.96 09.96	- ABS - ABS/ + Schaltgetriebe 2) - ABS	24.3222-1701.3	020376	<input type="checkbox"/>	Rz 22,20
	1.6 i.e. 1.8 i.e. 1.9 TD			05.93 05.93 05.93	09.96 09.96 09.96	- ABS/ + Automatikgetriebe 3) - ABS - ABS	24.3220-1116.3	020313	<input type="checkbox"/>	Rz 20,64
	1.4 i.e. Lim. 1.6 i.e. Lim. 1.9 D Lim.			05.93 05.93 05.93	09.96 09.96 09.96	- ABS - ABS/ + Schaltgetriebe 2) - ABS	03.0137-0207.2 03.0137-9088.2	650207 669088	<input type="checkbox"/>	180 x 32 Bremsbacken-Zubehör BDX BDX
	1.4 i.e. Kombi 1.6 i.e. Kombi 1.6 i.e. Lim. 1.8 i.e. 1.9 D Kombi 1.9 TD			05.93 05.93 05.93 05.93 05.93 05.93	09.96 09.96 09.96 09.96 09.96 09.96	- ABS - ABS - ABS/ + Automatikgetriebe 3) - ABS - ABS - ABS	03.0137-0208.2 03.0137-9081.2	650208 669081	<input type="checkbox"/>	228 x 42 HEB Bremsbacken-Zubehör

1) + ABS/ + autom.transmission / + ABS/ + scatola cambio autom. / + ABS/ + transmission automatique / + ABS/ + cambio automático

2) - ABS/ + manual transmission / - ABS/ + scatola camb.velocità / - ABS/ + transmission mécanique / - ABS/ + cambio de velocidad

3) - ABS/ + autom.transmission / - ABS/ + scatola cambio autom. / - ABS/ + transmission automatique / - ABS/ + cambio automático

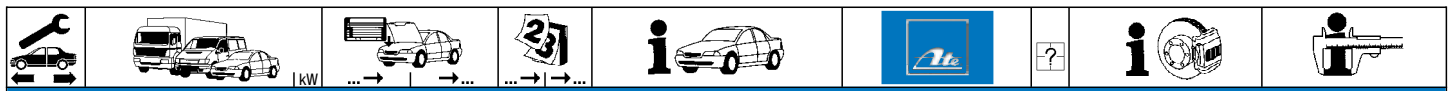

FIAT TEMPRA (93-96)

	1.4 i.e. Lim.		05.93	09.96	- ABS	24.0218-0011.1	480006			180/181,4 x 40											
	1.6 i.e. Lim.		05.93	09.96	- ABS/ + Schaltgetriebe 1)																
	1.9 D Lim.		05.93	09.96	- ABS																
	1.4 i.e. Kombi		05.93	09.96	- ABS	24.0222-8018.1	480078			228/230 x 48											
	1.6 i.e. Kombi		05.93	09.96	- ABS																
	1.6 i.e. Lim.		05.93	09.96	- ABS/ + Automatikgetriebe 2)																
	1.8 i.e.		05.93	09.96	- ABS																
	1.9 D Kombi		05.93	09.96	- ABS																
	1.9 TD		05.93	09.96	- ABS																
	1.4 i.e. Lim.		05.93	09.96	- ABS	03.0420-4322.3	684322			22,20/180x32 Kit BDX											
	1.6 i.e. Lim.		05.93	09.96	- ABS/ + Schaltgetriebe 1)																
	1.9 D Lim.		05.93	09.96	- ABS																
	1.6 i.e. Lim.		05.93	09.96	- ABS/ + Automatikgetriebe 2)	03.0420-4520.3	684520			20,64/228x42 Kit											
	1.8 i.e.		05.93	09.96	- ABS																
	1.9 TD		05.93	09.96	- ABS																
		1.4 i.e. Lim.		05.93	09.96						- ABS	24.3727-0511.2	580511	<input type="checkbox"/>		L=1415					
		1.6 i.e. Lim.		05.93	09.96						- ABS/ + Schaltgetriebe 1)						24.3727-0510.2	580510	<input type="checkbox"/>		L=1375
		1.4 i.e. Kombi		05.93	09.96						- ABS										
1.6 i.e. Kombi			05.93	09.96	- ABS																
1.6 i.e. Lim.			05.93	09.96	- ABS/ + Automatikgetriebe 2)																
1.8 i.e.		05.93	09.96	- ABS																	
1.9 D		05.93	09.96	- ABS																	
	1.9 TD		05.93	09.96	- ABS	24.3727-0521.2	580521	<input type="checkbox"/>		L=1517											
	1.4 i.e.		05.93	09.96	+ ABS						24.3727-0006.2	580006	<input type="checkbox"/>		L=1460						
	1.6 i.e.		05.93	09.96	+ ABS																
	1.8 i.e.		05.93	09.96	+ ABS																
	1.9 D		05.93	09.96	+ ABS																
	1.9 TD		05.93	09.96	+ ABS																
2.0 i.e.		05.93	09.96																		
	1.4 i.e.	↖	05.93	09.96		24.3728-0503.2	590503			L=729											
	1.6 i.e.	↖	05.93	09.96																	
	1.8 i.e.	↖	05.93	09.96							24.3728-0502.2	590502			L=764						
	1.9 TD	↖	05.93	09.96																	
	2.0 i.e.	↖	05.93	09.96																	
2.0 i.e. 4x4	↖	05.93	09.96																		

FIAT TIPO (88-93)

	1.1	↖	01.88	04.93		24.2120-1710.3	010468			- ABS	Thz 20,64															
	1.4	↖	01.88	04.93																						
	1.4 i.e.	↖	01.88	04.93																						
	1.6	↖	01.88	04.93																						
	1.6 i.e.	↖	01.88	04.93																						
	1.7 D	↖	01.88	04.93																						
	1.8 i.e.	↖	03.90	04.93																						
	1.8 i.e. 16V	↖101	10.89	04.93																						
	1.9 D	↖	01.88	04.93																						
	1.9 TD	↖	01.88	04.93																						
	2.0 i.e.	↖	09.90	04.93																						
2.0 i.e. 16V	↖	01.91	04.93																							
	1.1		01.88	04.93	- ABS	24.0101-3601.2	260044				Bremsattel-Zubehör LUC															
	1.4		01.88	04.93	- ABS																					
	1.4 i.e.		01.88	04.93	- ABS																					
	1.6		01.88	04.93	- ABS/ + Schaltgetriebe 1)																					
	1.6 i.e.	57	01.88	04.93	- ABS/ + Schaltgetriebe 1)																					
	1.7 D		01.88	04.93	- ABS																					
	1.9 D		01.88	04.93	- ABS																					
	1.1		01.88	04.93	+ ABS							24.3481-1703.5	240051	<input type="checkbox"/>	<input type="checkbox"/>	D=48, - Halter LUC										
	1.4		01.88	04.93	+ ABS												24.3481-1704.5	240052	<input type="checkbox"/>	<input type="checkbox"/>	D=48, - Halter LUC					
	1.4 i.e.		01.88	04.93	+ ABS																	24.0101-4301.2	260047	<input type="checkbox"/>	<input type="checkbox"/>	Bremsattel-Zubehör LUC
	1.6		01.88	04.93	+ ABS/ + Schaltgetriebe 3)																					
1.6		01.88	04.93	+ Automatikgetriebe 4)																						
1.6 i.e.	57	01.88	04.93	+ ABS/ + Schaltgetriebe 3)																						
1.6 i.e.	57	01.88	04.93	+ Automatikgetriebe 4)																						
1.6 i.e.	66	01.88	12.91																							
1.7 D		01.88	04.93	+ ABS																						
1.8 i.e.		03.90	04.93																							
1.9 D		01.88	04.93	+ ABS																						
1.9 TD		01.88	04.93																							
	1.1		01.88	04.93	- ABS	13.0460-2948.2	602948				21100 16,7 +/WK/S LUC															
	1.4		01.88	04.93	- ABS																					
	1.4 i.e.		01.88	04.93	- ABS																					
	1.6		01.88	04.93	- ABS/ + Schaltgetriebe 1)																					
	1.6 i.e.	57	01.88	04.93	- ABS/ + Schaltgetriebe 1)																					
	1.7 D		01.88	04.93	- ABS																					
	1.9 D		01.88	04.93	- ABS																					
	1.1		01.88	04.93	+ ABS							13.0460-2949.2	602949				20833 17,0 +/WK/S LUC									
	1.4		01.88	04.93	+ ABS																					
	1.4 i.e.		01.88	04.93	+ ABS																					
	1.6		01.88	04.93	+ ABS/ + Schaltgetriebe 3)																					
1.6		01.88	04.93	+ Automatikgetriebe 4)																						
1.6 i.e.	57	01.88	04.93	+ ABS/ + Schaltgetriebe 3)																						
1.6 i.e.	57	01.88	04.93	+ Automatikgetriebe 4)																						
1.6 i.e.	66	01.88	12.91																							
1.7 D		01.88	04.93	+ ABS																						
1.8 i.e.		03.90	04.93																							

1) - ABS/ + manual transmission / - ABS/ + scatola camb.velocità / - ABS/ + transmission mécanique / - ABS/ + cambio de velocidad
 2) - ABS/ + autom.transmission / - ABS/ + scatola cambio autom. / - ABS/ + transmission automatique / - ABS/ + cambio automático
 3) + ABS/ + manual transm. / + ABS/+ scatola camb.velocità / + ABS/ + transmission mécanique / + ABS/ + cambio de velocidad
 4) + autom.transmission / + scatola cambio automatico / + transmission automatique / + cambio automático

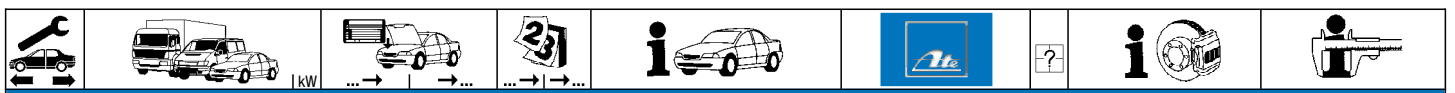

FIAT TIPO (88-93)										
	1.8 i.e. 16V 1.9 D 1.9 TD 2.0 i.e. 2.0 i.e. 16V	101 80 107		10.89 01.88 01.88 09.90 01.91	04.93 04.93 + ABS 04.93 04.93 04.93	13.0460-2949.2 602949 13.0460-2979.2 602979			20833 17,0 +WK/S 21147 19,0 +WK/S	LUC LUC
	1.1 1.4 1.4 i.e. 1.6 1.6 i.e. 1.7 D 1.9 D	57 57 57 66		01.88 01.88 01.88 01.88 01.88 01.88 01.88	04.93 - ABS 04.93 - ABS 04.93 - ABS 04.93 - ABS/ + Schaltgetriebe 1) 04.93 - ABS/ + Schaltgetriebe 1) 04.93 - ABS 04.93 - ABS	24.0111-0119.1 411119 24.0112-0127.1 412127			241 11,0 9,2 +B 258 12,0 10,2 +B	
	1.1 1.4 1.4 i.e. 1.6 1.6 i.e. 1.6 i.e. 1.7 D 1.8 i.e. 1.9 D 1.9 TD	57 57 66 		01.88 01.88 01.88 01.88 01.88 01.88 01.88 03.90 01.88 01.88	04.93 + ABS 04.93 + ABS 04.93 + ABS 04.93 + ABS/ + Schaltgetriebe 2) 04.93 + Automatikgetriebe 3) 04.93 + ABS/ + Schaltgetriebe 2) 04.93 + Automatikgetriebe 3) 12.91 04.93 + ABS 04.93 04.93 + ABS	24.0120-0142.1 420142 24.0320-0142.1 520142 24.0122-0107.1 422107			258 20,0 18,2 V L +B 258 20,0 18,2 V L +B PD 284 22,0 20,2 V +B	
	1.1 1.4 1.4 i.e. 1.6 1.6 i.e. 1.9 D 1.9 TD			01.88 01.88 01.88 01.88 01.88 01.88	04.93 04.93 04.93 04.93 04.93 04.93	24.5112-0360.3 330513 24.5112-0384.3 330651	2 2		L=360 L=387	
	1.1 1.4 1.4 i.e. 1.6 1.6 i.e. 1.7 D 1.8 i.e. 1.8 i.e. 16V 1.9 D 1.9 TD 2.0 i.e. 2.0 i.e. 16V	101 101 		01.88 01.88 01.88 01.88 01.88 01.88 03.90 10.89 01.88 01.88 09.90 01.91	04.93 + ABS 04.93 + ABS 04.93 + ABS 04.93 + ABS 04.93 + ABS 04.93 + ABS 04.93 + ABS 04.93 04.93 + ABS 04.93 + ABS 04.93 04.93	24.3344-1703.5 240117 24.3344-1704.5 240118 24.0101-3601.2 260044	 		D=34, - Halter D=34, - Halter Bremsattel-Zubehör	LUC LUC LUC
	1.1 1.4 1.4 i.e. 1.6 1.6 i.e. 1.7 D 1.8 i.e. 1.8 i.e. 16V 1.9 D 1.9 TD 2.0 i.e. 2.0 i.e. 16V	101 101 		01.88 01.88 01.88 01.88 01.88 01.88 03.90 10.89 01.88 01.88 09.90 01.91	04.93 + ABS 04.93 + ABS 04.93 + ABS 04.93 + ABS 04.93 + ABS 04.93 + ABS 04.93 + ABS 04.93 04.93 + ABS 04.93 + ABS 04.93 04.93	13.0460-2951.2 602951 13.0460-0072.2 610072			21103 14,2 /S Belagsatz-Zubehör	LUC LUC
	1.1 1.4 1.4 i.e. 1.6 1.6 i.e. 1.7 D 1.8 i.e. 1.8 i.e. 16V 1.9 D 1.9 TD 2.0 i.e. 2.0 i.e. 16V	101 101 		01.88 01.88 01.88 01.88 01.88 01.88 03.90 10.89 01.88 01.88 09.90 01.91	04.93 + ABS 04.93 + ABS 04.93 + ABS 04.93 + ABS 04.93 + ABS 04.93 + ABS 04.93 + ABS 04.93 04.93 + ABS 04.93 + ABS 04.93 04.93	24.0111-0119.1 411119			241 11,0 9,2 +B	
	1.1 1.4 1.4 i.e. 1.6 1.6 i.e.			01.88 01.88 01.88 01.88 01.88	04.93 04.93 04.93 04.93 04.93	24.5228-0223.3 330530	2		L=223	
	1.1 1.4 1.4 i.e. 1.6 1.6 i.e.	57 57		01.88 01.88 01.88 01.88 01.88	04.93 - ABS 04.93 - ABS/ + Schaltgetriebe 1) 04.93 - ABS/ + Schaltgetriebe 1) 04.93 - ABS/ + Schaltgetriebe 1) 04.93 - ABS/ + Schaltgetriebe 1)	24.3215-1102.3 020156			Rz 15,87	BDX
	1.4 1.4 i.e. 1.7 D 1.9 D			01.88 01.88 01.88 01.88	04.93 - ABS/ + Automatikgetriebe 4) 04.93 - ABS/ + Automatikgetriebe 4) 04.93 - ABS 04.93 - ABS	24.3219-1102.3 020190			Rz 19,05	BDX

1) - ABS/ + manual transmission / - ABS/+ scatola camb.velocità / - ABS/ + transmission mécanique / - ABS/ + cambio de velocidad
2) + ABS/ + manual transm. / + ABS/+ scatola camb.velocità / + ABS/ + transmission mécanique / + ABS/ + cambio de velocidad
3) + autom.transmission / + scatola cambio automatico / + transmission automatique / + cambio automático
4) - ABS/ + autom.transmission / - ABS/ + scatola cambio autom. / - ABS/ + transmission automatique / - ABS/ + cambio automático



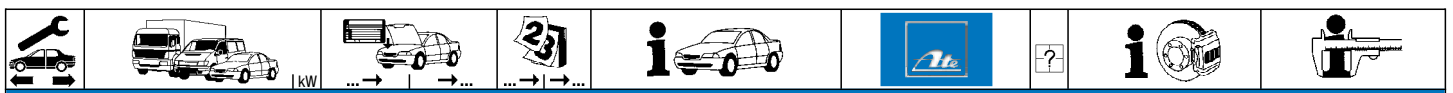

FIAT TIPO (88-93)



















	1.1			01.88	04.93	- ABS	03.0137-0207.2	650207		180 x 32 Bremsbacken-Zubehör	BDX
	1.4			01.88	04.93	- ABS	03.0137-9088.2	669088			
	1.4 i.e.			01.88	04.93	- ABS					
	1.6			01.88	04.93	- ABS/ + Schaltgetriebe ¹⁾					
	1.6 i.e.	57		01.88	04.93	- ABS/ + Schaltgetriebe ¹⁾					
	1.7 D			01.88	04.93	- ABS					
	1.9 D			01.88	04.93	- ABS					
	1.6			01.88	04.93	- ABS/ + Automatikgetriebe ²⁾	03.0137-0208.2	650208			
	1.6 i.e.	57		01.88	04.93	- ABS/ + Automatikgetriebe ²⁾	03.0137-9081.2	669081			
	1.6 i.e.	66		01.88	12.91	- ABS					
1.8 i.e.			03.90	04.93	- ABS						
1.9 TD			01.88	04.93	- ABS						
	1.1			01.88	04.93	- ABS	24.0218-0011.1	480006		180/181,4 x 40	
	1.4			01.88	04.93	- ABS					
	1.4 i.e.			01.88	04.93	- ABS					
	1.6			01.88	04.93	- ABS/ + Schaltgetriebe ¹⁾					
	1.6 i.e.	57		01.88	04.93	- ABS/ + Schaltgetriebe ¹⁾					
	1.7 D			01.88	04.93	- ABS					
	1.9 D			01.88	04.93	- ABS					
	1.6			01.88	04.93	- ABS/ + Automatikgetriebe ²⁾	24.0222-8018.1	480078			
	1.6 i.e.	57		01.88	04.93	- ABS/ + Automatikgetriebe ²⁾					
	1.6 i.e.	66		01.88	12.91	- ABS					
1.8 i.e.			03.90	04.93	- ABS						
1.9 TD			01.88	04.93	- ABS						
	1.4			01.88	04.93	- ABS/ + Automatikgetriebe ²⁾	03.0520-1219.3	691219		19,05/180x32 TopKit	BDX
	1.4 i.e.			01.88	04.93	- ABS/ + Automatikgetriebe ²⁾					
	1.7 D			01.88	04.93	- ABS					
	1.9 D			01.88	04.93	- ABS					
	1.1			01.88	04.93	- ABS	24.3727-0511.2	580511	<input type="checkbox"/>		
	1.4			01.88	04.93	- ABS	24.3727-0510.2	580510	<input type="checkbox"/>		
	1.4 i.e.			01.88	04.93	- ABS					
	1.6			01.88	04.93	- ABS/ + Schaltgetriebe ¹⁾					
	1.6 i.e.	57		01.88	04.93	- ABS/ + Schaltgetriebe ¹⁾					
	1.7 D			01.88	04.93	- ABS					
1.9 D			01.88	04.93	- ABS						
1.6			01.88	04.93	- ABS/ + Automatikgetriebe ²⁾	24.3727-0513.2	580513	<input type="checkbox"/>			
1.6 i.e.	57		01.88	04.93	- ABS/ + Automatikgetriebe ²⁾						
1.6 i.e.	66		01.88	12.91	- ABS						
1.8 i.e.			03.90	04.93	- ABS						
1.9 TD			01.88	04.93	- ABS						
1.1			01.88	04.93	+ ABS	24.3727-0521.2	580521	<input type="checkbox"/>			
1.4			01.88	04.93	+ ABS	24.3727-0006.2	580006	<input type="checkbox"/>			
1.4 i.e.			01.88	04.93	+ ABS						
1.6			01.88	04.93	+ ABS						
1.6 i.e.	57		01.88	04.93	+ ABS						
1.6 i.e.	66		01.88	12.91	+ ABS						
1.7 D			01.88	04.93	+ ABS						
1.8 i.e.			03.90	04.93	+ ABS						
1.8 i.e. 16V	101		10.89	04.93							
1.9 D			01.88	04.93	+ ABS						
1.9 TD			01.88	04.93	+ ABS						
2.0 i.e.	80		09.90	04.93							
2.0 i.e. 16V	107		01.91	04.93							
	1.1			01.88	04.93		24.3728-0503.2	590503		L=729	
	1.4			01.88	04.93						
	1.4 i.e.			01.88	04.93						
	1.6			01.88	04.93						
	1.6 i.e.			01.88	04.93						
	1.7 D			01.88	04.93						
	1.9 TD			01.88							
	1.8 i.e.			03.90	04.93		24.3728-0502.2	590502			
	1.8 i.e. 16V	101		10.89	04.93						
	1.9 D			01.88	04.93						
1.9 TD		2067625		04.93							
2.0 i.e.			09.90	04.93							
2.0 i.e. 16V			01.91	04.93							

FIAT TIPO (93-95)

	1.4 i.e.			05.93	09.95	+ ABS	24.3541-1748.5	240222	<input type="checkbox"/>	D=54, - Halter	LUC
	1.6 i.e.			05.93	09.95	+ ABS					
	1.8 i.e.			05.93	09.95						
	1.9 TD			05.93	09.95						
	1.4 i.e.			05.93	09.95		13.0460-2949.2	602949		20833 17,0 +/WK/S	LUC
	1.6 i.e.			05.93	09.95						
	1.7 D			05.93	09.95						
	1.8 i.e.			05.93	09.95						
	1.9 D			05.93	09.95						
	1.9 TD			05.93	09.95						
	2.0 i.e.	83		05.93	09.95						
2.0 i.e. 16V			05.93	09.95		13.0460-2979.2	602979		21147 19,0 +/WK/S	LUC	
	1.4 i.e.			05.93	09.95	- ABS	24.0111-0119.1	411119		241 11,0 9,2 +B	
	1.6 i.e.			05.93	09.95	- ABS					
	1.7 D			05.93	09.95						
	1.9 D			05.93	09.95						
	1.4 i.e.			05.93	09.95	+ ABS	24.0112-0127.1	412127		258 12,0 10,2 +B	

¹⁾ - ABS/ + manual transmission / - ABS/ + scatola camb.velocità / - ABS/ + transmission mécanique / - ABS/ + cambio de velocidad

²⁾ - ABS/ + autom.transmission / - ABS/ + scatola cambio autom. / - ABS/ + transmission automatique / - ABS/ + cambio automático

								
FIAT TIPO (93-95)								
	1.6 i.e. 1.8 i.e. 1.9 TD		05.93 05.93 05.93	09.95 + ABS 09.95 09.95	24.0112-0127.1	412127		258 12,0 10,2 +B
	2.0 i.e.	83	05.93	09.95	24.0120-0142.1 24.0320-0142.1	420142 520142		258 20,0 18,2 V L +B 258 20,0 18,2 V L +B PD
	2.0 i.e. 16V		05.93	09.95	24.0122-0107.1	422107		284 22,0 20,2 V +B
	1.4 i.e. 1.6 i.e. 1.7 D 1.8 i.e. 1.9 D 1.9 TD 2.0 i.e. 2.0 i.e. 16V	83	05.93 05.93 05.93 05.93 05.93 05.93 05.93 05.93	09.95 + ABS 09.95 + ABS 09.95 + ABS 09.95 + ABS 09.95 + ABS 09.95 + ABS 09.95 09.95	24.3344-1703.5 24.3344-1704.5 24.0101-3601.2	240117 240118 260044	<input type="checkbox"/> <input type="checkbox"/>	D=34, - Halter LUC D=34, - Halter LUC Bremssattel-Zubehör LUC
	1.4 i.e. 1.6 i.e. 1.7 D 1.8 i.e. 1.9 D 1.9 TD 2.0 i.e. 2.0 i.e. 16V	83	05.93 05.93 05.93 05.93 05.93 05.93 05.93 05.93	09.95 + ABS 09.95 + ABS 09.95 + ABS 09.95 + ABS 09.95 + ABS 09.95 + ABS 09.95 09.95	13.0460-2951.2 13.0460-0072.2	602951 610072		21103 14,2 /S LUC Belagsatz-Zubehör LUC
	1.4 i.e. 1.6 i.e. 1.7 D 1.8 i.e. 1.9 D 1.9 TD 2.0 i.e. 2.0 i.e. 16V	83	05.93 05.93 05.93 05.93 05.93 05.93 05.93 05.93	09.95 + ABS 09.95 + ABS 09.95 + ABS 09.95 + ABS 09.95 + ABS 09.95 + ABS 09.95 09.95	24.0111-0119.1	411119		241 11,0 9,2 +B
	1.4 i.e. 1.6 i.e. 1.7 D 1.8 i.e. 1.9 D 1.9 TD 2.0 i.e. 2.0 i.e. 16V	83	05.93 05.93 05.93 05.93 05.93 05.93 05.93 05.93	09.95 09.95 09.95 09.95 09.95 09.95 09.95 09.95	83.6401-0159.3	330746	2	L=160
	1.4 i.e. 1.6 i.e. 1.7 D 1.9 D		05.93 05.93 05.93 05.93	09.95 - ABS 09.95 - ABS/ + Schaltgetriebe ¹⁾ 09.95 - ABS 09.95 - ABS	24.3222-1701.3	020376		Rz 22,20
	1.6 i.e. 1.8 i.e. 1.9 TD		05.93 05.93 05.93	09.95 - ABS/ + Automatikgetriebe ²⁾ 09.95 - ABS 09.95 - ABS	24.3220-1116.3	020313		Rz 20,64
	1.4 i.e. 1.6 i.e. 1.7 D 1.9 D		05.93 05.93 05.93 05.93	09.95 - ABS 09.95 - ABS/ + Schaltgetriebe ¹⁾ 09.95 - ABS 09.95 - ABS	03.0137-0207.2 03.0137-9088.2	650207 669088		180 x 32 BDX Bremsbacken-Zubehör BDX
	1.6 i.e. 1.8 i.e. 1.9 TD		05.93 05.93 05.93	09.95 - ABS/ + Automatikgetriebe ²⁾ 09.95 - ABS 09.95 - ABS	03.0137-0208.2 03.0137-9081.2	650208 669081		228 x 42 HEB Bremsbacken-Zubehör
	1.4 i.e. 1.6 i.e. 1.7 D 1.9 D		05.93 05.93 05.93 05.93	09.95 - ABS 09.95 - ABS/ + Schaltgetriebe ¹⁾ 09.95 - ABS 09.95 - ABS	24.0218-0011.1	480006		180/181,4 x 40
	1.6 i.e. 1.8 i.e. 1.9 TD		05.93 05.93 05.93	09.95 - ABS/ + Automatikgetriebe ²⁾ 09.95 - ABS 09.95 - ABS	24.0222-8018.1	480078		228/230 x 48
	1.4 i.e. 1.6 i.e. 1.7 D 1.9 D		05.93 05.93 05.93 05.93	09.95 - ABS 09.95 - ABS/ + Schaltgetriebe ¹⁾ 09.95 - ABS 09.95 - ABS	03.0420-4322.3	684322		22,20/180x32 Kit BDX
	1.6 i.e. 1.8 i.e. 1.9 TD		05.93 05.93 05.93	09.95 - ABS/ + Automatikgetriebe ²⁾ 09.95 - ABS 09.95 - ABS	03.0420-4520.3	684520		20,64/228x42 Kit
	1.4 i.e. 1.6 i.e. 1.7 D 1.9 D		05.93 05.93 05.93 05.93	09.95 - ABS 09.95 - ABS/ + Schaltgetriebe ¹⁾ 09.95 - ABS 09.95 - ABS	24.3727-0511.2 24.3727-0510.2	580511 580510	<input type="checkbox"/> <input type="checkbox"/>	L=1415 L=1375
	1.6 i.e. 1.8 i.e. 1.9 TD		05.93 05.93 05.93	09.95 - ABS/ + Automatikgetriebe ²⁾ 09.95 - ABS 09.95 - ABS	24.3727-0513.2	580513	<input type="checkbox"/>	L=1445
	1.4 i.e. 1.6 i.e. 1.7 D 1.8 i.e. 1.9 D 1.9 TD 2.0 i.e. 2.0 i.e. 16V	83	05.93 05.93 05.93 05.93 05.93 05.93 05.93 05.93	09.95 + ABS 09.95 + ABS 09.95 + ABS 09.95 + ABS 09.95 + ABS 09.95 + ABS 09.95 09.95	24.3727-0521.2 24.3727-0006.2	580521 580006	<input type="checkbox"/> <input type="checkbox"/>	L=1517 L=1460

¹⁾ - ABS/ + manual transmission / - ABS/+ scatola camb.velocità / - ABS/ + transmission mécanique / - ABS/ + cambio de velocidad

²⁾ - ABS/ + autom.transmission / - ABS/+ scatola cambio autom. / - ABS/ + transmission automatique / - ABS/ + cambio automático

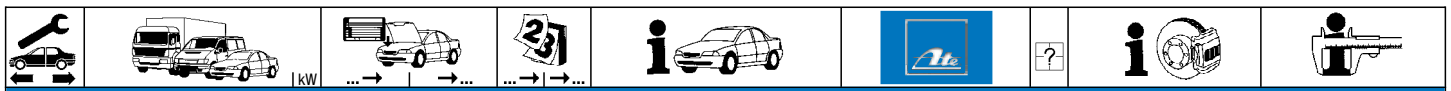





















FIAT TIPO (93-95)





















	1.4 i.e.		05.93	09.95	24.3728-0503.2	590503		L=729
	1.6 i.e.		05.93	09.95				
	1.7 D		05.93	09.95				
	1.8 i.e.		05.93	09.95	24.3728-0502.2	590502		L=764
	1.9 D		05.93	09.95				
	1.9 TD		05.93	09.95				
2.0 i.e.	83	05.93	09.95					
2.0 i.e. 16V		05.93	09.95					

FIAT UNO (83-89)





























	45		03.83	12.85	24.2119-0826.3	010349		THz 19,05				
	45		01.86	09.89					24.2120-0801.3	010362	THz 20,64	
	1.3 D	0038672	03.83		24.2119-0827.3	010350		THz 19,05				
	1.7 D	0038672	02.84									
	55	2125560	03.83									
	55	1570528	03.83									
	60	2125560	03.83									
	60	1570528	03.83									
	70	2125560	03.83									
	70	1570528	03.83									
	1.3 D	0038673		12.85					24.2119-0826.3	010349		THz 19,05
	1.7 D	0038673		12.85								
55	1570529		12.85									
55	2125561		12.85									
60	1570529		12.85									
60	2125561		12.85									
70	1570529		12.85									
70	2125561		12.85									
	1.3 D		01.86	09.89	24.2120-0801.3	010362		THz 20,64				
	1.7 D		01.86	09.89								
	1.7 TD		05.86	09.89 + ①								
	55		01.86	09.89								
	60		01.86	09.89								
	70		01.86	09.89								
	70		01.86	09.89								
	1.3 D		03.83	09.89	13.0460-3939.2	603939		20775 18,0 /WE BDX				
	1.7 D		02.84	09.89								
	45		03.83	09.89								
	55		03.83	09.89								
	60		03.83	09.89								
	70		03.83	09.89								
	75		10.85	09.89								
1.3 i.e. Turbo		05.85	09.89	13.0460-2941.2	602941		20839 17,0 /WK/S LUC					
1.7 TD		05.86	09.89 + ①									
	1.3 D		03.83	09.89	24.0111-0130.1	411130		227 10,8 9,0 +B				
	1.7 D		02.84	09.89								
	45		03.83	09.89								
	55		03.83	09.89								
	60		03.83	09.89								
	70		03.83	09.89								
	75		10.85	09.89								
	1.7 TD		05.86	09.89 + ①					24.0112-0122.1	412122		240 12,0 10,8
	75		10.85	09.89								
	1.3 i.e. Turbo		05.85	09.89					24.0120-0143.1	420143		240 20,0 18,2 V
	45		03.83	09.89	24.5112-0410.3	330494	2	L=410				
	55		03.83	09.89								
	1.3 i.e. Turbo		05.85	09.89	24.0111-0130.1	411130		227 10,8 9,0 +B				
	1.3 D		03.83	09.89	24.5228-0200.3	330470	2	L=200				
	1.7 D		02.84	09.89								
	1.7 TD		05.86	09.89 + ①								
	45		03.83	09.89								
	55		03.83	09.89								
	60		03.83	09.89								
	75		10.85	09.89								
	1.3 D		03.83	09.89	24.3219-0803.3	020183		Rz 19,05				
	1.7 D		02.84	09.89								
	1.7 TD		05.86	09.89 + ①								
	45		03.83	09.89								
	55		03.83	09.89								
	60		03.83	09.89								
	75		10.85	09.89								
	1.3 D		03.83	09.89	03.0137-0015.2	650015		185 x 31 AUT FI				
	1.7 D		02.84	09.89								
	1.7 TD		05.86	09.89 + ①								
	45		03.83	09.89								
	55		03.83	09.89								
	60		03.83	09.89								
	75		10.85	09.89								



        						
FIAT UNO (83-89)						
	1.3 D 1.7 D 1.7 TD 45 55 60 70 75	03.83 09.89 02.84 09.89 05.86 09.89 + ① 03.83 09.89 03.83 09.89 03.83 09.89 03.83 09.89 10.85 09.89	24.0218-5001.1	480012		185/186,8 x 37
	1.3 D 1.7 D 1.7 TD 45 55 60 70 75	03.83 09.89 02.84 09.89 05.86 09.89 + ① 03.83 09.89 03.83 09.89 03.83 09.89 03.83 09.89 10.85 09.89	03.0420-0319.3	680319		19,05/185x31 Kit FI
	1.3 D 1.7 D 1.7 TD 45 55 60 70 75	03.83 09.89 02.84 09.89 05.86 09.89 + ① 03.83 09.89 03.83 09.89 03.83 09.89 03.83 09.89 10.85 09.89	24.3727-0507.2	580507	<input type="checkbox"/>	L=521
			24.3727-0508.2	580508	<input type="checkbox"/>	L=2018
	1.3 D 1.3 i.e. Turbo 1.7 D 1.7 TD 45 55 60 70 75	03.83 09.89 05.85 09.89 02.84 09.89 05.86 09.89 + ① 03.83 09.89 03.83 09.89 03.83 09.89 03.83 09.89 10.85 09.89	24.6513-0801.3	320117		BRL 1/3 (2)
	1.3 D 1.7 D 1.7 TD 45 55 60 70 75	03.83 09.89 02.84 09.89 05.86 09.89 + ① 03.83 09.89 03.83 09.89 03.83 09.89 03.83 09.89 10.85 09.89	24.3728-0501.2	590501		L=625
FIAT UNO (90-06)						
	0.9 1.0 i.e. 1.1 i.e. 1.4 i.e. 1.4 TD 1.5 i.e. 1.6 1.7 D 1.9 TD	10.89 06.95 10.89 06.95 10.89 06.95 10.89 06.95 10.89 06.95 10.89 06.95 12.89 06.95 10.89 06.95 10.89 06.95 + ①	24.2120-0801.3	010362		Thz 20,64
	1.4 TD 1.5 i.e. 1.9 TD	10.89 06.95 10.89 06.95 10.89 06.95 + ①	24.3481-1703.5	240051	<input type="checkbox"/>	D=48, - Halter LUC
			24.3481-1704.5	240052	<input type="checkbox"/>	D=48, - Halter LUC
	0.9 1.0 i.e. 1.1 i.e. 1.4 i.e. 1.5 i.e. 1.6 1.7 D 1.3 i.e. Turbo 1.4 i.e. Turbo 1.4 TD 1.5 i.e. 1.9 TD	10.89 06.95 10.89 06.95 10.89 06.95 10.89 06.95 10.89 06.95 12.89 06.95 10.89 06.95 10.89 03.92 10.89 06.95 10.89 06.95 10.89 06.95 10.89 06.95 + ①	13.0460-3940.2	603940		20775 18,0 /WK BDX
			13.0460-3939.2	603939		20775 18,0 /WE BDX
			13.0460-0410.2	610410		Belagsatz-Zubehör BDX
			13.0460-2941.2	602941		20839 17,0 /WK/S LUC
	0.9 1.0 i.e. 1.1 i.e. 1.4 i.e. 1.5 i.e. 1.6 1.7 D 1.4 TD 1.5 i.e. 1.9 TD 1.3 i.e. Turbo 1.4 i.e. Turbo	10.89 06.95 10.89 06.95 10.89 06.95 10.89 06.95 10.89 06.95 12.89 06.95 10.89 06.95 10.89 06.95 10.89 06.95 10.89 06.95 + ① 10.89 03.92 10.89 06.95	24.0111-0130.1	411130		227 10,8 9,0 +B
			24.0112-0122.1	412122		240 12,0 10,8
			24.0120-0143.1	420143		240 20,0 18,2 V
	0.9 1.0 i.e. 1.1 i.e. 1.4 i.e. 1.4 TD 1.5 i.e.	10.89 06.95 10.89 06.95 10.89 06.95 10.89 06.95 10.89 06.95 10.89 06.95	24.5112-0390.3	330517	2	L=390, + Clip
			24.5112-0386.3	330516	2	L=385
						

        											
FIAT UNO (90-06)											
	1.6 1.7 D 1.9 TD			12.89 10.89 10.89	06.95 06.95 06.95 + ①	24.5112-0386.3	330516	2		L=385	
	1.3 i.e. Turbo 1.4 i.e. Turbo			10.89 10.89	03.92 06.95	24.0111-0130.1	411130			227 10,8 9,0 +B	
	0.9 1.0 i.e. 1.1 i.e. 1.4 i.e. 1.4 TD 1.5 i.e. 1.7 D 1.9 TD			10.89 10.89 10.89 10.89 10.89 10.89 10.89	06.95 06.95 06.95 06.95 06.95 06.95 06.95 + ①	24.5228-0200.3	330470	2		L=200	
	0.9 1.0 i.e. 1.1 i.e. 1.4 i.e. 1.4 TD 1.5 i.e. 1.7 D 1.9 TD			10.89 10.89 10.89 10.89 10.89 10.89 10.89	06.95 06.95 06.95 06.95 06.95 06.95 06.95 + ①	24.3219-0803.3	020183			Rz 19,05	
	0.9 1.0 i.e. 1.1 i.e. 1.4 i.e. 1.4 TD 1.5 i.e. 1.7 D 1.9 TD			10.89 10.89 10.89 10.89 10.89 10.89 10.89	06.95 06.95 06.95 06.95 06.95 06.95 06.95 + ①	03.0137-0015.2 03.0137-0273.2 03.0137-9021.2	650015 650273 669021			185 x 31 AUT 185 x 31 AUT Bremsbacken-Zubehör	FI AP FI
	0.9 1.0 i.e. 1.1 i.e. 1.4 i.e. 1.4 TD 1.5 i.e. 1.7 D 1.9 TD			10.89 10.89 10.89 10.89 10.89 10.89 10.89	06.95 06.95 06.95 06.95 06.95 06.95 06.95 + ①	24.0218-5001.1	480012			185/186,8 x 37	
	0.9 1.0 i.e. 1.1 i.e. 1.4 i.e. 1.4 TD 1.5 i.e. 1.7 D 1.9 TD			10.89 10.89 10.89 10.89 10.89 10.89 10.89	06.95 06.95 06.95 06.95 06.95 06.95 06.95 + ①	03.0420-0319.3 03.0520-4319.3	680319 694319			19,05/185x31 Kit 19,05/185x31 TopKit	FI AP
	0.9 1.0 i.e. 1.1 i.e. 1.4 i.e. 1.4 TD 1.5 i.e. 1.7 D 1.9 TD		7767870 7767870 7767870 7767870 7767870 7767870 7767870	10.89 10.89 10.89 10.89 10.89 10.89 10.89		24.3727-0507.2 24.3727-0508.2	580507 580508	<input type="checkbox"/> <input type="checkbox"/>		L=521 L=2018	
	0.9 1.0 i.e. 1.1 i.e. 1.4 i.e. 1.4 TD 1.5 i.e. 1.7 D 1.9 TD	7767871 7767871 7767871 7767871 7767871 7767871 7767871			06.95 06.95 06.95 06.95 06.95 06.95 06.95 + ①	24.3727-0509.2 24.3727-0518.2	580509 580518	<input type="checkbox"/> <input type="checkbox"/>		L=523 L=2016	
	0.9 1.0 i.e. 1.1 i.e. 1.3 i.e. Turbo 1.4 i.e. 1.4 i.e. Turbo 1.4 TD 1.5 i.e. 1.7 D 1.9 TD			10.89 10.89 10.89 10.89 10.89 10.89 10.89 10.89 10.89	06.95 06.95 06.95 03.92 06.95 06.95 06.95 06.95 06.95 + ①	24.6513-0801.3	320117			BRL 1/3 (2)	
FIAT X 1/9 (72-89)											
	1.3 1.5			10.72 11.78	12.79 09.82	13.0460-3936.2	603936			20073 17,3	BDX
	1.3 1.5			10.72 11.78	12.79 12.89	24.0111-0130.1	411130			227 10,8 9,0 +B	
	1.3 1.5			10.72 11.78	12.79 12.89	24.5209-0280.3	330044	2		L=280	















								
FIAT X 1/9 (72-89)								
	1.3 1.5		10.72 11.78	12.79 12.89	24.0111-0130.1	411130		227 10,8 9,0 +B
FORD A-Serie (73-83)								
	alle Typen		04.73	07.83	83.7704-0320.3	330851	1 <input type="checkbox"/>	L=320
FORD 12M/15M (62-70)								
	12M (P4) 12M (P6) 15M (P6)		01.62 01.66 01.66	12.66 12.70 12.70	13.0441-4819.2	250104		Dichtungssatz ATE
	12M (P4) 12M (P6) 15M (P6)		01.62 01.66 01.66	12.66 12.70 12.70	13.0460-4035.2	604035		20173 15,0 ATE
FORD 17M/20M/26M (60-71)								
	17M / 20M (P5)		01.64	12.67	13.0441-4819.2	250104		Dichtungssatz ATE
	17M / 20M (P5)		01.64	12.67	- 2,3/ - 2,6/ - RS	13.0460-4035.2	604035	20173 15,0 ATE
	17M / 20M (P5) 26M (P7)		01.64 01.69	12.67 12.71	+ 2,3/ + 2,6/ + RS	13.0460-6027.2	606027	20011 15,0 ATE
	17M / 20M (P5)		01.64	12.71	03.3217-0602.3	020024		Rz 17,46
FORD CAPRI (68-74)								
	1600 1700 2000 2300 2600 2600 RS 3000	55 92 110	08.72 12.68 02.69 02.69 08.70 08.70 01.70	02.74 02.74 02.74 02.74 02.74 02.74 02.74	13.0441-5409.2	250112		Dichtungssatz ATE
	1600 1700 2000 2300 2600 2600 RS 3000	55 92 110	08.72 12.68 02.69 02.69 08.70 08.70 01.70	02.74 02.74 02.74 02.74 02.74 02.74 02.74	13.0460-7042.2 13.0460-0126.2	607042 610126		20491 15,0 LUC Belagsatz-Zubehör LUC
	1600 1700 2000 2300 2600 2600 RS 3000	55 92 110	08.72 12.68 02.69 02.69 08.70 08.70 01.70	02.74 02.74 02.74 02.74 02.74 02.74 02.74	24.0113-0118.1	413118		245 12,7 11,4
FORD CAPRI (74-86)								
	alle Typen		02.74	06.85	+ Bremsgerät/ - 2,8 i ¹⁾	03.2120-0148.3	010070	THz 20,64 + Behälter ATE
	1.3 3.0 alle Typen		01.75 02.78 02.74	12.82 12.86 12.86	- 2,8 i	13.0441-5409.2	250112	Dichtungssatz ATE
	2.8 i		02.81	12.86		13.0441-5409.2	250112	Dichtungssatz ATE
	1.3 3.0 alle Typen		01.75 02.78 02.74	12.82 12.86 12.86	- 2,8 i	13.0460-7042.2 13.0460-0126.2	607042 610126	20491 15,0 LUC Belagsatz-Zubehör LUC
	1.3 alle Typen		01.75 02.74	12.82 12.86	- 2,8 i ²⁾	24.0113-0118.1	413118	245 12,7 11,4
	1.3 1.3 alle Typen	40 44	01.78 11.74 11.74	12.82 12.82 12.86	- 2,8 i	24.3219-0903.3 24.3217-1706.3	020184 020044	8" Bremse ²⁾ 9" Bremse ³⁾ Rz 19,05 Rz 17,78
	2.8 i		02.81	12.86		24.3219-0903.3	020184	Rz 19,05
	1.3 2.8 i 3.0	40	02.74 02.81 02.78	12.82 12.82 09.81		24.0220-3001.2 24.0222-8010.2	480020 480027	203/204 x 45 229/229,4 x 64
FORD CONSUL / GRANADA (72-85)								
	1.7 Kombi 1.7 Lim. 2.0 Kombi 2.0 Lim. 2.0 Kombi 2.0 Lim. 2.1 D Lim. 2.3 Kombi 2.3 Lim. 2.5 D Kombi		02.72 02.72 02.72 02.72 08.81 08.81 08.81 08.81 08.81 08.82	05.73 05.73 05.73 05.73 06.85 06.85 12.83 06.85 06.85 06.85	03.2120-5503.3	010124	Anschlagschraube oben ⁴⁾	THz 20,64 + Behälter ATE THz 23,81 ATE

¹⁾ + booster unit/ - 2,8 i / + servofreno/ - 2,8 i / + servo-frein/ - 2,8 i / + servofreno/ - 2,8 i

²⁾ 8" brake / servofreno da 8" / frein de 8" / freno de 8"

³⁾ 9" brake / servofreno da 9" / frein de 9" / freno de 9"

⁴⁾ stop screw, top / vite di fermo in alto / vis de butée en haut / tornillo tope arriba

        								
FORD CONSUL / GRANADA (72-85)								
 2.5 D Lim. 2.8 i Kombi 2.8 i Lim. 2.8 Kombi 2.8 Lim.			08.82 06.85 08.81 06.85 08.81 06.85 08.81 06.85 08.81 06.85		03.2123-8611.3 010195		THz 23,81	ATE
 1.6 Lim. 1.7 Kombi 1.7 Lim. 1.9 D Lim. 2.0 Kombi 2.0 Lim. 2.0 Lim. 2.1 D Lim. 2.3 Kombi 2.3 Lim.	66 66		08.81 12.83 11.74 07.81 11.74 07.81 08.77 12.79 11.74 06.85 01.75 06.85 11.74 06.85 09.74 08.85 08.77 12.83 11.74 06.85 11.74 06.85		13.0441-5409.2 250112		Dichtungssatz	ATE
 1.6 Lim. 1.7 Kombi 1.7 Lim. 1.9 D Lim. 2.0 Kombi 2.0 Kombi 2.0 Lim. 2.0 Lim. 2.1 D Lim. 2.3 Kombi 2.3 Lim.	66 66		08.81 12.83 11.74 07.81 11.74 07.81 08.77 12.79 11.74 06.85 01.75 06.85 11.74 06.85 09.74 08.85 08.77 12.83 11.74 06.85 11.74 06.85		13.0460-7042.2 607042 13.0460-0126.2 610126		20491 15.0 Belagsatz-Zubehör	LUC LUC
 1.7 Lim. 1.9 D Lim. 2.0 Lim. 2.1 D Lim. 2.3 Kombi 2.3 Lim. 2.6 Kombi 2.6 Lim. 3.0 Kombi 3.0 Lim.			02.72 04.79 08.77 04.79 + DK N S FIN 08.77 04.79 + 4 Zylinder ¹⁾ 08.77 04.79 + DK N S FIN 08.77 04.79 + DK N S FIN 08.77 04.79 + DK N S FIN 08.77 04.79 + DK N S FIN 08.77 04.79 + DK N S FIN 08.77 04.79 + DK N S FIN 08.77 04.79 + DK N S FIN 08.77 04.79 + DK N S FIN		24.3220-1112.3 020223		Rz 20,64	
1.7 Kombi 1.9 D Lim. 2.0 Kombi 2.0 Lim. 2.1 D Lim. 2.3 Kombi 2.3 Lim. 2.6 Kombi 2.6 Lim. 2.8 i Kombi 2.8 i Lim. 2.8 Kombi 2.8 Lim. 3.0 Kombi 3.0 Lim.	66		02.72 04.79 - DK N S FIN 08.77 04.79 - DK N S FIN 02.72 04.79 - DK N S FIN 02.72 04.79 - DK N S FIN 08.77 04.79 - DK N S FIN 02.72 04.79 - DK N S FIN 02.72 07.77 02.72 07.77 08.77 04.79 - DK N S FIN 08.77 04.79 - DK N S FIN 08.77 04.79 - DK N S FIN 08.77 04.79 - DK N S FIN		24.3219-1107.3 020338	nur paarweise austauschen ²⁾	Rz 19,05	LUC
1.7 Kombi 1.7 Lim. 1.9 D Lim. 2.0 Kombi 2.0 Lim. 2.1 D Lim. 2.3 Kombi 2.3 Lim. 2.8 i Kombi 2.8 i Lim. 2.8 Kombi 2.8 Lim.	66		05.79 07.81 + DK FIN 05.79 07.81 + DK FIN 05.79 07.81 + DK FIN 05.79 07.81 + DK FIN 05.79 07.81 + DK FIN 05.79 07.81 + DK FIN 05.79 07.81 + DK FIN 05.79 07.81 + DK FIN 05.79 07.81 + DK FIN 05.79 07.81 + DK FIN		24.3219-1107.3 020338	nur paarweise austauschen ²⁾	Rz 19,05	LUC
1.7 Kombi 1.7 Lim. 1.9 D Lim. 2.0 Kombi 2.0 Lim. 2.1 D Lim. 2.3 Kombi 2.3 Lim. 2.8 i Kombi 2.8 i Lim. 2.8 Kombi 2.8 Lim.	66		05.79 07.81 - DK FIN 05.79 07.81 - DK FIN 05.79 07.81 - DK FIN 05.79 07.81 - DK FIN 05.79 07.81 - DK FIN 05.79 07.81 - DK FIN 05.79 07.81 - DK FIN 05.79 07.81 - DK FIN 05.79 07.81 - DK FIN 05.79 07.81 - DK FIN		24.3220-1112.3 020223		Rz 20,64	
1.6 Lim. 1.9 D Lim. 2.0 Kombi 2.0 Lim. 2.1 D Lim. 2.3 Kombi 2.3 Lim. 2.5 D Kombi 2.5 D Lim. 2.8 i Kombi			08.81 08.85 08.81 08.82 08.81 08.85 08.81 08.85 08.81 08.82 08.81 08.85 08.81 08.85 08.81 08.85 08.81 08.85 08.81 08.85		24.3222-1117.3 020272		Rz 22,20	

1) + 4 cylinder / + 4 cilindro / + 4 cylindre / + 4 cilindro
 2) to change only by pairs / sostituire solo a coppie / à changer seulement par paires / cambiar solamente por parejas



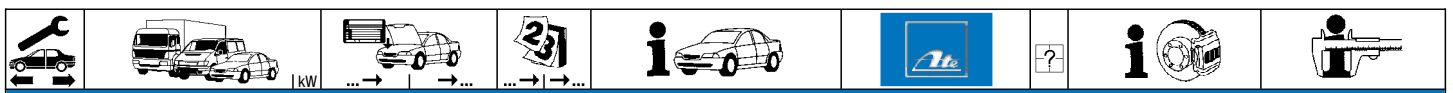

FORD CONSUL / GRANADA (72-85)										
	2.8 i Lim. 2.8 Kombi 2.8 Lim.			08.81 08.81 08.81	08.85 08.85 08.85		24.3222-1117.3	020272		Rz 22,20
	1.7 Lim. 1.9 D Lim. 2.0 Lim. 2.1 D Lim. 2.3 Lim. 2.5 Lim. 2.8 i Lim. 2.8 Lim. 3.0 Lim.			02.72 02.72 02.72 02.72 02.72 02.72 02.72 02.72 02.72	04.79 04.79 04.79 04.79 04.79 12.74 04.79 04.79 02.76		03.0137-9013.2	669013		Bremsbacken-Zubehör LUC Bremsbacken-Zubehör LUC
	1.7 Kombi 2.0 Kombi 2.3 Kombi 2.5 Kombi 2.8 i Kombi 2.8 Kombi 3.0 Kombi			02.72 02.72 02.72 02.72 02.72 02.72 02.72	04.79 04.79 04.79 02.76 04.79 04.79 02.76		03.0137-0036.2 03.0137-9013.2	650036 669013		254 x 57 Bremsbacken-Zubehör LUC

FORD ECONOVAN (85-92)										
	1.4 2.0 D			09.85 02.86	03.92 03.92		13.0460-5806.2	605806		20002 15,0 +/WK

FORD ESCORT (70-80)										
	alle Typen	◀		12.74	09.78	VA-Scheibenbremse/+ Bremsgerät ¹⁾	03.2119-0525.3	010046		THz 19,05 + Behälter ATE
	alle Typen	◀		10.78	07.80	+ Bremsgerät/ + Kent-Motor ²⁾	03.2119-0525.3	010046		THz 19,05 + Behälter ATE
	alle Typen	◀		10.78	07.80	+ Bremsgerät/ + Taunus-Motor ³⁾	03.2120-0148.3	010070		THz 20,64 + Behälter ATE
	RS 2000	◀		08.75	07.80		03.2120-0148.3	010070		THz 20,64 + Behälter ATE
	alle Typen			12.74	07.80		13.0441-5409.2	250112		Dichtungssatz ATE
	alle Typen			12.74	07.80		13.0460-7042.2 13.0460-0126.2	607042 610126		20491 15,0 Belagsatz-Zubehör LUC
	alle Typen			12.74	07.80	- RS 2000	24.0113-0122.1	413122		248 12,7 11,4
	RS 2000			03.75	07.80		24.0113-0118.1	413118		245 12,7 11,4
	alle Typen			12.74	04.76	VA-Trommelbremse ⁴⁾	24.3219-0903.3	020184		Rz 19,05
	1.3	51		12.74	11.75		24.3217-1706.3	020044		Rz 17,78
	1.6			12.74	07.80					
	1.3	51		12.75	07.80		24.3219-0903.3	020184		Rz 19,05
	RS 2000			03.75	07.80					
	1.0 Lim. 1.1 Lim. 1.3 Lim.			09.70 09.70 09.70	07.80 07.80 07.80		24.0220-3001.2	480020		203/204 x 45

FORD ESCORT / ORION (81-85)										
	alle Typen	◀		02.84	12.85	+ Bremsgerät/- Turbo/-Kastenw. ⁵⁾	24.2122-1712.3	010462		THz 22,20
	1.1 1.3 1.6 D			08.80 08.80 08.80	12.85 12.85 12.85		11.0441-5402.2 11.0101-5407.2 11.8171-0008.1	250028 260011 990049		Dichtungssatz ATE Hülssensatz ATE Führungsbolzen ATE
	1.6 XR3 XR3i			08.80 08.80 09.82	12.85 10.82 12.85		11.0441-5402.2 11.0101-5407.2 11.8171-0008.1	250028 260011 990049		Dichtungssatz ATE Hülssensatz ATE Führungsbolzen ATE
	1.6 RS Turbo			09.84	12.85		11.0441-6003.2 11.0101-5407.2 11.8171-0008.1 11.8116-0052.1	250037 260011 990049 390496	2	Dichtungssatz ATE Hülssensatz ATE Führungsbolzen ATE Haltefeder ATE
	alle Typen			08.80	12.85	- Turbo	13.0460-7071.2 13.0460-7027.2	607071 607027		20640 17,5 + 20783 17,5 +/WK ATE
	1.6 RS Turbo			09.84	12.85		13.0460-7040.2	607040		20907 18,0 + ATE
	1.1 1.3 1.6 D			08.80 08.80 08.80	12.85 12.85 12.85		24.0110-0193.1	410193		240 10,2 8,7
	1.6 XR3 XR3i			08.80 08.80 09.82	12.85 10.82 12.85	- Turbo	24.0124-0112.1	424112		240 24,2 22,2 V +B
	1.6 RS Turbo			09.84	12.85		24.0124-0113.1	424113		260 24,2 22,2 V
	alle Typen			05.83	12.85		24.5305-0370.3	331392	2	L=370
	alle Typen			02.82	12.85	- Kastenwagen ⁶⁾	83.6339-0253.3 83.6339-0228.3	330362 330361	<input type="checkbox"/> <input type="checkbox"/>	L=250 L=225
	alle Typen			08.80	02.83	- Kastenwagen/- XR3i ⁷⁾	24.3219-1107.3	020338		nur paarweise austauschen ⁸⁾ Rz 19,05 LUC
	alle Typen			03.83	12.85	- Kastenwagen ⁶⁾	24.3219-1107.3	020338		nur paarweise austauschen ⁸⁾ Rz 19,05 LUC
	XR3i			09.82	12.85					
	Kastenwagen			08.80	12.85		24.3222-1117.3	020272		Rz 22,20

1) FA disc brake/ + booster unit / A disco freno/ + servofreno / fr.à disque ess.AV/ + servofr. / ED disco de freno/ + servofreno
2) + booster unit/ + Kent engine / + servofreno/ + motore Kent / + servo-frein/ + moteur Kent / + servofreno/ + motor Kent
3) + booster unit/ + Taunus engine / + servofreno/ + motore Taunus / + servo-frein/ + moteur Taunus / + servofreno/ + motor Taunus
4) FA drum brake / A freno a tamburo / frein à tambour essieu AV / ED tambores de freno
5) + booster unit/- Turbo/- Van / + servofreno/ - Turbo/ - furgone / + servo-frein/ - Turbo/ - fourgonnette / + servofreno/ - Turbo/ - furgón
6) - Van / - furgone / - fourgonnette / - furgón
7) - Van/ - XR3i / - furgone/ - XR3i / - fourgonnette/ - XR3i / - furgón/ - XR3i
8) to change only by pairs / sostituire solo a coppie / à changer seulement par paires / cambiar solamente por parejas



FORD ESCORT / ORION (81-85)									
	alle Typen Kastenwagen XR3i	08.80 08.80 09.82	12.85 12.85 12.85	- Kastenwagen/ - XR3i/ - Turbo ¹⁾	03.0137-0138.2 03.0137-9043.2	650138 669043		180 x 32 HEB Bremsbacken-Zubehör	
	alle Typen Kastenwagen XR3i	08.80 08.80 09.82	12.85 12.85 12.85	- Kastenwagen/ - XR3i/ - Turbo ¹⁾	24.0218-0010.2 24.0220-3001.2	480005 480020	ohne Sensorring ²⁾	180/181,3 x 41,5 203/204 x 45	
	alle Typen	08.80	02.83	- Kastenwagen/ - XR3i ³⁾	03.0520-0219.3	690219		19,05/180x32 TopKit LUC	
	alle Typen	08.84	12.85	- Kastenwagen ⁴⁾	24.3727-0628.2	580628	1 ↑	L=151	
	alle Typen	08.80	12.85	- XR3i	24.3728-0615.2	590615		L=1210	
FORD ESCORT / ORION (86-90)									
	alle Typen	01.86	07.88	- SCS/ - Turbo	24.2122-1712.3	010462		THz 22,20	
	alle Typen	01.86	07.88	+ SCS/ - Turbo	24.2122-0906.3	010378		THz 22,20	
	1.1 1.3 1.6 D	01.86 01.86 01.86	08.90 08.90 03.89	- SCS	11.0441-5402.2 11.0101-5407.2 11.8171-0008.1	250028 260011 990049		Dichtungssatz Hülzensatz Führungsbolzen	ATE ATE ATE
	1.3 1.4 1.6 1.6 D 1.8 D XR3i	01.86 01.86 01.86 01.86 04.89 01.86	08.90 08.90 08.90 08.90 08.90 08.90	+ SCS + SCS	11.0441-5402.2 11.0101-5407.2 11.8171-0008.1	250028 260011 990049		Dichtungssatz Hülzensatz Führungsbolzen	ATE ATE ATE
	1.6 RS Turbo	01.86	08.90		11.0441-6003.2 11.0101-5407.2 11.8171-0008.1 11.8116-0052.1	250037 260011 990049 390496	2	Dichtungssatz Hülzensatz Führungsbolzen Haltefeder	ATE ATE ATE
	1.1 1.6 alle Typen XR3i	01.86 01.86 01.86 01.86	08.90 08.90 08.90 08.90	- Turbo	13.0460-7071.2	607071		20640 17,5 +	ATE
	1.6 RS Turbo	01.86	08.90		13.0460-7040.2	607040		20907 18,0 +	ATE
	1.1 1.3 1.6 D	01.86 01.86 01.86	08.90 08.90 03.89	- SCS	24.0110-0193.1	410193		240 10,2 8,7	
	1.3 1.4 1.6 1.6 D 1.8 D XR3i	01.86 01.86 01.86 01.86 04.89 01.86	08.90 08.90 08.90 08.90 08.90 08.90	+ SCS - Turbo + SCS	24.0124-0112.1	424112		240 24,2 22,2 V +B	
	1.6 RS Turbo	01.86	08.90		24.0124-0113.1	424113		260 24,2 22,2 V	
	alle Typen	01.86	08.90		24.5305-0370.3	331392	2	L=370	
	alle Typen	01.86	08.90	- Kastenwagen ⁴⁾	83.6339-0253.3 83.6339-0228.3	330362 330361		L=250 L=225	
	alle Typen Kastenwagen	01.86 01.86 01.86	08.90 08.90 08.90	- SCS/ - Turbo/ - Kastenwagen ⁵⁾	24.3219-1107.3	020338	nur paarweise austauschen ⁶⁾	Rz 19,05	LUC
	alle Typen Kastenwagen	01.86 01.86 01.86	08.90 08.90 08.90	+ SCS/ - Turbo	24.3222-1117.3	020272		Rz 22,20	
	alle Typen Kastenwagen	01.86 01.86 01.86	08.90 08.90 08.90	- SCS/ - Turbo/ - Kastenwagen ⁵⁾	03.0137-0138.2 03.0137-9043.2	650138 669043		180 x 32 HEB Bremsbacken-Zubehör	
	alle Typen Kastenwagen	01.86 01.86 01.86	08.90 08.90 08.90	+ SCS/ - Turbo	03.0137-9122.2	669122		Bremsbacken-Zubehör	
	alle Typen Kastenwagen	01.86 01.86 01.86	08.90 08.90 08.90	- SCS/ - Turbo/ - Kastenwagen ⁵⁾	24.0218-0010.2 24.0220-3001.2	480005 480020	ohne Sensorring ²⁾	180/181,3 x 41,5 203/204 x 45	
	alle Typen	01.86	08.90	- SCS/ - Turbo/ - Kastenwagen ⁵⁾	03.0520-0219.3	690219		19,05/180x32 TopKit LUC	
	1.1 alle Typen	01.86 01.86	08.90 08.90	- SCS/ - Kastenwagen/ - XR3i ⁷⁾	24.3727-0628.2 24.3727-0625.2	580628 580625	1 ↑ 1 ↓	L=151 L=2942	
	1.6 RS Turbo alle Typen XR3i	01.86 01.86 01.86	08.90 08.90 08.90	+ SCS/ - Kastenwagen ⁸⁾	24.3727-0628.2 24.3727-0622.2	580628 580622	1 ↑ 1 ↓	L=151 L=2965	
	1.1 1.1 1.3 1.3 1.4 1.4 1.6 1.6	01.86 02.87 01.86 02.87 01.86 02.87 01.86 02.87	04.86 08.90 04.86 08.90 04.86 08.90 04.86 08.90	mit geregelttem Katalysator ⁹⁾	24.3728-0615.2	590615		L=1210	

¹⁾ - Van/ - XR3i/ - Turbo / - furgone/ - XR3i/ - Turbo / - fourgonnette/ - XR3i/ - Turbo / - furgón/ - XR3i/ - Turbo

²⁾ without sensor ring / senza sensori / sans secours ABS / sin anillo sensor ABS

³⁾ - Van/ - XR3i / - furgone/ - XR3i / - fourgonnette/ - XR3i / - furgón/ - XR3i

⁴⁾ - Van / - furgone / - fourgonnette / - furgón

⁵⁾ - SCS/ - Turbo/ - Van / - SCS/ - Turbo/ - furgone / - SCS/ - Turbo/ - fourgonnette / - SCS/ - Turbo/ - furgón

⁶⁾ to change only by pairs / sostituire solo a coppie / à changer seulement par paires / cambiar solamente por parejas

⁷⁾ - SCS/ - Van/ - XR3i / - SCS/ - furgone/ - XR3i / - SCS/ - fourgonnette/ - XR3i / - SCS/ - furgón/ - XR3i

⁸⁾ + SCS/ - Van / + SCS/ - furgone / + SCS/ - fourgonnette / + SCS/ - furgón









⁹⁾ with controlled catalytic con. / con regolazione del catalizzatore / avec catalyseur réglé / con catalizador regulado

FORD ESCORT / ORION (86-90)															
	1.6 D			01.86	04.86	24.3728-0615.2	590615		L=1210						
	1.6 D			02.87	07.88										
	XR3i			01.86	04.86										
	1.4			02.87	08.90	24.3728-0622.2	590622		L=1360						
	1.6 D			08.88	03.89										
1.8 D			04.89	08.90											
XR3i			02.87	08.90											
FORD ESCORT / ORION (91-94)															
	1.3			09.90	01.95	24.2123-1606.3	010386		- ABS	Thz 23,81					
	1.4			09.90	01.95										
	1.6			09.90	01.95										
	1.8 D			09.90	01.95										
	1.8 TD	66		02.93	01.95										
	2.0 RS Cosworth T. alle Typen			06.92	01.95										
	RS 2000			09.90	01.95										
	RS 2000 4x4			05.91	01.95										
1.1			09.90	01.95	24.3541-1707.5	240067		D=54, - Halter	BDX						
1.3 Kastenw.			09.90	01.95											
1.3 Kombi			09.90	01.95											
1.3 Lim.			09.90	01.95											
1.4			09.90	01.95											
1.6			09.90	01.95											
1.8 D			09.90	01.95											
1.8 i 16V	77		01.92	01.95											
1.8 TD			02.93	01.95											
1.8 i 16V RS 2000	96		01.92	01.95											
			05.91	01.95	11.0441-6007.2	250146		Dichtungssatz	ATE						
			11.0101-5407.2	260011											
			11.8171-0008.1	990049											
2.0 RS Cosworth T.			09.92	01.95	11.0441-6007.2	250146		Dichtungssatz	ATE						
			11.0101-5407.2	260011											
			11.8171-0008.1	990049											
			11.8116-0073.1	390498				Führungsbolzen	ATE						
								Haltefeder	ATE						
	1.1			09.90	01.95	13.0460-3965.2	603965		+ Feder ³⁾	23300 18,0 +					
	1.3			09.90	01.95										
	1.4			09.90	01.95										
	1.6			09.90	01.95										
	1.8 D			09.90	01.95										
	1.8 i 16V	77		01.92	01.95										
	1.8 TD			02.93	01.95										
	1.8 i 16V RS 2000	96		01.92	01.95										
				05.91	01.95						13.0460-7040.2	607040		20907 18,0 +	ATE
				05.91	01.95										
	1.1			09.90	01.95	24.0110-0196.1	410196			240 10,0 8,0 +B					
	1.3 Lim.			09.90	01.95										
	1.1			09.90	01.95										
	1.3 Kastenw.			09.90	01.95										
	1.3 Kombi			09.90	01.95										
	1.3 Lim.			09.90	01.95										
	1.4			09.90	01.95										
	1.6			09.90	01.95										
	1.8 D			09.90	01.95										
	1.8 i 16V	77		01.92	01.95										
1.8 TD			02.93	01.95											
1.8 i 16V RS 2000	96		01.92	01.95	24.0124-0125.1	424125		260 24,2 22,2 V							
			05.91	01.95											
			05.91	01.95											
2.0 RS Cosworth T.			09.92	01.95	24.0124-0148.1	424148		278 24,0 22,2 V							
alle Typen			09.90	01.95											
					24.5129-0395.3	330582		L=395							
					24.5129-0396.3	330583		L=395							
	1.3			09.90	01.95	24.0711-1323.1	360019	2		Radsensor L=902					
	1.4			09.90	01.95										
	1.8 D			09.90	01.95										
	1.8 TD			02.93	01.95										
	1.6			09.90	01.95	13.0460-4058.2	604058			21832 14,9					
	1.8 D			09.90	01.95										
	1.8 i 16V			01.92	01.95										
	1.8 TD			02.93	01.95										
	RS 2000			05.91	01.95										
					13.0460-0436.2	610436			Belagsatz-Zubehör						
	1.6			09.90	01.95	24.0110-0213.1	410213			270 10,0 8,6					
	1.8 D			09.90	01.95										
	1.8 i 16V			01.92	01.95										
	1.8 TD			02.93	01.95										
	RS 2000			05.91	01.95										
	1.4			09.90	01.95	24.5303-0455.3	330588	2		L=455					
	alle Typen			09.90	01.95										
	1.6			09.90	01.95	24.0711-1333.3	360020	2		Radsensor L=952					
	1.8 i 16V			01.92	01.95										
	RS 2000			05.91	01.95										

1) uncontrolled catalytic conv. / senza regolazione del catalizzatore / sauf catalyseur réglé / sin catalizador regulado

2) - ABS/ - 1,8 i-16V / - ABS/ - 1,8 i-16V / - ABS/ - 1,8 i-16V / - ABS/ - 1,8 i-16V / - ABS/ - 1,8 i-16V

3) + spring / + molla / + ressort / + muelle

FORD ESCORT / ORION (91-94)											
	1.1			09.90	01.95	- ABS	24.3220-1112.3	020223		Rz 20,64	
	1.3 Lim.			09.90	01.95	- ABS					
	1.4 Lim.			09.90	01.95	- ABS/ + Schaltgetriebe ¹⁾					
	1.3 Kombi			09.90	01.95	- ABS	24.3219-1107.3	020338	nur paarweise austauschen ²⁾	Rz 19,05	
	1.4 Cabrio			09.90	01.95	- ABS				LUC	
	1.4 Kombi			09.90	01.95	- ABS					
	1.4 Lim.			09.90	01.95	- ABS/ + Automatikgetriebe ³⁾					
	1.6			09.90	01.95	- ABS					
	1.8 D			09.90	01.95	- ABS/ - Kastenwagen ⁴⁾					
	1.8 i 16V	77		01.92	01.95	- ABS					
1.8 TD			02.93	01.95	- ABS						
	1.1			09.90	01.95	+ ABS	24.3222-1117.3	020272		Rz 22,20	
	1.3			09.90	01.95	+ ABS					
	1.4			09.90	01.95	+ ABS					
	1.4 Kastenw.			09.90	01.95						
	1.8 D Kastenw.			09.90	01.95	- ABS					
		1.1			09.90	12.93	- ABS	03.0137-0237.2	650237		180 x 32 HEB
		1.3 Lim.			09.90	12.93	- ABS				
		1.4 Lim.			09.90	12.93	- ABS/ + Schaltgetriebe ¹⁾				
		1.1			01.94	01.95	- ABS	03.0137-0237.2	650237		180 x 32 HEB
		1.3 Lim.			01.94	01.95	- ABS	03.0137-9217.2	669217		Bremsbacken-Zubehör
1.4 Lim.				01.94	01.95	- ABS/ + Schaltgetriebe ¹⁾				LUC	
1.1				09.90	12.93	+ ABS	03.0137-0238.2	650238		203 x 38 HEB	
1.3				09.90	12.93	+ ABS	03.0137-9124.2	669124		Bremsbacken-Zubehör	
1.3 Kombi				09.90	12.93	- ABS					
1.4				09.90	12.93	+ ABS					
1.4 Cabrio			09.90	12.93	- ABS						
1.4 Kombi			09.90	12.93	- ABS						
1.4 Lim.			09.90	12.93	- ABS/ + Automatikgetriebe ³⁾						
1.6			09.90	12.93	- ABS						
1.8 D			09.90	12.93	- ABS/ - Kastenwagen ⁴⁾						
1.8 i 16V	77		01.92	12.93	- ABS						
1.8 TD			02.93	12.93	- ABS						
	1.1			01.94	01.95	+ ABS	03.0137-0238.2	650238		203 x 38 HEB	
	1.3			01.94	01.95	+ ABS	03.0137-9251.2	669251		Bremsbacken-Zubehör	
	1.3 Kombi			01.94	01.95	- ABS					
	1.4			01.94	01.95	+ ABS					
	1.4 Cabrio			01.94	01.95	- ABS					
	1.4 Kombi			01.94	01.95	- ABS					
	1.4 Lim.			01.94	01.95	- ABS/ + Automatikgetriebe ³⁾					
	1.6			01.94	01.95	- ABS					
	1.8 D			01.94	01.95	- ABS/ - Kastenwagen ⁴⁾					
	1.8 i 16V	77		01.94	01.95	- ABS					
1.8 TD			01.94	01.95	- ABS						
	1.4 Kastenw.			09.90	01.95		03.0137-0282.2	650282		229 x 45 HEB	
	1.8 D Kastenw.			09.90	01.95	- ABS	03.0137-9184.2	669184		Bremsbacken-Zubehör	
		1.1			09.90	01.95	- ABS	24.0218-0024.2	480079	ohne Sensorring ⁵⁾	180/181 x 44 - Lager
		1.3 Lim.			09.90	01.95	- ABS	24.0218-0724.2	480206	ohne Sensorring ⁵⁾	180/181 x 44 + Lager
		1.4 Lim.			09.90	01.95	- ABS/ + Schaltgetriebe ¹⁾				
		1.1			09.90	01.95	+ ABS	24.0220-3004.2	480023	ohne Sensorring ⁵⁾	203/204 x 49
		1.3			09.90	01.95	+ ABS				
		1.3 Kombi			09.90	01.95	- ABS				
		1.4			09.90	01.95	+ ABS				
		1.4 Cabrio			09.90	01.95	- ABS				
1.4 Kombi				09.90	01.95	- ABS					
1.4 Lim.				09.90	01.95	- ABS/ + Automatikgetriebe ³⁾					
1.6			09.90	01.95	- ABS						
1.8 D			09.90	01.95	- ABS/ - Kastenwagen ⁴⁾						
1.8 i 16V	77		01.92	01.95	- ABS						
1.8 TD			02.93	01.95	- ABS						
	1.1			09.90	12.93	- ABS	03.0520-2120.3	692120		20,64/180x32 TopKit	
	1.3 Lim.			09.90	12.93	- ABS				LUC	
	1.4 Lim.			09.90	12.93	- ABS/ + Schaltgetriebe ¹⁾					
	1.1			01.94	01.95	- ABS	03.0520-7020.3	697020		20,64/180x32 TopKit	
	1.3 Lim.			01.94	01.95	- ABS				LUC	
	1.4 Lim.			01.94	01.95	- ABS/ + Schaltgetriebe ¹⁾					
	1.1			01.94	01.95	+ ABS	03.0520-6122.3	696122		22,20/203x38 TopKit	
	1.3			01.94	01.95	+ ABS				LUC	
	1.4			01.94	01.95	+ ABS					
	1.3 Kombi			09.90	12.93	- ABS	03.0520-1119.3	691119		19,05/203x38 TopKit	
1.4 Cabrio			09.90	12.93	- ABS				LUC		
1.4 Kombi			09.90	12.93	- ABS						
1.4 Lim.			09.90	12.93	- ABS/ + Automatikgetriebe ³⁾						
1.6			09.90	12.93	- ABS						
1.8 D			09.90	12.93	- ABS/ - Kastenwagen ⁴⁾						
1.8 i 16V	77		01.92	12.93	- ABS						
1.8 TD			02.93	12.93	- ABS						
	1.3 Kombi			01.94	01.95	- ABS	03.0520-5619.3	695619		19,05/203x38 TopKit	
	1.4 Cabrio			01.94	01.95	- ABS				LUC	
	1.4 Kombi			01.94	01.95	- ABS					
	1.4 Lim.			01.94	01.95	- ABS/ + Automatikgetriebe ³⁾					
	1.6			01.94	01.95	- ABS					
	1.8 D			01.94	01.95	- ABS/ - Kastenwagen ⁴⁾					
	1.8 i 16V	77		01.94	01.95	- ABS					
	1.8 TD			01.94	01.95	- ABS					





















¹⁾ - ABS/ + manual transmission / - ABS/+ scatola camb.velocità / - ABS/ + transmission mécanique / - ABS/ + cambio de velocidad

²⁾ to change only by pairs / sostituire solo a coppie / à changer seulement par paires / cambiar solamente por parejas

³⁾ - ABS/ + autom.transmission / - ABS/+ scatola cambio autom. / - ABS/ + transmission automatique / - ABS/ + cambio automático

⁴⁾ - ABS/ - Van / - ABS/ - furgone / - ABS/ - fourgonnette / - ABS/ - furgón

⁵⁾ without sensor ring / senza sensori / sans secours ABS / sin anillo sensor ABS



								
FORD ESCORT / ORION (91-94)								
	1.6 1.8 D 1.8 i 16V 1.8 TD RS 2000		09.90 09.90 01.92 02.93 05.91	01.95 + ABS 01.95 + ABS 01.95 + ABS 01.95 + ABS 01.95	03.0137-9701.2	669701		Bremsbacken-Zubehör
	1.3 1.4 1.6 1.8 D 1.8 i 16V 1.8 TD alle Typen		09.90 09.90 09.90 09.90 09.91 02.93 09.90	01.95 01.95 01.95 01.95 01.95 01.95 01.95	24.3727-0628.2	580628	1 ↑	L=151
	1.3 1.4 1.6 1.8 D 1.8 i 16V 1.8 TD alle Typen		09.90 09.90 09.90 09.90 09.91 02.93 09.90	01.95 - Kastenwagen/-Cosworth/-RS2000 1) 01.95 - Kastenwagen/-Cosworth/-RS2000 1) 01.95 - Kastenwagen/-Cosworth/-RS2000 1) 01.95 - Kastenwagen/-Cosworth/-RS2000 1) 01.95 - Kastenwagen/-Cosworth/-RS2000 1) 01.95 - Kastenwagen/-Cosworth/-RS2000 1) 01.95 - Kastenwagen/-Cosworth/-RS2000 1)	24.3727-0627.2	580627	1 ↓	L=3273
FORD FIESTA (76-89)								
	1.0 1.1 1.3		06.76 06.76 09.77	07.83 + Bremsgerät 2) 07.83 + Bremsgerät 2) 07.83 + Bremsgerät 2)	24.2119-0905.3	010353		Thz 19,05
	1.0 1.1 1.3 1.4 1.6 D	◀ ◀ ◀ ◀ ◀	08.83 08.83 08.83 01.86 03.84	04.89 + Bremsgerät 2) 04.89 + Bremsgerät 2) 08.86 + Bremsgerät 2) 04.89 + Bremsgerät 2) 04.89 + Bremsgerät 2)	24.2120-0905.3	010364		Thz 20,64
	1.0 1.1 1.3 1.4 1.6 D		08.83 08.83 08.83 01.86 03.84	04.89 04.89 08.86 04.89 04.89	11.0441-4805.2 11.0101-5407.2 11.8171-0008.1	250020 260011 990049		Dichtungssatz Hülssensatz Führungsbolzen ATE ATE ATE
	1.6 XR2		09.81	04.89	24.3541-1701.5 11.0441-5402.2 11.0101-5407.2 11.8171-0008.1	240005 250028 260011 990049	☐	D=54, - Halter Dichtungssatz Hülssensatz Führungsbolzen ATE ATE ATE
	1.0 1.1 1.3 1.4 1.6 D		08.83 08.83 08.83 01.86 03.84	04.89 04.89 08.86 04.89 04.89	13.0460-7005.2	607005		20857 17,5 + ATE
	1.6 XR2		09.81	04.89	13.0460-7071.2	607071		20640 17,5 + ATE
	1.0 1.1 1.3 1.4 1.6 D		06.76 06.76 09.77 01.86 03.84	04.89 04.89 08.86 04.89 04.89	24.0110-0148.1	410148		221 10,0 8,7
	1.0 1.1		06.76 06.76	07.83 - Bremskraftregler 3) 07.83 - Bremskraftregler 3)	24.3215-1104.3	020158		Rz 15,87
	1.0 1.1 1.3 1.4		08.83 08.83 08.83 01.86	04.89 04.89 04.89 04.89	24.3217-1114.3	020177		Rz 17,46
	1.0 1.1 1.3 1.4 1.6 D 1.6 XR2		08.83 08.83 08.83 01.86 03.84 02.84	04.89 04.89 04.89 04.89 04.89 04.89	03.0137-0164.2 03.0137-9091.2	650164 669091		178 x 32 AUT Bremsbacken-Zubehör
	1.0 1.1 1.3 1.4 1.6 D 1.6 XR2		06.76 06.76 09.77 01.86 03.84 09.81	04.89 04.89 04.89 04.89 04.89 07.83	24.0217-8001.1	480002	ohne Sensorring 4)	178/179 x 36
	alle Typen		08.83	04.89	24.3727-0617.2	580617	1 ↓	L=2750
	alle Typen		06.76	04.89 + Bremsgerät 2)	24.3728-0623.2	590623		L=650
FORD FIESTA III (89-96)								
	1.1 1.3 1.4 1.8 D	44 44 44	05.89 03.89 03.89 05.89	04.91 - SCS 04.91 - SCS 04.91 - SCS 04.91 - SCS	24.2120-1739.3	010762		Thz 20,64 - Behälter LUC
	1.1 1.3 1.3 Kastenw. 1.4 1.8 D 1.8 D Kastenw.	44 44 44	05.91 05.91 09.91 05.91 05.91 09.91	01.94 - SCS 01.94 - SCS 01.94 - SCS 01.94 - SCS 01.94 - SCS 01.94 - SCS	24.2120-1604.3	010370		Thz 20,64

1) - Van/ - Cosworth/ -RS2000 / - furgone/ - Cosworth/ - RS2000 / - fourgon./ - Cosworth/ - RS2000 / - furgón/ - Cosworth/ - RS2000















2) + booster unit / + servofreno / + servo-frein / + servofreno

3) - brake pressure regulator / - correttore di frenata / - correcteur de freinage / - corrector de frenado















4) without sensor ring / senza sensori / sans secours ABS / sin anillo sensor ABS



































FORD FIESTA III (89-96)																			
	1.1	44	02.94	11.96	- SCS	24.2120-1606.3	010582				Thz 20,64 + Behälter								
	1.3		02.94	11.96	- SCS														
	1.3 Kastenw.		02.94	11.96	- SCS														
	1.4		02.94	11.96	- SCS														
	1.8 D	44	02.94	11.96	- SCS														
	1.8 D Kastenw.		02.94	11.96	- SCS														
	1.0	33	03.89	12.95	+ SCS	24.2122-1603.3	010381				Thz 22,20								
	1.1		05.89	11.96	+ SCS														
	1.3	44	03.89	11.96	+ SCS														
	1.3 Kastenw.		09.91	11.96	+ SCS														
	1.4		03.89	11.96	+ SCS														
	1.6		01.89	11.96	+ SCS														
	1.6 Turbo	96	03.90	10.92	+ SCS														
	1.6 XR2i		03.89	11.96	+ SCS														
	1.6i 16V	65	01.94	11.96	+ SCS														
	1.8 16V	77	02.92	11.96	+ SCS														
	1.8 D	44	05.89	11.96	+ SCS														
	1.8 D Kastenw.		09.91	11.96	+ SCS														
	1.8 XR2i	96	02.92	12.95	+ SCS														
		1.0	33	03.89	10.95								11.3481-8511.2	220337	☐	-	belüftete Scheiben 1)	D=48, - Halter	ATE
		1.1		05.89	10.95														
1.3		44	03.89	10.95															
1.3 Kastenw.			09.91	10.95															
1.4			03.89	10.95															
1.6			01.89	10.95															
1.6 Turbo		96	03.90	10.92															
1.6 XR2i			03.89	10.95															
1.6i 16V		65	01.94	10.95															
1.8 16V		77	02.92	10.95															
1.8 D		44	05.89	10.95															
1.8 D Kastenw.			09.91	10.95															
1.8 XR2i		96	02.92	10.95															
1.0		33	11.95	11.96		11.3481-8513.2	220335	☐	-	belüftete Scheiben 1)	D=48, - Halter	ATE							
1.1			11.95	11.96															
1.3		44	11.95	11.96															
1.3 Kastenw.			11.95	11.96															
1.4			11.95	11.96															
1.6			11.95	11.96															
1.6 XR2i			11.95	11.96															
1.6i 16V		65	11.95	11.96															
1.8 16V	77	11.95	11.96																
1.8 D	44	11.95	11.96																
1.8 D Kastenw.		11.95	11.96																
1.8 XR2i	96	11.95	11.96																
1.0	33	11.95	11.96		11.0230-0687.1								260106	☐	-	belüftete Scheiben 1)	Halter	ATE	
1.1		11.95	11.96																
1.3	44	11.95	11.96																
1.3 Kastenw.		11.95	11.96																
1.4		11.95	11.96																
1.6		11.95	11.96																
1.6 XR2i		11.95	11.96																
1.6i 16V	65	11.95	11.96																
1.8 16V	77	11.95	11.96																
1.8 D	44	11.95	11.96																
1.8 D Kastenw.		11.95	11.96																
1.8 XR2i	96	11.95	11.96																
1.0	33	03.89	12.95			13.0460-7073.2	607073	☐	-	belüftete Scheiben 1)	21202 16,9 +	ATE							
1.1		05.89	11.96																
1.3	44	03.89	11.96																
1.3 Kastenw.		09.91	11.96																
1.4		03.89	11.96																
1.6		01.89	11.96																
1.6 Turbo	96	03.90	10.92																
1.6 XR2i		03.89	11.96																
1.6i 16V	65	01.94	11.96																
1.8 16V	77	02.92	11.96																
1.8 D	44	05.89	11.96																
1.8 D Kastenw.		09.91	11.96																
1.8 XR2i	96	02.92	12.95																
1.0	33	03.89	10.95		24.0110-0196.1								410196	☐	-	belüftete Scheiben 1)	240 10,0 8,0 +B	ATE	
1.1		05.89	10.95																
1.3	44	03.89	10.95																
1.3 Kastenw.		09.91	10.95																
1.4		03.89	10.95																
1.6		01.89	10.95																
1.6 Turbo	96	03.90	10.92																
1.6 XR2i		03.89	10.95																
1.6i 16V	65	01.94	10.95																
1.8 16V	77	02.92	10.95																
1.8 D	44	05.89	10.95																
1.8 D Kastenw.		09.91	10.95																
1.8 XR2i	96	02.92	10.95																
1.0	33	11.95	12.95			24.0112-0141.1	412141	☐	-	belüftete Scheiben 1)	239 12,0 10,0 +B	ATE							
1.1		11.95	11.96																
1.3	44	11.95	11.96																
1.3 Kastenw.		11.95	11.96																
1.4		11.95	11.96																
1.6		11.95	11.96																
1.6 XR2i		11.95	11.96																
1.6i 16V	65	11.95	11.96																
1.8 16V	77	11.95	11.96																
1.8 D	44	11.95	11.96																
1.8 D Kastenw.		11.95	11.96																
1.8 XR2i	96	11.95	12.95																
1.0	33	03.89	12.95		24.5303-0400.3								330404	2			L=400		
1.1		05.89	11.96																
1.3	44	03.89	11.96																
1.3 Kastenw.		09.91	11.96																

1) - ventilated discs / - dischi ventilati / - disques ventilés / - disco ventilado
2) + ventilated discs / + dischi ventilati / + disques ventilés / + disco ventilado

									
FORD FIESTA III (89-96)									
	1.4			03.89	11.96	24.5303-0400.3	330404	2	L=400
	1.6			01.89	11.96				
	1.6 Turbo	96		03.90	10.92				
	1.6 XR2i			03.89	11.96				
	1.6i 16V	65		01.94	11.96				
	1.8 16V	77		02.92	11.96				
	1.8 D	44		05.89	11.96				
	1.8 D Kastenw.			09.91	11.96				
	1.8 XR2i	96		02.92	12.95				
	1.0	33		03.89	12.95	24.5302-0295.3	330403	2	- SCS
	1.1			05.89	11.96	24.5306-0295.3	330662	2	+ SCS
	1.3	44		03.89	11.96				
	1.4			03.89	11.96				
	1.6			01.89	11.96				
	1.6 Turbo	96		03.90	10.92				
	1.6 XR2i			03.89	11.96				
	1.6i 16V	65		01.94	11.96				
	1.8 16V	77		02.92	11.96				
	1.8 D	44		05.89	11.96				
	1.8 XR2i	96		02.92	12.95				
	1.3 Kastenw.			09.91	11.96	24.5304-0280.3	330589	2	
	1.8 D Kastenw.			09.91	11.96				L=280
	1.0	33		03.89	12.93	24.3217-1601.3	020180		Rz 17,46
	1.1			05.89	12.93				
	1.3	44		03.89	12.93				
	1.4			03.89	12.93				
	1.8 D	44		05.89	11.96				
	1.6			01.89	11.96	24.3219-1106.3	020192		Rz 19,05
	1.6 Turbo	96		03.90	10.92				
	1.6 XR2i			03.89	11.96				
	1.6i 16V	65		01.94	11.96				
	1.8 16V	77		02.92	11.96				
	1.8 XR2i	96		02.92	12.95				
	1.0	33		01.94	12.95	24.3219-1717.3	020415		Rz 19,05
	1.1			01.94	11.96				
	1.3	44		01.94	11.96				
	1.4			01.94	11.96				
	1.0	33		03.89	12.95	24.3222-1111.3	020266		Rz 22,20
	1.1			05.89	11.96				
	1.3	44		03.89	11.96				
	1.3 Kastenw.			09.91	01.94				
	1.4			03.89	11.96				
	1.6			01.89	11.96				
	1.6 Turbo	96		03.90	10.92				
	1.6 XR2i			03.89	11.96				
	1.6i 16V	65		01.94	11.96				
	1.8 16V	77		02.92	11.96				
	1.8 D	44		05.89	11.96				
	1.8 D Kastenw.			09.91	01.94				
	1.8 XR2i	96		02.92	12.95				
	1.3 Kastenw.			02.94	11.96	24.3222-1117.3	020272		Rz 22,20
	1.8 D Kastenw.			02.94	11.96				
	1.0	33		03.89	12.95	03.0137-0235.2	650235		180 x 32 AUT
	1.1			05.89	11.96	03.0137-9121.2	669121		Bremsbacken-Zubehör
	1.3	44		03.89	11.96				
	1.4			03.89	11.96				
	1.8 D	44		05.89	11.96				
	1.0	33		03.89	12.95	03.0137-0236.2	650236		203 x 39 AUT
	1.1			05.89	11.96	03.0137-9120.2	669120		Bremsbacken-Zubehör
	1.3	44		03.89	11.96				
	1.3 Kastenw.			09.91	11.96				
	1.4			03.89	11.96				
	1.6			01.89	11.96				
	1.6 Turbo	96		03.90	10.92				
	1.6 XR2i			03.89	11.96				
	1.6i 16V	65		01.94	11.96				
	1.8 16V	77		02.92	11.96				
	1.8 D	44		05.89	11.96				
	1.8 D Kastenw.			09.91	11.96				
	1.8 XR2i	96		02.92	12.95				
	1.0	33		03.89	12.95	24.0218-0024.2	480079		180/181 x 44 - Lager
	1.1			05.89	11.96	24.0218-0724.2	480206		180/181 x 44 + Lager
	1.3	44		03.89	11.96				
	1.4			03.89	11.96				
	1.8 D	44		05.89	11.96				
	1.0	33		03.89	12.95	24.0220-3002.2	480021		203/204 x 46,5
	1.1			05.89	11.96				
	1.3	44		03.89	11.96				
	1.4			03.89	11.96				
	1.6			01.89	11.96				
	1.6 Turbo	96		03.90	10.92				
	1.6 XR2i			03.89	11.96				
	1.6i 16V	65		01.94	11.96				
	1.8 16V	77		02.92	11.96				
	1.8 D	44		05.89	11.96				
	1.8 XR2i	96		02.92	12.95				

1) without sensor ring / senza sensori / sans secours ABS / sin anillo sensor ABS

								
FORD FIESTA III (89-96)								
	1.3 Kastenw. 1.8 D Kastenw.			09.91 09.91	11.96 11.96	24.0220-3008.2	480075	203/204 x 45
	1.0 1.1 1.3 1.4 1.8 D	33 44 44		03.89 05.89 03.89 03.89 05.89	12.93 12.93 12.93 12.93 11.96	-SCS -SCS -SCS -SCS -SCS	03.0520-1417.3	691417 17,46/180x32 TopKit BDX
	1.0 1.1 1.3 1.4	33 44		01.94 01.94 01.94 01.94	12.95 11.96 11.96 11.96	-SCS -SCS -SCS -SCS	03.0520-4419.3	694419 19,05/180x32 TopKit
	1.0 1.1 1.3 1.3 Kastenw. 1.4 1.6 1.6 Turbo 1.6 XR2i 1.6i 16V 1.8 16V 1.8 D 1.8 D Kastenw. 1.8 XR2i	33 44 96 65 77 44 96		03.89 05.89 03.89 09.91 03.89 01.89 03.90 03.89 01.94 02.92 05.89 09.91 02.92	12.95 11.96 11.96 01.94 11.96 11.96 10.92 11.96 11.96 11.96 11.96 11.96 12.95	+SCS +SCS +SCS +SCS +SCS +SCS +SCS +SCS +SCS +SCS +SCS +SCS +SCS	03.0420-2922.3	682922 22,20/203x39 Kit BDX
	1.0 1.1 1.3 1.4 1.6 1.6 Turbo 1.6 XR2i 1.6i 16V 1.8 16V 1.8 D 1.8 XR2i	33 44 96 65 77 44 96		03.89 05.89 03.89 03.89 01.89 03.90 03.89 01.94 02.92 05.89 02.92	12.95 11.96 11.96 11.96 11.96 10.92 11.96 11.96 11.96 11.96 12.95		24.3727-0628.2	580628 1 ↑ L=151
	1.0 1.1 1.3 1.4 1.6 1.6 Turbo 1.6 XR2i 1.8 D	33 44 96 44		03.89 05.89 03.89 03.89 01.89 03.90 03.89 05.89	07.91 07.91 07.91 07.91 07.91 07.91 07.91 07.91		24.3727-0623.2	580623 1 ↓ L=3268
	1.0 1.1 1.3 1.4 1.6 1.6 Turbo 1.6 XR2i 1.8 16V 1.8 D 1.8 XR2i	33 44 96 77 44 96		08.91 08.91 08.91 08.91 08.91 08.91 08.91 02.92 08.91 02.92	01.94 01.94 01.94 01.94 10.92 01.94 01.94 01.94 01.94 01.94		24.3727-0626.2	580626 1 ↓ L=3242
	1.0 1.1 1.3 1.4 1.6 1.6 XR2i 1.6i 16V 1.8 16V 1.8 D 1.8 XR2i	33 44 96 65 77 44 96		02.94 02.94 02.94 02.94 02.94 02.94 01.94 02.94 02.94 02.94	12.95 11.96 11.96 11.96 11.96 11.96 11.96 11.96 11.96 12.95		24.3727-0662.2	580662 1 ↓ L=3255
	1.3 Kastenw. 1.8 D Kastenw.			09.91 09.91	11.96 11.96		24.3727-0633.2	580633 1 ↓ L=3930
	1.0 1.1 1.3 1.3 Kastenw. 1.4 1.6 1.6 Turbo 1.6 XR2i 1.8 16V 1.8 D 1.8 D Kastenw. 1.8 XR2i	33 44 44 44 96 77 44 96		03.89 05.89 03.89 09.91 03.89 01.89 03.90 03.89 02.92 05.89 09.91 02.92	12.93 12.93 12.93 12.93 12.93 12.93 10.92 12.93 12.93 12.93 12.93 12.93		24.3728-0601.2	590601 L=673
FORD MAVERICK (93-96)								
	2.4 i 2.7 TD			02.93 02.93	09.96 09.96		24.2123-1726.3	010557 Thz 23,81 - Behälter







								
FORD MAVERICK (93-96)								
	2.4 i 2.7 TD			02.93 09.96 02.93 09.96	13.0460-5959.2	605959		21481 15,5 LUC
	2.4 i 2.7 TD			02.93 09.96 02.93 09.96	24.0126-0109.1	426109		277 26,0 24,0 V
	2.4 i 2.7 TD			02.93 09.96 + 2 türig ¹⁾ 02.93 09.96 + 2 türig ¹⁾	24.3222-1717.3	020443		Rz 22,20
	2.4 i 2.7 TD			02.93 09.96 + 4 türig ²⁾ 02.93 09.96 + 4 türig ²⁾	24.3223-1709.3	020444		Rz 23,81
	2.4 i 2.7 TD			02.93 09.96 02.93 09.96	03.0137-0376.2 03.0137-9169.2	650376 669169		254 x 58 HEB Bremsbacken-Zubehör
	2.4 i 2.7 TD			02.93 09.96 02.93 09.96	24.0225-4014.1	480155		254/255,5 x 65
FORD MONDEO I (93-96)								
	1.6 i 16V 1.8 i 16V 1.8 TD 2.0 i 16V 2.0 i 16V 4x4			01.96 09.96 - ABS 01.96 09.96 - ABS 01.96 09.96 - ABS 01.96 09.96 - ABS 01.96 09.96 - ABS	24.2125-1706.3	010496		THz 25,40
	1.6 i 16V 1.8 i 16V 1.8 TD 2.0 i 16V 2.0 i 16V 4x4 2.5 i 24V			01.93 12.95 + ABS 01.93 12.95 + ABS 01.93 12.95 + ABS 01.93 12.95 + ABS 04.93 12.95 + ABS 08.94 12.95	24.2125-1707.3	010497		THz 25,40
	1.6 i 16V 1.8 i 16V 1.8 TD 2.0 i 16V 2.0 i 16V 4x4 2.5 i 24V			01.96 09.96 + ABS 01.96 09.96 + ABS 01.96 09.96 + ABS 01.96 09.96 + ABS 01.96 09.96 + ABS	24.2125-1708.3	010498		THz 25,40
	1.6 i 16V 1.8 i 16V 1.8 TD 2.0 i 16V			01.93 09.96 01.93 09.96 01.93 09.96 01.93 09.96	24.3601-8527.5 24.3601-8528.5 11.0441-6007.2 11.0101-5407.2 11.8171-0008.1 11.8116-0301.1	240503 240504 250146 260011 990049 390610	 	D=60, - Halter ATE D=60, - Halter ATE Dichtungssatz ATE Hülzensatz ATE Führungsbolzen ATE Haltefeder ATE
	2.0 i 16V 4x4 2.5 i 24V			04.93 09.96 08.94 09.96	11.0441-6007.2 11.0101-5407.2 11.8171-0008.1 11.8116-0143.1	250146 260011 990049 390513	2	Dichtungssatz ATE Hülzensatz ATE Führungsbolzen ATE Haltefeder ATE
	1.6 i 16V 1.8 i 16V 1.8 TD 2.0 i 16V			01.93 09.96 01.93 09.96 01.93 09.96 01.93 09.96	13.0460-7057.2 13.0460-7056.2	607057 607056		21394 17,5 + ATE 21396 17,5 +/WK ATE
	2.0 i 16V 4x4 2.5 i 24V			04.93 09.96 08.94 09.96	13.0460-7165.2 13.0460-7163.2	607165 607163		21358 19,8 + ATE 21910 19,8 +/WK ATE
	1.6 i 16V 1.8 i 16V 1.8 TD 2.0 i 16V			01.93 09.96 01.93 09.96 01.93 09.96 01.93 09.96	24.0124-0120.1 24.0324-0120.1	424120 524120		260 24,0 22,2 V +B 260 24,0 22,2 V +B PD
	2.0 i 16V 4x4 2.5 i 24V			04.93 09.96 08.94 09.96	24.0124-0149.1	424149		278 24,1 22,2 V +B
	1.6 i 16V 1.8 i 16V 1.8 TD 2.0 i 16V 2.0 i 16V 4x4 2.5 i 24V			01.93 09.96 01.93 09.96 01.93 09.96 01.93 09.96 04.93 09.96 08.94 09.96	83.7114-0376.3	330373	2	L=370
	1.8 i 16V Lim. 1.8 TD Lim. 2.0 i 16V Lim. 2.5 i 24V Lim.			01.93 09.96 01.93 09.96 01.93 09.96 08.94 09.96	24.3364-1703.5 24.3364-1704.5	240309 240310	 	D=36, - Halter BOS D=36, - Halter BOS
	1.8 i 16V Kombi 1.8 TD Kombi 2.0 i 16V Kombi 2.5 i 24V Kombi			01.93 09.96 01.93 09.96 01.93 09.96 08.94 09.96	24.3364-1705.5 24.3364-1706.5	240311 240312	 	D=36, - Halter BOS D=36, - Halter BOS
	1.8 i 16V 1.8 TD 2.0 i 16V 2.0 i 16V 4x4 2.5 i 24V			01.93 09.96 01.93 09.96 01.93 09.96 04.93 09.96 08.94 09.96	13.0460-3963.2 13.0460-3964.2 13.0460-0428.2	603963 603964 610428	- Ghia Modelle ³⁾ + Ghia Modelle ⁴⁾	21586 15,0 BDX 23410 15,0 +/WK BDX Belagsatz-Zubehör BDX
	1.8 i 16V 1.8 TD 2.0 i 16V 2.0 i 16V 4x4 2.5 i 24V			01.93 09.96 01.93 09.96 01.93 09.96 04.93 09.96 08.94 09.96	24.0120-0146.1 24.0320-0146.1	420146 520146		253 20,0 18,0 V +B 253 20,0 18,0 V +B PD

1) + 2 door / + 2 porte / + 2 portes / + 2 puertas

2) + 4 door / + 4 porte / + 4 portes / + 4 puertas

3) - Ghia model / - modello Ghia / - modèles Ghia / - modelo Ghia

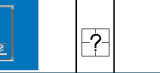
4) + Ghia model / + modello Ghia / + modèles Ghia / + modelo Ghia

































FORD MONDEO I (93-96)												
	1.6 i 16V Lim.			01.93	12.95	83.6227-0281.3	330424	2	+ HA-Trommelbremse ¹⁾	L=280		
	1.8 i 16V Lim.			01.93	12.95							
	1.8 TD Lim.			01.93	12.95							
	2.0 i 16V 4x4			04.93	12.95							
	2.0 i 16V Lim.			01.93	12.95							
	2.5 i 24V Lim.			08.94	12.95							
		1.6 i 16V Lim.			01.96	09.96	83.6118-0281.3	330483	2	+ HA-Trommelbremse ¹⁾	L=280	
		1.8 i 16V Lim.			01.96	09.96						
		1.8 TD Lim.			01.96	09.96	83.6362-0542.3	330485	2	+ HA-Scheibenbremse ²⁾	L=540	
		2.0 i 16V 4x4			01.96	09.96						
		2.0 i 16V Lim.			01.96	09.96						
		2.5 i 24V Lim.			01.96	09.96						
			1.6 i 16V Kombi			01.93	09.96	83.6114-0300.3	330258	2	+ HA-Trommelbremse ¹⁾	L=300
			1.8 i 16V Kombi			01.93	09.96					
			1.8 TD Kombi			01.93	09.96	24.5164-0315.3	331209	2	+ HA-Scheibenbremse ²⁾	L=315
2.0 i 16V Kombi					01.93	09.96						
2.5 i 24V Kombi					08.94	09.96						
			1.6 i 16V Lim.			01.93	05.94	24.3220-1111.3	020222			Rz 20,64
			1.8 i 16V Lim.			01.93	05.94					
			1.8 TD Lim.			01.93	05.94					
			2.0 i 16V Lim.			01.93	05.94					
	2.5 i 24V Lim.				08.94	12.95						
			1.6 i 16V Lim.			06.94	09.96	24.3222-1114.3	020269			Rz 22,20
			1.8 i 16V Lim.			06.94	09.96					
			1.8 TD Lim.			06.94	09.96	24.3222-1116.3	020271			Rz 22,20
			2.0 i 16V Lim.			06.94	09.96					
			2.5 i 24V Lim.			06.94	09.96					
			1.6 i 16V Kombi			01.93	09.96	03.0137-0253.2	650253			228 x 45 HEB
			1.8 i 16V Kombi			01.93	09.96					
			1.8 TD Kombi			01.93	09.96	03.0137-9153.2	669153			Bremsbacken-Zubehör
			2.0 i 16V Kombi			01.93	09.96					
			2.5 i 24V Kombi			08.94	09.96					
			1.6 i 16V Lim.			06.94	09.96	03.0137-0272.2	650272			203 x 39 HEB
			1.8 i 16V Lim.			06.94	09.96					
			1.8 TD Lim.			06.94	09.96	03.0137-9177.2	669177			Bremsbacken-Zubehör
			2.0 i 16V Lim.			06.94	09.96					
			2.5 i 24V Lim.			06.94	09.96					
			1.6 i 16V Kombi			01.93	09.96	03.0137-0253.2	650253			228 x 45 HEB
			1.8 i 16V Kombi			01.93	09.96					
			1.8 TD Kombi			01.93	09.96	03.0137-9153.2	669153			Bremsbacken-Zubehör
			2.0 i 16V Kombi			01.93	09.96					
			2.5 i 24V Kombi			08.94	09.96					
			1.6 i 16V Lim.			01.93	05.94	24.0222-8014.1	480031			229/230,1 x 54
			1.8 i 16V Lim.			01.93	05.94					
			1.8 TD Lim.			01.93	05.94					
			2.0 i 16V Lim.			01.93	05.94					
			2.5 i 24V Lim.			08.94	12.95					
			1.6 i 16V Lim.			06.94	09.96	24.0220-3006.1	480062			203/204,5 x 48,5
			1.8 i 16V Lim.			06.94	09.96					
			1.8 TD Lim.			06.94	09.96	24.0222-8014.1	480031			229/230,1 x 54
			2.0 i 16V Lim.			06.94	09.96					
			2.5 i 24V Lim.			06.94	09.96					
			1.6 i 16V Kombi			01.93	09.96	03.0520-2320.3	692320			20,64/228x45 TopKit
			1.8 i 16V Kombi			01.93	09.96					
			1.8 TD Kombi			01.93	09.96	03.0420-2122.3	682122			22,20/203x39 Kit
			2.0 i 16V Kombi			01.93	09.96					
			2.5 i 24V Kombi			06.94	09.96	03.0520-2222.3	692222			22,20/228x45 TopKit
		2.0 i 16V Kombi			01.93	09.96						
		2.5 i 24V Kombi			01.93	09.96						
			1.6 i 16V Lim.			01.93	09.96	24.3727-0638.2	580638	1	+ HA-Trommelbremse ¹⁾	L=270
			1.8 i 16V Lim.			01.93	09.96					
			1.8 TD Lim.			01.93	09.96					
2.0 i 16V 4x4					04.93	09.96						
2.0 i 16V Lim.					01.93	09.96						
2.5 i 24V Lim.					08.94	09.96	24.3727-0644.2	580644	2	+ HA-Scheibenbremse ²⁾	L=1611	
1.6 i 16V Kombi					01.93	09.96						
1.8 i 16V Kombi					01.93	09.96	24.3727-0639.2	580639	2	+ HA-Trommelbremse ¹⁾	L=1611	
1.8 TD Kombi				01.93	09.96							
2.0 i 16V Kombi				01.93	09.96	24.3727-0641.2	580641	2	+ HA-Scheibenbremse ²⁾	L=1647		
2.5 i 24V Kombi				08.94	09.96							
2.5 i 24V Kombi				08.94	09.96							
	1.6 i 16V Lim.				01.93	12.95	03.6043-1774.3	320031		THz primär Anschluß M10x1 ³⁾	BRE 3/30	
	1.8 i 16V Lim.				01.93	12.95						
	2.0 i 16V Lim.				01.93	12.95						
	1.6 i 16V Lim.			01.96	09.96	03.6043-1784.3	320034		THz sekundär Anschluß M12x1 ⁴⁾	BRE 3/30		
	1.8 i 16V Lim.			01.96	09.96							
	2.0 i 16V Lim.			01.96	09.96							
	1.6 i 16V Kombi			01.93	09.96	03.6043-1954.3	320226	2		BRE 3/30		
	1.8 i 16V Kombi			01.96	09.96							
	2.0 i 16V Kombi			01.96	09.96							
	1.6 i 16V Kombi			01.93	12.95	03.6043-1773.3	320030		THz primär Anschluß M10x1 ³⁾	BRE 3/25		
	1.8 i 16V Kombi			01.93	12.95							
	1.8 i 16V Kombi			01.93	12.95	03.6043-1783.3	320033		THz sekundär Anschluß M12x1 ⁴⁾	BRE 3/25		
	1.8 i 16V Kombi			01.93	12.95							

¹⁾ + RA drum brake / + P freno a tamburo / + frein à tambour essieu AR / + ET-tambores de freno

²⁾ + RA disc brake / + P disco freno / + frein à disque essieu AR / + ET-disco de freno

³⁾ TMC primary: connection M10x1 / PFT primario: attacco M10x1 / MCT raccordement primaire M10x1 / CMT primario: conexión M10x1

⁴⁾ TMC secondary: connection M12x1 / PFT secundario: attacco M12x1 / MCT raccordement secondaire M12x1 / CMT secundario: conexión M12x1























										
FORD MONDEO I (93-96)										
	1.8 TD		01.93	12.95	- ABS	03.6043-1773.3	320030	THz primär Anschluß M10x1 ¹⁾	BRE 3/25	ATE
	2.0 i 16V Kombi		01.93	12.95	- ABS	03.6043-1783.3	320033	THz sekundär Anschluß M12x1 ²⁾	BRE 3/25	ATE
	1.6 i 16V Kombi		01.96	09.96	- ABS	03.6043-1953.3	320201		BRE 3/45	ATE
	1.8 i 16V Kombi		01.96	09.96	- ABS					
	1.8 TD Kombi		01.96	09.96	- ABS					
	2.0 i 16V Kombi		01.96	09.96	- ABS					
	1.6 i 16V		01.93	12.95	+ ABS					
	1.8 i 16V		01.93	12.95	+ ABS	03.6043-1776.3	320032	THz primär Anschluß M10x1 ¹⁾	BRE 3/40	ATE
	1.8 TD		01.93	12.95	+ ABS					
	2.0 i 16V		01.93	12.95	+ ABS					
	2.5 i 24V		08.94	12.95						
	1.6 i 16V		01.96	09.96	+ ABS					
	1.8 i 16V		01.96	09.96	+ ABS	03.6043-1956.3	320202		BRE 3/40	ATE
	1.8 TD		01.96	09.96	+ ABS					
	2.0 i 16V		01.96	09.96	+ ABS					
	2.5 i 24V		01.96	09.96						
	1.6 i 16V		08.94	09.96						
	1.8 i 16V		08.94	09.96		24.2419-1723.3	030112		Gz 19,05	
	1.8 TD		08.94	09.96						
	2.0 i 16V		08.94	09.96						
	2.0 i 16V 4x4		04.93	09.96						
	2.5 i 24V		08.94	09.96						
FORD PROBE (91-92)										
	2.2 i		12.90	12.92		13.0460-5932.2	605932		21378 15,0 +/WK	AKE
	2.2 i Turbo		12.90	12.92		13.0460-0313.2	610313		Belagsatz-Zubehör	AKE
	3.0 i V6		12.90	12.92						
	2.2 i		12.90	12.92		24.0124-0105.1	424105		264 24,0 22,0 V	
	2.2 i Turbo		12.90	12.92						
	3.0 i V6		12.90	12.92						
	2.2 i		12.90	12.92		13.0460-5995.2	605995		21558 13,0	
	2.2 i Turbo		12.90	12.92						
	3.0 i V6		12.90	12.92						
	2.2 i		12.90	12.92		24.0110-0181.1	410181		259 10,0 8,0	
	2.2 i Turbo		12.90	12.92						
	3.0 i V6		12.90	12.92						
FORD SCORPIO / GRANADA (GB) (85-91)										
	alle Typen		03.85	01.92	- 2,9 i-24V	11.0441-6003.2	250037	2	Dichtungssatz Hülssensatz Führungsbolzen Haltefeder	ATE ATE ATE
	2.9 i 24V		01.91	01.92		11.0441-6007.2	250146			
	alle Typen		03.85	01.92	- 2,9 i-24V	11.0101-5407.2	260011	2	Dichtungssatz Hülssensatz Führungsbolzen Haltefeder	ATE ATE ATE ATE
	alle Typen		11.8171-0008.1	990049		11.8171-0008.1	990049			
	alle Typen		03.85	01.92	- 2,9 i-24V	11.8116-0052.1	390496	2	20907 18,0 + 20909 18,0 +/WK	ATE ATE
	alle Typen		11.8116-0073.1	390498		13.0460-7040.2	607040			
	alle Typen		03.85	11.86		13.0460-7041.2	607041	2	260 24,2 22,2 V	
	alle Typen		12.86	01.92	- 2,9 i-24V	24.0124-0109.1	424109			
	alle Typen		03.85	01.92		24.0124-0121.1	424121	2	260 24,0 22,2 V	
	alle Typen		03.85	01.92		24.5305-0310.3	331326			
	alle Typen		03.85	01.92		24.0711-1129.1	360002	2	L=310	
	alle Typen		03.85	01.92		24.0711-1129.1	360002			
	alle Typen		03.85	01.92	- 2,9 i-24V	24.0711-1129.1	360002	2	Radsensor L=830	
	alle Typen		03.85	01.92	- 2,9 i-24V	24.3434-1601.5	240019			
	alle Typen		03.85	01.92	- 2,9 i-24V	24.3434-1602.5	240020	2	D=43, - Halter D=43, - Halter Bremsattel-Zubehör	LUC LUC LUC
	alle Typen		03.85	01.92	- 2,9 i-24V	24.0101-4301.2	260047			
	alle Typen		03.85	01.92		13.0460-2928.2	602928	2	20981 13,8 /S 21079 13,8 +/WK/S	LUC LUC
	alle Typen		03.85	01.92		13.0460-2933.2	602933			
	alle Typen		03.85	01.92	- 2,9 i-24V	24.0110-0186.1	410186	2	253 10,2 8,9	
	alle Typen		03.85	01.92	- 2,9 i-24V	24.5302-0296.3	330476			
	alle Typen		03.85	01.92		83.6327-0180.3	330740	2	L=295 L=180	
	alle Typen		03.85	01.92		24.0711-1301.1	360015			
	alle Typen		03.85	01.92		24.0711-1301.1	360015	2	am Bremsattel ³⁾	
	alle Typen 4x4		03.85	01.92		24.0711-1301.1	360015			
	alle Typen		03.85	04.91		24.3727-0618.2	580618	1	L=3724	
	alle Typen		03.85	04.91		24.3728-0625.2	590625			
	1.8		03.85	09.87	+ Klimaanlage ⁴⁾	24.3728-0625.2	590625		L=1405	
	1.8		10.87	01.92						
	2.0		03.85	09.87	+ Klimaanlage ⁴⁾					
	2.0		10.87	01.92						
	2.0 i		03.85	01.92						

¹⁾ TMC primary: connection M10x1 / PFT primario: attacco M10x1 / MCT raccordement primaire M10x1 / CMT primario: conexión M10x1















²⁾ TMC secondary: connection M12x1 / PFT secundario: attacco M12x1 / MCT raccordement secondaire M12x1 / CMT secundario: conexión M12x1

³⁾ on the brake caliper / sulla pinza freno / sur l'étrier de frein / a la pinza de freno

⁴⁾ + air conditioning / + aria condizionata / + air conditionné / + aire acondicionado

        												
FORD SCORPIO / GRANADA (GB) (92-94)												
	2.0 i			02.92	09.94		11.0441-6003.2	250037			Dichtungssatz	
	2.4 i V6			02.92	09.94		11.0101-5407.2	260011			HülSENSatz	ATE
	2.5 TD			02.92	09.94		11.8171-0008.1	990049			Führungsbolzen	ATE
	2.9 i V6			02.92	09.94		11.8116-0052.1	390496	2		Haltefeder	ATE
	2.9 i 24V			02.92	09.94		11.0441-6007.2	250146			Dichtungssatz	ATE
							11.0101-5407.2	260011			HülSENSatz	ATE
							11.8171-0008.1	990049	2		Führungsbolzen	ATE
							11.8116-0073.1	390498			Haltefeder	ATE
	2.0 i			02.92	07.92		13.0460-7040.2	607040			20907 18,0 +	ATE
	2.4 i V6			02.92	07.92							
	2.5 TD			02.92	07.92							
	2.9 i V6			02.92	07.92							
	2.9 i V6 4x4			08.92	09.94							
	2.0 i			08.92	09.94		13.0460-7057.2	607057			21394 17,5 +	ATE
	2.4 i V6			08.92	09.94		13.0460-7060.2	607060			21638 17,5 +/WK	ATE
	2.5 TD			08.92	09.94							
	2.5 TD Kombi			02.92	09.94							
	2.5 TD Lim.			02.92	09.94							
	2.9 i V6			08.92	09.94							
	2.0 i			02.92	09.94		24.0124-0121.1	424121			260 24,0 22,2 V	
	2.4 i V6			02.92	09.94							
	2.5 TD			02.92	09.94							
	2.5 TD Kombi			02.92	09.94							
	2.5 TD Lim.			02.92	09.94							
	2.0 i			02.92	09.94		24.5305-0310.3	331326	2		L=310	
	2.4 i V6			02.92	09.94							
	2.5 TD			02.92	09.94							
	2.5 TD Kombi			02.92	09.94							
	2.5 TD Lim.			02.92	09.94							
	2.9 i 24V			02.92	09.94							
	2.9 i V6			02.92	09.94							
2.9 i V6 4x4			02.92	09.94								
	2.0 i			02.92	09.94		13.0460-2928.2	602928			20981 13,8 /S	LUC
	2.4 i V6			02.92	09.94							
	2.5 TD			02.92	09.94							
	2.5 TD Kombi			02.92	09.94							
	2.5 TD Lim.			02.92	09.94							
	2.0 i Lim.			02.92	09.94		24.0110-0186.1	410186			253 10,2 8,9	
	2.4 i V6 Lim.			02.92	09.94							
	2.5 TD Lim.			02.92	09.94							
	2.9 i V6 Lim.			02.92	09.94							
	2.0 i			02.92	09.94		24.5302-0296.3	330476	2		L=295	
	2.4 i V6			02.92	09.94		83.6327-0180.3	330740	2	am Bremssattel ¹⁾	L=180	
	2.5 TD			02.92	09.94							
	2.5 TD Kombi			02.92	09.94							
	2.5 TD Lim.			02.92	09.94							
	2.9 i 24V			02.92	09.94							
	2.9 i V6			02.92	09.94							
2.9 i V6 4x4			02.92	09.94								
	2.0 i			02.92	09.94		24.3727-0642.2	580642	1	↓	L=3760	
	2.4 i V6			02.92	09.94							
	2.5 TD			02.92	09.94							
	2.5 TD Kombi			02.92	09.94							
	2.5 TD Lim.			02.92	09.94							
	2.9 i 24V			02.92	09.94							
FORD SIERRA (82-86)												
	1.3			08.82	12.86	- ABS	24.2122-1713.3	010463			Thz 22,20	
	1.6			08.82	12.86	- ABS						
	1.8			10.84	12.86	- ABS						
	2.0			08.82	12.86	- ABS						
	2.0 i			02.85	12.86	- ABS						
	2.3			08.82	12.86	- ABS						
	2.3 D			08.82	12.86	- ABS						
	1.6 Kombi			05.86	12.86	- ABS	11.0441-5402.2	250028			Dichtungssatz	ATE
	1.8			10.84	12.86	- ABS	11.0101-5407.2	260011			HülSENSatz	ATE
	2.0			08.82	12.86	- ABS	11.8171-0008.1	990049			Führungsbolzen	ATE
	2.0 i			02.85	12.86	- ABS						
	2.3			08.82	12.86	- ABS						
	2.3 D			08.82	12.86	- ABS						
	alle Typen			03.86	12.86	+ ABS/ - Cosworth-Turbo	11.0441-6003.2	250037			Dichtungssatz	ATE
						11.0101-5407.2	260011			HülSENSatz	ATE	
						11.8171-0008.1	990049			Führungsbolzen	ATE	
	2.0 RS Cosworth Turbo			01.86	12.86		13.0441-4015.2	250080			Dichtungssatz	ATE
	2.8 i			02.85	12.86		11.0441-6003.2	250037			Dichtungssatz	ATE
	2.8 XR4i			04.83	03.85		11.0101-5407.2	260011			HülSENSatz	ATE
	1.3			08.82	12.86	- ABS	13.0460-2912.2	602912			20861 17,7 /S	LUC
	1.6			08.82	04.86	- ABS						
	1.6 Lim.			05.86	12.86	- ABS						

¹⁾ on the brake caliper / sulla pinza freno / sur l'étrier de frein / a la pinza de freno

FORD SIERRA (82-86)										
	1.6 Kombi 1.8 2.0 2.0 i 2.3 2.3 D		05.86 10.84 08.82 02.85 08.82 08.82	12.86 12.86 12.86 12.86 12.86 12.86	- ABS - ABS - ABS - ABS - ABS - ABS	13.0460-7071.2 13.0460-7027.2	607071 607027		20640 17,5 + 20783 17,5 +/WK	ATE ATE
	2.8 i Lim. alle Typen		02.85 03.86	12.86 12.86		13.0460-7040.2	607040		20907 18,0 +	ATE
	2.8 i 4x4 2.8 i Kombi 2.8 XR4i		02.85 02.85 04.83	12.86 12.86 03.85		13.0460-7041.2	607041		20909 18,0 +/WK	ATE
	1.6 Kombi 1.8 2.0 2.0 i 2.3 2.3 D		05.86 10.84 08.82 02.85 08.82 08.82	12.86 12.86 12.86 12.86 12.86 12.86	- ABS - ABS - ABS - ABS - ABS - ABS	24.0124-0112.1	424112		240 24,2 22,2 V +B	
	2.8 i 2.8 XR4i alle Typen		02.85 04.83 03.86	12.86 03.85 12.86		24.0124-0113.1	424113		260 24,2 22,2 V	
	2.8 i 4x4		02.85	12.86		24.0124-0151.1	424151		260 24,3 22,8 V	
	1.3 1.6 1.8 2.0 2.0 i 2.3 2.3 D 2.8 i		08.85 08.85 08.85 08.85 08.85 08.85 08.85 08.85	12.86 12.86 12.86 12.86 12.86 12.86 12.86 12.86		24.5305-0310.3	331326	2	L=310	
	2.0 i 2.0 RS Cosworth Turbo 2.8 i 2.8 i 4x4 alle Typen		02.85 01.86 02.85 02.85 03.86	12.86 12.86 12.86 12.86 12.86		24.3434-1601.5 24.3434-1602.5 24.0101-4301.2	240019 240020 260047		D=43, - Halter D=43, - Halter Bremsmittel-Zubehör	LUC LUC LUC
	2.0 i 2.8 i 2.8 i 4x4 alle Typen		02.85 02.85 02.85 03.86	12.86 12.86 12.86 12.86		13.0460-2928.2	602928		20981 13,8 /S	LUC
	2.0 i 2.8 i 2.8 i 4x4 alle Typen		02.85 02.85 02.85 03.86	12.86 12.86 12.86 12.86		24.0110-0115.1	410115		253 10,2 8,9 +B	
	1.3 1.6 1.8 2.0 2.0 i 2.3 2.3 D 2.8 i 2.8 XR4i		08.82 08.82 10.84 08.82 02.85 08.82 08.82 02.85 04.83	12.86 12.86 12.86 12.86 12.86 12.86 12.86 12.86 03.85		24.5302-0296.3	330476	2	L=295	
	2.0 RS Cosworth Turbo 2.8 i 4x4		01.86 02.85	12.86 12.86		83.6327-0180.3	330740	2	L=180	
	1.6 Kombi 1.8 2.0 2.3 2.3 D		08.82 10.84 08.82 08.82 08.82	12.86 12.86 12.86 12.86 12.86	- ABS - ABS - ABS - ABS - ABS	24.3220-1112.3	020223		9" Bremse 1)	Rz 20,64
	2.8 XR4i		04.83	03.85	- ABS	24.3222-1117.3	020272		10" Bremse 2)	Rz 22,20
	1.6 Kombi 1.8 2.0 2.3 2.3 D		08.82 10.84 08.82 08.82 08.82	12.86 12.86 12.86 12.86 12.86	- ABS - ABS - ABS - ABS - ABS	03.0137-0157.2 03.0137-9046.2	650157 669046		229 x 58 HEB Bremsbacken-Zubehör	LUC LUC
	1.3 1.6 Lim.		08.82 08.82	12.86 12.86	- ABS - ABS	24.0220-3001.2	480020		203/204 x 45	
	1.6 Kombi 1.8 2.0 2.3 2.3 D		08.82 10.84 08.82 08.82 08.82	12.86 12.86 12.86 12.86 12.86	- ABS - ABS - ABS - ABS - ABS	24.0222-8010.2	480027		229/229,4 x 64	
	1.6 Kombi 1.8 2.0 2.3 2.3 D		08.82 10.84 08.82 08.82 08.82	12.86 12.86 12.86 12.86 12.86	- ABS - ABS - ABS - ABS - ABS	03.0420-0220.3	680220		20,64/229x58 Kit	LUC
	1.3 1.6 1.8 2.0 2.0 i 2.3 2.3 D 2.8 i		04.84 04.84 10.84 04.84 02.85 04.84 04.84 02.85	12.86 12.86 12.86 12.86 12.86 12.86 12.86 12.86		24.3727-0616.2	580616	1 	L=3313	

1) 9" brake / servofreno da 9" / frein de 9" / freno de 9"

2) 10" brake / servofreno da 10" / frein de 10" / freno de 10"

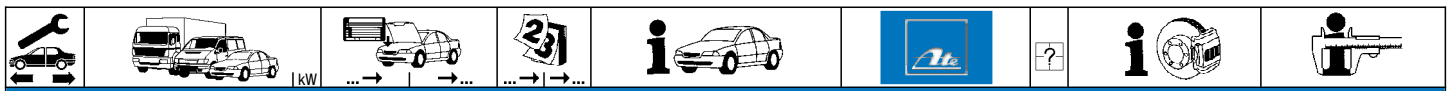

FORD SIERRA (82-86)

	2.8 XR4i		04.84	03.85		24.3727-0616.2	580616	1 ↓		L=3313
	2.0 RS Cosworth Turbo		01.86	12.86		24.3727-0624.2	580624	1 ↓		L=3375
	2.8 i 4x4		02.85	12.86						
	1.8	↖	10.84	12.86		24.3728-0625.2	590625			L=1405
	2.0	↖	08.82	12.86	Reihenmotor/ - Klimaanlage ¹⁾					

FORD SIERRA (87-93)

	1.6 Kombi	↖	01.87	02.93	- ABS	24.2122-1713.3	010463			Thz 22,20
	1.6 Lim.	↖	01.87	02.93	- ABS					
	1.8 Kombi	↖	01.87	03.93	- ABS					
	1.8 Lim.	↖	01.87	02.93	- ABS					
	1.8 TD Kombi	↖	08.88	02.93	- ABS					
	1.8 TD Lim.	↖	01.90	02.93	- ABS					
	2.0 i Kombi	↖	01.87	02.93	- ABS					
	2.0 i Lim.	↖	01.87	02.93	- ABS/ + HA-Trommelbremse ²⁾					
	2.0 Kombi	↖	01.87	02.93	- ABS					
	2.0 Lim.	↖	01.87	02.93	- ABS					
	2.3 D Kombi	↖	01.87	02.93	- ABS					
	2.3 D Lim.	↖	01.87	02.93	- ABS					
	1.6 Kombi		01.87	02.93	- ABS	11.0441-5402.2	250028			Dichtungssatz
	1.6 Lim.		01.87	02.93	- ABS	11.0101-5407.2	260011			Hülsensatz
	1.8 Kombi		01.87	02.93	- ABS	11.8171-0008.1	990049			Führungsbolzen
	1.8 Lim.		01.87	02.93	- ABS					
	1.8 TD Kombi		08.88	02.93	- ABS					
	1.8 TD Lim.		01.90	02.93	- ABS					
	2.0 i 4x4		01.90	02.93	- ABS					
	2.0 i Kombi		01.87	02.93	- ABS					
	2.0 i Lim.		01.87	02.93	- ABS					
	2.0 Kombi		01.87	02.93	- ABS					
	2.0 Lim.		01.87	02.93	- ABS					
	2.3 D Kombi		01.87	02.93	- ABS					
	2.3 D Lim.		01.87	02.93	- ABS					
	1.6 Kombi		01.87	02.93	+ ABS	11.0441-6003.2	250037			Dichtungssatz
	1.6 Lim.		01.87	02.93	+ ABS	11.0101-5407.2	260011			Hülsensatz
	1.8 Kombi		01.87	02.93	+ ABS	11.8171-0008.1	990049			Führungsbolzen
	1.8 Lim.		01.87	02.93	+ ABS	11.8116-0052.1	390496	2		Haltefeder
	1.8 TD Kombi		08.88	02.93	+ ABS					
	1.8 TD Lim.		01.90	02.93	+ ABS					
	2.0 i 4x4		01.90	02.93	+ ABS					
	2.0 Kombi		01.87	02.93	+ ABS					
	2.0 Lim.		01.87	02.93	+ ABS					
	2.3 D Kombi		01.87	02.93	+ ABS					
	2.3 D Lim.		01.87	02.93	+ ABS					
	2.8 i 4x4 Kombi		01.87	02.93						
	2.8 i Kombi		01.87	02.93						
	2.8 i Lim.		01.87	08.88						
	2.9 i 4x4 Kombi		08.88	02.93						
	2.9 i 4x4 Lim.		08.88	02.93						
	2.9 i Kombi		08.88	02.93						
	2.9 i Lim.		08.88	02.93						
	2.0 RS Cosworth Turbo		01.87	12.89		13.0441-4015.2	250080			Dichtungssatz
	2.0 RS Cosworth T.4x4		01.90	02.93		11.0441-6007.2	250146			Dichtungssatz
						11.0101-5407.2	260011			Hülsensatz
						11.8171-0008.1	990049			Führungsbolzen
	1.6 Kombi		01.87	02.93	- ABS	13.0460-7071.2	607071			20640 17,5 +
	1.6 Lim.		01.87	02.93	- ABS					
	1.8 Kombi		01.87	02.93	- ABS					
	1.8 Lim.		01.87	02.93	- ABS					
	1.8 TD Kombi		08.88	02.93	- ABS					
	1.8 TD Lim.		01.90	02.93	- ABS					
	2.0 i 4x4		01.90	02.93	- ABS					
	2.0 i Kombi		01.87	02.93	- ABS					
	2.0 i Lim.		01.87	02.93	- ABS					
	2.0 Kombi		01.87	02.93	- ABS					
	2.0 Lim.		01.87	02.93	- ABS					
	2.3 D Kombi		01.87	02.93	- ABS					
	2.3 D Lim.		01.87	02.93	- ABS					
	1.6 Kombi		01.87	02.93	+ ABS	13.0460-7040.2	607040			20907 18,0 +
	1.6 Lim.		01.87	02.93	+ ABS					
	1.8 Kombi		01.87	02.93	+ ABS					
	1.8 Lim.		01.87	02.93	+ ABS					
	1.8 TD Kombi		08.88	02.93	+ ABS					
	1.8 TD Lim.		01.90	02.93	+ ABS					
	2.0 i 4x4		01.90	02.93	+ ABS					
	2.0 i Kombi		01.87	02.93	+ ABS					
	2.0 i Lim.		01.87	02.93	+ ABS					
	2.0 Kombi		01.87	02.93	+ ABS					
	2.0 Lim.		01.87	02.93	+ ABS					
	2.3 D Kombi		01.87	02.93	+ ABS					
	2.3 D Lim.		01.87	02.93	+ ABS					
	2.8 i 4x4 Kombi		01.87	02.93						
	2.8 i Kombi		01.87	02.93						
	2.8 i Lim.		01.87	08.88						
	2.9 i 4x4 Kombi		08.88	02.93						
	2.9 i 4x4 Lim.		08.88	02.93						

¹⁾ R engine/ - air conditioning / motore di serie/ - aria condizionata / mot.en ligne/ - air conditionné / motor de RV-aire acondicionado
²⁾ - ABS/ + RA drum brake / - ABS/ + P freno a tamburo / - ABS/ + fr. à tambour essieu AR / - ABS/ + ET tambores de freno



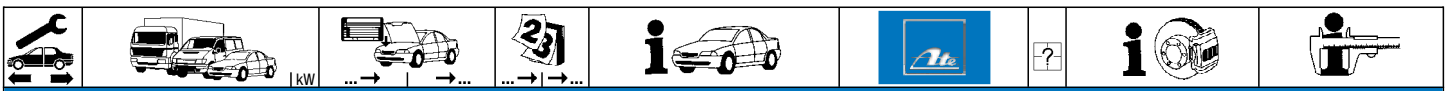









FORD SIERRA (87-93)











	<p>1.6 Kombi 1.6 Lim. 1.8 Kombi 1.8 Lim. 1.8 TD Kombi 1.8 TD Lim. 2.0 i 4x4 Kombi 2.0 i 4x4 Lim. 2.0 i Kombi 2.0 i Lim. 2.0 Kombi 2.0 Lim. 2.0 RS Cosworth Turbo 2.8 i 4x4 Kombi 2.8 i Kombi 2.8 i Lim. 2.9 i 4x4 Kombi 2.9 i 4x4 Lim. 2.9 i Kombi 2.9 i Lim.</p>			<p>01.87 02.93 + ABS 01.87 02.93 + ABS 01.87 02.93 + ABS 01.87 02.93 + ABS 08.88 02.93 + ABS 01.90 02.93 + ABS 05.89 02.93 01.90 02.93 01.87 02.93 - ABS 01.87 02.93 - ABS 01.87 02.93 + ABS 01.87 02.93 + ABS 01.87 02.93 + ABS 01.87 12.89 01.87 02.93 01.87 02.93 01.87 08.88 08.88 02.93 08.88 02.93 08.88 02.93 08.88 02.93</p>	<p>13.0460-2928.2 602928</p>		<p>20981 13,8 /S LUC</p>
	<p>1.6 Kombi 1.6 Lim. 1.8 Kombi 1.8 Lim. 1.8 TD Kombi 1.8 TD Lim. 2.0 i 4x4 Kombi 2.0 i 4x4 Lim. 2.0 i Kombi 2.0 i Lim. 2.0 Kombi 2.0 Lim. 2.8 i 4x4 Kombi 2.8 i Kombi 2.8 i Lim. 2.9 i 4x4 Kombi 2.9 i 4x4 Lim. 2.9 i Kombi 2.9 i Lim.</p>		<p>01.87 02.93 + ABS 01.87 02.93 + ABS 01.87 02.93 + ABS 01.87 02.93 + ABS 08.88 02.93 + ABS 01.90 02.93 + ABS 05.89 02.93 01.90 02.93 01.87 02.93 - ABS 01.87 02.93 - ABS 01.87 02.93 + ABS 01.87 02.93 + ABS 01.87 02.93 01.87 02.93 01.87 02.93 08.88 02.93 08.88 02.93 08.88 02.93 08.88 02.93</p>	<p>24.0110-0115.1 410115</p>		<p>253 10,2 8,9 +B</p>	
	<p>1.6 Kombi 1.6 Lim. 1.8 Kombi 1.8 Lim. 1.8 TD Kombi 1.8 TD Lim. 2.0 i Kombi 2.0 i Lim. 2.0 Kombi 2.0 Lim. 2.3 D Kombi 2.3 D Lim.</p>		<p>01.87 02.93 01.87 02.93 01.87 02.93 01.87 02.93 08.88 02.93 01.90 02.93 01.87 02.93 01.87 02.93 01.87 02.93 01.87 02.93 01.87 02.93</p>	<p>24.5302-0296.3 330476</p>	<p>2</p>	<p>L=295</p>	
	<p>1.6 Kombi 1.6 Lim. 1.8 Kombi 1.8 Lim. 1.8 TD Kombi 1.8 TD Lim. 2.0 i 4x4 Kombi 2.0 i 4x4 Lim. 2.0 i Kombi 2.0 i Lim. 2.0 Kombi 2.0 Lim. 2.0 RS Cosworth Turbo 2.8 i 4x4 Kombi 2.8 i Kombi 2.8 i Lim. 2.9 i 4x4 Kombi 2.9 i 4x4 Lim. 2.9 i Kombi 2.9 i Lim.</p>		<p>01.87 02.93 + ABS 01.87 02.93 + ABS 01.87 02.93 + ABS 01.87 02.93 + ABS 08.88 02.93 + ABS 01.90 02.93 + ABS 05.89 02.93 + ABS 01.90 02.93 + ABS 01.87 02.93 + ABS 01.87 02.93 + ABS 01.87 02.93 + ABS 01.87 02.93 + ABS 01.87 12.89 01.87 02.93 01.87 02.93 01.87 02.93 08.88 02.93 08.88 02.93 08.88 02.93 08.88 02.93</p>	<p>83.6327-0180.3 330740</p>	<p>2</p>	<p>L=180</p>	
	<p>1.8 Lim. 1.8 TD Lim. 2.0 i 4x4 Lim. 2.0 i Lim. 2.0 Lim. 2.3 D Lim. 2.9 i 4x4 Lim.</p>		<p>01.87 02.93 - ABS 01.90 02.93 - ABS 01.90 02.93 - ABS 01.87 02.93 - ABS 01.87 02.93 - ABS 01.87 02.93 - ABS 08.88 02.93 - ABS</p>	<p>24.3220-1112.3 020223</p>		<p>9" Bremse ¹⁾ Rz 20,64</p>	
	<p>1.6 Kombi 1.8 Kombi 1.8 TD Kombi 2.0 i 4x4 Kombi 2.0 i Kombi 2.0 Kombi 2.3 D Kombi 2.8 i 4x4 Kombi 2.9 i 4x4 Kombi</p>		<p>01.87 02.93 - ABS 01.87 02.93 - ABS 08.88 02.93 - ABS 05.89 02.93 - ABS 01.87 02.93 - ABS 01.87 02.93 - ABS 01.87 02.93 - ABS 01.87 02.93 - ABS 08.88 02.93 - ABS</p>	<p>24.3222-1117.3 020272</p>		<p>10" Bremse ²⁾ Rz 22,20</p>	

¹⁾ 9" brake / servofreno da 9" / frein de 9" / freno de 9"

²⁾ 10" brake / servofreno da 10" / frein de 10" / freno de 10"

KW		
FORD SIERRA (87-93)													
	1.6 Kombi 1.8 Kombi 1.8 Lim. 1.8 TD Kombi 1.8 TD Lim. 2.0 i Kombi 2.0 i Lim. 2.0 Kombi 2.0 Lim. 2.3 D Kombi 2.3 D Lim.			01.87 01.87 01.87 08.88 01.90 01.87 01.87 01.87 01.87 01.87	02.93 02.93 02.93 02.93 02.93 02.93 02.93 02.93 02.93 02.93	- ABS - ABS - ABS - ABS - ABS - ABS - ABS - ABS - ABS - ABS	03.0137-0157.2 03.0137-9046.2	650157 669046				229 x 58 HEB Bremsbacken-Zubehör	LUC LUC
	1.6 Lim. 1.6 Kombi 1.8 Kombi 1.8 Lim. 1.8 TD Kombi 1.8 TD Lim. 2.0 i Kombi 2.0 i Lim. 2.0 Kombi 2.0 Lim. 2.3 D Kombi 2.3 D Lim.			01.87 01.87 01.87 08.88 01.90 01.87 01.87 01.87 01.87 01.87 01.87	02.93 02.93 02.93 02.93 02.93 02.93 02.93 02.93 02.93 02.93 02.93	- ABS - ABS - ABS - ABS - ABS - ABS - ABS - ABS - ABS - ABS - ABS	24.0220-3001.2 24.0222-8010.2	480020 480027			203/204 x 45 229/229,4 x 64		
	1.8 Lim. 1.8 TD Lim. 2.0 i 4x4 Lim. 2.0 i Lim. 2.0 Lim. 2.3 D Lim. 2.8 i Lim. 2.9 i 4x4 Lim. 2.9 i Lim.			01.87 01.90 01.90 01.87 01.87 01.87 01.87 08.88 08.88	02.93 02.93 02.93 02.93 02.93 02.93 02.93 02.93 02.93	- ABS - ABS - ABS - ABS - ABS - ABS - ABS - ABS - ABS	03.0420-0220.3	680220			20,64/229x58 Kit	LUC	
	1.6 Kombi 1.6 Lim. 1.8 Kombi 1.8 Lim. 1.8 TD Kombi 1.8 TD Lim. 2.0 i 4x4 Kombi 2.0 i 4x4 Lim. 2.0 i Kombi 2.0 i Lim. 2.0 Kombi 2.0 Lim. 2.3 D Kombi 2.3 D Lim. 2.8 i Kombi 2.8 i Lim.			01.87 01.87 01.87 01.87 08.88 01.90 05.89 01.90 01.87 01.87 01.87 01.87 01.87 01.87 01.87 01.87	02.93 02.93 02.93 02.93 02.93 02.93 02.93 02.93 02.93 02.93 02.93 02.93 02.93 02.93 02.93 02.93	- ABS - ABS - ABS - ABS - ABS - ABS - ABS - ABS - ABS - ABS - ABS - ABS - ABS - ABS - ABS - ABS	24.3727-0616.2	580616	1 ↓		L=3313		
	1.6 Kombi 1.6 Lim. 1.8 Kombi 1.8 Lim. 2.0 i 4x4 Kombi 2.0 i 4x4 Lim. 2.0 i Kombi 2.0 i Lim. 2.0 Kombi 2.0 Lim. 2.0 RS Cosworth T.4x4 2.0 RS Cosworth Turbo 2.3 D Kombi 2.3 D Lim. 2.8 i Kombi 2.8 i Lim. 2.9 i 4x4 Kombi 2.9 i 4x4 Lim. 2.9 i Kombi 2.9 i Lim.			01.87 01.87 01.87 01.87 05.89 01.90 01.87 01.87 01.87 01.87 01.90 01.87 01.87 01.87 01.87 01.87 08.88 08.88 08.88 08.88	02.93 02.93 02.93 02.93 02.93 02.93 02.93 02.93 02.93 02.93 02.93 02.93 02.93 02.93 02.93 02.93 02.93 02.93 02.93 02.93	+ ABS + ABS + ABS + ABS + ABS + ABS + ABS + ABS + ABS + ABS + ABS + ABS + ABS + ABS + ABS + ABS + ABS + ABS + ABS + ABS	24.3727-0624.2	580624	1 ↓		L=3375		
FORD TAUNUS / CORTINA (GB) (70-82)													
	alle Typen			07.70	08.78	+ Bremsgerät 1)	03.2120-5503.3	010124			THz 20,64 + Behälter	ATE	
	alle Typen			09.78	09.82	+ Bremsgerät 1)	03.2120-0151.3	010071			THz 20,64	ATE	
	1.1 1.3 1.6 1.6 1.6 Lim. 2.0 2.0 Lim. 2.3 alle Typen	51 65 51		01.70 07.70 07.70 07.70 07.70 07.70 07.70 08.71 07.70	09.82 09.82 09.82 09.82 09.82 09.82 09.82 09.82 09.82		13.0441-5409.2	250112			Dichtungssatz	ATE	
	1.1 1.3 1.6 1.6	51 65		01.70 07.70 07.70 07.70	09.82 09.82 09.82 09.82		13.0460-7042.2 13.0460-0126.2	607042 610126			20491 15,0 Belagsatz-Zubehör	LUC LUC	
↓													

1) + booster unit / + servofreno / + servo-frein / + servofreno

FORD TAUNUS / CORTINA (GB) (70-82)											
	1.6 Lim. 2.0 2.0 Lim. 2.3 alle Typen	51		07.70 07.70 07.70 08.71 07.70	09.82 09.82 09.82 09.82 09.82		13.0460-7042.2 13.0460-0126.2	607042 610126		20491 15,0 Belagsatz-Zubehör	LUC LUC
	1.1 1.3 1.6 1.6 1.6 Lim. 2.0 2.0 Lim. 2.3 alle Typen	51 65 51		01.70 07.70 07.70 07.70 07.70 07.70 08.71 07.70	09.82 09.82 09.82 09.82 09.82 09.82 09.82 09.82		24.0113-0122.1	413122		248 12,7 11,4	
	1.3 Kombi 1.3 Lim. 1.6 Kombi 1.6 Lim.	51		07.70 07.70 07.70 07.70	03.71 03.71 03.71 03.71	- verstärkte Bremse ¹⁾ - verstärkte Bremse ¹⁾	24.3220-1112.3	020223		Rz 20,64	
	1.3 Kombi 1.3 Lim. 1.6 Kombi			07.70 04.71 07.70	12.75 12.75 12.75	+ verstärkte Bremse ²⁾ + verstärkte Bremse ²⁾	24.3219-1107.3	020338	nur paarweise austauschen ³⁾	Rz 19,05	LUC
	1.6 Lim. 2.0 Lim.	65		07.70 07.70	12.75 12.75		24.3217-1706.3	020044		Rz 17,78	
	1.3 Kombi 1.6 Kombi			01.76 01.76	09.82 09.82	- ⊕	24.3219-1107.3	020338	nur paarweise austauschen ³⁾	Rz 19,05	LUC
	1.6 Kombi 1.6 Lim. 2.0 Lim.			01.76 01.76 01.76	09.82 09.82 09.82	+ ⊕	24.3217-1715.3	020463	9" Bremse/nur paarw. tauschen ⁴⁾	Rz 17,78	LUC
	alle Typen			07.70	07.79		03.0137-9013.2	669013		Bremsbacken-Zubehör	LUC
	alle Typen Lim.			01.76	09.82		24.0220-3001.2	480020		203/204 x 45	
FORD TRANSIT (65-77)											
	FT 100/L FT 115 FT 120 FT 125 FT 130 FT 150 FT 175 FT 190 FT 60 FT 75			11.73 11.73 11.73 11.73 11.73 11.73 11.73 11.73 11.73 11.73	12.77 12.77 12.77 12.77 12.77 12.77 12.77 12.77 12.77 12.77		13.0460-6910.2 13.0460-6911.2 13.0460-0414.2 13.0460-0415.2	606910 606911 610414 610415	+ 2-Kolbensattel ⁵⁾ + 4-Kolbensattel ⁶⁾ + 2-Kolbensattel ⁵⁾ + 4-Kolbensattel ⁶⁾	20364 15,0 +/Zub 20359 18,0 /Zub Belagsatz-Zubehör Belagsatz-Zubehör	AP AP AP AP
	FT 100/L FT 115 FT 120 FT 125 FT 130 FT 150 FT 175 FT 190 FT 60 FT 75			11.73 11.73 11.73 11.73 11.73 11.73 11.73 11.73 11.73 11.73	12.77 12.77 12.77 12.77 12.77 12.77 12.77 12.77 12.77 12.77		24.0114-0100.1	414100		270 14,3 12,9	
	FT 100/L FT 115 FT 120 FT 125 FT 130 FT 150 FT 175 FT 190 FT 60 FT 75			09.65 09.65 09.65 09.65 09.65 09.65 09.65 09.65 09.65 09.65	05.76 05.76 05.76 05.76 05.76 05.76 05.76 05.76 05.76 05.76		83.6104-0450.3	330251	2	+ VA-Trommelbremse ⁷⁾	L=450
	FT 100/L FT 115 FT 120 FT 125 FT 130 FT 150 FT 175 FT 190 FT 60 FT 75			11.68 11.68 11.68 11.68 11.68 11.68 11.68 11.68 11.68 11.68	08.76 08.76 08.76 08.76 08.76 08.76 08.76 08.76 08.76 08.76		83.6104-0450.3	330251	2	+ VA-Trommelbremse ⁷⁾	L=450
	FT 100/L FT 115 FT 120 FT 125 FT 75			06.76 06.76 06.76 08.76 06.76	12.77 12.77 12.77 12.77 12.77		24.3727-0619.2	580619	1		L=2875

¹⁾ - heavy duty brake / - freno rinforzato / - frein renforcé / - freno reforzado

²⁾ + heavy duty brake / + freno rinforzato / + frein renforcé / + freno reforzado

³⁾ to change only by pairs / sostituire solo a coppie / à changer seulement par paires / cambiar solamente por parejas

⁴⁾ 9"br./to change only by pairs / servofr.9"/sosti.solo coppie / fr.d.9"/chang.seulem.p.paires / fr.de 9"/camb.solam.p.parejas

⁵⁾ + 2 piston caliper / + pinza freno a 2 pistoni / + étrier à 2 pistons / + pinza de dos pistones

⁶⁾ + 4 piston caliper / + pinza freno a 4 pistoni / + étrier à 4 pistons / + pinza con 4 pistones

⁷⁾ + FA drum brake / + A freno a tamburo / + frein à tambour ess.AV / + ED tambores de freno

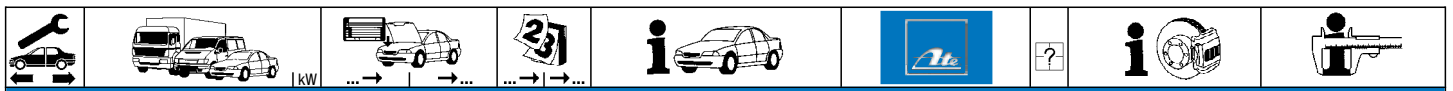















FORD TRANSIT (78-85)

	1.6 Bus 1.6 Kasten 1.6 Pritsche/Fahrg. 2.0 Bus 2.0 Bus 2.0 Kasten 2.0 Kasten 2.0 Kasten 2.0 Pritsche/Fahrg. 2.0 Pritsche/Fahrg. 2.4 D Bus 2.4 D Kasten 2.4 D Pritsche/Fahrg. 2.5 D Bus 2.5 D Kasten 2.5 D Pritsche/Fahrg.	48 48 48 43 55 57 43 55 57 43 57 46 46 46 50 50 50			04.80 04.80 04.80 04.80 04.80 04.80 04.80 04.80 04.80 04.80 04.80 04.80 04.80 04.80 04.80 04.80 04.80	10.85 10.85 10.85 10.85 10.85 10.85 10.85 10.85 10.85 10.85 10.85 10.85 10.85 10.85 10.85 10.85 10.85	FT80/100L/115/120 FT80/100L/115/120 FT80/100L/115/120 FT80/100L/115/120 FT80/100L/115/120 FT80/100L/115/120 FT80/100L/115/120 FT80/100L/115/120 FT80/100L/115/120 FT80/100L/115/120 FT80/100L/115/120 FT80/100L/115/120 FT80/100L/115/120 FT80/100L/115/120 FT80/100L/115/120 FT80/100L/115/120	24.2122-1702.3 010421			THz 22,20	
	1.6 Bus 1.6 Kasten 1.6 Pritsche/Fahrg. 2.0 Bus 2.0 Bus 2.0 Kasten 2.0 Kasten 2.0 Kasten 2.0 Pritsche/Fahrg. 2.0 Pritsche/Fahrg. 2.4 D Bus 2.4 D Kasten 2.4 D Pritsche/Fahrg. 2.5 D Bus 2.5 D Kasten 2.5 D Pritsche/Fahrg.	48 48 48 43 55 57 43 57 43 57 46 46 46 50 50 50			01.78 01.78 01.78 01.78 01.78 01.78 01.78 01.78 01.78 01.78 01.78 01.78 01.78 01.78 01.78 01.78	10.85 10.85 10.85 10.85 10.85 10.85 10.85 10.85 10.85 10.85 10.85 10.85 10.85 10.85 10.85 10.85		13.0460-6910.2 13.0460-6911.2 13.0460-0414.2 13.0460-0415.2	606910 606911 610414 610415	+ 2-Kolbensattel ¹⁾ + 4-Kolbensattel ²⁾ + 2-Kolbensattel ¹⁾ + 4-Kolbensattel ²⁾	20364 15,0 +/Zub 20359 18,0 /Zub Belagsatz-Zubehör Belagsatz-Zubehör	AP AP AP AP
	1.6 Bus 1.6 Kasten 1.6 Pritsche/Fahrg. 2.0 Bus 2.0 Bus 2.0 Kasten 2.0 Kasten 2.0 Kasten 2.0 Pritsche/Fahrg. 2.0 Pritsche/Fahrg. 2.4 D Bus 2.4 D Kasten 2.4 D Pritsche/Fahrg. 2.5 D Bus 2.5 D Kasten 2.5 D Pritsche/Fahrg.	48 48 48 43 55 57 43 57 43 57 46 46 46 50 50 50			01.78 01.78 01.78 01.78 01.78 01.78 01.78 01.78 01.78 01.78 01.78 01.78 01.78 01.78 01.78 01.78	03.80 03.80 03.80 03.80 03.80 03.80 03.80 03.80 03.80 03.80 03.80 03.80 03.80 03.80 03.80 03.80		24.0114-0100.1	414100		270 14,3 12,9	
	1.6 Bus 1.6 Kasten 1.6 Pritsche/Fahrg. 2.0 Bus 2.0 Bus 2.0 Kasten 2.0 Kasten 2.0 Kasten 2.0 Pritsche/Fahrg. 2.0 Pritsche/Fahrg. 2.4 D Bus 2.4 D Kasten 2.4 D Pritsche/Fahrg. 2.5 D Bus 2.5 D Kasten 2.5 D Pritsche/Fahrg.	48 48 48 43 55 57 43 57 43 57 46 46 46 50 50 50			01.78 01.78 01.78 01.78 01.78 01.78 01.78 01.78 01.78 01.78 01.78 01.78 01.78 01.78 01.78 01.78	10.85 10.85 10.85 10.85 10.85 10.85 10.85 10.85 10.85 10.85 10.85 10.85 10.85 10.85 10.85 10.85	FT80/100L/115/120 FT80/100L/115/120 FT80/100L/115/120 FT80/100L/115/120 FT80/100L/115/120 FT80/100L/115/120 FT80/100L/115/120 FT80/100L/115/120 FT80/100L/115/120 FT80/100L/115/120 FT80/100L/115/120 FT80/100L/115/120 FT80/100L/115/120 FT80/100L/115/120 FT80/100L/115/120 FT80/100L/115/120	03.0137-9230.2	669230		Bremsbacken-Zubehör	
	1.6 Bus 1.6 Kasten 1.6 Pritsche/Fahrg. 2.0 Bus 2.0 Bus 2.0 Kasten 2.0 Kasten 2.0 Kasten 2.0 Pritsche/Fahrg. 2.0 Pritsche/Fahrg. 2.4 D Bus 2.4 D Kasten 2.4 D Pritsche/Fahrg. 2.5 D Bus 2.5 D Kasten 2.5 D Pritsche/Fahrg.	48 48 48 43 55 57 43 57 43 57 46 46 46 50 50 50			01.78 01.78 01.78 01.78 01.78 01.78 01.78 01.78 01.78 01.78 01.78 01.78 01.78 01.78 01.78 01.78	10.85 10.85 10.85 10.85 10.85 10.85 10.85 10.85 10.85 10.85 10.85 10.85 10.85 10.85 10.85 10.85	FT80/100L/115/120 FT80/100L/115/120 FT80/100L/115/120 FT80/100L/115/120 FT80/100L/115/120 FT80/100L/115/120 FT80/100L/115/120 FT80/100L/115/120 FT80/100L/115/120 FT80/100L/115/120 FT80/100L/115/120 FT80/100L/115/120 FT80/100L/115/120 FT80/100L/115/120 FT80/100L/115/120 FT80/100L/115/120	24.3727-0619.2	580619	1 ↓	L=2875	

¹⁾ + 2 piston caliper / + pinza freno a 2 pistoni / + étrier à 2 pistons / + pinza de dos pistones
²⁾ + 4 piston caliper / + pinza freno a 4 pistoni / + étrier à 4 pistons / + pinza con 4 pistones



												
FORD TRANSIT (86-91)												
	1.6 Kasten	46	05.89	09.92	24.2123-1756.3	010756	Anschluß M10x1 (3x) ¹⁾	Thz 23,81 - Behälter				
	2.0 Bus	57	05.89	09.92								
	2.0 Bus KAT	57	05.89	09.92								
	2.0 Kasten	57	05.89	09.92								
	2.0 Prits./Fahrg. KAT	57	05.89	09.92								
	2.0 Pritsche/Fahrg.	57	05.89	09.92								
	2.5 D Bus	50	12.85	04.89								
	2.5 D Bus	52	09.88	04.89								
	2.5 D Kasten	50	01.86	04.89								
	2.5 D Kasten	52	10.88	04.89								
	2.5 D Pritsche/Fahrg.	50	01.86	04.89								
	2.5 DI Prits./Fahrg.	52	09.88	04.89								
		1.6 Kasten	46	05.89	09.92	24.2123-1705.3			010440	Anschl.Gew.M10x1(2x)/M12x1(1x) ²⁾	Thz 23,81	
		2.0 Bus	57	05.89	09.92							
2.0 Bus KAT		57	05.89	09.92								
2.0 Kasten		57	05.89	09.92								
2.0 Prits./Fahrg. KAT		57	05.89	09.92								
2.0 Pritsche/Fahrg.		57	05.89	09.92								
2.5 D Bus		50	12.85	04.89								
2.5 D Bus		52	09.88	04.89								
2.5 D Kasten		50	01.86	04.89								
2.5 D Kasten		52	10.88	04.89								
2.5 D Pritsche/Fahrg.		50	01.86	04.89								
2.5 DI Prits./Fahrg.		52	09.88	04.89								
		1.6 Bus	46	12.85	01.89	FT80/100/115/120	13.0460-3944.2	603944	21141 18,0			BDX
		1.6 Kasten	46	09.85	09.92	FT80/100/115/120						
	2.0 Bus	57	11.85	09.92	FT80/100/115/120							
	2.0 Bus KAT	57	12.85	09.92	FT80/100/115/120							
	2.0 Kasten	57	09.85	09.92	FT80/100/115/120							
	2.0 Prits./Fahrg. KAT	57	11.85	09.92	FT80/100/115/120							
	2.0 Pritsche/Fahrg.	57	01.86	09.92	FT80/100/115/120							
	2.5 D Bus	50	12.85	01.89	FT80/100/115/120							
	2.5 D Bus	52	09.88	09.92	FT80/100/115/120							
	2.5 D Kasten	50	01.86	09.91	FT80/100/115/120							
	2.5 D Kasten	52	10.88	09.91	FT80/100/115/120							
	2.5 D Pritsche/Fahrg.	50	01.86	01.89	FT80/100/115/120							
	2.5 DI Prits./Fahrg.	52	09.88	09.92	FT80/100/115/120							
	1.6 Bus	46	12.85	01.89	FT100L/130/160/190/190A							
	1.6 Kasten	46	09.85	09.92	FT100L/130/160/190/190A							
	2.0 Bus	57	11.85	09.92	FT100L/130/160/190/190A							
	2.0 Bus KAT	57	12.85	09.92	FT100L/130/160/190/190A							
	2.0 Kasten	57	09.85	09.92	FT100L/130/160/190/190A							
	2.0 Prits./Fahrg. KAT	57	11.85	09.92	FT100L/130/160/190/190A							
	2.0 Pritsche/Fahrg.	57	01.86	09.92	FT100L/130/160/190/190A							
	2.5 D Bus	50	12.85	01.89	FT100L/130/160/190/190A							
	2.5 D Bus	52	09.88	09.92	FT100L/130/160/190/190A							
	2.5 D Kasten	50	01.86	09.91	FT100L/130/160/190/190A							
	2.5 D Kasten	52	10.88	09.91	FT100L/130/160/190/190A							
2.5 D Pritsche/Fahrg.	50	01.86	01.89	FT100L/130/160/190/190A								
2.5 DI Prits./Fahrg.	52	09.88	09.92	FT100L/130/160/190/190A								
	1.6 Bus	46	12.85	01.89	FT80/100/115/120	24.0114-0103.1	414103	254 14,3 12,9				
	1.6 Kasten	46	09.85	09.92	FT80/100/115/120							
	2.0 Bus	57	11.85	09.92	FT80/100/115/120							
	2.0 Bus KAT	57	12.85	09.92	FT80/100/115/120							
	2.0 Kasten	57	09.85	09.92	FT80/100/115/120							
	2.0 Prits./Fahrg. KAT	57	11.85	09.92	FT80/100/115/120							
	2.0 Pritsche/Fahrg.	57	01.86	09.92	FT80/100/115/120							
	2.5 D Bus	50	12.85	01.89	FT80/100/115/120							
	2.5 D Bus	52	09.88	09.92	FT80/100/115/120							
	2.5 D Kasten	50	01.86	09.91	FT80/100/115/120							
	2.5 D Kasten	52	10.88	09.91	FT80/100/115/120							
	2.5 D Pritsche/Fahrg.	50	01.86	01.89	FT80/100/115/120							
	2.5 DI Prits./Fahrg.	52	09.88	09.92	FT80/100/115/120							
		1.6 Bus	46	12.85	01.89				FT100L/130/160/190/190A	24.0114-0100.1	414100	270 14,3 12,9
1.6 Kasten		46	09.85	09.92	FT100L/130/160/190/190A							
2.0 Bus		57	11.85	09.92	FT100L/130/160/190/190A							
2.0 Bus KAT		57	12.85	09.92	FT100L/130/160/190/190A							
2.0 Kasten		57	09.85	09.92	FT100L/130/160/190/190A							
2.0 Prits./Fahrg. KAT		57	11.85	09.92	FT100L/130/160/190/190A							
2.0 Pritsche/Fahrg.		57	01.86	09.92	FT100L/130/160/190/190A							
2.5 D Bus		50	12.85	01.89	FT100L/130/160/190/190A							
2.5 D Bus		52	09.88	09.92	FT100L/130/160/190/190A							
2.5 D Kasten		50	01.86	09.91	FT100L/130/160/190/190A							
2.5 D Kasten		52	10.88	09.91	FT100L/130/160/190/190A							
2.5 D Pritsche/Fahrg.		50	01.86	01.89	FT100L/130/160/190/190A							
2.5 DI Prits./Fahrg.		52	09.88	09.92	FT100L/130/160/190/190A							
		1.6 Bus	46	12.85	01.89	24.5245-0405.3	330686	2	vertikal Bremssystem ⁵⁾			
	1.6 Kasten	46	09.85	09.92								
	2.0 Bus	57	11.85	09.92								
	2.0 Bus KAT	57	12.85	09.92								
	2.0 Kasten	57	09.85	09.92								
	2.0 Prits./Fahrg. KAT	57	11.85	09.92								
	2.0 Pritsche/Fahrg.	57	01.86	09.92								
	2.5 D Bus	50	12.85	01.89								
	2.5 D Bus	52	09.88	09.92								
	2.5 D Kasten	50	01.86	09.91								
2.5 D Kasten	52	10.88	09.91									

















¹⁾ connection thread M10x1 (3x) / filetto attacco M10x1 (3x) / filet d.raccordem. M10x1 (3x) / rosca de conexión M10x1 (3x)

²⁾ connec.thr.M10x1(2x)/M12x1(1x) / filet.attacM10x1(2x)/M12x1(1x) / filet d.raccordem.M10x1(2x)/M1 / rosc.conex.M10x1(2x)/M12x1(1x)

³⁾ + 2 piston caliper / + pinza freno a 2 pistoni / + étrier à 2 pistons / + pinza de dos pistones

⁴⁾ + 4 piston caliper / + pinza freno a 4 pistoni / + étrier à 4 pistons / + pinza con 4 pistones

⁵⁾ vertical brake system / sistema del freno vertical / système de freinage vertical / sistema de freno vertical

FORD TRANSIT (86-91)										
										
	2.5 D Pritsche./Fahrg. 2.5 DI Prits./Fahrg.	50 52		01.86 09.88	01.89 09.92	24.5245-0405.3	330686	2	vertikal Bremssystem 1)	L=405
	1.6 Bus 1.6 Kasten 2.0 Bus 2.0 Bus KAT 2.0 Kasten 2.0 Prits./Fahrg. KAT 2.0 Pritsche./Fahrg. 2.5 D Bus 2.5 D Bus 2.5 D Kasten 2.5 D Kasten 2.5 D Pritsche./Fahrg. 2.5 DI Prits./Fahrg.	46 46 57 57 57 57 57 50 52 50 52 50 52		12.85 09.85 11.85 12.85 09.85 11.85 01.86 12.85 09.88 01.86 10.88 01.86 09.88	01.89 09.92 09.92 09.92 09.92 09.92 09.92 01.89 09.92 09.91 09.91 01.89 09.92	FT80/100/115/120 FT80/100/115/120 FT80/100/115/120 FT80/100/115/120 FT80/100/115/120 FT80/100/115/120 FT80/100/115/120 FT80/100/115/120 FT80/100/115/120 FT80/100/115/120 FT80/100/115/120 FT80/100/115/120 FT80/100/115/120	03.0137-0254.2 03.0137-9154.2	650254 669154		229 x 45 Bremsbacken-Zubehör
	1.6 Bus 1.6 Kasten 2.0 Bus 2.0 Bus KAT 2.0 Kasten 2.0 Prits./Fahrg. KAT 2.0 Pritsche./Fahrg. 2.5 D Bus 2.5 D Bus 2.5 D Kasten 2.5 D Kasten 2.5 D Pritsche./Fahrg. 2.5 DI Prits./Fahrg.	46 46 57 57 57 57 57 50 52 50 52 50 52		12.85 09.85 11.85 12.85 09.85 11.85 01.86 12.85 09.88 01.86 10.88 01.86 09.88	01.89 09.92 09.92 09.92 09.92 09.92 09.92 01.89 09.92 09.91 09.91 01.89 09.92	FT130/160/190/190A FT130/160/190/190A FT130/160/190/190A FT130/160/190/190A FT130/160/190/190A FT130/160/190/190A FT130/160/190/190A FT130/160/190/190A FT130/160/190/190A FT130/160/190/190A FT130/160/190/190A FT130/160/190/190A FT130/160/190/190A	03.0137-0292.2 03.0137-9195.2	650292 669195		254 x 70/56 Bremsbacken-Zubehör
	1.6 Bus 1.6 Kasten 2.0 Bus 2.0 Bus KAT 2.0 Kasten 2.0 Prits./Fahrg. KAT 2.0 Pritsche./Fahrg. 2.5 D Bus 2.5 D Bus 2.5 D Kasten 2.5 D Kasten 2.5 D Pritsche./Fahrg. 2.5 DI Prits./Fahrg.	46 46 57 57 57 57 57 50 52 50 52 50 52		12.85 09.85 11.85 12.85 09.85 11.85 01.86 12.85 09.88 01.86 10.88 01.86 09.88	01.89 09.92 09.92 09.92 09.92 09.92 09.92 01.89 09.92 09.91 09.91 01.89 09.92	FT80/100/115/120 FT80/100/115/120 FT80/100/115/120 FT80/100/115/120 FT80/100/115/120 FT80/100/115/120 FT80/100/115/120 FT80/100/115/120 FT80/100/115/120 FT80/100/115/120 FT80/100/115/120 FT80/100/115/120 FT80/100/115/120	24.0222-8011.1	480028		229/230 x 54
	1.6 Bus 1.6 Kasten 2.0 Bus 2.0 Bus KAT 2.0 Kasten 2.0 Prits./Fahrg. KAT 2.0 Pritsche./Fahrg. 2.5 D Bus 2.5 D Bus 2.5 D Kasten 2.5 D Kasten 2.5 D Pritsche./Fahrg. 2.5 DI Prits./Fahrg.	46 46 57 57 57 57 57 50 52 50 52 50 52		12.85 09.85 11.85 12.85 09.85 11.85 01.86 12.85 09.88 01.86 10.88 01.86 09.88	01.89 09.92 09.92 09.92 09.92 09.92 09.92 01.89 09.92 09.91 09.91 01.89 09.92	FT80/100/115/120 FT80/100/115/120 FT80/100/115/120 FT80/100/115/120 FT80/100/115/120 FT80/100/115/120 FT80/100/115/120 FT80/100/115/120 FT80/100/115/120 FT80/100/115/120 FT80/100/115/120 FT80/100/115/120 FT80/100/115/120	24.3727-0631.2	580631	1	L=2968
	1.6 Bus 1.6 Kasten 2.0 Bus 2.0 Bus KAT 2.0 Kasten 2.0 Prits./Fahrg. KAT 2.0 Pritsche./Fahrg. 2.5 D Bus 2.5 D Bus 2.5 D Kasten 2.5 D Kasten 2.5 D Pritsche./Fahrg. 2.5 DI Prits./Fahrg.	46 46 57 57 57 57 57 50 52 50 52 50 52		12.85 09.85 11.85 12.85 09.85 11.85 01.86 12.85 09.88 01.86 10.88 01.86 09.88	01.89 09.92 09.92 09.92 09.92 09.92 09.92 01.89 09.92 09.91 09.91 01.89 09.92	FT100L FT100L FT100L FT100L FT100L FT100L FT100L FT100L FT100L FT100L FT100L FT100L FT100L	24.3727-0630.2	580630	1	L=2865
	1.6 Bus 1.6 Kasten 2.0 Bus 2.0 Bus KAT 2.0 Kasten 2.0 Prits./Fahrg. KAT 2.0 Pritsche./Fahrg. 2.5 D Bus 2.5 D Bus 2.5 D Kasten 2.5 D Kasten 2.5 D Pritsche./Fahrg. 2.5 DI Prits./Fahrg.	46 46 57 57 57 57 57 50 52 50 52 50 52		12.85 09.85 11.85 12.85 09.85 11.85 01.86 12.85 09.88 01.86 10.88 01.86 09.88	01.89 09.92 09.92 09.92 09.92 09.92 09.92 01.89 09.92 09.91 09.91 01.89 09.92	FT130/160/190/190A FT130/160/190/190A FT130/160/190/190A FT130/160/190/190A FT130/160/190/190A FT130/160/190/190A FT130/160/190/190A FT130/160/190/190A FT130/160/190/190A FT130/160/190/190A FT130/160/190/190A FT130/160/190/190A FT130/160/190/190A	24.3727-0632.2	580632	1	L=2386

1) vertical brake system / sistema de freno vertical / système de freinage vertical / sistema de freno vertical



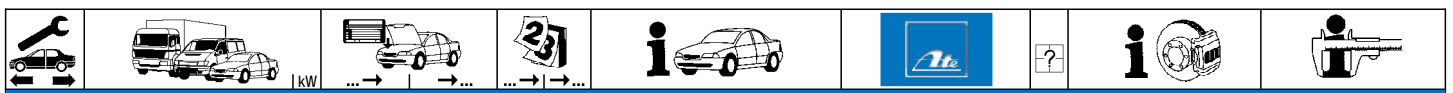

FORD TRANSIT (92-94)

	2.0 Bus 2.0 i Bus 2.0 i Kasten 2.0 Kasten 2.0 Pritsche/Fahrg. 2.5 DI Bus 2.5 DI Bus 2.5 DI Kasten 2.5 DI Kasten 2.5 DI Kasten 2.5 DI Prits./Fahrg. 2.5 DI Prits./Fahrg. 2.5 TD Bus 2.5 TD Bus 2.5 TD Kasten 2.5 TD Prits./Fahrg. 2.5 TD Prits./Fahrg. 2.9 i Bus	66 72 72 66 72 51 59 51 59 63 51 59 63 74 74 63 74 107		09.91 09.91 09.91 09.91 09.91 08.91 09.91 05.91 05.91 10.92 09.91 09.91 10.92 09.91 05.91 11.92 09.91 01.91	09.94 07.94 06.94 06.94 08.94 07.94 06.94 06.94 06.94 06.94 08.94 08.94 07.94 07.94 06.94 08.94 08.94 08.94	24.2123-1724.3 10.6123-0154.3	010566 010578	- ABS + ABS	THz 23,81 THz 23,81	BDX ATE
	2.0 Bus 2.0 i Bus 2.0 i Kasten 2.0 Kasten 2.0 Pritsche/Fahrg. 2.5 DI Bus 2.5 DI Bus 2.5 DI Kasten 2.5 DI Kasten 2.5 DI Kasten 2.5 DI Prits./Fahrg. 2.5 DI Prits./Fahrg. 2.5 TD Bus 2.5 TD Bus 2.5 TD Kasten 2.5 TD Prits./Fahrg. 2.5 TD Prits./Fahrg. 2.9 i Bus	66 72 72 66 72 51 59 51 59 63 51 59 63 74 74 63 74 107		09.91 09.91 09.91 09.91 09.91 08.91 09.91 05.91 05.91 10.92 09.91 09.91 10.92 09.91 05.91 11.92 09.91 01.91	09.94 07.94 06.94 06.94 08.94 07.94 06.94 06.94 06.94 06.94 08.94 08.94 07.94 07.94 06.94 08.94 08.94 08.94	24.3421-1710.5 240698		+ 15" Rad ¹⁾	D=42, - Halter	LUC
	2.0 Bus 2.0 i Bus 2.0 i Kasten 2.0 Kasten 2.0 Pritsche/Fahrg. 2.5 DI Bus 2.5 DI Bus 2.5 DI Kasten 2.5 DI Kasten 2.5 DI Kasten 2.5 DI Prits./Fahrg. 2.5 DI Prits./Fahrg. 2.5 TD Bus 2.5 TD Bus 2.5 TD Kasten 2.5 TD Prits./Fahrg. 2.5 TD Prits./Fahrg. 2.9 i Bus	66 72 72 66 72 51 59 51 59 63 51 59 63 74 74 63 74 107		09.91 09.91 09.91 09.91 09.91 08.91 09.91 05.91 05.91 10.92 09.91 09.91 10.92 09.91 05.91 11.92 09.91 01.91	09.94 07.94 06.94 06.94 08.94 07.94 06.94 06.94 06.94 06.94 08.94 08.94 07.94 07.94 06.94 08.94 08.94 08.94	13.0460-3960.2 13.0460-0427.2	603960 610427	+ 14" Rad ²⁾ + 14" Rad ²⁾	21470 18,0 /WE Belagsatz-Zubehör	BDX BDX
	2.0 Bus 2.0 i Bus 2.0 i Kasten 2.0 Kasten 2.0 Pritsche/Fahrg. 2.5 DI Bus 2.5 DI Bus 2.5 DI Kasten 2.5 DI Kasten 2.5 DI Kasten 2.5 DI Prits./Fahrg. 2.5 DI Prits./Fahrg. 2.5 TD Bus 2.5 TD Bus 2.5 TD Kasten 2.5 TD Prits./Fahrg. 2.5 TD Prits./Fahrg. 2.9 i Bus	66 72 72 66 72 51 59 51 59 63 51 59 63 74 74 63 74 107		09.91 09.91 09.91 09.91 09.91 08.91 09.91 05.91 05.91 10.92 09.91 09.91 10.92 09.91 05.91 11.92 09.91 01.91	09.94 07.94 06.94 06.94 08.94 07.94 06.94 06.94 06.94 06.94 08.94 08.94 07.94 07.94 06.94 08.94 08.94 08.94	13.0460-3959.2 13.0460-0427.2	603959 610427	+ 15" Rad ¹⁾ + 15" Rad ¹⁾	21469 18,0 /WE Belagsatz-Zubehör	BDX BDX
	2.0 Bus 2.0 i Bus 2.0 i Kasten 2.0 Kasten 2.0 Pritsche/Fahrg. 2.5 DI Bus 2.5 DI Bus 2.5 DI Kasten 2.5 DI Kasten 2.5 DI Kasten 2.5 DI Prits./Fahrg. 2.5 DI Prits./Fahrg. 2.5 TD Bus 2.5 TD Bus 2.5 TD Kasten 2.5 TD Prits./Fahrg. 2.5 TD Prits./Fahrg. 2.9 i Bus	66 72 72 66 72 51 59 51 59 63 51 59 63 74 74 63 74 107		09.91 09.91 09.91 09.91 09.91 08.91 09.91 05.91 05.91 10.92 09.91 09.91 10.92 09.91 05.91 11.92 09.91 01.91	09.94 07.94 06.94 06.94 08.94 07.94 06.94 06.94 06.94 06.94 08.94 08.94 07.94 07.94 06.94 08.94 08.94 08.94	24.0124-0131.1	424131	+ 14" Rad ²⁾	254 24,2 22,2 V +B	

¹⁾ + 15" wheel / + ruota 15" / + roue 15" / + rueda 15"

²⁾ + 14" wheel / + ruota 14" / + roue 14" / + rueda 14"



FORD TRANSIT (92-94)										
	2.5 TD Prits./Fahrg.	63		11.92	08.94	24.0124-0131.1	424131		+ 14" Rad 1)	254 24,2 22,2 V +B
	2.5 TD Prits./Fahrg.	74		09.91	08.94					
	2.9 i Bus	107		01.91	08.94					
	2.0 Bus	66		09.91	09.94	24.0124-0132.1	424132		+ 15" Rad 2)	270 24,2 22,2 V +B
	2.0 i Bus	72		09.91	07.94					
	2.0 i Kasten	72		09.91	06.94					
	2.0 Kasten	66		09.91	06.94					
	2.0 Pritsche/Fahrg.	72		09.91	08.94					
	2.5 DI Bus	51		08.91	07.94					
	2.5 DI Bus	59		09.91	07.94					
	2.5 DI Kasten	51		05.91	06.94					
	2.5 DI Kasten	59		05.91	06.94					
	2.5 DI Kasten	63		10.92	06.94					
	2.5 DI Prits./Fahrg.	51		09.91	08.94					
	2.5 DI Prits./Fahrg.	59		09.91	08.94					
	2.5 TD Bus	63		10.92	07.94					
	2.5 TD Bus	74		09.91	07.94					
2.5 TD Kasten	74		05.91	06.94						
2.5 TD Prits./Fahrg.	63		11.92	08.94						
2.5 TD Prits./Fahrg.	74		09.91	08.94						
2.9 i Bus	107		01.91	08.94						
	2.0 Bus	66		09.91	09.94	24.5236-0430.3	330587			L=429
	2.0 i Bus	72		09.91	07.94	24.5236-0429.3	330586			L=429
	2.0 i Kasten	72		09.91	06.94					
	2.0 Kasten	66		09.91	06.94					
	2.0 Pritsche/Fahrg.	72		09.91	08.94					
	2.5 DI Bus	51		08.91	07.94					
	2.5 DI Bus	59		09.91	07.94					
	2.5 DI Kasten	51		05.91	06.94					
	2.5 DI Kasten	59		05.91	06.94					
	2.5 DI Kasten	63		10.92	06.94					
	2.5 DI Prits./Fahrg.	51		09.91	08.94					
	2.5 DI Prits./Fahrg.	59		09.91	08.94					
	2.5 TD Bus	63		10.92	07.94					
	2.5 TD Bus	74		09.91	07.94					
	2.5 TD Kasten	74		05.91	06.94					
	2.5 TD Prits./Fahrg.	63		11.92	08.94					
	2.5 TD Prits./Fahrg.	74		09.91	08.94					
2.9 i Bus	107		01.91	08.94						
	2.0 Bus	66		09.91	09.94	24.5245-0405.3	330686	2	vertikal Bremssystem 3)	L=405
	2.0 i Bus	72		09.91	07.94	24.5245-0398.3	331188	2	diagonal Bremssystem 4)	L=398
	2.0 i Kasten	72		09.91	06.94					
	2.0 Kasten	66		09.91	06.94					
	2.0 Pritsche/Fahrg.	72		09.91	08.94					
	2.5 DI Bus	51		08.91	07.94					
	2.5 DI Bus	59		09.91	07.94					
	2.5 DI Kasten	51		05.91	06.94					
	2.5 DI Kasten	59		05.91	06.94					
	2.5 DI Kasten	63		10.92	06.94					
	2.5 DI Prits./Fahrg.	51		09.91	08.94					
	2.5 DI Prits./Fahrg.	59		09.91	08.94					
	2.5 TD Bus	63		10.92	07.94					
	2.5 TD Bus	74		09.91	07.94					
	2.5 TD Kasten	74		05.91	06.94					
	2.5 TD Prits./Fahrg.	63		11.92	08.94					
	2.5 TD Prits./Fahrg.	74		09.91	08.94					
2.9 i Bus	107		01.91	08.94						
	2.0 Bus	66		09.91	09.94	24.3222-1124.3	020344			Rz 22,20
	2.0 i Bus	72		09.91	07.94					
	2.0 i Kasten	72		09.91	06.94					
	2.0 Kasten	66		09.91	06.94					
	2.0 Pritsche/Fahrg.	72		09.91	08.94					
	2.9 i Bus	107		01.91	08.94					
	2.5 DI Bus	51		08.91	07.94	24.3220-1121.3	020343			Rz 20,64
	2.5 DI Bus	59		09.91	07.94					
	2.5 DI Kasten	51		05.91	06.94					
	2.5 DI Kasten	59		05.91	06.94					
	2.5 DI Kasten	63		10.92	06.94					
	2.5 DI Prits./Fahrg.	51		09.91	08.94					
	2.5 DI Prits./Fahrg.	59		09.91	08.94					
	2.5 TD Bus	63		10.92	07.94					
	2.5 TD Bus	74		09.91	07.94					
	2.5 TD Kasten	74		05.91	06.94					
	2.5 TD Prits./Fahrg.	63		11.92	08.94					
2.5 TD Prits./Fahrg.	74		09.91	08.94						
2.0 Bus	66		09.91	09.94	24.3220-1121.3	020343			Rz 20,64	
2.0 i Bus	72		09.91	07.94						
2.0 i Kasten	72		09.91	06.94						
2.0 Kasten	66		09.91	06.94						
2.0 Pritsche/Fahrg.	72		09.91	08.94						
2.5 DI Bus	51		08.91	07.94						
2.5 DI Bus	59		09.91	07.94						
2.5 DI Kasten	51		05.91	06.94						
2.5 DI Kasten	59		05.91	06.94						
2.5 DI Kasten	63		10.92	06.94						
2.5 DI Prits./Fahrg.	51		09.91	08.94						
2.5 DI Prits./Fahrg.	59		09.91	08.94						
2.5 DI Prits./Fahrg.	59		09.91	08.94						

1) + 14" wheel / + ruota 14" / + roue 14" / + rueda 14"

2) + 15" wheel / + ruota 15" / + roue 15" / + rueda 15"









3) vertical brake system / sistema del freno verticale / système de freinage vertical / sistema de freno vertical

4) diagonal brake system / sistema freno diagonalmente / système de freinage en diagonal / sistema de freno en diagonal

FORD TRANSIT (92-94)

	2.5 TD Bus	63	10.92	07.94	FT130/150S/150L	24.3220-1121.3	020343		Rz 20,64		
	2.5 TD Bus	74	09.91	07.94	FT130/150S/150L						
	2.5 TD Kasten	74	05.91	06.94	FT130/150S/150L						
	2.5 TD Prits./Fahrg.	63	11.92	08.94	FT130/150S/150L						
	2.5 TD Prits./Fahrg.	74	09.91	08.94	FT130/150S/150L						
	2.9 i Bus	107	01.91	08.94	FT130/150S/150L						
	2.0 Bus	66	09.91	09.94	FT190/190A/190EF	24.3225-1103.3	020346				Rz 25,40
	2.0 i Bus	72	09.91	07.94	FT190/190A/190EF						
	2.0 i Kasten	72	09.91	06.94	FT190/190A/190EF						
	2.0 Kasten	66	09.91	06.94	FT190/190A/190EF						
	2.0 Pritsche/Fahrg.	72	09.91	08.94	FT190/190A/190EF						
	2.5 DI Bus	51	08.91	07.94	FT190/190A/190EF						
2.5 DI Bus	59	09.91	07.94	FT190/190A/190EF							
2.5 DI Kasten	51	05.91	06.94	FT190/190A/190EF							
2.5 DI Kasten	59	05.91	06.94	FT190/190A/190EF							
2.5 DI Kasten	63	10.92	06.94	FT190/190A/190EF							
2.5 DI Prits./Fahrg.	51	09.91	08.94	FT190/190A/190EF							
2.5 DI Prits./Fahrg.	59	09.91	08.94	FT190/190A/190EF							
2.5 TD Bus	63	10.92	07.94	FT190/190A/190EF							
2.5 TD Bus	74	09.91	07.94	FT190/190A/190EF							
2.5 TD Kasten	74	05.91	06.94	FT190/190A/190EF							
2.5 TD Prits./Fahrg.	63	11.92	08.94	FT190/190A/190EF							
2.5 TD Prits./Fahrg.	74	09.91	08.94	FT190/190A/190EF							
2.9 i Bus	107	01.91	08.94	FT190/190A/190EF							
	2.0 Bus	66	09.91	09.94	FT80/100S/100L/115/120	03.0137-0290.2	650290	+ Einfachbereifung ¹⁾	254 x 52 Bremsbacken-Zubehör		
	2.0 i Bus	72	09.91	07.94	FT80/100S/100L/115/120						
	2.0 i Kasten	72	09.91	06.94	FT80/100S/100L/115/120						
	2.0 Kasten	66	09.91	06.94	FT80/100S/100L/115/120						
	2.0 Pritsche/Fahrg.	72	09.91	08.94	FT80/100S/100L/115/120						
	2.5 DI Bus	51	08.91	07.94	FT80/100S/100L/115/120						
	2.5 DI Bus	59	09.91	07.94	FT80/100S/100L/115/120						
	2.5 DI Kasten	51	05.91	06.94	FT80/100S/100L/115/120						
	2.5 DI Kasten	59	05.91	06.94	FT80/100S/100L/115/120						
	2.5 DI Kasten	63	10.92	06.94	FT80/100S/100L/115/120						
	2.5 DI Prits./Fahrg.	51	09.91	08.94	FT80/100S/100L/115/120						
	2.5 DI Prits./Fahrg.	59	09.91	08.94	FT80/100S/100L/115/120						
	2.5 TD Bus	63	10.92	07.94	FT80/100S/100L/115/120						
	2.5 TD Bus	74	09.91	07.94	FT80/100S/100L/115/120						
	2.5 TD Kasten	74	05.91	06.94	FT80/100S/100L/115/120						
	2.5 TD Prits./Fahrg.	63	11.92	08.94	FT80/100S/100L/115/120						
2.5 TD Prits./Fahrg.	74	09.91	08.94	FT80/100S/100L/115/120							
2.9 i Bus	107	01.91	08.94	FT80/100S/100L/115/120							
	2.0 Bus	66	09.91	09.94	FT130/150S/150L/190/190A/190EF	03.0137-0291.2	650291	+ Doppelbereifung ²⁾	280 x 65 Bremsbacken-Zubehör		
	2.0 i Bus	72	09.91	07.94	FT130/150S/150L/190/190A/190EF						
	2.0 i Kasten	72	09.91	06.94	FT130/150S/150L/190/190A/190EF						
	2.0 Kasten	66	09.91	06.94	FT130/150S/150L/190/190A/190EF						
	2.0 Pritsche/Fahrg.	72	09.91	08.94	FT130/150S/150L/190/190A/190EF						
	2.5 DI Bus	51	08.91	07.94	FT130/150S/150L/190/190A/190EF						
	2.5 DI Bus	59	09.91	07.94	FT130/150S/150L/190/190A/190EF						
	2.5 DI Kasten	51	05.91	06.94	FT130/150S/150L/190/190A/190EF						
	2.5 DI Kasten	59	05.91	06.94	FT130/150S/150L/190/190A/190EF						
	2.5 DI Kasten	63	10.92	06.94	FT130/150S/150L/190/190A/190EF						
	2.5 DI Prits./Fahrg.	51	09.91	08.94	FT130/150S/150L/190/190A/190EF						
	2.5 DI Prits./Fahrg.	59	09.91	08.94	FT130/150S/150L/190/190A/190EF						
	2.5 TD Bus	63	10.92	07.94	FT130/150S/150L/190/190A/190EF						
	2.5 TD Bus	74	09.91	07.94	FT130/150S/150L/190/190A/190EF						
	2.5 TD Kasten	74	05.91	06.94	FT130/150S/150L/190/190A/190EF						
	2.5 TD Prits./Fahrg.	63	11.92	08.94	FT130/150S/150L/190/190A/190EF						
2.5 TD Prits./Fahrg.	74	09.91	08.94	FT130/150S/150L/190/190A/190EF							
2.9 i Bus	107	01.91	08.94	FT130/150S/150L/190/190A/190EF							
	2.0 Bus	66	09.91	09.94	FT80/100S/100L/115/120	24.0225-4004.1	480069	+ Einfachbereifung ¹⁾	254/256 x 57,5		
	2.0 i Bus	72	09.91	07.94	FT80/100S/100L/115/120						
	2.0 i Kasten	72	09.91	06.94	FT80/100S/100L/115/120						
	2.0 Kasten	66	09.91	06.94	FT80/100S/100L/115/120						
	2.0 Pritsche/Fahrg.	72	09.91	08.94	FT80/100S/100L/115/120						
	2.5 DI Bus	51	08.91	07.94	FT80/100S/100L/115/120						
	2.5 DI Bus	59	09.91	07.94	FT80/100S/100L/115/120						
	2.5 DI Kasten	51	05.91	06.94	FT80/100S/100L/115/120						
	2.5 DI Kasten	59	05.91	06.94	FT80/100S/100L/115/120						
	2.5 DI Kasten	63	10.92	06.94	FT80/100S/100L/115/120						
	2.5 DI Prits./Fahrg.	51	09.91	08.94	FT80/100S/100L/115/120						
	2.5 DI Prits./Fahrg.	59	09.91	08.94	FT80/100S/100L/115/120						
	2.5 TD Bus	63	10.92	07.94	FT80/100S/100L/115/120						
	2.5 TD Bus	74	09.91	07.94	FT80/100S/100L/115/120						
	2.5 TD Kasten	74	05.91	06.94	FT80/100S/100L/115/120						
	2.5 TD Prits./Fahrg.	63	11.92	08.94	FT80/100S/100L/115/120						
2.5 TD Prits./Fahrg.	74	09.91	08.94	FT80/100S/100L/115/120							
2.9 i Bus	107	01.91	08.94	FT80/100S/100L/115/120							
	2.0 Bus	66	09.91	09.94	FT130/150S/150L/190/190A/190EF	24.0228-0001.1	480068	+ Doppelbereifung ²⁾	280/282 x 75,5		
	2.0 i Bus	72	09.91	07.94	FT130/150S/150L/190/190A/190EF						
	2.0 i Kasten	72	09.91	06.94	FT130/150S/150L/190/190A/190EF						
	2.0 Kasten	66	09.91	06.94	FT130/150S/150L/190/190A/190EF						
	2.0 Pritsche/Fahrg.	72	09.91	08.94	FT130/150S/150L/190/190A/190EF						
	2.5 DI Bus	51	08.91	07.94	FT130/150S/150L/190/190A/190EF						
	2.5 DI Bus	59	09.91	07.94	FT130/150S/150L/190/190A/190EF						
	2.5 DI Kasten	51	05.91	06.94	FT130/150S/150L/190/190A/190EF						
	2.5 DI Kasten	59	05.91	06.94	FT130/150S/150L/190/190A/190EF						
	2.5 DI Kasten	63	05.91	06.94	FT130/150S/150L/190/190A/190EF						

¹⁾ + single tyre / + ruota singola / + roue simple / + cubierta simple
²⁾ + twin tyres / + ruote gemellate / + roue jumelée / + cubierta doble

FORD TRANSIT (92-94)									
	2.5 DI Kasten 2.5 DI Prits./Fahrg. 2.5 DI Prits./Fahrg. 2.5 TD Bus 2.5 TD Bus 2.5 TD Kasten 2.5 TD Prits./Fahrg. 2.5 TD Prits./Fahrg. 2.9 i Bus	63 51 59 63 74 74 63 74 107	10.92 09.91 09.91 10.92 09.91 05.91 11.92 09.91 01.91	06.94 08.94 08.94 07.94 07.94 06.94 08.94 08.94 08.94	FT130/150S/150L/190/190A/190EF FT130/150S/150L/190/190A/190EF FT130/150S/150L/190/190A/190EF FT130/150S/150L/190/190A/190EF FT130/150S/150L/190/190A/190EF FT130/150S/150L/190/190A/190EF FT130/150S/150L/190/190A/190EF FT130/150S/150L/190/190A/190EF FT130/150S/150L/190/190A/190EF	24.0228-0001.1 480068		+ Doppelbereifung ¹⁾	280/282 x 75,5
	2.0 Bus 2.0 i Bus 2.0 i Kasten 2.0 Kasten 2.0 Pritsche/Fahrg. 2.5 DI Bus 2.5 DI Bus 2.5 DI Kasten 2.5 DI Kasten 2.5 DI Kasten 2.5 DI Prits./Fahrg. 2.5 DI Prits./Fahrg. 2.5 DI Prits./Fahrg. 2.5 TD Bus 2.5 TD Bus 2.5 TD Kasten 2.5 TD Prits./Fahrg. 2.5 TD Prits./Fahrg. 2.9 i Bus	66 72 72 66 72 51 59 51 59 63 51 59 63 74 74 74 63 74 107	09.91 09.91 09.91 09.91 09.91 08.91 09.91 05.91 05.91 10.92 09.91 09.91 10.92 09.91 05.91 11.92 09.91 01.91	09.94 07.94 06.94 06.94 08.94 07.94 07.94 06.94 06.94 06.94 08.94 08.94 07.94 07.94 06.94 08.94 08.94 08.94		24.3727-0636.2 24.3727-0637.2	580636 580637	1 ↕ + Einfachbereifung ²⁾ 1 ↕ + Doppelbereifung ¹⁾	L=2823 L=2730
	2.0 Bus 2.0 i Bus 2.0 i Kasten 2.0 Kasten 2.0 Pritsche/Fahrg. 2.5 DI Bus 2.5 DI Bus 2.5 DI Kasten 2.5 DI Kasten 2.5 DI Kasten 2.5 DI Prits./Fahrg. 2.5 DI Prits./Fahrg. 2.5 DI Prits./Fahrg. 2.5 TD Bus 2.5 TD Bus 2.5 TD Kasten 2.5 TD Prits./Fahrg. 2.5 TD Prits./Fahrg. 2.9 i Bus	66 72 72 66 72 51 59 51 59 63 51 59 63 74 74 74 63 74 107	09.91 09.91 09.91 09.91 09.91 08.91 09.91 05.91 05.91 10.92 09.91 09.91 10.92 09.91 05.91 11.92 09.91 01.91	09.94 07.94 06.94 06.94 08.94 07.94 07.94 06.94 06.94 06.94 08.94 08.94 07.94 07.94 06.94 08.94 08.94 08.94		24.3728-0627.2	590627		L=1376
GLAS GOGGOMOBIL (55-69)									
	T/TA/TS 300 T/TS 250 T/TS 400		02.55 02.57 05.57	04.67 12.69 05.60		03.3215-0221.3	020013		Rz 15,87
HANOMAG A-L 28									
	A-L 28		01.58	12.69	+ 1,5/ 2,5 t	03.3131-0102.3	010296		Hz 31,75 ATE
	A-L 28		01.58	12.69	+ 1,5/ 2,5 t	83.6103-0620.3	330234		L=620
HANOMAG F 20 - F 86									
	F 20 F 25/30/35 F 25/30/35 F 35 3-Achser F 35 Zugkopf F 45/46 Hydrair F 55 F 65/66 F 75/76 F 85 F 86		01.67 01.67 01.72 01.72 01.68 01.67 01.67 01.69	12.71 12.71 08.74 08.74 12.74 12.74 12.74 12.74	+ 2-Kreis-Bremse ³⁾ + Bremsgerät ⁴⁾ + Bremsgerät/ - (CD) ⁵⁾ + Bremsgerät ⁴⁾ + Bremsgerät ⁴⁾ + Radstand 3050mm ⁶⁾	03.2122-0704.3 03.3122-0101.3 03.2123-3302.3 03.2123-3302.3 03.3128-1401.3 03.0370-1828.2 03.3128-1401.3 03.0370-1828.2	010134 010277 010180 010180 010295 051828 010295 051828		THz 22,20 ATE Hz 22,20 ATE THz 23,81 ATE THz 23,81 ATE Hz 28,57 ATE Hz Reparaturatz Hz 28,57 ATE Hz Reparaturatz
	F 20 F 25/30/35 F 45/46 F 55/65/66 F 75/76 F 85 F 86		01.67 01.67 01.68 01.67 01.67 01.69	12.71 12.71 12.74 12.74 12.74 12.74	+ Bremsgerät ⁴⁾ + Bremsgerät ⁴⁾	83.6103-0200.3 83.6123-0471.3	330219 330263		L=200 L=470
	F 20 L/DL F 25 L/DL F 35 L/DL		01.73 01.73 01.73	08.74 08.74 08.74		24.3222-1733.3	020538		Rz 22,20

¹⁾ + twin tyres / + ruote gemellate / + roue jumelée / + cubierta doble

²⁾ + single tyre / + ruota singola / + roue simple / + cubierta simple



















³⁾ + two circuit brake / + impianto frenante doppio circuito / + frein à deux circuits / + freno de 2 circuitos

⁴⁾ + booster unit / + servofreno / + servo-frein / + servofreno













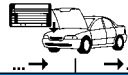



















⁵⁾ + booster unit/ - (CD) / + servofreno/ - (CD) / + servo-frein/ - (CD) / + servofreno/ - (CD)

⁶⁾ + wheel base 3050 mm / + passo 3050 mm / + empattement 3050 mm / + distancia entre ejes 3050 mm

⁷⁾ + MC 28,57 / + PF 28,57 / + MC 28,57 / + CM 28,57

HANOMAG F 20 - F 86											
	F 20 F 25/30/35			01.67 01.67	12.71 12.71	- Bremsgerät ¹⁾ - Bremsgerät ¹⁾	83.6203-0200.3	330298			L=200
	F 20 F 25/30/35 F 35 3-Achser			01.67 01.67 01.72	12.71 08.74 08.74	+ Bremsgerät ²⁾ + Bremsgerät ²⁾	83.6203-0200.3	330298			L=200
	F 20 F 25 F 30 F 35	6400229 6600417 6800096			08.74 08.74 08.74	+ ³⁾	03.3222-4401.3	020076			Rz 22,20
	F 20 L/DL F 25 L/DL F 35 L/DL			01.73 01.73 01.73	08.74 08.74 08.74		03.3222-4401.3	020076			Rz 22,20
	F 20/25/30/35			01.73	08.74		03.6521-0012.3	320094			BRL 2/1 (3) ATE
	F 20/25/30/35 F 35 Zugkopf			01.67 01.72	12.72 12.72		03.0450-2509.2	082509			Nz Reparatursatz
	F 20/25/30/35 F 35 Zugkopf			01.73 01.73	08.74 08.74		03.2525-2602.3 03.0450-2510.2	040029 082510			Nz 25,40 Nz Reparatursatz
HANOMAG GARANT											
	Garant/S			01.59	12.67		83.6123-0471.3	330263			L=470
HANOMAG KURIER											
	Kurier			01.58	12.67		83.6123-0471.3	330263			L=470
	Kurier Kurier Kastenw.			01.58 01.61	12.67 12.67	- Kastenwagen ³⁾	83.6103-0470.3 83.6103-0470.3 83.6203-0200.3	330229 330229 330298			L=470 L=470 L=200
HANOMAG MARKANT / ATHLET											
	Markant			01.60	12.67		83.6123-0471.3	330263			L=470
HANOMAG MATADOR											
	1.5			01.55	12.62	+ 1,3/ 1,5 t	83.6103-0350.3	330225			L=350
	1.5 1.6 1.6 1.6 1.6 E			01.55 01.63 01.64 01.64 01.66 01.66	12.62 12.68 12.68 12.65 12.68 12.68	+ 1,3/ 1,5 t + 1,0 t + 1,3 t + 1,6 t + 1,75 t + 1,5 t	83.6103-0200.3 83.6203-0200.3	330219 330298			L=200 L=200
	1.6			01.63	12.63	+ 1,3/ 1,6 t	03.3222-4401.3	020076			Rz 22,20
HENSCHEL F111 - F 261											
	F 130/A F 131/S			01.71 01.69	12.74 12.74		03.3508-0401.3	310014			Behälter
	F 130 F 131/S F 150/A			01.71 01.69 01.67	12.74 12.74 06.71	- F 130 A	83.6103-0600.3	330233			L=600
HENSCHEL HS 3 - HS 160											
	HS 120 T HS 90 HS 95/R			01.57 01.57 01.60	12.62 12.62 12.61		03.2419-1451.3	030012			Gz 19,05
	HS 14/15/16/18/19 HS 22 HS 3-125 T/TS HS 3-14			06.62 06.62 01.62 01.63	05.65 05.65 12.64 12.65		03.2522-2612.3	040012			Nz 22,20
	HS 120 T HS 14 HS 15 HS 16 HS 160-USL HS 18/19/20 HS 3-125 T/TS HS 3-14 HS 90 HS 95/R			01.57 01.60 06.62 01.60 01.62 06.62 01.62 01.63 01.57 01.60	12.62 03.64 03.64 03.64 12.64 03.64 12.64 12.65 12.62 12.61		83.6103-0320.3	330224			L=320

1) - booster unit / - servofreno / - servo-frein / - servofreno
2) + booster unit / + servofreno / + servo-frein / + servofreno
3) - Van / - furgone / - fourgonnette / - furgón







































									
HONDA ACCORD (81-85)									
	1.6 (AC) 1.8 (AD)		09.83 09.83	08.85 08.85	13.0460-5936.2 13.0460-0439.2	605936 610439		21012 15,0 Belagsatz-Zubehör	AKE AKE
	1.6 (AC) 1.8 (AD)		09.83 09.83	08.85 08.85	24.0119-0104.1	419104		242 19,0 17,0 V	
HONDA ACCORD (85-89)									
	1.6 (CA4) 2.0 i (CA5) 2.0 i Aero Deck (CA5)		09.85 09.85 09.85	12.89 08.87 08.87	13.0460-5918.2	605918		20099 15,0 +WK	AKE
	1.6 (CA4) 2.0 i (CA5) 2.0 i Aero Deck (CA5)		09.85 09.85 09.85	12.89 08.87 08.87	24.0119-0104.1	419104		242 19,0 17,0 V	
	2.0 i (CA5) 2.0 i 16V (CA5) 2.0 i Aero Deck (CA5)		09.87 12.86 09.87	12.89 12.89 12.89	24.0121-0102.1	421102		262 21,0 19,0 V	
	2.0 i (CA5) 2.0 i 16V (CA5) 2.0 i Aero Deck (CA5)		09.85 12.86 09.85	12.89 12.89 12.89	24.0101-3004.2	260042		Bremssattel-Zubehör	LUC
	2.0 i (CA5) 2.0 i 16V (CA5) 2.0 i Aero Deck (CA5)		09.85 12.86 09.85	12.89 12.89 12.89	13.0460-5998.2 13.0460-0430.2	605998 610430		21312 12,8 +WK Belagsatz-Zubehör	AKE AKE
	2.0 i (CA5) 2.0 i 16V (CA5) 2.0 i Aero Deck (CA5)		09.85 12.86 09.85	12.89 12.89 12.89	24.0110-0212.1	410212		239 10,0 8,0 +S +B	
	1.6 (CA4) 2.0 i (CA5) 2.0 i Aero Deck (CA5)		09.85 09.85 09.85	12.89 - ABS 12.89	03.0137-0294.2 03.0137-9097.2	650294 669097		200 x 36 Bremsbacken-Zubehör	
HONDA ACCORD (90-93)									
	2.0 i 16V (CB3) 2.0 i 16V Coupe (CC1) 2.0 i Aero Deck (CC9) 2.2 i Aero Deck (CB8)		01.90 01.92 01.93 01.91	12.93 12.93 12.93 12.93	13.0460-5818.2 13.0460-5982.2 13.0460-0075.2	605818 605982 610075		21497 18,0 +WK Belagsatz-Zubehör	AKE
	2.0 i 16V (CB3) 2.0 i 16V Coupe (CC1) 2.2 i 16V (CB7)		01.90 01.92 01.90	12.93 + 14" Rad 1) 12.93 + 14" Rad 1) 12.93 + 15" Rad 2)	24.0123-0103.1	423103		260 23,0 21,0 V	
	2.0 i Aero Deck (CC9) 2.2 i Aero Deck (CB8)		01.93 01.91	12.93 12.93	24.0123-0102.1 24.0125-0130.1	423102 425130		282 23,0 21,0 V 282 25,0 23,0 V	
	2.0 i 16V (CB3) 2.0 i 16V Coupe (CC1) 2.0 i Aero Deck (CC9) 2.2 i 16V (CB7) 2.2 i Aero Deck (CB8)		01.90 01.92 01.93 01.90 01.91	12.93 + ABS 12.93 12.93 12.93 12.93	13.0460-5929.2 13.0460-0287.2	605929 610287		21719 15,0 +WK Belagsatz-Zubehör	AKE
	2.0 i 16V (CB3) 2.0 i 16V Coupe (CC1) 2.0 i Aero Deck (CC9) 2.2 i 16V (CB7) 2.2 i Aero Deck (CB8) 2.2 i 16V 4WD (CB7)		01.90 01.92 01.93 01.90 01.91 01.90	12.93 + ABS 12.93 12.93 12.93 12.93 12.93	24.0110-0233.1	410233		260 10,0 8,0 +S +B	
	2.0 i 16V (CB3)		01.90	12.93 - ABS	24.0110-0267.1 24.3219-1723.3 24.3219-1724.3	410267 020427 020428	 	260 10,0 8,0 Rz 19,05 Rz 19,05	
	2.0 i 16V (CB3)		01.90	12.93 - ABS	03.0137-0287.2 03.0137-9190.2	650287 669190		220 x 36 Bremsbacken-Zubehör	
	2.0 i 16V (CB3)		01.90	12.93 - ABS	24.0222-0001.1	480123		220/221 x 44,5	
HONDA ACURA INTEGRA (84-90)									
	1.5 1.6		05.86 05.86	05.90 + Europa 3) 05.90 + Europa 3)	13.0460-5918.2	605918		20099 15,0 +WK	AKE
	1.6 1.5 1.6		02.84 05.86 05.86	04.86 + (USA) / + Europa 4) 05.90 + (USA) / + Europa 4) 05.90 + (USA) / + Europa 4)	24.0117-0101.1 24.0119-0106.1	417101 419106		231 17,0 15,0 V 242 19,0 17,0 V	AKE
	1.5 1.6		05.86 05.86	05.90 + Europa 3) 05.90 + Europa 3)	03.0137-9097.2	669097		Bremsbacken-Zubehör	
HONDA BALLADE (GB) (86-91)									
	1.5 (HJ)		02.86	08.91	24.0117-0101.1	417101		231 17,0 15,0 V	AKE
	1.5 (HJ)		02.86	08.91	03.0137-0179.2 03.0137-9096.2	650179 669096		180 x 31 Bremsbacken-Zubehör	









































1) + 14" wheel / + ruota 14" / + roue 14" / + rueda 14"































2) + 15" wheel / + ruota 15" / + roue 15" / + rueda 15"

3) + Europe / + Europa / + Europe / + Europa





































4) + (USA) / + Europe / + (USA) / + Europa / + (USA) / + Europe / + (USA) / + Europa

										
HONDA CONCERTO (90-95)										
	1.4 (HW) 1.5 i (HW) 1.6 i 16V (HW) 1.6 i 16V (HW)	66 66 82 90		08.89 01.90 01.90 01.90	01.95 01.95 01.95 01.95	24.3541-1813.5 24.3541-1814.5	240381 240382	 	D=54, - Halter D=54, - Halter	LUC LUC
	1.4 (HW) 1.5 i (HW) 1.6 i 16V (HW) 1.6 i 16V (HW)	66 66 82 90		08.89 01.90 01.90 01.90	01.95 01.95 01.95 01.95	13.0460-5920.2 13.0460-0308.2	605920 610308		21322 15,0 +/WK Belagsatz-Zubehör	AKE AKE
	1.4 (HW) 1.5 i (HW) 1.6 i 16V (HW) 1.6 i 16V (HW)	66 66 82 90		08.89 01.90 01.90 01.90	01.95 01.95 01.95 01.95	24.0121-0107.1	421107		262 21,0 19,0 V	
	1.6 i 16V (HW) 1.6 i 16V (HW)	82 90		01.90 01.90	01.95 01.95	24.3304-1701.5 24.3304-1702.5	240113 240114	 	D=30, - Halter D=30, - Halter	LUC LUC
	1.6 i 16V (HW) 1.6 i 16V (HW)	82 90		01.90 01.90	01.95 01.95	13.0460-5998.2 13.0460-0430.2	605998 610430		21312 12,8 +/WK Belagsatz-Zubehör	AKE AKE
	1.6 i 16V (HW) 1.6 i 16V (HW)	82 90		01.90 01.90	01.95 01.95	24.0110-0212.1	410212		239 10,0 8,0 +S +B	
	1.4 (HW) 1.5 i (HW)	66 66		08.89 01.90	01.95 01.95	24.3219-1710.3	020386		Rz 19,05	
	1.4 (HW) 1.5 i (HW)	66 66		08.89 01.90	01.95 01.95	03.0137-0339.2 03.0137-9221.2	650339 669221		203 x 38 Bremsbacken-Zubehör	
	1.4 (HW) 1.5 i (HW)	66 66		08.89 01.90	01.95 01.95	24.0220-3016.1	480107		203/204 x 45,5	
	1.4 (HW) 1.5 i (HW)	66 66		08.89 01.90	01.95 01.95	03.0420-3719.3	683719		19,05/203x38 Kit	LUC
HONDA CIVIC (79-83)										
	1.3 (SL) 1.3 (SL) 1.3 (SS)	33 44 44		09.79 09.79 09.79	08.83 08.83 08.83	13.0460-5916.2	605916		20731 15,3	AKE
	1.3 (SL) 1.3 (SL) 1.3 (SS) 1.3 S (SL)	33 44 44 52		01.82 01.82 01.82 01.82	08.83 08.83 08.83 08.83	24.3219-1121.3 24.3219-1122.3	020363 020364	 	Rz 19,05 Rz 19,05	
HONDA CIVIC (83-87)										
	1.2 (AL) 1.3 (AG) 1.5 (AH) 1.5 GTI (AH) 1.5 i (AH)	 63 66 74		09.83 09.83 09.83 09.83 01.85	08.87 08.87 08.87 08.87 08.87	24.0112-0102.1	412102		231 12,0 10,0	
	1.2 (AL) 1.3 (AG) 1.5 (AH) 1.5 GTI (AH) 1.5 i (AH)	 63 66 74		09.83 09.83 09.83 09.83 01.85	08.87 08.87 08.87 08.87 08.87	24.3219-1121.3 24.3219-1122.3	020363 020364	 	Rz 19,05 Rz 19,05	
	1.2 (AL) 1.3 (AG) 1.5 (AH) 1.5 GTI (AH) 1.5 i (AH)	 63 66 74		09.83 09.83 09.83 09.83 01.85	08.87 08.87 08.87 08.87 08.87	03.0137-0179.2 03.0137-9096.2	650179 669096		180 x 31 Bremsbacken-Zubehör	
	1.2 (AL) 1.3 (AG) 1.5 (AH) 1.5 GTI (AH) 1.5 i (AH)	 63 66 74		09.83 09.83 09.83 09.83 01.85	08.87 08.87 08.87 08.87 08.87	24.0218-0018.1	480063		180/181 x 38	
HONDA CIVIC (3-tuerig) (87-91)										
	1.3 (EC8) 1.4 (EC9) 1.5 i 16V (ED6) 1.6 i 16V (ED7)	 63 66		09.87 09.87 09.89 09.87	08.91 12.89 08.91 08.91	13.0460-5919.2 13.0460-5920.2	605919 605920		20959 15,0 +/WK Belagsatz-Zubehör	AKE AKE
	1.3 (EC8) 1.4 (EC9) 1.5 i 16V (ED6) 1.6 i 16V (ED7)	 63 66		09.87 09.87 09.89 09.87	08.91 12.89 08.91 08.91	24.0112-0102.1 24.0117-0101.1	412102 417101		231 12,0 10,0 231 17,0 15,0 V	AKE AKE
	1.6 i 16V VTEC (EE9) 1.6 i 16V (ED7) 1.6 i 16V VTEC (EE9)	 66 66		06.90 09.87 06.90	08.91 08.91 08.91	24.0121-0105.1 24.0101-3004.2	421105 260042		262 21,0 19,0 V +S +B Bremsattel-Zubehör	LUC LUC
	1.6 i 16V (ED7) 1.6 i 16V VTEC (EE9)	 66		09.87 06.90	08.91 08.91	13.0460-5998.2 13.0460-0430.2	605998 610430		21312 12,8 +/WK Belagsatz-Zubehör	AKE AKE

								
HONDA CIVIC (3-tuerig) (87-91)								
	1.6 i 16V (ED7) 1.6 i 16V VTEC (EE9)		09.87 06.90	08.91 08.91	24.0110-0212.1	410212		239 10,0 8,0 +S +B
	1.3 (EC8) 1.4 (EC9) 1.5 i 16V (ED6)		09.87 09.87 09.89	12.89 12.89 08.91	24.3219-1121.3 24.3219-1122.3	020363 020364	 	Rz 19,05 Rz 19,05
	1.3 (EC8) 1.4 (EC9)		01.90 01.90	08.91 08.91	24.3219-1723.3 24.3219-1724.3	020427 020428	 	Rz 19,05 Rz 19,05
	1.3 (EC8) 1.4 (EC9) 1.5 i 16V (ED6)		09.87 09.87 09.89	08.91 12.89 08.91	03.0137-0179.2 03.0137-9096.2	650179 669096		180 x 31 Bremsbacken-Zubehör
	1.3 (EC8) 1.4 (EC9) 1.5 i 16V (ED6)		09.87 09.87 09.89	08.91 12.89 08.91	24.0218-0018.1	480063		180/181 x 38
HONDA CIVIC (4-tuerig) (87-91)								
	1.4 (ED2) 1.5 i 16V (ED3) 1.6 i 16V (ED4) 1.6 i 16V 4x4 (ED4)		09.87 09.89 09.87 09.87	12.89 08.91 08.91 08.91	13.0460-5919.2 13.0460-5920.2 13.0460-0308.2	605919 605920 610308		20959 15,0 +/WK AKE 21322 15,0 +/WK AKE Belagsatz-Zubehör AKE
	1.4 (ED2) 1.5 i 16V (ED3) 1.6 i 16V (ED4) 1.6 i 16V 4x4 (ED4)		09.87 09.89 09.87 09.87	12.89 08.91 08.91 08.91	24.0117-0101.1 24.0119-0106.1	417101 419106		231 17,0 15,0 V AKE 242 19,0 17,0 V
	1.6 i 16V (ED4) 1.6 i 16V 4x4 (ED4)		09.87 09.87	08.91 08.91	24.0101-3004.2	260042		Bremssattel-Zubehör LUC
	1.6 i 16V (ED4) 1.6 i 16V 4x4 (ED4)		09.87 09.87	08.91 08.91	13.0460-5998.2 13.0460-0430.2	605998 610430		21312 12,8 +/WK AKE Belagsatz-Zubehör AKE
	1.6 i 16V (ED4) 1.6 i 16V 4x4 (ED4)		09.87 09.87	08.91 08.91	24.0110-0212.1	410212		239 10,0 8,0 +S +B
	1.4 (ED2) 1.5 i 16V (ED3)		09.87 09.89	12.89 08.91	24.3219-1121.3 24.3219-1122.3	020363 020364	 	Rz 19,05 Rz 19,05
	1.4 (ED2) 1.5 i 16V (ED3)		09.87 09.89	12.89 08.91	03.0137-0179.2 03.0137-9096.2	650179 669096		180 x 31 Bremsbacken-Zubehör
	1.4 (ED2) 1.5 i 16V (ED3)		09.87 09.89	12.89 08.91	24.0218-0018.1	480063		180/181 x 38
HONDA CIVIC (3-tuerig) (91-95)								
	1.3 16V (EG3) 1.3 16V (EG3) 1.5 16V (EG4) 1.6 16V VTEC (EG5)	92	09.91 09.91 09.91 09.91	10.95 10.95 10.95 - ABS	13.0460-5919.2 13.0460-5943.2	605919 605943		20959 15,0 +/WK AKE 21697 15,0 +/WK SUM
	1.6 16V VTEC (EG5) 1.6 16V VTEC (EG6)	92 118	09.91 09.91	10.95 + ABS 10.95	13.0460-5820.2	605820		21694 16,3 +/WK SUM
	1.3 16V (EG3) 1.3 16V (EG3) 1.5 16V (EG4) 1.6 16V VTEC (EG5)	92	09.91 09.91 09.91 09.91	10.95 10.95 10.95 - ABS	24.0117-0101.1 24.0121-0104.1	417101 421104		231 17,0 15,0 V AKE 240 21,0 19,0 V +S +B SUM
	1.6 16V VTEC (EG5) 1.6 16V VTEC (EG6)	92 118	09.91 09.91	10.95 + ABS 10.95	24.0121-0105.1	421105		262 21,0 19,0 V +S +B
	1.6 16V VTEC (EG5) 1.6 16V VTEC (EG6)	92 118	09.91 09.91	10.95 10.95	13.0460-5998.2 13.0460-0430.2	605998 610430		21312 12,8 +/WK AKE Belagsatz-Zubehör AKE
	1.6 16V VTEC (EG5) 1.6 16V VTEC (EG6)	92 118	09.91 09.91	10.95 10.95	24.0109-0111.1	409111		239 9,0 8,0 +S +B
	1.3 16V (EG3) 1.5 16V (EG4)		09.91 09.91	10.95 10.95	24.3219-1723.3 24.3219-1724.3	020427 020428	 	Rz 19,05 Rz 19,05
	1.3 16V (EG3) 1.5 16V (EG4)		09.91 09.91	10.95 10.95	03.0137-0284.2 03.0137-9096.2	650284 669096		180 x 31 Bremsbacken-Zubehör
	1.3 16V (EG3) 1.5 16V (EG4)		09.91 09.91	10.95 10.95	24.0218-0018.1	480063		180/181 x 38
HONDA CIVIC (4-tuerig) (91-95)								
	1.5 16V (EG8) 1.6 16V VTEC (EH9)	92	09.91 09.91	10.95 - ABS	13.0460-5943.2	605943		21697 15,0 +/WK SUM
	1.6 16V 4WD VTEC(EH1) 1.6 16V VTEC (EG9) 1.6 16V VTEC (EH9)	92 118 92	09.91 09.91 09.91	10.95 10.95 + ABS	13.0460-5820.2	605820		21694 16,3 +/WK SUM





























								
HONDA CIVIC (4-tuerig) (91-95)								
	1.5 16V (EG8) 1.6 16V VTEC (EH9)	92	09.91 09.91	10.95 10.95	- ABS	24.0121-0104.1	421104	240 21,0 19,0 V +S +B SUM
	1.6 16V 4WD VTEC(EH1) 1.6 16V VTEC (EG9) 1.6 16V VTEC (EH9)	92 118 92	09.91 09.91 09.91	10.95 10.95 10.95	+ ABS	24.0121-0105.1	421105	262 21,0 19,0 V +S +B
	1.6 16V VTEC (EG9) 1.6 16V VTEC (EH9)	118 92	09.91 09.91	10.95 10.95		13.0460-5998.2 13.0460-0430.2	605998 610430	21312 12,8 +/WK AKE Belagsatz-Zubehör AKE
	1.6 16V VTEC (EG9) 1.6 16V VTEC (EH9)	118 92	09.91 09.91	10.95 10.95		24.0109-0111.1	409111	239 9,0 8,0 +S +B
	1.5 16V (EG8) 1.6 16V 4WD VTEC(EH1)	92	09.91 09.91	10.95 10.95		24.3219-1723.3 24.3219-1724.3	020427 020428	Rz 19,05 Rz 19,05
	1.5 16V (EG8) 1.6 16V 4WD VTEC(EH1)	92	09.91 09.91	10.95 10.95		03.0137-0294.2 03.0137-9097.2	650294 669097	200 x 36 Bremsbacken-Zubehör
HONDA CIVIC (5-tuerig) (94-96)								
	1.4 i (MA8) 1.5 VTEC E (MA9) 1.6 i (MB1) 1.6 VTEC (MB1)		09.94 09.94 09.94 09.94	12.96 12.96 12.96 12.96		24.3541-1813.5 24.3541-1814.5	240381 240382	D=54, - Halter LUC D=54, - Halter LUC
	1.4 i (MA8) 1.5 VTEC E (MA9) 1.6 i (MB1) 1.6 VTEC (MB1)		09.94 09.94 09.94 09.94	12.96 12.96 12.96 12.96		13.0460-5920.2 13.0460-0308.2 13.0460-2803.2 13.0460-0142.2	605920 610308 602803 610142	21322 15,0 +/WK AKE Belagsatz-Zubehör AKE 21515 17,5 +/WK/S LUC Belagsatz-Zubehör
	1.4 i (MA8) 1.5 VTEC E (MA9) 1.6 i (MB1) 1.6 VTEC (MB1)		09.94 09.94 09.94 09.94	12.96 12.96 12.96 12.96		24.0121-0105.1	421105	262 21,0 19,0 V +S +B
	1.4 i (MA8) 1.5 VTEC E (MA9) 1.6 i (MB1) 1.6 VTEC (MB1)		09.94 09.94 09.94 09.94	12.96 12.96 12.96 12.96	+ ABS + ABS	24.3304-1701.5 24.3304-1702.5 24.0101-3004.2	240113 240114 260042	D=30, - Halter LUC D=30, - Halter LUC Bremsattel-Zubehör LUC
	1.4 i (MA8) 1.5 VTEC E (MA9) 1.6 i (MB1) 1.6 VTEC (MB1)		09.94 09.94 09.94 09.94	12.96 12.96 12.96 12.96	+ ABS + ABS	13.0460-5998.2 13.0460-0430.2	605998 610430	21312 12,8 +/WK AKE Belagsatz-Zubehör AKE
	1.4 i (MA8) 1.5 VTEC E (MA9) 1.6 i (MB1) 1.6 VTEC (MB1)		09.94 09.94 09.94 09.94	12.96 12.96 12.96 12.96	+ ABS + ABS	24.0110-0212.1	410212	239 10,0 8,0 +S +B
	1.4 i (MA8) 1.5 VTEC E (MA9)		09.94 09.94	12.95 12.95	- ABS - ABS	24.3219-1710.3	020386	Rz 19,05
	1.4 i (MA8) 1.5 VTEC E (MA9)		01.96 01.96	12.96 12.96	- ABS - ABS	24.3219-1743.3	020485	Rz 19,05
	1.4 i (MA8) 1.5 VTEC E (MA9)		09.94 09.94	12.95 12.95	- ABS - ABS	03.0137-0339.2 03.0137-9221.2	650339 669221	203 x 38 Bremsbacken-Zubehör
	1.4 i (MA8) 1.5 VTEC E (MA9)		01.96 01.96	12.96 12.96	- ABS - ABS	03.0137-0339.2	650339	203 x 38
	1.4 i (MA8) 1.5 VTEC E (MA9)		09.94 09.94	12.96 12.96	- ABS - ABS	24.0220-3016.1	480107	203/204 x 45,5
	1.4 i (MA8) 1.5 VTEC E (MA9)		09.94 09.94	12.95 12.95	- ABS - ABS	03.0420-3719.3	683719	19,05/203x38 Kit LUC
	1.4 i (MA8) 1.5 VTEC E (MA9)		01.96 01.96	12.96 12.96	- ABS - ABS	03.0420-4519.3	684519	19,05/203x38 Kit
HONDA CIVIC COUPE (94-95)								
	1.6 i (EJ6)	77	01.94	12.95	- ABS	24.2120-1751.3	010909	THz 20,64
	1.5 i (EJ2) 1.6 i (EJ6) 1.6 VTEC (EJ1)	74 77 92	01.94 01.94 01.94	12.95 12.95 12.95		13.0460-5943.2 13.0460-0073.2 13.0460-5820.2 13.0460-0073.2	605943 610073 605820 610073	21697 15,0 +/WK SUM Belagsatz-Zubehör 21694 16,3 +/WK SUM Belagsatz-Zubehör
	1.5 i (EJ2) 1.6 i (EJ6) 1.6 VTEC (EJ1)	74 77 92	01.94 01.94 01.94	12.95 12.95 12.95		24.0121-0104.1	421104	240 21,0 19,0 V +S +B SUM
	1.5 i (EJ2) 1.6 i (EJ6) 1.6 VTEC (EJ1)	74 77 92	01.94 01.94 01.94	12.95 12.95 12.95		24.3219-1723.3 24.3219-1724.3	020427 020428	Rz 19,05 Rz 19,05
	1.5 i (EJ2) 1.6 i (EJ6) 1.6 VTEC (EJ1)	74 77 92	01.94 01.94 01.94	12.95 12.95 12.95		03.0137-0294.2 03.0137-9097.2	650294 669097	200 x 36 Bremsbacken-Zubehör
HONDA CIVIC SHUTTLE (83-87)								
	1.5 (AN)		09.83	08.87	- (CB)	13.0460-5919.2	605919	20959 15,0 +/WK AKE

KW		
HONDA CIVIC SHUTTLE (83-87)															
	1.5 (AN)			09.83	08.87	- CH		24.0112-0102.1	412102					231 12,0 10,0	
	1.5 (AN)			09.83	08.87	+ CH		24.0117-0101.1	417101					231 17,0 15,0 V	AKE
	1.5 4WD (AR)			01.85	08.87										
	1.5 (AN)			09.83	08.87			24.3219-1121.3	020363					Rz 19,05	
	1.5 4WD (AR)			01.85	08.87			24.3219-1122.3	020364					Rz 19,05	
	1.5 (AN)			09.83	08.87			03.0137-9097.2	669097					Bremsbacken-Zubehör	
	1.5 4WD (AR)			01.85	08.87										
HONDA CIVIC SHUTTLE (87-91)															
	1.4 (EE1)			09.87	12.89			13.0460-5920.2	605920					21322 15,0 +/WK	AKE
	1.6 i 16V 4WD (EE4)			09.87	08.91			13.0460-0308.2	610308					Belagsatz-Zubehör	AKE
	1.4 (EE1)			09.87	12.89			24.0119-0106.1	419106					242 19,0 17,0 V	
	1.5 16V (EE2)			09.87	12.89										
	1.6 i 16V 4WD (EE4)			09.87	08.91										
	1.4 (EE1)			09.87	12.89			03.0137-9097.2	669097					Bremsbacken-Zubehör	
	1.6 i 16V 4WD (EE4)			09.87	08.91										
HONDA CRX (83-87)															
	1.5 (AF)	74		01.86	08.87	- D		13.0460-5919.2	605919					20959 15,0 +/WK	AKE
	1.6 i 16V (AS)	92		12.86	08.87			13.0460-5918.2	605918					20099 15,0 +/WK	AKE
	1.5 (AF)	74		09.83	12.85	+ D		24.0117-0101.1	417101					231 17,0 15,0 V	AKE
	1.5 (AF)	74		01.86	08.87	- D		24.0112-0102.1	412102					231 12,0 10,0	
	1.6 i 16V (AS)	92		12.86	08.87			24.0119-0106.1	419106					242 19,0 17,0 V	
	1.5 (AF)	74		09.83	08.87			03.0137-0179.2	650179					180 x 31	
	1.6 i 16V (AS)	92		12.86	08.87			03.0137-9096.2	669096					Bremsbacken-Zubehör	
	1.5 (AF)	74		09.83	08.87			24.0218-0018.1	480063					180/181 x 38	
	1.6 i 16V (AS)	92		12.86	08.87										
HONDA CRX (87-91)															
	1.6 i 16V (ED9)			09.87	08.91			13.0460-5920.2	605920					21322 15,0 +/WK	AKE
	1.6 i 16V (ED9)			09.87	08.91			13.0460-0308.2	610308					Belagsatz-Zubehör	AKE
	1.6 i 16V (ED9)			09.87	08.91			24.0119-0106.1	419106					242 19,0 17,0 V	
	1.6 i 16V VTEC (EE8)			06.90	08.91			24.0121-0105.1	421105					262 21,0 19,0 V +S +B	
	1.6 i 16V (ED9)			09.87	08.91			24.0101-3004.2	260042					Bremssattel-Zubehör	LUC
	1.6 i 16V VTEC (EE8)			06.90	08.91										
	1.6 i 16V (ED9)			09.87	08.91			13.0460-5998.2	605998					21312 12,8 +/WK	AKE
	1.6 i 16V VTEC (EE8)			06.90	08.91			13.0460-0430.2	610430					Belagsatz-Zubehör	AKE
	1.6 i 16V (ED9)			09.87	08.91			24.0110-0212.1	410212					239 10,0 8,0 +S +B	
	1.6 i 16V VTEC (EE8)			06.90	08.91										
HONDA LEGEND (86-88)															
	2.5 i (HS)			08.86	08.87			24.0121-0100.1	421100					285 21,0 19,0 V	
	2.7 i (HS)			09.87	08.88										
	2.5 i (HS)			08.86	08.87			13.0460-2800.2	602800					20087 14,6 +/WK	LUC
	2.7 i (HS)			09.87	08.88										
	2.5 i (HS)			08.86	08.87			24.0110-0255.1	410255					260 10,0 8,0	
	2.7 i (HS)			09.87	08.88										
HONDA LEGEND (91-96)															
	3.2 i 24V (KA7)	151		01.91	01.96			13.0460-5982.2	605982					21651 17,5 +/WK	
	3.2 i 24V Coupe (KA8)	151		01.91	01.96										
	3.2 i 24V (KA7)	151		01.91	01.96			24.0128-0722.1	428722					282 28,0 26,0 V	
	3.2 i 24V Coupe (KA8)	151		01.91	01.96										
	3.2 i 24V (KA7)	151		01.91	01.96			13.0460-5711.2	605711					23652 15,7 +/WK	
	3.2 i 24V Coupe (KA8)	151		01.91	01.96										
	3.2 i 24V (KA7)	151		01.91	01.96			24.0109-0132.1	409132					282 9,0 7,5	
	3.2 i 24V Coupe (KA8)	151		01.91	01.96										

								
HONDA PRELUDE (83-87)								
	1.8 (AB)		03.83	08.87	13.0460-5919.2	605919		20959 15,0 +/WK AKE
	2.0 i 16V (BA2)		09.85	08.87	24.0121-0102.1	421102		262 21,0 19,0 V
	2.0 i 16V (BA2)		09.85	08.87	13.0460-5998.2	605998		21312 12,8 +/WK AKE
					13.0460-0430.2	610430		Belagsatz-Zubehör AKE
HONDA PRELUDE (87-91)								
	2.0 (BA4)	80	09.87	12.91	13.0460-5920.2	605920		21322 15,0 +/WK AKE
					13.0460-0308.2	610308		Belagsatz-Zubehör AKE
	2.0 (BA4)	80	09.87	12.91	24.0119-0104.1	419104		242 19,0 17,0 V
	2.0 i 16V (BA4)	101	09.87	12.91	24.0121-0102.1	421102		262 21,0 19,0 V
	2.0 i 16V (BA4)	103	09.87	12.91				
	2.0 (BA4)	80	09.87	12.91	13.0460-5998.2	605998		21312 12,8 +/WK AKE
	2.0 i 16V (BA4)	101	09.87	12.91	13.0460-0430.2	610430		Belagsatz-Zubehör AKE
	2.0 i 16V (BA4)	103	09.87	12.91				
	2.0 (BA4)	80	09.87	12.91	24.0110-0212.1	410212		239 10,0 8,0 +S +B
	2.0 i 16V (BA4)	101	09.87	12.91				
	2.0 i 16V (BA4)	103	09.87	12.91				
HONDA PRELUDE (92-96)								
	2.0 i 16V (BB3)	98	01.92	12.96 + 14" Rad ¹⁾	13.0460-5955.2	605955		21879 18,6 +/WK AKE
					13.0460-0453.2	610453		Belagsatz-Zubehör AKE
	2.2 i 16V VTEC (BB1)	136	01.93	12.96 + 15" Rad ²⁾	13.0460-5982.2	605982		21651 17,5 +/WK
	2.3 i 16V (BB2)	118	01.92	12.96 + 15" Rad ²⁾				
	2.0 i 16V (BB3)	98	01.92	12.96 + 14" Rad ¹⁾	24.0123-0105.1	423105		260 23,0 21,0 V
	2.2 i 16V VTEC (BB1)	136	01.93	12.96 + 15" Rad ²⁾	24.0123-0106.1	423106		282 23,0 21,0 V
	2.3 i 16V (BB2)	118	01.92	12.96 + 15" Rad ²⁾				
	2.0 i 16V (BB3)	98	01.92	12.96	13.0460-5929.2	605929		21719 15,0 +/WK AKE
	2.2 i 16V VTEC (BB1)	136	01.93	12.96				
	2.3 i 16V (BB2)	118	01.92	12.96				
	2.0 i 16V (BB3)	98	01.92	12.96	24.0110-0267.1	410267		260 10,0 8,0
	2.2 i 16V VTEC (BB1)	136	01.93	12.96				
	2.3 i 16V (BB2)	118	01.92	12.96				
HONDA QUINTET (80-83)								
	1.6 (SU)	59	09.80	06.83	24.3219-1121.3	020363		Rz 19,05
					24.3219-1122.3	020364		Rz 19,05
HYUNDAI LANTRA/ELANTRA (90-95)								
	1.5		12.90	04.95	24.3541-1807.5	240335		D=54, - Halter AKE
					24.3541-1808.5	240336		D=54, - Halter AKE
	1.5		12.90	04.95	13.0460-5936.2	605936		21012 15,0 AKE
					13.0460-0439.2	610439		Belagsatz-Zubehör AKE
	1.6 16V		12.90	04.95	13.0460-5933.2	605933		21725 16,8 +/WK AKE
	1.8 16V		12.90	04.95				
	1.5		12.90	04.95	24.0119-0111.1	419111		242 19,2 17,0 V
	1.6 16V		12.90	04.95	24.0122-0170.1	422170		257 22,0 20,0 V
	1.8 16V		12.90	04.95	24.0322-0170.1	522170		257 22,0 20,0 V PD
	1.5		12.90	04.95 - ABS	03.0137-0369.2	650369		203 x 39 HEB
	1.6 16V		12.90	04.95 - ABS	03.0137-9270.2	669270		Bremsbacken-Zubehör
	1.8 16V		12.90	04.95 - ABS				
HYUNDAI PONY/EXCEL (89-94)								
	1.3		08.89	06.94	24.3541-1807.5	240335		D=54, - Halter AKE
	1.5		08.89	06.94	24.3541-1808.5	240336		D=54, - Halter AKE
	1.3		08.89	06.94	13.0460-5936.2	605936		21012 15,0 AKE
	1.5		08.89	06.94	13.0460-0439.2	610439		Belagsatz-Zubehör AKE
	1.3		08.89	06.94	24.0119-0109.1	419109		242 19,1 17,0 V
	1.5		08.89	06.94				
	1.3		06.90	06.94	03.0137-0367.2	650367		180 x 37 HEB
	1.5		06.90	06.94	03.0137-9277.2	669277		Bremsbacken-Zubehör
HYUNDAI PONY/EXCEL (94-95)								
	1.3		07.94	12.95	13.0460-5936.2	605936		21012 15,0 AKE
	1.5		07.94	12.95				
	1.3		07.94	12.95	24.0119-0109.1	419109		242 19,1 17,0 V
	1.5		07.94	12.95				



























¹⁾ + 14" wheel / + ruota 14" / + roue 14" / + rueda 14"

²⁾ + 15" wheel / + ruota 15" / + roue 15" / + rueda 15"

								
HYUNDAI PONY/EXCEL (94-95)								
	1.3 1.5			07.94 07.94	12.95 12.95	03.0137-0366.2 03.0137-9277.2	650366 669277	180 x 32 HEB Bremsbacken-Zubehör
	1.3 1.5			07.94 07.94	12.95 12.95	24.0218-0027.1	480099	180/182 x 44
	1.3 1.5			07.94 07.94	12.95 12.95	24.3727-3103.2 24.3727-3102.2	583103 583102	L=1485 L=1485
HYUNDAI SONATA (88-93)								
	1.8 2.0 2.4 3.0 i V6	95 83 107		10.88 10.88 10.88 09.90	04.93 04.93 04.93 04.93	13.0460-5933.2	605933	21725 16,8 +/WK AKE
	1.8 2.0 2.4 3.0 i V6	95 83 107		10.88 10.88 10.88 09.90	04.93 04.93 04.93 04.93	24.0122-0169.1	422169	257 22,0 20,0 V
HYUNDAI S-COUPE (90-96)								
	1.5 (G4DJ) 1.5 (G4EK) 1.5 i Turbo	62 65 85		03.90 06.92 04.91	05.92 04.96 05.96	24.3541-1807.5 24.3541-1808.5	240335 240336	D=54, - Halter D=54, - Halter AKE AKE
	1.5 (G4EK) 1.5 i Turbo	65 85		06.92 06.92	04.96 05.96	13.0460-5936.2 13.0460-0439.2	605936 610439	21012 15,0 Belagsatz-Zubehör AKE AKE
	1.5 (G4DJ) 1.5 (G4EK) 1.5 i Turbo	62 65 85		03.90 06.92 04.91	05.92 04.96 05.96	24.0119-0109.1	419109	242 19,1 17,0 V
	1.5 (G4EK) 1.5 i Turbo	65 85		06.92 06.92	04.96 05.96	03.0137-0367.2 03.0137-9277.2	650367 669277	180 x 37 HEB Bremsbacken-Zubehör
HYUNDAI STELLAR (84-90)								
	1.4 1.6 1.6	50 56 56		02.84 02.84 06.86	01.87 - ABS 05.86 02.90	13.0460-7042.2	607042	20491 15,0 LUC
	1.4 1.6	50 56		02.84 02.84	01.87 - ABS 02.90	13.0460-5936.2 13.0460-0439.2	605936 610439	21012 15,0 Belagsatz-Zubehör AKE AKE
INNOCENTI INNOCENTI								
	Mille Mini 120 Mini 650 Mini 90 Mini Diesel Mini Turbo De Tomaso Minitre Small 500/990			01.80 01.84 01.85 05.74 01.84 01.83 01.83 01.86	12.83 12.88 12.87 02.82 12.86 12.90 12.86 12.92	13.0460-6914.2	606914	20038 14,0 AP
	Elba Mille 1.0 i.e.			01.91 01.94		13.0460-5409.2	605409	21193 18,0 + ATE
	Mini 120 Mini 90 Mini Turbo De Tomaso			01.84 05.74 01.83	12.88 02.82 12.90	03.0137-0080.2 03.0137-9205.2	650080 669205	178 x 32 Bremsbacken-Zubehör AP AP
ISUZU TROOPER (81-86)								
	2.0 (UBS13) 2.2 D (UBS52)	45		09.81 09.81	11.86 11.86	24.0112-0145.1	412145	266 12,0 10,6
ISUZU TROOPER (86-91)								
	2.2 TD (UBS52) 2.3 (UBS16) 2.6 i (UBS17) 2.8 TD (UBS55)	53 66 85		02.90 02.90 02.90 02.90	12.91 12.91 12.91 12.91	24.3601-1715.5 24.3601-1716.5	240389 240390	D=60, - Halter D=60, - Halter AKE AKE
	2.2 TD (UBS52) 2.3 (UBS16) 2.6 i (UBS17) 2.8 TD (UBS55)	53 4524289 66 4524289 85 4524289 4524289			12.91 12.91 12.91 12.91	13.0460-5942.2 13.0460-0337.2	605942 610337	21544 16,5 +/WK Belagsatz-Zubehör AKE AKE
	2.2 TD (UBS52) 2.3 (UBS16) 2.6 i (UBS17) 2.8 TD (UBS55)	53 4524289 66 4524289 85 4524289 4524289			12.91 12.91 12.91 12.91	24.0122-0156.1	422156	257 22,0 20,6 V
	2.2 TD (UBS52) 2.3 (UBS16) 2.6 i (UBS17) 2.8 TD (UBS55)	53 K7100001 66 K7100001 85 K7100001 K7100001			12.91 12.91 12.91 12.91	24.0112-0145.1	412145	266 12,0 10,6
	2.2 TD (UBS52) 2.3 (UBS16) 2.6 i (UBS17) 2.8 TD (UBS55)	53 66 85		11.86 11.86 11.86 11.86	10.88 10.88 10.88 10.88	24.3225-1702.3	020425	Rz 25,40

IVECO EUROCARGO		IVECO LKW 75-330		IVECO Z-REIHE / ZETA		JAGUAR XJ (XJ40,81) (86-96)	
	60 E10		01.91		13.0460-4914.2	604914	29122 22,3 /WE BRE
	60 E12		01.91				
	60 E14		01.91				
	65 E10		01.91				
	65 E12		01.91				
	65 E14		01.91				
	75 E12		06.96				
	75 E14		06.96				
	75 E15		06.96				
	100 E15		01.91		13.0460-2843.2	602843	29067 22,3 /WE LUC
	100 E18		01.91		24.8190-2901.2	622901	2 Warnkontakt L=500mm
180 E21		01.91					
80 E15		01.87					
80 E18		01.87					
85 E15		01.87					
	60 E10		01.91		13.0460-4914.2	604914	29122 22,3 /WE BRE
	60 E12		01.91				
	60 E14		01.91				
	65 E10		01.91				
	65 E12		01.91				
	65 E14		01.91				
	75 E12		06.96				
	75 E14		06.96				
	75 E15		06.96				
	100 E15		01.91		13.0460-2843.2	602843	29067 22,3 /WE LUC
	100 E18		01.91		24.8190-2901.2	622901	2 Warnkontakt L=500mm
180 E21		01.91					
80 E15		01.87					
80 E18		01.87					
85 E15		01.87					
	110-13 A/AH		01.83		24.2423-0905.3	030070	Gz 23,81
	110-16 A		01.83				
	130-13 A/AH		01.83				
	130-16 A/AH/AHT		01.83				
	75-9 A		01.82				
	80-13 A/AH/AT/AW		01.83				
	80-16 A/AW		01.83				
	90-13 A/AH/AT		01.83				
	90-16 AW		01.83				
	110-13 A/AH		01.83	+ ZF-Getriebe 1)	24.2538-0901.3	040056	Nz 38,10
110-16 A		01.83	+ ZF-Getriebe 1)				
130-13 A/AH		01.83	+ ZF-Getriebe 1)				
130-16 A/AH/AHT		01.83	+ ZF-Getriebe 1)				
75-9 A		01.82					
80-13 A/AH/AT		01.83	+ ZF-Getriebe 1)				
80-13 AW		01.83					
80-16 A/AW		01.83					
90-13 A/AH/AT		01.83	+ ZF-Getriebe 1)				
90-16 AW		01.83					
	65		01.83		13.0460-4914.2	604914	29122 22,3 /WE BRE
	79.10		01.83				
	79.12		01.83				
	79.13		01.83				
	79.14		01.83				
	109.14		01.83		13.0460-2843.2	602843	29067 22,3 /WE LUC
	95.14		01.83		24.8190-2901.2	622901	2 Warnkontakt L=500mm
	65		01.83		13.0460-4914.2	604914	29122 22,3 /WE BRE
	79.10		01.83				
	79.12		01.83				
	79.13		01.83				
	79.14		01.83				
	XJ12 6.0	229	03.93	11.94	13.0460-7138.2	607138	23126 17,5 +/-WE ATE
	XJ6 2.9		10.86	08.90	24.8190-1302.2	621302	2 Warnkontakt L=276mm
	XJ6 3.2 24V	146	09.90	11.94			
	XJ6 3.6		10.86	08.89			
	XJ6 4.0	163	09.89	11.94			
	XJ12 6.0	229	03.93	11.94	24.0123-0108.1	423108	295 22,5 21,0 V
	XJ6 2.9		10.86	08.90	24.0128-0138.1	428138	291 28,1 26,0 V +B
	XJ6 3.2 24V	146	09.90	11.94			
	XJ6 3.6		10.86	08.89			
	XJ6 4.0	163	09.89	11.94			
	XJ12 6.0	229	03.93	11.94	13.0460-7246.2	607246	21275 17,0 +/-WE ATE
	XJ6 2.9		10.86	08.90			
	XJ6 3.2 24V	146	09.90	11.94			
	XJ6 3.6		10.86	08.89			
	XJ6 4.0	163	09.89	11.94			
	XJ12 6.0	229	03.93	11.94	24.0110-0319.1	410319	295 10,0 8,8
	XJ6 2.9		10.86	08.90			
	XJ6 3.2 24V	146	09.90	11.94			
	XJ6 3.6		10.86	08.89			

1) + ZF transmission / + scatola cambio ZF / + boîte de vitesse ZF / + cambio ZF

								
JAGUAR XJ (XJ40,81) (86-96)								
	XJ6 4.0	163	09.89	11.94	24.0110-0319.1	410319		295 10,0 8,8
JAGUAR XJS (88-96)								
	XJS 4.0 Cabrio XJS 4.0 Coupe XJS 5.3 Coupe XJS 6.0 Coupe		05.91 05.91 01.88 05.93	03.96 09.94 08.93 03.96	13.0460-7138.2 24.8190-1302.2	607138 621302	2	23126 17,5 +/-WE Warnkontakt L=276mm ATE
	XJS 4.0 Cabrio XJS 4.0 Coupe XJS 5.3 Coupe XJS 6.0 Coupe		05.91 05.91 01.88 05.93	03.96 09.94 08.93 03.96	24.0124-0174.1	424174		284 24,2 22,9 V
	XJS 4.0 Cabrio XJS 4.0 Coupe XJS 5.3 Coupe XJS 6.0 Coupe		05.91 05.91 01.88 05.93	03.96 09.94 08.93 03.96	13.0460-7246.2	607246		21275 17,0 +/-WE ATE
	XJS 4.0 Cabrio XJS 4.0 Coupe XJS 5.3 Coupe XJS 6.0 Coupe		05.91 05.91 01.88 05.93	03.96 09.94 08.93 03.96	24.0110-0319.1	410319		295 10,0 8,8
JEEP CHEROKEE(XJ)/WAGON(XJ)/COMANCHE(MJ) (87-04)								
	2.1 TD 4x4 2.5 i 4x4 2.5 TD 4x4 4.0 i 4x4		01.87 01.87 01.87 01.87	12.89 12.89 12.89 12.89	24.0122-0181.1	422181		280 22,2 20,7 V
	2.1 TD 2.1 TD 4x4 2.5 i 2.5 i 4x4 2.5 TD 2.5 TD 4x4 4.0 i 4.0 i 4x4		01.94 01.90 01.94 01.90 01.94 01.90 01.94 01.90	01.99 12.93 01.99 12.93 01.99 12.93 01.99 12.93	24.0124-0702.1	424702		280 24,0 22,7 V +B
JEEP WRANGLER I (YJ) (87-96)								
	2.5 4.0 4.2	131	01.87 01.87 08.86	12.89 12.89 08.89	24.0122-0181.1	422181		280 22,2 20,7 V
	2.5 4.0	131	01.90 01.90	12.96 12.96	24.0124-0702.1	424702		280 24,0 22,7 V +B
KÄSSBOHRER S 6 - S 215								
	S 100/A S 110/A S 120 A S 80 S 80 B S 80 E/H		01.67 01.67 01.67 01.67 01.75 01.68	12.69 12.69 12.69 12.77 12.77	03.3131-0601.3	010299		Hz 31,75 ATE
	S 120 S 125 S 130 S 140 S 150		01.67 01.67 01.67 01.71 01.67	12.77 + Trommelbremse ¹⁾ 12.71 + Trommelbremse ¹⁾ 12.84 + Trommelbremse ¹⁾ 12.83 + Trommelbremse ¹⁾ 12.77 + Trommelbremse ¹⁾	03.3131-0601.3	010299	+ Vorderachse ²⁾	Hz 31,75 ATE
	SG 180		01.71	12.83 + Trommelbremse ¹⁾	03.3131-0601.3	010299	+ Vorderachse ²⁾	Hz 31,75 ATE
	S 208 S 211		01.79 01.76	12.83 + Trommelbremse ¹⁾	03.3131-0601.3	010299	+ Vorderachse ²⁾	Hz 31,75 ATE
	S 212/213/215		01.76	+ Trommelbremse ¹⁾	03.3134-0300.3	010308	+ Vorderachse ²⁾	Hz 34,92 ATE
	S 212/213/215		01.76	12.77 + Scheibenbremse ³⁾	03.3138-2010.3	010311	+ Vorderachse ²⁾	Hz 38,10 ATE
	S 100/A S 110/A S 12 S 120 S 120 A S 125 S 130 S 14 S 140 S 150 S 200 S 208 S 6 S 80 S 80 B S 80 E/H S 9/10/11 SG 180		01.67 01.67 01.60 01.67 01.67 01.67 01.62 01.71 01.67 01.72 01.79 01.57 01.67 01.75 01.68 01.60 01.71	12.69 12.69 12.67 12.77 12.69 12.71 12.67 12.67 12.83 12.77 12.76 12.83 12.67 12.67 12.77 12.67 12.83	83.6103-0500.3	330230		L=500
	S 211 S 212/213/215		01.76 01.76	12.77	83.6103-0350.3 83.6103-0500.3	330225 330230		L=350 L=500
	S 212/213/215		01.78		83.6103-0500.3	330230		L=500

¹⁾ + drum brake / + freno a tamburo / + freins à tambour / + tambores de freno

²⁾ + front axle / + asse anteriore / + essieu avant / + eje delantero

³⁾ + disc brake / + disco freno / + disques de frein / + disco de freno

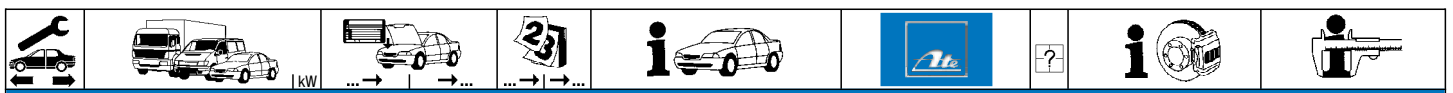

KÄSSBOHRER S 6 - S 215										
	S 12			01.60				83.6103-0500.3	330230	L=500
	S 14			01.62	12.67					
	S 6			01.57	12.67					
	S 9/10/11			01.60	12.67					
	S 80			01.67				83.6103-0450.3	330228	L=450
								83.6103-0500.3	330230	L=500
	S 100/A			01.67	12.69			83.6103-0500.3	330230	L=500
	S 110/A			01.67	12.69					
	S 120			01.67	12.77					
	S 120 A			01.67	12.69					
	S 125			01.67	12.71					
	S 130			01.67						
	S 140			01.71	12.83					
	S 150			01.67	12.77					
	S 208			01.79	12.83					
S 211			01.76							
S 212/213/215			01.76							
S 80 B			01.75	12.77						
S 80 E/H			01.68	12.77						
	S 130 S			01.71	12.84	+ Druckluftunterstützung ¹⁾		03.0450-3801.2	083801	Nz Reparatursatz
	S 140 ES	155102			12.83					
	SG 180			01.71	12.83			03.0450-3801.2	083801	Nz Reparatursatz
	S 200	162031			12.76			03.0450-3801.2	083801	Nz Reparatursatz
	S 208			01.79	12.83					
	S 209			01.77	12.83					
	S 211/212/213/215			01.76						

































KIA PRIDE Limousine (90-94)





























	1.1 i	38		01.91	04.94			13.0460-5970.2	605970	21355 13,5 +/WK Belagsatz-Zubehör	SUM SUM
	1.3 i 16V	44		01.90	04.94			13.0460-0451.2	610451		
	1.3 i 16V	51		01.90	04.94						
	1.3 i 16V	53		01.90	04.94						
	1.1 i	38		01.91	04.94			24.0113-0165.1	413165	219 13,0 11,0	
	1.3 i 16V	44		01.90	04.94						
	1.3 i 16V	51		01.90	04.94						
	1.3 i 16V	53		01.90	04.94						
	1.1 i	38		01.91	04.94			03.0137-0204.2	650204	170 x 25	
	1.3 i 16V	44		01.90	04.94						
	1.3 i 16V	51		01.90	04.94						
	1.3 i 16V	53		01.90	04.94						
	1.1 i	38		01.91	04.94			24.0217-0001.1	480198	170/171,5 x 34,5	
	1.3 i 16V	44		01.90	04.94						
	1.3 i 16V	51		01.90	04.94						
	1.3 i 16V	53		01.90	04.94						













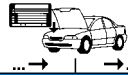



















LADA 1200-1600 (2101/2102/2103/2106) (73-86)





























	1200			05.73	06.86			24.2119-0831.3	010416	THz 19,05	
	1300			09.74	06.86						
	1500			09.75	06.85						
	1600			12.75	06.85						
	1200			05.73	06.86			13.0460-2966.2	602966	20166 16,0	LUC
	1300			09.74	06.86						
	1500			09.75	06.85						
	1600			12.75	06.85						
	1200			05.73	06.86			24.0111-0115.1	411115	253 10,0 9,0 +B	
	1300			09.74	06.86						
	1500			09.75	06.85						
	1600			12.75	06.85						
	1200			05.73	06.86			24.3220-1102.3	020213	Rz 20,64	
	1300			09.74	06.86						
	1500			09.75	06.85						
	1600			12.75	06.85						
	1200			05.73	06.86			03.0137-0232.2	650232	250 x 51 Bremsbacken-Zubehör	
	1300			09.74	06.86			03.0137-9117.2	669117		
	1500			09.75	06.85						
	1600			12.75	06.85						
	1200			05.73	06.86			03.0420-0620.3	680620	20,64/250x51 Kit	
	1300			09.74	06.86						
	1500			09.75	06.85						
	1600			12.75	06.85						
	1200			05.73	06.86			24.3727-2402.2	582402	L=2503	
	1300			09.74	06.86						
	1500			09.75	06.85						
	1600			12.75	06.85						
	1200			05.73	06.86			24.2419-1101.3	030085	Gz 19,05	
	1300			09.74	06.86						
	1500			09.75	06.85						
	1600			12.75	06.85						
	1200			05.73	06.86			24.2519-0505.3	040070	Nz 19,05	
	1300			09.74	06.86						
	1500			09.75	06.85						
	1600			12.75	06.85						









¹⁾ + air brake assistance / + servofreno ad aria / + assistance pneumatique / + freno de aire auxiliar

								
LADA FORMA (2108) (89-95)								
	1100 1300 1500			07.91 05.89 07.91	12.95 12.95 12.95	24.2120-0803.3	010415	Thz 20,64
	1100 1300 1500			07.91 05.89 07.91	12.95 12.95 12.95	13.0460-2965.2	602965	21170 17,3 LUC
	1100 1300 1500			07.91 05.89 07.91	12.95 12.95 12.95	24.0112-0125.1 24.0312-0125.1	412125 512125	239 12,0 10,8 +B 239 12,0 10,8 +B PD
	1100 1300 1500			07.91 05.89 07.91	12.95 12.95 12.95	24.5127-0305.3	330578	2 L=305
	1100 1300 1500			07.91 05.89 07.91	12.95 12.95 12.95	24.3220-1103.3	020214	Rz 20,64
	1100 1300 1500			07.91 05.89 07.91	12.95 12.95 12.95	03.0137-0231.2 03.0137-9118.2	650231 669118	200 x 41 Bremsbacken-Zubehör
	1100 1300 1500			07.91 05.89 07.91	12.95 12.95 12.95	24.0220-0020.1	480059	200/201,5 x 50
	1100 1300 1500			07.91 05.89 07.91	12.95 12.95 12.95	24.3727-2403.2	582403	2 ↓ L=1617
LADA NIVA (2121) (76-95)								
	1.6			12.76	03.95	24.2119-0832.3	010417	Thz 19,05
	1.6			12.76	03.95	13.0460-8006.2	608006	20660 15,6
	1.6			12.76	03.95	24.0112-0130.1	412130	272 11,0 9,9
	1.6			12.76	03.95	24.3220-1102.3	020213	Rz 20,64
	1.6			12.76	03.95	03.0137-0232.2 03.0137-9117.2	650232 669117	250 x 51 Bremsbacken-Zubehör
	1.6			12.76	03.95	24.0225-0004.1	480058	250/251,5 x 57,5
	1.6			12.76	03.95	03.0420-0620.3	680620	20,64/250x51 Kit
	1.6			12.76	03.95	24.3727-2401.2	582401	1 ↓ L=2122
LADA NIVA (2121) (93-)								
	1700 i 1700 i 4x4 1900 Diesel 1900 Diesel	59 60 47 55		06.96 10.00 03.93 01.99		24.2119-0832.3	010417	Thz 19,05
	1700 i 1700 i 4x4 1900 Diesel 1900 Diesel	59 60 47 55		06.96 10.00 03.93 01.99		13.0460-8006.2	608006	20660 15,6
	1700 i 1700 i 4x4 1900 Diesel 1900 Diesel	59 60 47 55		06.96 10.00 03.93 01.99		24.0112-0130.1	412130	272 11,0 9,9
	1700 i 1700 i 4x4 1900 Diesel 1900 Diesel	59 60 47 55		06.96 10.00 03.93 01.99		24.3220-1102.3	020213	Rz 20,64
	1700 i 1700 i 4x4 1900 Diesel 1900 Diesel	59 60 47 55		06.96 10.00 03.93 01.99		03.0137-0232.2	650232	250 x 51
	1700 i 1700 i 4x4 1900 Diesel 1900 Diesel	59 60 47 55		06.96 10.00 03.93 01.99		24.0225-0004.1	480058	250/251,5 x 57,5
LADA NOVA (2104/2105) (75-96)								
	1200 1300 1500 1600 1700			02.81 02.81 09.75 01.88 08.94	12.96 12.96 12.96 12.96 12.96	24.2119-0832.3	010417	Thz 19,05
↓	↓							

								
LADA NOVA (2104/2105) (75-96)								
	1200 1300 1500 1600 1700			02.81 02.81 09.75 01.88 08.94	12.96 12.96 12.96 12.96 12.96	13.0460-2966.2	602966	20166 16,0 LUC
	1200 1300 1500 1600 1700			02.81 02.81 09.75 01.88 08.94	12.96 12.96 12.96 12.96 12.96	24.0111-0115.1	411115	253 10,0 9,0 +B
	1200 1300 1500			02.81 02.81 09.75	12.96 12.96 12.96	24.3220-1103.3	020214	Rz 20,64
	1200 1300 1500			02.81 02.81 09.75	12.96 12.96 12.96	03.0137-0232.2 03.0137-9117.2	650232 669117	250 x 51 Bremsbacken-Zubehör
	1200 1300 1500			02.81 02.81 09.75	12.96 12.96 12.96	24.3727-2402.2	582402	1 ↓ L=2503
LADA TOSCANA (2107) (83-96)								
	1300 1500			09.85 09.83	12.96 02.93	13.0460-2966.2	602966	20166 16,0 LUC
	1300 1500			09.85 09.83	12.96 02.93	24.0111-0115.1	411115	253 10,0 9,0 +B
	1300 1500			09.85 09.83	12.96 02.93	24.3220-1103.3	020214	Rz 20,64
	1300 1500			09.85 09.83	12.96 02.93	03.0137-0232.2 03.0137-9117.2	650232 669117	250 x 51 Bremsbacken-Zubehör
	1300 1500			09.85 09.83	12.96 02.93	24.3727-2402.2	582402	1 ↓ L=2503
LANCIA DEDRA (90-93)								
	1.6 i.e. 1.8 i.e. 1.9 TD 2.0 i.e. 2.0 TD	66		01.90 01.90 01.90 01.90 01.90	10.93 10.93 10.93 10.93 10.93	24.2120-1710.3	010468	- ABS Thz 20,64
	2.0 i.e. Turbo 2.0 Integrale			05.91 09.91	10.93 10.93	24.2122-1716.3	010485	Thz 22,20
	1.6 i.e. 1.6 i.e. 1.8 i.e. 1.9 TD 2.0 i.e. 2.0 TD	66		01.90 02.93 01.90 01.90 01.90 01.90	01.93 + ABS 10.93 10.93 10.93 10.93	13.0460-2948.2 13.0460-2949.2	602948 602949	21100 16,7 +/WK/S LUC 20833 17,0 +/WK/S LUC
	2.0 i.e. Turbo 2.0 Integrale			05.91 09.91	10.93 10.93	13.0460-2979.2	602979	21147 19,0 +/WK/S LUC
	1.6 i.e. 1.6 i.e. 1.6 i.e. 1.8 i.e. 1.9 TD 2.0 TD	66		01.90 01.90 02.93 01.90 01.90 01.90	01.93 - ABS + ABS 10.93 10.93 10.93 10.93	24.0111-0119.1 24.0112-0127.1	411119 412127	241 11,0 9,2 +B 258 12,0 10,2 +B
	2.0 i.e. 2.0 i.e. Turbo 2.0 Integrale			01.90 05.91 09.91	10.93 10.93 10.93	24.0120-0142.1 24.0320-0142.1 24.0122-0107.1	420142 520142 422107	258 20,0 18,2 V L +B 258 20,0 18,2 V L +B PD 284 22,0 20,2 V +B
	1.6 i.e. 1.8 i.e. 1.9 TD 2.0 i.e. 2.0 i.e. Turbo 2.0 Integrale 2.0 TD	66		01.90 01.90 01.90 01.90 05.91 09.91 01.90	10.93 + ABS 10.93 10.93 10.93 10.93 10.93	24.3344-1703.5 24.3344-1704.5 24.0101-3601.2	240117 240118 260044	D=34, - Halter LUC D=34, - Halter LUC Bremsattel-Zubehör LUC
	1.6 i.e. 1.8 i.e. 1.9 TD 2.0 i.e. 2.0 i.e. Turbo 2.0 Integrale 2.0 TD	66		01.90 01.90 01.90 01.90 05.91 09.91 01.90	10.93 + ABS 10.93 10.93 10.93 10.93 10.93	13.0460-2951.2 13.0460-0072.2	602951 610072	21103 14,2 /S LUC Belagsatz-Zubehör LUC
	1.6 i.e. 1.8 i.e. 1.9 TD 2.0 i.e. 2.0 i.e. Turbo	66		01.90 01.90 01.90 01.90 05.91	10.93 + ABS 10.93 10.93 10.93	24.0111-0119.1	411119	241 11,0 9,2 +B

								
LANCIA DEDRA (90-93)								
	2.0 Integrale 2.0 TD		09.91 01.90	10.93 10.93	24.0111-0119.1	411119		241 11,0 9,2 +B
	1.6 i.e. 1.6 i.e.		01.90 02.93	10.93 10.93	24.3219-1102.3	020190		Rz 19,05 BDX
	1.6 i.e.		01.90	10.93	03.0137-0207.2	650207		180 x 32 BDX
	1.6 i.e.		01.90	10.93	03.0137-9088.2	669088		Bremsbacken-Zubehör BDX
	1.6 i.e.		01.90	10.93	24.0218-0011.1	480006		180/181,4 x 40
	1.6 i.e. 1.6 i.e.		01.90 02.93	01.93 10.93	03.0520-1219.3	691219		19,05/180x32 TopKit BDX
	1.6 i.e.		02.93	10.93	03.0420-4322.3	684322		22,20/180x32 Kit BDX
	1.6 i.e.		01.90	10.93	24.3727-0511.2	580511	<input type="checkbox"/>	L=1415
					24.3727-0510.2	580510	<input type="checkbox"/>	L=1375
	1.6 i.e. 1.8 i.e. 1.9 TD 2.0 i.e. 2.0 i.e. Turbo 2.0 TD	66	01.90 01.90 01.90 01.90 05.91 01.90	10.93 10.93 10.93 10.93 10.93 10.93	24.3727-0521.2	580521	<input type="checkbox"/>	L=1517
					24.3727-0006.2	580006	<input type="checkbox"/>	L=1460
	1.6 i.e. 1.8 i.e. 2.0 i.e.		01.90 01.90 01.90	10.93 10.93 10.93	24.3728-0503.2	590503		L=729
					24.3728-0502.2	590502		L=764
LANCIA DELTA (79-86)								
	1.6 GT 1.6 HF Turbo 1300 1500		04.83 08.83 10.79 10.79	06.86 06.86 06.86 06.86	24.2119-0829.3	010351		Thz 19,05
	1.6 GT 1.6 HF Turbo	285797 272995		06.86 06.86	13.0460-2941.2	602941		20839 17,0 /WK/S LUC
	1300 1500		10.79 10.79	06.86 06.86	24.0111-0130.1	411130		227 10,8 9,0 +B
	1.6 GT 1.6 HF Turbo		04.83 08.83	06.86 06.86	24.0112-0112.1	412112		257 12,0 10,8
	1.6 GT 1.6 HF Turbo		04.83 08.83	06.86 06.86	13.0460-3942.2	603942		20841 12,0 /WE BDX
	1.6 GT 1.6 HF Turbo		04.83 08.83	06.86 06.86	24.0111-0130.1	411130		227 10,8 9,0 +B
	1300 1500	262990 262990	10.79 10.79		24.3217-1115.3	020310		Rz 17,46 FI
	1300 1500	262991 262991		06.86 06.86	24.3219-0803.3	020183		Rz 19,05
	1300 1500		10.79 10.79	06.86 06.86	03.0137-0015.2	650015		185 x 31 AUT FI
					03.0137-9021.2	669021		Bremsbacken-Zubehör FI
	1300 1500		10.79 10.79	06.86 06.86	24.0218-5001.1	480012		185/186,8 x 37
	1300 1500	262990 262990	10.79 10.79		03.0420-0917.3	680917		17,46/185x31 Kit FI
	1300 1500	262991 262991		06.86 06.86	03.0420-0319.3	680319		19,05/185x31 Kit FI
LANCIA DELTA (86-93)								
	1.3 1.5 1.6 GT i.e. 1.6 i.e. 2.0 TD		07.86 07.86 08.86 07.86 07.86	10.93 10.93 10.93 10.93 10.93	24.2119-0829.3	010351		Thz 19,05
	1.6 i.e. 2.0 HF Integrale 2.0 i.e.16V Integrale 2.0 i.e. 16V 2.0 i.e. 16V Turbo		07.86 11.87 06.89 07.86 07.86	04.90 10.93 10.93 12.91 12.91	13.0460-2941.2	602941		20839 17,0 /WK/S LUC
					13.0460-4958.2	604958		21381 17,3 +/WK BRE
					13.0460-2980.2	602980		21147 19,0 +/WK/S LUC
					13.0460-2979.2	602979		21147 19,0 +/WK/S LUC
	1.3 1.5 1.6 i.e. 2.0 TD 1.6 GT i.e. 2.0 i.e. Turbo 2.0 HF Integrale 2.0 i.e.16V Integrale 2.0 i.e. 16V 2.0 i.e. 16V Turbo		07.86 07.86 07.86 07.86 08.86 07.86 11.87 06.89 07.86 07.86	10.93 10.93 10.93 10.93 10.93 12.91 10.93 10.93 12.91 12.91	24.0111-0130.1	411130		227 10,8 9,0 +B
					24.0112-0112.1	412112		257 12,0 10,8
					24.0120-0129.1	420129		257 20,0 18,2 V
					24.0126-0114.1	426114		281 26,0 24,2 V
					24.0122-0147.1	422147		284 22,0 20,2 V +B

								
LANCIA DELTA (86-93)								
	1.6 GT i.e. 1.6 i.e. 2.0 i.e. 16V 2.0 i.e. 16V Turbo		08.86 07.86 07.86 07.86	10.93 10.93 12.91 12.91	13.0460-3942.2	603942		20841 12,0 /WE BDX
	1.6 GT i.e. 1.6 i.e. 2.0 i.e. 16V 2.0 i.e. 16V Turbo 2.0 i.e. Turbo		08.86 07.86 07.86 07.86 07.86	10.93 10.93 12.91 12.91 12.91	24.0111-0130.1	411130		227 10,8 9,0 +B
	2.0 HF Integrale 2.0 i.e.16V Integrale		11.87 06.89	10.93 10.93	24.0110-0209.1	410209		251 10,0 9,0 +B
	1.3 1.5 2.0 TD		07.86 07.86 07.86	10.93 10.93 10.93	24.3219-0803.3	020183		Rz 19,05
	1.3 1.5 2.0 TD		07.86 07.86 07.86	10.93 10.93 10.93	03.0137-0015.2 03.0137-9021.2	650015 669021		185 x 31 AUT Bremsbacken-Zubehör FI
	1.3 1.5 2.0 TD		07.86 07.86 07.86	10.93 10.93 10.93	24.0218-5001.1	480012		185/186,8 x 37
	1.3 1.5 2.0 TD		07.86 07.86 07.86	10.93 10.93 10.93	03.0420-0319.3	680319		19,05/185x31 Kit FI
LANCIA PRISMA (83-86)								
	1.6 1.9 TD 1300 1500		04.83 06.85 04.83 04.83	06.86 06.86 06.86 06.86	24.2119-0829.3	010351		THz 19,05
	1.6	3067650		06.86	13.0460-2941.2	602941		20839 17,0 /WK/S LUC
	1300 1500		04.83 04.83	06.86 06.86	24.0111-0130.1	411130		227 10,8 9,0 +B
	1.6 1.9 TD		04.83 06.85	06.86 06.86	24.0112-0112.1	412112		257 12,0 10,8
	1.6		04.83	06.86	13.0460-3942.2	603942		20841 12,0 /WE BDX
	1.6		04.83	06.86	24.0111-0130.1	411130		227 10,8 9,0 +B
	1300 1500		3032272 04.83		24.3217-1115.3	020310		Rz 17,46 FI
	1.9 TD 1300 1500	3032273 3032273		06.85 06.86 06.86	24.3219-0803.3	020183		Rz 19,05
	1.9 TD 1300 1500		06.85 04.83 04.83	06.86 06.86 06.86	03.0137-0015.2 03.0137-9021.2	650015 669021		185 x 31 AUT Bremsbacken-Zubehör FI
	1.9 TD 1300 1500		06.85 04.83 04.83	06.86 06.86 06.86	24.0218-5001.1	480012		185/186,8 x 37
	1300 1500		3032272 04.83		03.0420-0917.3	680917		17,46/185x31 Kit FI
	1.9 TD 1300 1500	3032273 3032273		06.85 06.86 06.86	03.0420-0319.3	680319		19,05/185x31 Kit FI
LANCIA PRISMA (86-89)								
	1.3 1.5 1.6 1.6 i.e. 1.9 TD		07.86 07.86 07.86 07.86 07.86	06.89 06.89 06.89 06.89 06.89	24.2119-0829.3	010351		THz 19,05
	1.3 1.5		07.86 07.86	06.89 06.89	24.0111-0130.1	411130		227 10,8 9,0 +B
	1.6 1.6 i.e. 1.9 TD 2.0 i.e.		07.86 07.86 07.86 01.87	06.89 06.89 06.89 06.89	24.0112-0112.1	412112		257 12,0 10,8
	1.6 1.6 i.e.		07.86 07.86	06.89 06.89	13.0460-3942.2	603942		20841 12,0 /WE BDX
	1.6 1.6 i.e. 2.0 i.e.		07.86 07.86 01.87	06.89 06.89 06.89	24.0111-0130.1	411130		227 10,8 9,0 +B
	1.3 1.5 1.9 TD		07.86 07.86 07.86	06.89 06.89 06.89	24.3219-0803.3	020183		Rz 19,05

LANCIA PRISMA (86-89)													
	1.3 1.5 1.9 TD			07.86 07.86 07.86	06.89 06.89 06.89			03.0137-0015.2 03.0137-9021.2	650015 669021			185 x 31 AUT Bremsbacken-Zubehör	FI FI
	1.3 1.5 1.9 TD			07.86 07.86 07.86	06.89 06.89 06.89			24.0218-5001.1	480012			185/186,8 x 37	
	1.3 1.5 1.9 TD			07.86 07.86 07.86	06.89 06.89 06.89			03.0420-0319.3	680319			19,05/185x31 Kit	FI
LANCIA THEMA (84-88)													
	2.9 i.e. 8.32			09.87	01.89			13.0460-2980.2	602980			21147 19,0 +/WK/S	LUC
	2.0 i.e. 2.0 i.e. Turbo 2.5 TD 2.8 i.e. V6			10.84 10.84 10.84 10.84	01.89 01.89 01.89 01.89			24.0120-0129.1	420129			257 20,0 18,2 V	
	2.0 i.e. 2.0 i.e. Turbo 2.8 i.e. V6 2.9 i.e. 8.32			10.84 10.84 10.84 09.87	01.89 01.89 01.89 01.89			24.0122-0145.1	422145			284 22,0 20,2 V +B	
	2.0 i.e. 2.0 i.e. Turbo 2.5 TD 2.8 i.e. V6 2.9 i.e. 8.32			10.84 10.84 10.84 10.84 09.87	01.89 01.89 01.89 01.89 01.89			13.0460-2962.2 13.0460-0072.2	602962 610072			20668 16,6 /S Belagsatz-Zubehör	LUC LUC
	2.0 i.e. 2.0 i.e. Turbo 2.5 TD 2.8 i.e. V6			10.84 10.84 10.84 10.84	01.89 01.89 01.89 01.89			24.0110-0190.1	410190			252 10,0 9,0 +B	
	2.0 i.e. 2.0 i.e. Turbo 2.5 TD 2.8 i.e. V6 2.9 i.e. 8.32			10.84 10.84 10.84 10.84 09.87	01.89 01.89 01.89 01.89 01.89			24.0110-0209.1	410209			251 10,0 9,0 +B	
	2.0 i.e. 2.0 i.e. Turbo 2.5 TD 2.8 i.e. V6 2.9 i.e. 8.32			10.84 10.84 10.84 10.84 09.87	01.89 01.89 01.89 01.89 01.89			24.3727-0514.2	580514	1		L=2950	
	2.0 i.e. 2.0 i.e. Turbo 2.5 TD 2.8 i.e. V6 2.9 i.e. 8.32			10.84 10.84 10.84 10.84 09.87	01.89 01.89 01.89 01.89 01.89								
	2.0 i.e. 2.0 i.e. Turbo 2.5 TD 2.8 i.e. V6 2.9 i.e. 8.32			10.84 10.84 10.84 10.84 09.87	01.89 01.89 01.89 01.89 01.89								
LANCIA THEMA (89-92)													
	2.0 i.e. 2.0 i.e. 16V 2.0 i.e. Turbo 2.5 TD 2.8 i.e. V6			02.89 10.89 02.89 02.89 02.89	09.92 09.92 09.92 09.92 09.92			13.0460-2952.2	602952			21185 19,4 +/WK/S	LUC
	2.0 i.e. 2.0 i.e. 16V 2.0 i.e. 16V Turbo 2.0 i.e. Turbo 2.8 i.e. V6 2.9 i.e. 8.32			02.89 10.89 10.89 02.89 02.89 02.89	09.92 09.92 09.92 09.92 09.92 09.92			13.0460-2979.2	602979			21147 19,0 +/WK/S	LUC
	2.0 i.e. 2.0 i.e. 16V 2.0 i.e. 16V Turbo 2.0 i.e. Turbo 2.8 i.e. V6 2.9 i.e. 8.32			02.89 10.89 10.89 02.89 02.89 02.89	09.92 09.92 09.92 09.92 09.92 09.92			24.0114-0102.1	414102			258 14,0 12,8	
	2.0 i.e. 2.0 i.e. 16V 2.5 TD 2.8 i.e. V6			02.89 10.89 02.89 02.89	09.92 09.92 09.92 09.92			24.0122-0130.1	422130			257 22,0 20,2 V	
	2.0 i.e. 16V Turbo 2.0 i.e. Turbo 2.0 i.e. 2.0 i.e. 16V 2.0 i.e. 16V Turbo 2.0 i.e. Turbo 2.8 i.e. V6 2.9 i.e. 8.32			10.89 02.89 02.89 10.89 10.89 02.89 02.89 02.89	09.92 09.92 09.92 09.92 09.92 09.92 09.92 09.92			24.0122-0147.1 24.0122-0145.1	422147 422145			284 22,0 20,2 V +B 284 22,0 20,2 V +B	
	2.0 i.e. 2.0 i.e. 16V 2.0 i.e. 16V Turbo 2.0 i.e. Turbo 2.5 TD 2.8 i.e. V6 2.9 i.e. 8.32			02.89 10.89 10.89 02.89 02.89 02.89 02.89	09.92 09.92 09.92 09.92 09.92 09.92 09.92			13.0460-2962.2 13.0460-0072.2	602962 610072			20668 16,6 /S Belagsatz-Zubehör	LUC LUC
	2.0 i.e. 2.0 i.e. 16V 2.0 i.e. 16V Turbo 2.0 i.e. Turbo 2.5 TD 2.8 i.e. V6			02.89 10.89 10.89 02.89 02.89 02.89	09.92 09.92 09.92 09.92 09.92 09.92			24.0110-0190.1	410190			252 10,0 9,0 +B	
	2.0 i.e. 2.0 i.e. 16V 2.0 i.e. 16V Turbo 2.0 i.e. Turbo 2.5 TD 2.8 i.e. V6			02.89 10.89 10.89 02.89 02.89 02.89	09.92 09.92 09.92 09.92 09.92 09.92			24.0110-0209.1	410209			251 10,0 9,0 +B	
	2.0 i.e. 2.0 i.e. 16V 2.0 i.e. 16V Turbo 2.0 i.e. Turbo 2.5 TD 2.8 i.e. V6			02.89 10.89 10.89 02.89 02.89 02.89	09.92 09.92 09.92 09.92 09.92 09.92								
	2.0 i.e. 2.0 i.e. 16V 2.0 i.e. 16V Turbo 2.0 i.e. Turbo 2.5 TD 2.8 i.e. V6			02.89 10.89 10.89 02.89 02.89 02.89	09.92 09.92 09.92 09.92 09.92 09.92								























1) + ABS/ - armoured vehicles / + ABS/ - veicoli blindati / + ABS/ - véhicule blindé / + ABS/ - vehiculo blindado

2) - armoured vehicles / - veicoli blindati / - véhicule blindé / - vehiculo blindado

3) + armoured vehicles / + veicoli blindati / + véhicule blindé / + vehiculo blindado

4) - long wheel base / - passo lungo / - empattement long / - distancia larga entre ejes

5) - ABS/ - armoured vehicles / - ABS/ - veicoli blindati / - ABS/ - véhicule blindé / - ABS/ - vehiculo blindado

									
LANCIA THEMA (89-92)									
	2.9 i.e. 8.32			02.89	09.92		24.0110-0209.1	410209	251 10,0 9,0 +B
	2.0 i.e. 2.0 i.e. 16V 2.0 i.e. 16V Turbo 2.0 i.e. Turbo 2.5 TD 2.8 i.e. V6 2.9 i.e. 8.32			02.89 10.89 10.89 02.89 02.89 02.89 02.89	09.92 09.92 09.92 09.92 09.92 09.92 09.92		24.3727-0514.2	580514	1 ↓ L=2950
LANCIA THEMA (92-94)									
	2.0 i.e. 2.0 i.e. 16V 2.5 TD			10.92 10.92 10.92	12.94 12.94 12.94	- gepanzerte Fahrzeuge ¹⁾	13.0460-2952.2	602952	21185 19,4 +/WK/S LUC
	2.0 i.e. 16V 2.0 i.e. 16V Turbo 3.0 i.e. V6			10.92 10.92 10.92	12.94 12.94 12.94	+ gepanzerte Fahrzeuge ²⁾	13.0460-2979.2	602979	21147 19,0 +/WK/S LUC
	2.0 i.e. 2.0 i.e. 16V 2.5 TD			10.92 10.92 10.92	12.94 12.94 12.94	- gepanzerte Fahrzeuge ¹⁾	24.0122-0130.1	422130	257 22,0 20,2 V
	2.0 i.e. 16V Turbo 3.0 i.e. V6			10.92 10.92	12.94 12.94	- gepanzerte Fahrzeuge ¹⁾ - gepanzerte Fahrzeuge ¹⁾	24.0122-0147.1	422147	284 22,0 20,2 V +B
	2.0 i.e. 16V 2.0 i.e. 16V Turbo 3.0 i.e. V6			10.92 10.92 10.92	12.94 12.94 12.94	+ gepanzerte Fahrzeuge ²⁾ + gepanzerte Fahrzeuge ²⁾ + gepanzerte Fahrzeuge ²⁾	24.0122-0145.1	422145	284 22,0 20,2 V +B
	2.0 i.e. 2.0 i.e. 16V 2.0 i.e. 16V Turbo 2.5 TD 3.0 i.e. V6			10.92 10.92 10.92 10.92 10.92	12.94 12.94 12.94 12.94 12.94		24.3384-1608.5	240168	☐ D=38, - Halter LUC
	2.0 i.e. 2.0 i.e. 16V 2.0 i.e. 16V Turbo 2.5 TD 3.0 i.e. V6			10.92 10.92 10.92 10.92 10.92	12.94 12.94 12.94 12.94 12.94		13.0460-2962.2 13.0460-0072.2	602962 610072	20668 16,6 /S LUC Belagsatz-Zubehör LUC
	2.0 i.e. 2.0 i.e. 16V 2.0 i.e. 16V Turbo 2.5 TD 3.0 i.e. V6			10.92 10.92 10.92 10.92 10.92	12.94 12.94 12.94 12.94 12.94	- gepanzerte Fahrzeuge ¹⁾ - gepanzerte Fahrzeuge ¹⁾ - gepanzerte Fahrzeuge ¹⁾	24.0110-0190.1	410190	252 10,0 9,0 +B
	2.0 i.e. 16V 2.0 i.e. 16V Turbo 3.0 i.e. V6			10.92 10.92 10.92	12.94 12.94 12.94	+ gepanzerte Fahrzeuge ²⁾ + gepanzerte Fahrzeuge ²⁾ + gepanzerte Fahrzeuge ²⁾	24.0110-0209.1	410209	251 10,0 9,0 +B
	2.0 i.e. 2.0 i.e. 16V 2.0 i.e. 16V Turbo 2.5 TD 3.0 i.e. V6			10.92 10.92 10.92 10.92 10.92	12.94 12.94 12.94 12.94 12.94		24.3727-0545.2	580545	1 ↓ L=2945
LANCIA Y 10 (85-95)									
	1.0 Fire 1.0 Fire 4WD 1.0 Turbo 1.1 4WD 1.1 Fire 1.3 Fire			06.85 06.85 06.85 12.86 01.90 02.89	02.92 02.92 02.89 12.92 12.92 12.92		24.2120-0801.3	010362	THz 20,64
	1.1 4WD 1.1 Fire 1.3 Fire			01.93 01.93 01.93	12.95 12.95 12.95		24.2120-1733.3	010686	THz 20,64
	1.0 Fire 1.0 Fire 4WD 1.1 4WD 1.1 Fire			06.85 12.86 01.90 01.90	12.95 12.95 12.95 12.95		13.0460-3940.2 13.0460-0410.2	603940 610410	20775 18,0 /WK BDX Belagsatz-Zubehör BDX
	1.0 Turbo 1.3 Fire			06.85 02.89	12.95 12.95		13.0460-2941.2	602941	20839 17,0 /WK/S LUC
	1.0 Fire 1.0 Fire 4WD 1.1 4WD 1.1 Fire			06.85 12.86 01.90 01.90	12.95 12.95 12.95 12.95		24.0111-0130.1	411130	227 10,8 9,0 +B
	1.0 Turbo 1.3 Fire			06.85 02.89	12.95 12.95		24.0112-0122.1	412122	240 12,0 10,8
	1.0 Fire 1.0 Fire 4WD 1.0 Turbo 1.1 4WD 1.1 Fire 1.3 Fire			06.85 12.86 06.85 01.90 01.90 02.89	12.95 12.95 12.95 12.95 12.95 12.95		24.3219-0803.3	020183	Rz 19,05
	1.0 Fire 1.0 Fire 4WD 1.0 Turbo 1.1 4WD 1.1 Fire 1.3 Fire			06.85 12.86 06.85 01.90 01.90 02.89	12.95 12.95 12.95 12.95 12.95 12.95		03.0137-0015.2 03.0137-0273.2 03.0137-9021.2	650015 650273 669021	185 x 31 AUT FI 185 x 31 AUT AP Bremsbacken-Zubehör FI

1) - armoured vehicles / - veicoli blindati / - véhicule blindé / - vehículo blindado
2) + armoured vehicles / + veicoli blindati / + véhicule blindé / + vehículo blindado

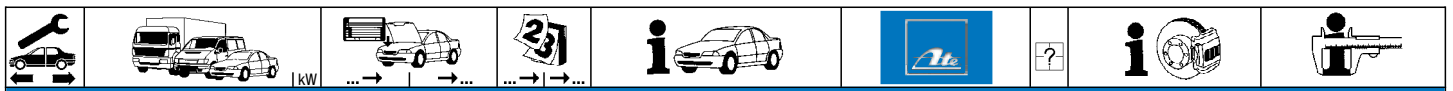



















LANCIA Y 10 (85-95)											
	1.0 Fire 1.0 Fire 4WD 1.0 Turbo 1.1 4WD 1.1 Fire 1.3 Fire			06.85 12.86 06.85 01.90 01.90 02.89	12.95 12.95 12.95 12.95 12.95 12.95		24.0218-5001.1	480012		185/186,8 x 37	
	1.0 Fire 1.0 Fire 4WD 1.0 Turbo 1.1 4WD 1.1 Fire 1.3 Fire			06.85 12.86 06.85 01.90 01.90 02.89	12.95 12.95 12.95 12.95 12.95 12.95		03.0420-0319.3 03.0520-4319.3	680319 694319		19,05/185x31 Kit 19,05/185x31 TopKit	FI AP
	1.0 Fire 1.0 Turbo 1.1 Fire 1.3 Fire			06.85 06.85 01.90 02.89	12.92 12.92 12.92 12.92		24.3727-0519.2	580519	1 ↓	L=2385	
	1.0 Fire 4WD 1.1 4WD			12.86 01.90	12.95 12.95		24.3727-0503.2	580503	1 ↓	L=2670	
	1.0 Fire 1.0 Fire 4WD 1.0 Turbo 1.1 4WD 1.1 Fire 1.3 Fire			06.85 12.86 06.85 01.90 01.90 02.89	12.95 12.95 12.95 12.95 12.95 12.95		24.6513-0801.3	320117		BRL 1/3 (2)	

LAND ROVER 90/110 (83-90)											
	2.5 4x4 2.5 TD 4x4 3.5 4x4	62 63 100		09.85 09.86 09.83	07.90 09.90 07.90		13.0460-6925.2	606925		21519 17,8 /Zub	AP
	2.5 4x4 2.5 TD 4x4 3.5 4x4	62 63 100		09.85 09.86 09.83	07.90 09.90 07.90		24.0114-0108.1	414108		299 14,0 13,0 +B	

LAND ROVER DEFENDER (LD) (90-)											
	2.5 D 4x4 2.5 TD5 2.5 TDI 3.9 V8	51 90 83 136	(V)HA701009 (V)HA701009 (V)HA701009	09.90 06.98 09.90 11.98	09.01 + Radstand 2286 mm ¹⁾ + Radstand 2286 mm ¹⁾ + Radstand 2286 mm ¹⁾		13.0460-6922.2 13.0460-0154.2	606922 610154		21459 17,5 /Zub Belagsatz-Zubehör	AP AP
	2.4 Td4 2.5 TD5 2.5 TDI 3.9 V8	90 90 (V)HA701010 83 (V)HA701010 136 (V)HA701010		05.07			13.0460-6925.2	606925		21519 17,8 /Zub	AP
	2.4 Td4 2.5 TD5 2.5 TDI 3.9 V8	90 90 83 136		05.07 06.98 09.90 11.98			24.0114-0108.1	414108		299 14,0 13,0 +B	
	2.4 Td4 2.5 D 4x4 2.5 TD5 2.5 TDI 3.9 V8	90 (V)LA930456 51 90 (V)LA930456 83 (V)LA930456 136 (V)LA930456		09.90			24.0124-0143.1	424143		299 24,0 22,0 V +B	
	2.4 Td4 2.4 Td4 2.5 TD5 2.5 TD5 2.5 TDI 2.5 TDI 3.9 V8 3.9 V8	90 90 90 90 83 83 136 136	(V)1A614447 (V)1A614447 (V)1A614447 (V)1A614447 (V)1A614447 (V)1A614447 (V)1A614447 (V)1A614447	05.07 05.07 06.98 06.98 09.90 09.90 11.98 11.98	+ Radstand 2794 mm ²⁾ + Radstand 3302 mm ³⁾ + Radstand 2794 mm ²⁾ + Radstand 3302 mm ³⁾ + Radstand 2794 mm ²⁾ + Radstand 3302 mm ³⁾ + Radstand 2794 mm ²⁾ + Radstand 3302 mm ³⁾		13.0460-6923.2	606923		23471 14,5 +	AP
	2.4 Td4 2.4 Td4 2.5 TD5 2.5 TD5 2.5 TDI 2.5 TDI 3.9 V8 3.9 V8	90 (V)1A614448 90 (V)1A614448 90 (V)1A614448 90 (V)1A614448 83 (V)1A614448 83 (V)1A614448 136 (V)1A614448 136 (V)1A614448			+ Radstand 2794 mm ²⁾ + Radstand 3302 mm ³⁾ + Radstand 2794 mm ²⁾ + Radstand 3302 mm ³⁾ + Radstand 2794 mm ²⁾ + Radstand 3302 mm ³⁾ + Radstand 2794 mm ²⁾ + Radstand 3302 mm ³⁾		13.0460-6924.2	606924		23471 17,5 +/Zub	AP
	2.4 Td4 2.5 D 4x4 2.5 TD5 2.5 TDI 3.9 V8	90 51 90 83 136		05.07 09.90 06.98 09.90 11.98	09.01 + Radstand 2286 mm ¹⁾ + Radstand 2286 mm ¹⁾ + Radstand 2286 mm ¹⁾		24.0113-0189.1	413189		290 12,5 11,7 +B	
	2.4 Td4 2.4 Td4 2.5 TD5 2.5 TD5 2.5 TDI 2.5 TDI 3.9 V8 3.9 V8	90 90 90 90 83 83 136 136	(V)WA159806 (V)WA159806 (V)WA159806 (V)WA159806 (V)WA159806 (V)WA159806 (V)WA159806 (V)WA159806	05.07 05.07 06.98 06.98 09.90 09.90 11.98 11.98	- ABS/ + Radstand 2794 mm ⁴⁾ - ABS/ + Radstand 3302 mm ⁵⁾ - ABS/ + Radstand 2794 mm ⁴⁾ - ABS/ + Radstand 3302 mm ⁵⁾ - ABS/ + Radstand 2794 mm ⁴⁾ - ABS/ + Radstand 3302 mm ⁵⁾ - ABS/ + Radstand 2794 mm ⁴⁾ - ABS/ + Radstand 3302 mm ⁵⁾		24.0114-0108.1	414108		299 14,0 13,0 +B	
	2.4 Td4 2.4 Td4 2.5 TD5 2.5 TD5 2.5 TDI	90 (V)XA159807 90 (V)XA159807 90 (V)XA159807 90 (V)XA159807 83 (V)XA159807			+ Radstand 2794 mm ²⁾ + Radstand 3302 mm ³⁾ + Radstand 2794 mm ²⁾ + Radstand 3302 mm ³⁾ + Radstand 2794 mm ²⁾		24.0114-0115.1	414115		298 14,0 13,0	



















¹⁾ + wheel base 2286 mm / + passo 2286 mm / + empattement 2286 mm / + distancia entre ejes 2286 mm
²⁾ + wheel base 2794 mm / + passo 2794 mm / + empattement 2794 mm / + distancia entre ejes 2794 mm
³⁾ + wheel base 3302 mm / + passo 3302 mm / + empattement 3302 mm / + distancia entre ejes 3302 mm
⁴⁾ - ABS/ + wheel base 2794 mm / - ABS/ + passo 2794 mm / - ABS/ + empattement 2794 mm / - ABS/ + distrueda 2794 mm
⁵⁾ - ABS/ + wheel base 3302 mm / - ABS/ + passo 3302 mm / - ABS/ + empattement 3302 mm / - ABS/ + distrueda 3302 mm



LAND ROVER DEFENDER (LD) (90-)										
	2.5 TDI 3.9 V8 3.9 V8	83 (V)XA159807 136 (V)XA159807 136 (V)XA159807						+ Radstand 3302 mm ¹⁾ + Radstand 2794 mm ²⁾ + Radstand 3302 mm ¹⁾	24.0114-0115.1 414115	298 14,0 13,0
LAND ROVER RANGE ROVER I (70-94)										
	2.4 D 3.5 VOGUE 3.9 KAT 4.3 VOGUE LSE	78 93 127 149		04.86 12.90 10.85 09.90	12.90 09.90 07.94 07.94				24.2125-1710.3 010559	Thz 25,40
	2.4 D 3.5 3.5 VOGUE 3.9 KAT 3.9 VOGUE	78 107 120 127 134	(V)FA399972 (V)FA399972 (V)FA399972 (V)FA399972 (V)FA399972	04.86 01.87 10.85 11.88 11.88					13.0460-6926.2 606926	21160 19,2 +/WK/Zub AP
	2.4 D 3.5 3.5 VOGUE 3.9 KAT 3.9 VOGUE 4.3 VOGUE LSE	78 107 120 127 134 149	(V)GA399973 (V)GA399973 (V)GA399973 (V)GA399973 (V)GA399973 (V)GA399973	04.86 09.90 09.90 07.94 07.94 09.92	12.90 09.90 09.90 07.94 07.94 07.94				13.0460-6916.2 606916 13.0460-0154.2 610154	21459 18,5 +/WK Belagsatz-Zubehör AP AP
	2.4 D 3.5 3.5 VOGUE 3.9 KAT 3.9 VOGUE	78 107 120 127 134	(V)FA399972 (V)FA399972 (V)FA399972 (V)FA399972 (V)FA399972	04.86 07.87 10.85 11.88 11.88					24.0114-0108.1 414108	299 14,0 13,0 +B
	2.4 D 3.5 3.5 VOGUE 3.9 KAT 3.9 VOGUE 4.3 VOGUE LSE	78 107 120 127 134 149	(V)GA399973 (V)GA399973 (V)GA399973 (V)GA399973 (V)GA399973 (V)GA399973	12.90 09.90 09.90 07.94 07.94 09.92	12.90 09.90 09.90 07.94 07.94 07.94				24.0124-0143.1 424143	299 24,0 22,0 V +B
	2.4 D 3.5 3.5 VOGUE 3.9 KAT 3.9 VOGUE 4.3 VOGUE LSE	78 107 120 127 134 149		04.86 07.87 10.85 11.88 11.88 09.92	12.90 09.90 09.90 07.94 07.94 07.94				13.0460-6917.2 606917 13.0460-0414.2 610414	21237 15,5 +/WK/Zub Belagsatz-Zubehör AP AP
	2.4 D 3.5 3.5 VOGUE 3.9 KAT 3.9 VOGUE 4.3 VOGUE LSE	78 107 120 127 134 149		04.86 07.87 10.85 11.88 11.88 09.92	12.90 09.90 09.90 07.94 07.94 07.94				24.0113-0189.1 413189	290 12,5 11,7 +B
LLOYD (55-61)										
	LP 250 LP/LC/LS 400 LP/LC/LS 600 LS 600 - Alexander			01.56 01.55 01.55 01.56	12.58 12.58 12.58 12.61				83.7704-0290.3 330826	L=290
	LP 250 LP/LC/LS 400 LP/LC/LS 600 LS 600 - Alexander			01.56 01.55 01.55 01.56	12.58 12.58 12.58 12.61				03.3215-0221.3 020013	Rz 15,87
MAGIRUS BUS SATURN										
	Saturn II			01.58	12.64				83.6103-0500.3 330230	L=500
MAGIRUS BUS 100										
	100 R 170								83.6103-0500.3 330230	L=500
	100 R 170								83.6103-0550.3 330231	L=550
MAGIRUS BUS 110										
	110 E 6								83.6103-0550.3 330231	L=550
	110 E 6								83.6103-0500.3 330230	L=500
	110 E 6								83.6103-0550.3 330231	L=550
MAGIRUS BUS 120										
	120 R 80			01.69	12.77				03.3138-2001.3 010310 03.0370-1038.2 051038 03.0370-9998.2 059998	Hz 38,10 Hz Reparatursatz Hz Rep. Satz, -Kolben ATE ATE
	120 R 80			01.69	12.77				83.6103-0300.3 330223 83.6103-0450.3 330228	L=300 L=450

¹⁾ + wheel base 3302 mm / + passo 3302 mm / + empattement 3302 mm / + distancia entre ejes 3302 mm





²⁾ + wheel base 2794 mm / + passo 2794 mm / + empattement 2794 mm / + distancia entre ejes 2794 mm

MAGIRUS BUS 120		01.69 12.77		83.6103-0650.3 330235		L=650	
	120 R 80						
	120 L 80 120 R 80	01.68 01.69	12.69 12.77	83.6103-0300.3	330223		L=300
MAGIRUS BUS 130		01.77 12.82		83.6103-0300.3 330223 83.6103-0550.3 330231		L=300 L=550	
	130 L/R 81 130 R 81 F	01.77 01.77	12.82 12.82			■	
MAGIRUS BUS 150		01.64 12.67 01.64 12.68		03.0370-1131.2 051131		+ Vorder- u. Hinterachse ¹⁾ Hz Reparatursatz	
	150 LS 12 150 S 11	01.64 01.64	12.67 12.68				
	150 KVB S 11	01.67	12.68	03.3134-0300.3	010308	2	Hz 34,92 ATE
	150 KVB S11 150 L/R 10 150 L/R 12 150 LS 12 150 S 11	01.67 01.64 01.64 01.64 01.64	12.68 12.69 12.67 12.67 12.68	83.6103-0500.3	330230		L=500
MAGIRUS BUS 160-180		01.71 12.76 01.69 12.74 01.68 12.71 01.74 12.76		03.3134-0300.3 010308 <th colspan="2">Hz 34,92 ATE</th>		Hz 34,92 ATE	
	170 E 100 170 DSH/SH 110 170 L/R 120 170 S 11 H 180 SH 110	01.71 01.69 01.68 01.74	12.76 12.74 12.71 12.76	03.3134-0300.3	010308	2	Hz 34,92 ATE
	160 R 81 170 E 100	01.77 01.77	12.82 12.82	83.6103-0300.3 83.6103-0550.3	330223 330231	■	L=300 L=550
	170 DSH/SH/EV 110 170 E 100 170 L/R 120 170 L/R/TL/TR 100 170 S 11 H 180 SH 110	01.71 01.70 01.69 01.68 01.74	12.76 12.74 12.78 12.71 12.76	83.6103-0500.3	330230		L=500
	170 E 100 170 L/R 120 170 L/R/TL/TR 100	01.69 01.69	12.74 12.78	83.6103-0550.3	330231		L=550
MAGIRUS BUS 200		01.70 12.74 01.70 12.76 01.73 12.77		03.3134-0300.3 010308 <th colspan="2">2 Hz 34,92 ATE</th>		2 Hz 34,92 ATE	
	200 L/TL 120 200 R/TR 120 200 SH 110	01.70 01.70 01.73	12.74 12.76 12.77				
	200 L/R/TL/TR 100 200 L/R/TL/TR 120 200 SH 110	01.69 01.70 01.73	12.77 12.76 12.77	83.6103-0500.3	330230		L=500
	200 L/R/TL/TR 100 200 L/R/TL/TR 120	01.69 01.70	12.77 12.76	83.6103-0550.3	330231		L=550
MAGIRUS BUS 230		01.69 12.74 01.73 12.82 01.69 12.78		03.3134-0300.3 010308 <th colspan="2">2 Hz 34,92 ATE</th>		2 Hz 34,92 ATE	
	230 E 100 230 L 120 230 L/T/TR 117 230 R/TL/TR 120 230 SH 110	01.69 01.73 01.69	12.74 12.82 12.78	03.3134-0300.3	010308	2	Hz 34,92 ATE
	230 R 120	01.69	12.78	83.6103-0650.3	330235		L=650
	230 E 110 230 L 120 230 L/R/T 100 230 R/TL/TR 120 230 SH 110 230 TL/TR 100	01.69 01.69	12.74 12.78	83.6103-0500.3	330230		L=500
	230 E 110 230 E 120 230 E/L/R/T 100 230 L/TL/TR 120 230 TL/TR 100	01.69	12.78	83.6103-0550.3	330231		L=550
	230 R 120 230 R 120	01.69 01.73	12.72 12.78	83.6103-0550.3	330231		L=550 L=550
MAGIRUS BUS 232/260		01.70 12.78		83.6103-0500.3 330230		L=500	
	232 TR 100						

¹⁾ + front axle and rear axle / + asse anteriore + posteriore / + ess. avant et ess. arrière / + eje delantero + eje trasero

²⁾ + 2x MC 31,75 / + 2x PF 31,75 / + 2x MC 31,75 / + 2x CM 31,75

³⁾ + MC 34,92/38,10 / + PF 34,92/38,10 / + MC 34,92/38,10 / + CM 34,92/38,10

MAGIRUS LKW JUPITER											
	Jupiter 6x6		01.63	12.64		03.3138-2001.3	010310			Hz 38,10	ATE
	Jupiter 6x6		01.63	12.64		83.6103-0300.3	330223			L=300	
	Jupiter 6x6		01.63	12.64		83.6103-0650.3	330235			L=650	
						83.6103-0400.3	330226	<input type="checkbox"/>		L=400	
MAGIRUS LKW MERCUR											
	Mercur 126 Mercur F 150 A		01.63 01.62	12.64 12.64		03.0370-1131.2	051131			Hz Reparatursatz	
	Mercur F 126 Mercur F 150 A		01.63 01.62	12.64 12.64		83.6103-0550.3	330231			L=550	
	Mercur F 126 Mercur F 150 A		01.63 01.62	12.64 12.64		83.6103-0500.3	330230			L=500	
	Mercur F 150 A		01.62	12.64		03.2515-1101.3	040001			Nz 15,87	
						03.0450-1502.2	081502			Nz Reparatursatz	
MAGIRUS LKW SATURN/PLUTO											
	Saturn 150 Saturn A/AK Saturn S		01.60 01.58 01.59	12.64 12.64 12.64		83.6103-0550.3	330231			L=550	
	Pluto 200 Saturn 200		01.60 01.60	12.64 12.64		83.6103-0650.3	330235			L=650	
	Saturn 150 Saturn A/AK Saturn S		01.60 01.58 01.59	12.64 12.64 12.64		83.6103-0550.3	330231			L=550	
	Pluto 200 Saturn 200		01.60 01.60	12.64 12.64		83.6103-0650.3	330235			L=650	
	Saturn II		01.60	12.64		83.6103-0500.3	330230			L=500	
	Saturn S		01.59	12.63		03.2515-1101.3	040001			Nz 15,87	
						03.0450-1502.2	081502			Nz Reparatursatz	
MAGIRUS LKW SIRIUS											
	Sirius S		01.59	12.63		83.6103-0500.3	330230			L=500	
	Sirius A		01.59	12.63		83.6103-0500.3	330230			L=500	
MAGIRUS LKW 100											
	100 D 7 FK/FL 100 D 8 FK/FL 100 D 9 FL		01.66 01.66 01.67	12.68 12.68 12.68		83.6103-0300.3	330223			L=300	
	100 D 7 FS 100 D 8 FS		01.67 01.67	12.68 12.68		83.6103-0400.3	330226			L=400	
	100 D 7 FA 100 D 8 FA 100 D 9 FA		01.66 01.66 01.67	12.68 12.68 12.68		83.6103-0550.3	330231			L=550	
	100 D 6 FAL 100 D 7 FK/FL/FS 100 D 8 FK/FL/FS 100 D 9 FL		01.66 01.66 01.66 01.67	12.68 12.68 12.68 12.68		83.6103-0450.3	330228			L=450	
	100 D 7 FA 100 D 8 FA 100 D 9 FA		01.66 01.66 01.67	12.68 12.68 12.68		83.6103-0550.3	330231			L=550	
	100 D 8 FA 100 D 9 FA		01.66 01.67	12.68 12.68		83.6103-0500.3	330230	<input type="checkbox"/>		L=500	
	100 M 6 FAL					24.2423-0905.3	030070			Gz 23,81	
	100 M 6 FAL					24.2538-0901.3	040056			Nz 38,10	
MAGIRUS LKW 110											
	110 D 7 FL 110 D 9 FL		01.68 01.68	12.71 12.71		03.3134-0300.3	010308		separater Behälter ¹⁾	Hz 34,92	ATE
	110 D 7 FA 110 D 7 FK/FL 110 D 7 FL		01.68 01.68 01.68	12.71 12.71 + Hz 38,10 ²⁾ 12.71 + Hz 34,92 ³⁾		83.6103-0550.3	330231			L=550	
	110 D 7 FS 110 D 8 FK/FL 110 D 9 FL		01.68 01.69 01.68	12.71 12.71 12.71		83.6103-0300.3	330223			L=300	
	110 D 7 FS 110 D 8 FK/FL		01.68 01.69	12.71 12.71		83.6103-0600.3	330233			L=600	
	110 D 9 FL		01.68	12.71		83.6103-0650.3	330235			L=650	

¹⁾ separate reservoir / serbatoio separato / réservoir séparé / depósito independiente

²⁾ + MC 38,10 / + PF 38,10 / + MC 38,10 / + CM 38,10

³⁾ + MC 34,92 / + PF 34,92 / + MC 34,92 / + CM 34,92

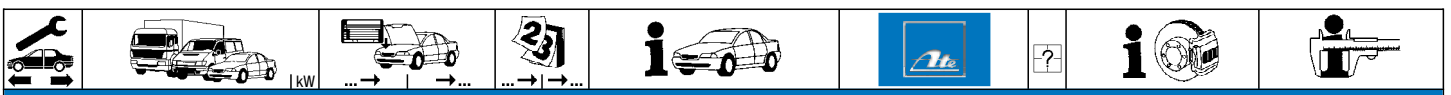

MAGIRUS LKW 110

	110 D 7 FA/FK/FL		01.68	12.71	83.6103-0500.3	330230		L=500
	110 D 7 FL		01.68	12.71 + Hz 34,92 ¹⁾	83.6103-0550.3	330231		L=550
	110 D 7 FS		01.68	12.71	83.6103-0500.3	330230		L=500
	110 D 8 FK/FL		01.69	12.71				
	110 D 9 FL		01.68	12.71	83.6103-0550.3	330231		L=550
	110 D 11 F		01.68	12.71	83.6103-0650.3	330235		L=650
	110 D 9 FL		01.68	12.71	83.6103-0550.3	330231		L=550

MAGIRUS LKW 120

	120 D 9 FG/FGB		01.74	12.75	03.0370-1131.2	051131		Hz Reparatursatz
	120 D 11 FL		01.69	12.73 + 1-Kreis-Bremse ²⁾	03.3134-0300.3	010308		Hz 34,92 ATE
	120 D 9 FL		01.72	12.73				
	120 D 11 FL		01.69	12.73 + 2-Kreis-Bremse ³⁾	03.0370-1131.2	051131		Hz Reparatursatz
	120 D 12 AK/K		01.69	12.74 + 1-Kreis-Bremse ²⁾	03.0370-1131.2	051131		Hz Reparatursatz
	120 D 13 L		01.69	12.74				
	120 D 13 FL		01.69	12.73	03.0370-1131.2	051131		Hz Reparatursatz
	120 D 7 FA		01.71	12.75 + 1-Kreis-Bremse ²⁾	83.6103-0620.3	330234		L=620
	120 D 7 FA		01.71	12.75 + 2-Kreis-Bremse ³⁾	83.6103-0650.3	330235		L=650
	120 D 7 FGB		01.74	12.75				
	120 D 7 FK/FL/FS		01.71	12.75				
	120 D 8 FK/FL							
	120 D 9 FG/FGB		01.74	12.75	83.6103-0600.3	330233		L=600
	120 D 11 FL		01.69	12.73	83.6103-0650.3	330235		L=650
	120 D 9 FL		01.72	12.73				
	120 D 12 AK/K		01.69	12.74 + HA-Rz 38,10 ⁴⁾	83.6103-0550.3	330231		L=550
	120 D 12 AK/K		01.69	12.74 + HA-Rz 34,92 ⁵⁾	83.6103-0650.3	330235		L=650
	120 D 13 FL		01.69	12.73				
	120 D 13 L		01.69	12.74				
	120 D 7 FA		01.71	12.75	83.6103-0500.3	330230		L=500
	120 D 7 FGB		01.74	12.75				
	120 D 7 FK/FL/FS		01.71	12.75				
	120 D 8 FK/FL							
	120 D 9 FG/FGB		01.74	12.75	83.6103-0300.3	330223		L=300
					83.6103-0600.3	330233		L=600
	120 D 11 FL		01.69	12.73	83.6103-0550.3	330231		L=550
	120 D 12 AK/K		01.69	12.74				
	120 D 13 FL		01.69	12.73				
	120 D 13 L		01.69	12.74				
	120 D 9 FL		01.72	12.73				
	120 D 11 FL		01.69	12.73	83.6103-0550.3	330231		L=550
	120 D 12 AK/K		01.69	12.72				
	120 D 13 FL		01.69	12.73				
	120 D 13 L		01.69	12.72				
	120 D 9 FL		01.72	12.73				

MAGIRUS LKW 126

	126 D 11 A/AK/L		01.64	12.67	03.0370-1131.2	051131		Hz Reparatursatz
	126 D 11 FL/FS		01.64	12.67				
	126 D 12 L		01.65	12.67				
	126 D 11 A/AK/L		01.64	12.67	83.6103-0550.3	330231		L=550
	126 D 11 FL/FS		01.64	12.67	83.6103-0500.3	330230		L=500
	126 D 13 F		01.66	12.67	83.6103-0400.3	330226		L=400
	126 D 14 F		01.66	12.67				
	126 D 11 A/AK/L		01.64	12.67	83.6103-0550.3	330231		L=550
	126 D 11 FL/FS		01.64	12.67	83.6103-0300.3	330223		L=300
	126 D 13 F		01.66	12.67	83.6103-0550.3	330231		L=550
	126 D 14 F		01.66	12.67	83.6103-0500.3	330230	■	L=500

MAGIRUS LKW 130

	130 D 7 FA/FAL		01.72	12.74	03.0370-1131.2	051131		Hz Reparatursatz
	130 D 8 FA		01.72	12.74				
	130 D 9 AL		01.72	12.74	03.3134-0300.3	010308		Hz 34,92 ATE
					03.0370-1131.2	051131	+ Hz 31,75 ⁶⁾	Hz Reparatursatz
	130 D 9 FA		01.72	12.74	03.0370-1131.2	051131		Hz Reparatursatz
	130 D 11 FL		01.73	12.76 + 1-Kreis-Bremse ²⁾	03.3134-0300.3	010308		Hz 34,92 ATE
	130 D 9 FL		01.73	12.76				
	130 D 11 FL		01.73	12.76 + 2-Kreis-Bremse ³⁾	03.0370-1131.2	051131		Hz Reparatursatz
	130 D 12 AK		01.73	12.82 + 1-Kreis-Bremse ²⁾	03.0370-1131.2	051131		Hz Reparatursatz
	130 D 12 K		01.73	12.80 + 1-Kreis-Bremse ²⁾				
	130 D 12 AK		01.73	12.82 + 2-Kreis-Bremse ³⁾	03.3134-0300.3	010308	2	Hz 34,92 ATE
	130 D 12 K		01.73	12.80 + 2-Kreis-Bremse ³⁾				
	130 D 13 AK/F		01.72	12.82	03.3134-0300.3	010308		Hz 34,92 ATE
	130 D 13 L		01.72	12.82 + 1-Kreis-Bremse ²⁾	03.0370-1131.2	051131		Hz Reparatursatz
	130 D 13 LH/LHD		01.72	12.82				
	130 D 13 L		01.72	12.82 + 2-Kreis-Bremse ³⁾	03.0370-1131.2	051131		Hz Reparatursatz
	130 D 14 FL		01.74	12.80				
	130 M 7 FAL		01.75	12.82				
	130 M 8 FAL		01.75	12.82				

1) + MC 34,92 / + PF 34,92 / + MC 34,92 / + CM 34,92
 2) + single circuit brake / + impianto freni circuito singolo / + frein à 1 circuit / + freno de 1 circuito
 3) + two circuit brake / + impianto frenante doppio circuito / + frein à deux circuits / + freno de 2 circuitos
 4) + RA WC 38,10 / + P CR 38,10 / + ess. AR CR 38,10 / + ET CR 38,10
 5) + RA WC 34,92 / + P CR 34,92 / + ess. AR CR 34,92 / + ET CR 34,92
 6) + MC 31,75 / + PF 31,75 / + MC 31,75 / + CM 31,75



MAGIRUS LKW 130										
	130 M 7 FAL		01.75	12.82		03.3138-2001.3	010310	+ Hinterachse ¹⁾	Hz 38,10	ATE
	130 M 8 FAL		01.75	12.82		03.0370-1131.2	051131	+ Vorderachse ²⁾	Hz Reparatursatz	
						03.0370-1038.2	051038	+ Hinterachse ¹⁾	Hz Reparatursatz	
						03.0370-9998.2	059998	+ Hinterachse ¹⁾	Hz Rep. Satz, -Kolben	
	130 M 8 FK/FL/FS		01.75	12.82		03.3138-2001.3	010310		Hz 38,10	ATE
						03.0370-1038.2	051038		Hz Reparatursatz	
						03.0370-9998.2	059998		Hz Rep. Satz, -Kolben	ATE
	130 M 9 FA		01.72	12.74		03.0370-1131.2	051131		Hz Reparatursatz	
	130 M 13 L		01.72	12.74		03.0370-1131.2	051131		Hz Reparatursatz	
	130 D 7 FA		01.72	12.74		83.6103-0450.3	330228		L=450	
	130 D 8 FA		01.72	12.74		83.6103-0550.3	330231		L=550	
	130 D 8 FK/FL		01.72	12.74		83.6103-0650.3	330235		L=650	
	130 D 9 AL		01.72	12.74	+ Hz 31,75 ³⁾					
	130 D 9 FA		01.72	12.74		83.6103-0550.3	330231		L=550	
	130 D 11 FL		01.73	12.76		83.6103-0650.3	330235		L=650	
	130 D 12 AK/K		01.73	12.82						
	130 D 9 FGB		01.72	12.74						
	130 D 9 FK/FL		01.75	12.76						
	130 D 13 F		01.72	12.82		83.6103-0650.3	330235		L=650	
	130 D 13 L/LH/LHD		01.72	12.82						
	130 D 14 FL		01.74	12.80						
	130 M 8 FK/FL/FS		01.75	12.82						
	130 M 9 FA		01.72	12.74		83.6103-0550.3	330231		L=550	
	130 M 11 FG/FGB		01.76	12.82		83.6103-0650.3	330235		L=650	
	130 M 13 L		01.72	12.74						
	130 M 9 FG/FGB		01.76	12.82						
	130 M 9 FK/FL/FS		01.75	12.82						
	130 D 7 FA		01.72	12.74		83.6103-0620.3	330234		L=620	
	130 D 7 FAL		01.72	12.74		83.6103-0450.3	330228		L=450	
	130 D 8 FA		01.72	12.74		83.6103-0550.3	330231		L=550	
	130 D 8 FK/FL		01.72	12.74		83.6103-0620.3	330234	■	L=620	
	130 D 9 AL/FA		01.72	12.74		83.6103-0550.3	330231		L=550	
	130 D 9 FK/FL		01.75	12.76	+ HA-Rz 44,45 ⁴⁾	83.6103-0620.3	330234	■	L=620	
	130 D 11 FL		01.73	12.76		83.6103-0550.3	330231		L=550	
	130 D 12 AK/K		01.73	12.82						
	130 D 9 FL		01.75	12.76	+ HA-Rz 28,57/31,75 ⁵⁾					
	130 D 13 L/LH/LHD		01.72	12.82		83.6103-0550.3	330231		L=550	
	130 D 14 FL		01.74	12.80						
	130 M 7 FAL		01.75	12.82		83.6103-0450.3	330228		L=450	
	130 M 8 FAL		01.75	12.82						
	130 M 8 FK/FL/FS		01.75	12.82		83.6103-0620.3	330234		L=620	
	130 M 9 FA		01.72	12.82		83.6103-0550.3	330231		L=550	
	130 M 9 FK/FL/FS		01.75	12.82		83.6103-0620.3	330234	■	L=620	
	130 M 11 FK/FL		01.75	12.82		83.6103-0620.3	330234		L=620	
130 M 13 FK/FL		01.75	12.82							
	130 D 7 FAL		01.72	12.74		24.2423-0905.3	030070		Gz 23,81	
	130 D 8 FK/FL		01.72	12.74						
	130 D 9 FGB		01.72	12.75						
	130 D 9 FK		01.72	12.76						
	130 M 7 FAL		01.75	12.82		24.2423-0905.3	030070		Gz 23,81	
	130 M 8 FAL/FL		01.75	12.82						
	130 M 8 FK/FS		01.75	12.82						
130 M 11 FG/FGB		01.75	12.82		24.2423-0905.3	030070		Gz 23,81		
130 M 11 FK/FL		01.75	12.82							
130 M 13 FK/FL		01.75	12.82							
130 M 9 FG/FGB		01.75	12.82							
130 M 9 FK/FL/FS		01.75	12.82							
	130 D 7 FAL		01.72	12.74		24.2538-0901.3	040056		Nz 38,10	
	130 D 8 FK/FL		01.72	12.74						
	130 D 9 FGB		01.72	12.75						
	130 D 9 FK		01.72	12.76						
	130 M 7 FAL		01.75	12.82		24.2538-0901.3	040056		Nz 38,10	
	130 M 8 FAL/FL		01.75	12.82						
	130 M 8 FK/FS		01.75	12.82						
	130 M 11 FG/FGB		01.75	12.82		24.2538-0901.3	040056		Nz 38,10	
130 M 11 FK/FL		01.75	12.82							
130 M 13 FK/FL		01.75	12.82							
130 M 9 FG/FGB		01.75	12.82							
130 M 9 FK/FL/FS		01.75	12.82							
	130 D 11 FL		01.72	12.72		83.6103-0550.3	330231		L=550	
	130 D 12 AK/K		01.72	12.72						
	130 D 13 AK		01.72	12.72						
	130 D 13 F		01.72	12.82						
	130 D 13 L/LH/LHD		01.72	12.72						
	130 D 14 FL		01.72	12.80						
	130 D 15 AK/K		01.72	12.72						
	130 D 16 FL		01.72	12.80						
	130 D 16 FLL		01.72	12.76						
	130 D 16 L		01.72	12.72						
	130 D 9 AL		01.72	12.72						
	130 D 9 FL		01.73	12.76						

1) + rear axle / + asse posteriore / + essieu arrière / + eje trasero

2) + front axle / + asse anteriore / + essieu avant / + eje delantero

3) + MC 31,75 / + PF 31,75 / + MC 31,75 / + CM 31,75

4) + RA WC 44,45 / + P CR 44,45 / + ess. AR CR 44,45 / + ET CR 44,45

5) + RA WC 28,57/31,75 / + P CR 28,57/31,75 / + ess. AR CR 28,57/31,75 / + ET CR 28,57/31,75

MAGIRUS LKW 130									
	130 M 13 L		01.72	12.72		83.6103-0550.3	330231		L=550
MAGIRUS LKW 135									
	135 D 12 FBP/L		01.66	12.70		03.0370-1131.2	051131		Hz Reparatursatz
	135 D 14 AK		01.71	12.72		03.3134-0300.3	010308		Hz 34,92 ATE
	135 D 11 FS		01.66	12.70		83.6103-0300.3	330223		L=300
	135 D 12 FBP		01.66	12.70		83.6103-0550.3	330231		L=550
	135 D 12 L		01.66	12.70		83.6103-0550.3	330231		L=550
	135 D 13 AK		01.66	12.70		83.6103-0300.3	330223		L=300
						83.6103-0550.3	330231		L=550
	135 D 14 AK		01.71	12.72		83.6103-0650.3	330235		L=650
	135 D 14 F		01.71	12.72		83.6103-0300.3	330223		L=300
						83.6103-0550.3	330231		L=550
	135 D 11 FS		01.66	12.70		83.6103-0500.3	330230		L=500
	135 D 12 FBP		01.66	12.70					
	135 D 12 L		01.66	12.70		83.6103-0550.3	330231		L=550
	135 D 13 AK		01.66	12.70		83.6103-0500.3	330230		L=500
	135 D 14 F		01.71	12.72					
	135 M 14 FL		01.77	12.82		24.2538-0901.3	040056		Nz 38,10
	135 D 11 FS		01.66	12.70		24.2538-0901.3	040056		Nz 38,10
	135 D 12 FBP		01.66	12.70					
	135 D 13 AK		01.66	12.70					
	135 D 14 AK/F		01.71	12.72					
	135 D 13 AK		01.66	12.70		83.6103-0550.3	330231		L=550
	135 D 14 AK		01.71	12.72		83.6103-0650.3	330235		L=650
MAGIRUS LKW 140/150									
	150 D 10 A					03.0370-1131.2	051131		Hz Reparatursatz
	150 D 11/AK/FA/L								
	150 D 12								
	140 D 11 AL					83.6103-0650.3	330235		L=650
	150 D 10 A					83.6103-0550.3	330231		L=550
	150 D 11/AK/FA/L								
	150 D 12								
	150 D 14 AK/L		01.65	12.67					
	140 D 11 AL					83.6103-0550.3	330231		L=550
	150 D 10 A					83.6103-0550.3	330231		L=550
	150 D 11/AK/FA/L								
	150 D 12								
	150 D 14 AK/L		01.65	12.67					
MAGIRUS LKW 160/168									
	160 D 11 FL		01.72	12.76		03.0370-1131.2	051131		Hz Reparatursatz
	160 D 11 FS		01.72	12.76		03.3138-2001.3	010310		Hz 38,10 ATE
						03.0370-1038.2	051038		Hz Reparatursatz
						03.0370-9998.2	059998		Hz Rep. Satz, -Kolben ATE
	160 D 12 AK		01.72	12.82 + 1-Kreis-Bremse ¹⁾		03.0370-1131.2	051131		Hz Reparatursatz
	160 D 12 AK		01.72	12.82 + 2-Kreis-Bremse ²⁾		03.3134-0300.3	010308	2	Hz 34,92 ATE
						03.0370-1131.2	051131		Hz Reparatursatz
									+ Hz 31,75 ³⁾
	160 D 12 K		01.72	12.82 + 1-Kreis-Bremse ¹⁾		03.0370-1131.2	051131		Hz Reparatursatz
	160 D 12 K		01.72	12.80 + 2-Kreis-Bremse ²⁾		03.3134-0300.3	010308		Hz 34,92 ATE
	160 D 13 L/S					03.0370-1131.2	051131		Hz Reparatursatz
	160 D 15 K		01.72	12.82					
	160 M 13 FL/FS		01.81	12.82		03.3134-0300.3	010308		Hz 34,92 ATE
	168 M 11 FAL 4x4		01.80	12.82					
	168 M 11 FL		01.80	12.82		03.3138-2001.3	010310	2	Hz 38,10 ATE
						03.0370-1038.2	051038		Hz Reparatursatz
						03.0370-9998.2	059998		Hz Rep. Satz, -Kolben ATE
	160 D 11 FL/FS		01.72	12.76		83.6103-0650.3	330235		L=650
	160 D 12 AK/K		01.72	12.82					
	160 D 13 L/S								
	160 D 15 K		01.72	12.82					
	160 M 11 FS		01.75	12.82					
	160 M 13 FGB/FS		01.75	12.82					
	168 M 11 FAL 4x4		01.80	12.82		83.6103-0700.3	330236		L=700
	168 M 11 FL		01.80	12.82		83.6103-0550.3	330231		L=550
						83.6103-0650.3	330235		L=650
	160 D 11 FL/FS		01.72	12.76		83.6103-0550.3	330231		L=550
	160 D 12 AK/K		01.72	12.82		83.6103-0550.3	330231		L=550
	160 D 13 L/S					83.6103-0550.3	330231		L=550
	160 D 15 K		01.72	12.82					
	160 M 8 FAL		01.75	12.82		83.6103-0450.3	330228		L=450

¹⁾ + single circuit brake / + impianto freni circuito singolo / + frein à 1 circuit / + freno de 1 circuito
²⁾ + two circuit brake / + impianto frenante doppio circuito / + frein à deux circuits / + freno de 2 circuitos
³⁾ + MC 31,75 / + PF 31,75 / + MC 31,75 / + CM 31,75

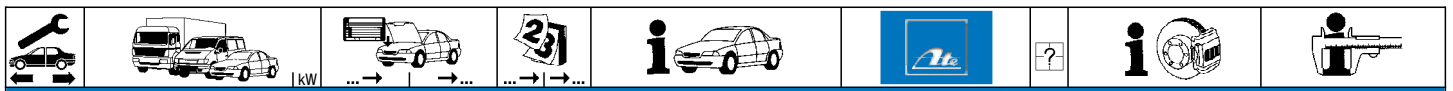

MAGIRUS LKW 160/168

	160 M 11 FK/FL		01.75	12.82	24.2423-0905.3	030070			Gz 23,81
	160 M 11 FLL/FS		01.75	12.82					
	160 M 13 FGB/FK/FL		01.75	12.82					
	160 M 13 FLL/FS		01.75	12.82					
	160 M 8 FAL/FL		01.75	12.82					
	168 M 11 FAL 4x4		01.80	12.82	24.2423-0905.3	030070			Gz 23,81
	168 M 11 FL		01.80	12.82					
	160 M 11 FK/FL		01.75	12.82	24.2538-0901.3	040056			Nz 38,10
	160 M 11 FLL/FS		01.75	12.82					
	160 M 13 FGB/FK/FL		01.75	12.82					
	160 M 13 FLL/FS		01.75	12.82					
	160 M 8 FAL/FL		01.75	12.82					
	168 M 11 FAL 4x4		01.80	12.82	24.2538-0901.3	040056			Nz 38,10
	168 M 11 FL		01.80	12.82					
	160 D 11 FL		01.72	12.72	83.6103-0550.3	330231			L=550
	160 D 11 FS		01.72	12.73					
	160 D 12 AK/FL/K		01.72	12.72					
	160 D 15 AK/K		01.72	12.72					
	160 D 15 FAK		01.72	12.72					
	160 D 16 FL/FLL		01.74	12.82					
	160 D 16 FLG		01.72	12.72					
	160 D 16 L		01.72	12.72					

MAGIRUS LKW 170

	170 D 10 AK/FA				03.0370-1131.2	051131			Hz Reparatursatz						
	170 D 11 A/FL		01.71	12.80	03.0370-1131.2	051131			Hz Reparatursatz						
	170 D 11 F/FA		01.71	12.80	03.0370-1131.2	051131			Hz Reparatursatz						
	170 D 11 FAL/FL		01.71	12.80	03.0370-1131.2	051131			Hz Reparatursatz						
	170 D 12 A/AL		01.69	12.82	03.0370-1131.2	051131			Hz Reparatursatz						
	170 D 12 AK		01.69	12.82	+ 1-Kreis-Bremse ¹⁾	03.0370-1131.2	051131		Hz Reparatursatz						
	170 D 12 AK		01.69	12.82	+ 2-Kreis-Bremse ²⁾	03.3134-0300.3	010308	2	Hz 34,92						
	170 D 12 F		01.69	12.82	+ 1-Kreis-Bremse ¹⁾	03.0370-1131.2	051131		Hz Reparatursatz						
	170 D 12 K		01.69	12.82											
	170 D 13 FA/FS		01.69	12.73											
	170 D 13 FK/FL		01.69	12.73		03.0370-1131.2	051131		Hz Reparatursatz						
	170 D 14 F/FL		01.73	12.80											
	170 D 14 FS		01.73	12.80		03.3134-0300.3	010308	2	Hz 34,92						
						03.0370-1131.2	051131		+ Hz 31,75 ³⁾						
		170 D 15 AK/FA/FAK		01.69	12.82	03.3134-0300.3	010308			Hz 34,92					
170 D 15 FK/FL/K			01.69	12.82											
170 D 16 FAK			01.70	12.82											
170 D 17 AK/K															
170 D 17 F/FL															
170 D 21 AK		01.69	12.72		03.3134-0300.3	010308	2	Hz 34,92							
					03.0370-1131.2	051131		+ Hz 31,75 ³⁾							
170 D 22 FL					03.0370-1131.2	051131		Hz Reparatursatz							
170 M 14 FS					03.3134-0300.3	010308		Hz 34,92							
					03.0370-1131.2	051131		ATE							
	170 D 10 AK/FA				83.6103-0650.3	330235			L=650						
	170 D 11 A/FL/FAL		01.71	12.80											
	170 D 11 F/FA		01.71	12.80											
	170 D 12 A/AL		01.69	12.82											
	170 D 12 AK/F		01.69	12.82											
	170 D 12 K		01.69	12.82											
	170 D 13 FA/FK		01.69	12.73											
	170 D 13 FL/FS		01.69	12.73											
	170 D 14 F/FL/FS		01.73	12.80											
	170 D 15 AK/FA/FAK		01.69	12.82											
	170 D 15 FK/FL/K		01.69	12.82											
	170 D 16 FAK		01.70	12.82											
	170 D 17 AK/F/FL														
	170 D 17 FL/K														
	170 D 19 F/FL														
170 M 14 FS					83.6103-0650.3	330235		L=650							
	170 D 10 AK/FA				83.6103-0550.3	330231			L=550						
	170 D 11 A/F/FA		01.71	12.80											
	170 D 11 FL/FAL		01.71	12.80											
	170 D 12 A/AK/AL/F		01.69	12.82											
	170 D 12 K		01.69	12.82											
	170 D 13 FA/FK/FL		01.69	12.73											
	170 D 14 F/FL		01.73	12.80											
	170 D 14 FS		01.73	12.80											
											83.6103-0550.3	330231		L=550	
											83.6103-0550.3	330235		+ Hz 34,92 ⁴⁾	
	170 D 15 K		01.69	12.82							83.6103-0650.3	330235		L=650	
	170 D 21 AK		01.69	12.72											
	170 D 22 FL														
		170 D 10 AK									83.6103-0550.3	330231			L=550
		170 D 11 A													
170 D 11 F/FA			01.71	12.80											

1) + single circuit brake / + impianto freni circuito singolo / + frein à 1 circuit / + freno de 1 circuito
2) + two circuit brake / + impianto frenante doppio circuito / + frein à deux circuits / + freno de 2 circuitos
3) + MC 31,75 / + PF 31,75 / + MC 31,75 / + CM 31,75
4) + MC 34,92 / + PF 34,92 / + MC 34,92 / + CM 34,92



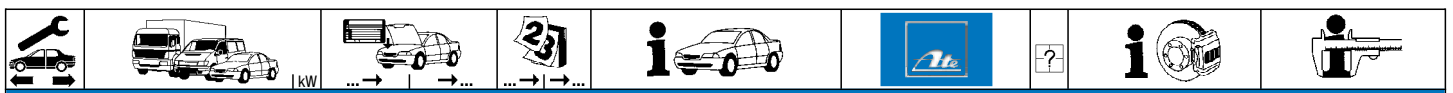

MAGIRUS LKW 232

	232 D 15 FA/FAK	01.69	12.82	03.3134-0300.3	010308			Hz 34,92	ATE						
	232 D 15 FK/FL/FS	01.70	12.82												
	232 D 16 A/AK/AL	01.69	12.72												
	232 D 16 FAK	01.69	12.82												
	232 D 17 FA/FAK	01.69	12.80												
	232 D 17 FK/FS	01.69	12.80												
	232 D 19 AK/FAK	01.69	12.80 + 1-Kreis-Bremse ¹⁾												
	232 D 19 FAK	01.69	12.80 + 2-Kreis-Bremse ²⁾												
	232 D 19 FS	01.69	12.80												
	232 D 20 AL	01.69	12.80												
	232 D 20 FAL	01.69	12.80							03.3134-0300.3	010308		+ Hz 31,75 ³⁾	Hz 34,92	ATE
										03.0370-1131.2	051131				
	232 D 22 AK	01.69	12.76							03.3134-0300.3	010308		+ Vorderachse ⁴⁾ + Hinterachse ⁵⁾	Hz 34,92	ATE
	232 D 22 FAK	01.69	12.77							03.3134-0300.3	010308	2		Hz 34,92	ATE
	232 D 22 FB	01.72	12.76							03.3134-0300.3	010308	2		Hz 34,92	ATE
	232 D 22 FK	01.69	12.77 + 1-Kreis-Bremse ¹⁾							03.3134-0300.3	010308			Hz 34,92	ATE
01.69				12.77 + 2-Kreis-Bremse ²⁾											
232 D 22 FL/FS	01.69	12.71	03.3134-0300.3	010308			Hz 34,92	ATE							
									01.72	12.76					
232 D 22 K	01.69	12.78													
	232 D 13 FL/FS	01.73	12.80	83.6103-0650.3	330235			L=650							
	232 D 14 FL/FS	01.73	12.80												
	232 D 15 FK/FL/FS	01.70	12.82												
	232 D 17 FS	01.69	12.80												
	232 D 19 FAK	01.69	12.80 + 2-Kreis-Bremse ²⁾	83.6103-0650.3	330235			L=650							
	232 D 13 FL/FS	01.73	12.80												
	232 D 14 FL/FS	01.73	12.80	83.6103-0550.3	330231			L=550							
	232 D 15 FK	01.70	12.82												
	232 D 19 FS	01.69	12.80	83.6103-0650.3	330235			L=650							
	232 D 20 FAL	01.69	12.80												
	232 D 22 AK/FAK/FK	01.69	12.77												
	232 D 22 FB/K	01.72	12.76												
	232 D 22 FL/FS	01.69	12.71												
	232 D 26 K	01.69	12.78												
		232 D 15 FL	01.69						12.72	83.6103-0550.3	330231			L=550	
		232 D 16 A/AK/AL/K	01.69						12.72						
		232 D 16 FAK	01.69						12.72						
		232 D 19 AK/FAK/K	01.69						12.72						
		232 D 19 L	01.69						12.72						
		232 D 19 S	01.69						12.72						
		232 D 20 AL	01.70						12.72						
	232 D 22 AK	01.69	12.72	83.6103-0650.3	330235			L=650							
	232 D 22 FAK/FK	01.69	12.77 + Gz 19,05 ⁶⁾												
	232 D 22 FB	01.72	12.76 + Gz 19,05 ⁶⁾												
	232 D 22 K	01.69	12.72												
	232 D 24 L	01.70	12.72												
	232 D 26 AK	01.73	12.78 + Gz 19,05 ⁶⁾												
	232 D 26 AK/FK	01.69	12.72												
	232 D 26 F/FK	01.73	12.80 + Gz 19,05 ⁶⁾												
	232 D 26 K/L/S	01.69	12.72												
	232 D 32 AK/K	01.69	12.72												

MAGIRUS LKW 250/260

	256 D 19 L	01.77	12.82	03.3134-0300.3	010308			Hz 34,92	ATE	
	260 D 16 FAL									03.0370-1131.2
	250 D 22 FL	01.66	12.72	83.6103-0400.3	330226			L=400 L=650		
	256 D 19 L	01.77	12.82						83.6103-0650.3	330235
	250 D 22 FL	01.66	12.72	83.6103-0650.3	330235			L=650		
	260 D 16 FAL								83.6103-0650.3	330235
	250 D 22 FL	01.66	12.72	83.6103-0550.3	330231			L=550 L=650		
	256 D 16 FS	01.77	12.80 + Gz 19,05 ⁶⁾						83.6103-0400.3	330226
	256 D 19 L	01.75	12.78						83.6103-0550.3	330231
	256 D 22 FLL	01.77	12.80						83.6103-0550.3	330231

MAGIRUS LKW 270

	270 D 16 AK	01.72	12.79	03.3134-0300.3	010308			Hz 34,92	ATE
	270 D 22 FL/FLL	01.72	12.82						
	270 D 22 FS/FSL	01.76	12.82						
	270 D 22 FL/FS	01.72	12.82	83.6103-0650.3	330235			L=650	
	270 D 22 FLL/FSL	01.72	12.82						83.6103-0400.3
	270 D 22 FS		12.72	83.6103-0650.3	330235			L=650	

¹⁾ + single circuit brake / + impianto freni circuito singolo / + frein à 1 circuit / + freno de 1 circuito
²⁾ + two circuit brake / + impianto frenante doppio circuito / + frein à deux circuits / + freno de 2 circuitos
³⁾ + MC 31,75 / + PF 31,75 / + MC 31,75 / + CM 31,75
⁴⁾ + front axle / + asse anteriore / + essieu avant / + eje delantero
⁵⁾ + rear axle / + asse posteriore / + essieu arrière / + eje trasero
⁶⁾ + CC 19,05 / + CC 19,05 / + EE 19,05 / + CTR 19,05













MAGIRUS LKW 290													
	290 D 15 FS		01.70	12.71		03.3134-0300.3	010308			Hz 34,92	ATE		
	290 D 22 FK		01.69	12.72		03.0370-1131.2	051131			Hz Reparatursatz			
	290 D 15 FS		01.70	12.71		83.6103-0650.3	330235			L=650			
	290 D 22 FK		01.69	12.72		83.6103-0650.3	330235			L=650			
	290 D 15 FS		01.70	12.71		83.6103-0500.3	330230			L=500			
	290 D 22 FK		01.69	12.72		83.6103-0550.3	330231			L=550			
	290 D 26 K			12.72	+ Nz 34,92 ¹⁾	83.6103-0550.3	330231			L=550			
	290 D 26 S					83.6103-0650.3	330235			L=650			
	290 D 26 K				+ Nz 38,10 ²⁾	83.6103-0550.3	330231			L=550			
						83.6103-0620.3	330234			L=620			
MAGIRUS LKW 310													
	310 D 15 FL/FS		01.71	12.75		03.3134-0300.3	010308			Hz 34,92	ATE		
	310 D 16 AK/FAK/FK		01.72	12.82									
	310 D 16 FSL		01.72	12.80		03.0370-1131.2	051131			Hz Reparatursatz			
	310 D 19 AK			12.82		03.3134-0300.3	010308			Hz 34,92	ATE		
	310 D 19 FAK/FL												
	310 D 20 AL					03.0370-1131.2	051131			Hz Reparatursatz			
	310 D 22 AK/K/FK		01.71	12.76		03.3134-0300.3	010308			Hz 34,92	ATE		
	310 D 22 FA/FAK		01.73	12.80									
	310 D 22 FL/FLL		01.71	12.82									
	310 D 22 FS/FSL		01.71	12.82									
	310 D 26 AK/FK		01.73	12.82									
	310 D 26 AS		01.72	12.82									
	310 D 26 K		01.76	12.82									
	310 D 31 AS		01.72	12.82		03.0370-1131.2	051131			Hz Reparatursatz			
	310 D 15 FL/FS		01.71	12.75		83.6103-0650.3	330235			L=650			
	310 D 16 FAK/FK		01.72	12.82		83.6103-0650.3	330235			L=650			
	310 D 16 FSL		01.72	12.80									
	310 D 31 AS		01.72	12.82		83.6103-0650.3	330235			L=650			
	310 D 16 FSL		01.72	12.80		83.6103-0550.3	330231			L=550			
	310 D 19 FL					83.6103-0650.3	330235			L=650			
	310 D 22 FL/FS		01.71	12.82									
	310 D 22 K/FK		01.71	12.76									
	310 D 22 FLL/FSL		01.71	12.82		83.6103-0400.3	330226			L=400			
	310 D 22 AK/FA/FAK		01.72	12.80		83.6103-0650.3	330235			L=650			
	310 D 26 FK		01.73	12.82									
	310 D 31 AS		01.72	12.82		83.6103-0550.3	330231			L=550			
	310 D 16 AK			12.72		83.6103-0550.3	330231			L=550			
						83.6103-0650.3	330235			L=650			
	310 D 16 FL		01.72	04.73		83.6103-0550.3	330231			L=550			
	310 D 16 FL		05.73	12.82		83.6103-0550.3	330231			L=550			
	310 D 19 AK			12.72		83.6103-0550.3	330231			L=550			
	310 D 22 FS/K			12.72		83.6103-0650.3	330235			L=650			
	310 D 26 AS			12.72									
	310 D 31 AS			12.72		83.6103-0550.3	330231			L=550			
MAGIRUS LKW 340													
	340 D 22 FL/FLL		01.70	12.76		03.3134-0300.3	010308			Hz 34,92	ATE		
	340 D 22 FS/FSL		01.70	12.76									
	340 D 22 FL		01.70	12.76		83.6103-0650.3	330235			L=650			
	340 D 22 FLL		01.70	12.76		83.6103-0400.3	330226			L=400			
	340 D 22 FS/FSL		01.70	12.76									
MAGIRUS LKW 70/75													
	75 D 6 FL		01.67	12.69		03.3131-0102.3	010296			Hz 31,75	ATE		
	70 D 6 FL		01.67	12.69		83.6103-0550.3	330231			L=550			
	75 D 6 FL		01.67	12.69		83.6103-0550.3	330231			L=550			
	70 D 6 FL		01.67	12.69		83.6103-0550.3	330231			L=550			
	75 D 6 FL		01.67	12.69		83.6103-0550.3	330231			L=550			
MAGIRUS LKW 80													
	80 D 6 FL		01.68	12.75		03.3131-0102.3	010296			Hz 31,75	ATE		
	80 D 6 FK/FL		01.68	12.75		83.6103-0550.3	330231			L=550			
						83.6103-0650.3	330235			L=650			
	80 D 6 FLU		01.68	12.75		83.6103-0650.3	330235			L=650			
	80 D 7 FK/FL		01.68	12.75									
	80 D 7 FG/FGB		01.74	12.75		83.6103-0600.3	330233			L=600			
	80 D 7 FK/FL		01.68	12.75									

¹⁾ + SC 34,92 / + C Riv 34,92 / + RE 34,92 / + CRE 34,92

²⁾ + SC 38,10 / + C Riv 38,10 / + RE 38,10 / + CRE 38,10

MAGIRUS LKW 80									
	80 D 8 FK/FL			01.68	12.70		83.6103-0600.3	330233	L=600
	80 D 6 FK/FL			01.68	12.75		83.6103-0500.3	330230	L=500 L=550
	80 D 6 FLU			01.68	12.75		83.6103-0500.3	330230	L=500
	80 D 7 FK/FL			01.68	12.75				
	80 D 7 FG/FGB			01.74	12.75		83.6103-0600.3	330233	L=600
	80 D 7 FK/FL			01.68	12.75		83.6103-0500.3	330230	L=500
	80 D 8 FK/FL			01.68	12.70				
MAGIRUS LKW 90									
	90 D 6 FK			01.65	12.66		03.0370-1131.2	051131	Hz Reparatursatz
	90 D 7 FK/FL			01.65	12.66				
	90 M 6 FL			01.75	12.82		03.3138-2001.3	010310	+ Hinterachse ¹⁾
							03.0370-1131.2	051131	+ Vorderachse ²⁾
							03.0370-1038.2	051038	+ Hinterachse ¹⁾
							03.0370-9998.2	059998	+ Hinterachse ¹⁾
	90 D 6 FK			01.65	12.66		83.6103-0650.3	330235	L=650
	90 D 7 FK/FL			01.65	12.66				
	90 D 7 L			01.64	12.66		83.6103-0500.3	330230	L=500
	90 M 6 FK/FL			01.75	12.82		83.6103-0650.3	330235	L=650
	90 M 7 FK/FL			01.75	12.82				
	90 M 8 FK/FL			01.75	12.82				
	90 M 9 FL			01.75	12.82				
	90 D 6 FK			01.65	12.66		83.6103-0550.3	330231	L=550
	90 D 7 FK/FL			01.65	12.66				
	90 D 7 L			01.64	12.66		83.6103-0500.3	330230	L=500
	90 M 6 FL			01.75	12.82		83.6103-0600.3	330233	L=600
							83.6103-0620.3	330234	L=620
	90 M 6 FK			01.75	12.82		83.6103-0620.3	330234	L=620
	90 M 7 FK/FL			01.75	12.82				
	90 M 8 FK/FL			01.75	12.82				
	90 M 9 FL			01.75	12.82				
	90 D 6 FK			01.65	12.66		24.2423-0905.3	030070	Gz 23,81
	90 D 7 FK/FL			01.65	12.66				
	90 M 6 FK/FL			01.75	12.82				
	90 M 7 FK/FL			01.75	12.82				
	90 M 8 FK/FL			01.75	12.82				
	90 M 9 FL			01.75	12.82				
	90 D 6 FK			01.65	12.66		24.2538-0901.3	040056	Nz 38,10
	90 D 7 FK/FL			01.65	12.66				
	90 M 6 FK/FL			01.75	12.82				
	90 M 7 FK/FL			01.75	12.82				
	90 M 8 FK/FL			01.75	12.82				
	90 M 9 FL			01.75	12.82				
MAN BUS 192-890									
	420 HOC 1/2			01.64			03.3131-0601.3	010299	Hz 31,75
	535 HO								ATE
	750 HO								
	535 HO						03.0370-1131.2	051131	Hz Reparatursatz
	750 H/SL/160 VÖV								
	750 HO 11 UE 192								
	750 HO 12 UE 192								
	750 HO-M 11/160								
	750 HO-V 11/160								
	750 HO-V 12/160								
	750 SUE 230								
	890 SG 192 VÖV								
	535 HO						03.3509-0600.3	310065	Behälter
	750 HO								
	750 HO-M 11/160								
	750 HO-V 11/160								
	750 HO-V 12/160								
	890 UG/UO/UOM 12 A								
	420 HOC 1/2						83.6103-0500.3	330230	L=500
	535 HO			01.64			83.6103-0260.3	330221	L=260
	750 HO								
	445 HO						03.0450-2509.2	082509	Nz Reparatursatz
	535 HO								
	640 HO 1								
	640 HO-M 11								
	750 HO-M 11/160								
	750 HO-MI-VI-RI-U								+ Differentialsperre ⁵⁾
	750 HO-U 11/12-192								
	750 HO-V 11/160								
	750 HO-V 12/160								
	750 HO/SL 160								
	750 HO/SL 176								
	750 SL 160 VÖV								
	750 SÜ								
	890 SG 192								
	890 UO-M/UG-M								+ Differentialsperre ⁵⁾

¹⁾ + rear axle / + asse posteriore / + essieu arrière / + eje trasero
²⁾ + front axle / + asse anteriore / + essieu avant / + eje delantero
³⁾ + FA WC 41,27 / + A CR 41,27 / + ess. AV CR 41,27 / + ED CR 41,27
⁴⁾ + FA WC 44,45 / + A CR 44,45 / + ess. AV CR 44,45 / + ED CR 44,45
⁵⁾ + differential lock / + differenziale autobloccante / + blocage de différentiel / + bloqueo diferencial

MAN LKW 12.168-12.215										
	12.215 H/HK/HS 12.215 HA/HKA/HSA				12.69 12.69			03.0450-2509.2	082509	Nz Reparatursatz
	12.215 H/HA/HK/HKA 12.215 HS/HSA				12.69 12.69			83.6203-0260.3	330300	L=260
MAN LKW 13.136-13.256										
	13.136 H/HA 13.168 F/FR 13.168 F/H/HA 13.192 F/H 13.192 FR 13.192 U 13.212 BF/F 13.215 DHA 13.215 F/FK/FS 13.215 H/HA/HK/HKA 13.215 HS/HSA 13.230 BF/FK/FS 13.230 DHA 13.230 H/HA/HK/HKA 13.230 HS/HSA 13.250 F/FK/FS 13.256 H/HA				01.82 01.72 01.72 01.82 01.75	12.84 12.81 12.83 12.84 12.75	Typ 523 ¹⁾ Typ 232/233/234 ²⁾ Typ 232/233 ³⁾ Typ 523 ¹⁾ Typ 901 ⁴⁾	03.0370-1131.2	051131	Hz Reparatursatz
	13.136 H/HA 13.168 F/FR 13.168 F/H/HA 13.192 F/H 13.192 FR 13.192 U 13.212 BF/F 13.215 DHA 13.215 F/FK/FS 13.215 H/HA/HK/HKA 13.215 HS/HSA 13.230 BF/FK/FS 13.230 DHA 13.230 H/HA/HK/HKA 13.230 HS/HSA 13.250 F/FK/FS 13.256 H/HA				01.82 01.72 01.72 01.82 01.75	12.84 12.81 12.83 12.84 12.75	Typ 523 ¹⁾ Typ 232/233/234 ²⁾ Typ 232/233 ³⁾ Typ 523 ¹⁾ Typ 901 ⁴⁾	03.3508-0501.3	310017	Behälter
	13.136 H/HA 13.168 F/FR 13.168 F/H/HA 13.192 F/H 13.192 FR 13.192 U 13.212 BF/F 13.215 DHA/F/FK/FS 13.215 H/HA/HK/HKA 13.215 HS/HSA 13.230 BF/DHA 13.230 F/FK/FS 13.230 H/HA/HK/HKA 13.230 HS/HSA 13.250 F/FK/FS 13.256 H/HA				01.82 01.72 01.72 01.82 01.75	12.84 12.81 12.83 12.84 12.75	Typ 523 ¹⁾ Typ 232/233/234 ²⁾ Typ 232/233 ³⁾ Typ 523 ¹⁾ Typ 901 ⁴⁾	83.6103-0650.3	330235	L=650
	13.212 BF/F 13.230 BF/F							83.6103-0260.3	330221	□ L=260
	13.212 BF/F/H 13.215 H/HK/HS 13.215 HA/HKA/HSA				12.69 12.69			03.0450-2509.2	082509	Nz Reparatursatz
	13.230 BF 13.230 H/HK/HS 13.230 HA/HKA/HSA				12.69 12.69			03.0450-2509.2	082509	Nz Reparatursatz
	13.212 BF/F/H 13.215 H/HA/HK/HKA 13.215 HS/HSA				12.69 12.69			83.6203-0260.3	330300	L=260
	13.230 BF 13.230 H/HA/HK/HKA 13.230 HS/HSA				12.69 12.69			83.6203-0260.3	330300	L=260
	14.168 F/FR 14.192 F/FR 14.192 U 14.220 F/FL				01.72 01.72 01.75 01.82	12.84 12.84 12.84 12.84	Typ 232/523 ⁵⁾ Typ 232/523 ⁵⁾ Typ 901/903 ⁶⁾ Typ 523 ¹⁾	03.0370-1131.2	051131	Hz Reparatursatz
	14.168 F/FR 14.192 F/FR 14.192 U 14.220 F/FL				01.72 01.72 01.75 01.82	12.84 12.84 12.84 12.84	Typ 232/523 ⁵⁾ Typ 232/523 ⁵⁾ Typ 901/903 ⁶⁾ Typ 523 ¹⁾	03.3508-0501.3	310017	Behälter
MAN LKW 14.168-14.220										

¹⁾ type 523 / tipo 523 / type 523 / tipo 523

²⁾ type 232/233/234 / tipo 232/233/234 / type 232/233/234 / tipo 232/233/234

³⁾ type 232/233 / tipo 232/233 / type 232/233 / tipo 232/233

⁴⁾ type 901 / tipo 901 / type 901 / tipo 901

⁵⁾ type 232/523 / tipo 232/523 / type 232/523 / tipo 232/523

⁶⁾ type 901/903 / tipo 910/903 / type 901/903 / tipo 901/903

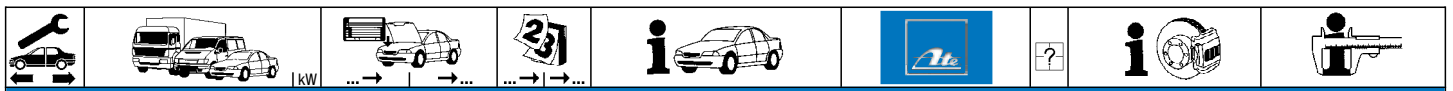

MAN LKW 14.168-14.220

	14.168 F/FR 14.192 F/FR 14.192 U 14.220 F/FL		01.72 01.72 01.75 01.82	12.84 Typ 232/523 ¹⁾ 12.84 Typ 232/523 ¹⁾ 12.84 Typ 901/903 ²⁾ Typ 523 ³⁾	83.6103-0650.3	330235		L=650
--	---	--	----------------------------------	--	----------------	--------	--	-------

MAN LKW 15.136-15.240

	15.136 F/H/HA 15.168 F/FL 15.168 H 15.168 HA/FM 15.192 F/FL 15.192 FT 15.192 H 15.192 HA 15.200 F/H 15.212 DH 15.216 F/H/HA 15.220 F/FL 15.240 F 15.240 F/FL 15.240 H 15.240 HA		01.72 01.72 01.72 01.78 01.80 01.73 01.82 01.73 01.82 01.73 01.79	12.83 Typ 237 ⁴⁾ 12.85 Typ 235/540 ⁵⁾ 12.83 Typ 237 ⁴⁾ Typ 459 ⁶⁾ Typ 540 ⁷⁾ 12.80 Typ 224/226 ⁸⁾ Typ 526 ⁹⁾ 12.83 Typ 224 ¹⁰⁾ Typ 526 ⁹⁾ Typ 226/524 ¹¹⁾ Typ 525 ¹²⁾	03.0370-1131.2	051131		Hz Reparatursatz
--	--	--	---	--	----------------	--------	--	------------------

	15.136 F/H/HA 15.168 F/FL 15.168 H 15.168 HA/FM 15.192 F/FL 15.192 FT 15.192 H 15.192 HA 15.200 F/H 15.212 DH 15.216 F/H/HA 15.220 F/FL 15.240 F 15.240 F/FL 15.240 H 15.240 HA		01.72 01.72 01.72 01.78 01.80 01.73 01.82 01.73 01.82 01.73 01.79	12.83 Typ 237 ⁴⁾ 12.85 Typ 235/540 ⁵⁾ 12.83 Typ 237 ⁴⁾ Typ 459 ⁶⁾ Typ 540 ⁷⁾ 12.80 Typ 224/226 ⁸⁾ Typ 526 ⁹⁾ 12.83 Typ 224 ¹⁰⁾ Typ 526 ⁹⁾ Typ 226/524 ¹¹⁾ Typ 525 ¹²⁾	03.3508-0501.3	310017		Behälter
--	--	--	---	--	----------------	--------	--	----------

	15.136 F/H/HA 15.168 F 15.168 F/FL 15.168 H 15.168 HA/FM 15.192 F 15.192 F/FL 15.192 FT 15.192 H 15.192 HA 15.200 F 15.212 DH 15.216 F/H/HA 15.220 F/FL 15.240 F 15.240 F/FL 15.240 H 15.240 HA		01.72 01.77 01.72 01.72 01.72 01.78 01.80 01.73 01.82 01.73 01.79 01.79	12.76 Typ 237 ⁴⁾ 12.83 Typ 237 ⁴⁾ 12.85 Typ 235/540 ⁵⁾ 12.76 Typ 237 ⁴⁾ 12.83 Typ 237 ⁴⁾ Typ 459 ⁶⁾ Typ 540 ⁷⁾ 12.76 Typ 224 ¹⁰⁾ + HA-Rz 50,80 ¹³⁾ Typ 526 ⁹⁾ 12.76 Typ 224 ¹⁰⁾ 12.83 Typ 224 ¹⁰⁾ Typ 526 ⁹⁾ Typ 524 ¹⁴⁾ Typ 525 ¹²⁾	83.6103-0650.3 83.6103-0800.3 83.6103-0650.3 83.6103-0800.3 83.6103-0650.3 83.6103-0500.3 83.6103-0650.3 83.6103-0800.3 83.6103-0700.3 83.6103-0650.3 83.6103-0800.3 83.6103-0650.3	330235 330237 330235 330237 330235 330230 330235 330237 330236 330235 330237 330235		L=650 L=800 L=650 L=800 L=650 L=500 L=650 L=800 L=700 L=650 L=800 L=650
--	--	--	--	---	--	--	--	--

MAN LKW 16.168-16.361

	16.168 F 16.168 F/FL-FKO 16.168 FM-FKO 16.168 H 16.192 F 16.192 F/FL-FKO 16.192 FM-FKO 16.192 H 16.215 FN 16.230 FL/FN 16.240 F 16.240 F 16.240 F/FL 16.240 H 16.240 H 16.240 HA 16.250 FN 16.256 DH/DHA/FAE 16.280 H/HA 16.281 F/FA 16.281 H 16.281 HA 16.304 F/FVS 16.320 F 16.321 F/FA		01.73 01.82 01.72 01.73 01.73 01.82 01.72 01.73 01.73 01.74 01.81 01.73 01.79 01.79 01.77 01.79 01.80 01.77 01.72 01.79	12.83 Typ 255/410 ¹⁵⁾ Typ 543 ¹⁶⁾ Typ 174 ¹⁷⁾ 12.85 Typ 253/540 ¹⁸⁾ Typ 255/410 ¹⁵⁾ Typ 543 ¹⁶⁾ Typ 174 ¹⁷⁾ Typ 253/540 ¹⁸⁾ Typ 314 ¹⁹⁾ Typ 258 ²⁰⁾ Typ 527 ²¹⁾ Typ 313 ²²⁾ Typ 524 ¹⁴⁾ Typ 525 ¹²⁾ Typ 420/421 ²³⁾ Typ 503/505 ²⁴⁾ Typ 501 ²⁵⁾ Typ 502 ²⁶⁾ Typ 222 ²⁷⁾ Typ 503/505 ²⁴⁾	03.0370-1131.2	051131		Hz Reparatursatz
--	---	--	--	--	----------------	--------	--	------------------

¹⁾ type 232/523 / tipo 232/523 / type 232/523 / tipo 232/523
²⁾ type 901/903 / tipo 910/903 / type 901/903 / tipo 901/903
³⁾ type 523 / tipo 523 / type 523 / tipo 523
⁴⁾ type 237 / tipo 237 / type 237 / tipo 237
⁵⁾ type 235/540 / tipo 235/540 / type 235/540 / tipo 235/540
⁶⁾ type 459 / tipo 459 / type 459 / tipo 459
⁷⁾ type 540 / tipo 540 / type 540 / tipo 540
⁸⁾ type 224/226 / tipo 224/226 / type 224/226 / tipo 224/226
⁹⁾ type 526 / tipo 526 / type 526 / tipo 526

¹⁰⁾ type 224 / tipo 224 / type 224 / tipo 224
¹¹⁾ type 226/524 / tipo 226/524 / type 226/524 / tipo 226/524
¹²⁾ type 525 / tipo 525 / type 525 / tipo 525
¹³⁾ + RA WC 50,80 / + P CR 50,80 / + ess. AR CR 50,80 / + ET CR 50,80
¹⁴⁾ type 524 / tipo 524 / type 524 / tipo 524
¹⁵⁾ type 255/410 / tipo 255/410 / type 255/410 / tipo 255/410
¹⁶⁾ type 543 / tipo 543 / type 543 / tipo 543
¹⁷⁾ type 174 / tipo 174 / type 174 / tipo 174
¹⁸⁾ type 253/540 / tipo 253/540 / type 253/540 / tipo 253/540



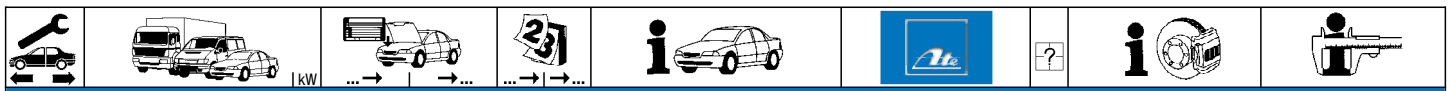

MAN LKW 16.168-16.361

	16.321 H/HA 16.361 F/FL		01.79 01.84	Typ 501/502 ¹⁾ Typ 503/504 ²⁾	03.0370-1131.2 051131		Hz Reparatursatz
	16.168 F 16.168 F/FL-FKO 16.168 FM-FKO 16.168 H 16.192 F 16.192 F/FL-FKO 16.192 FM-FKO 16.192 H 16.215 FN 16.230 FL/FN 16.240 F 16.240 F 16.240 F/FL 16.240 H 16.240 HA 16.240 HA 16.250 FN 16.256 DH/DHA/FAE 16.280 H/HA 16.281 F/FA 16.281 H 16.281 HA 16.304 F/FVS 16.320 F 16.321 F/FA 16.321 H/HA 16.361 F/FL		01.73 01.82 01.72 01.73 01.73 01.82 01.72 01.73 01.73 01.79 01.79 01.72 01.79 01.84	12.83 Typ 255/410 ³⁾ Typ 543 ⁴⁾ Typ 174 ⁵⁾ Typ 253/540 ⁶⁾ Typ 255/410 ³⁾ Typ 543 ⁴⁾ Typ 174 ⁵⁾ Typ 253/540 ⁶⁾ Typ 314 ⁷⁾ Typ 258 ⁸⁾ Typ 527 ⁹⁾ Typ 313 ¹⁰⁾ Typ 524 ¹¹⁾ Typ 525 ¹²⁾ Typ 420/421 ¹³⁾ Typ 503/505 ¹⁴⁾ Typ 501 ¹⁵⁾ Typ 502 ¹⁶⁾ Typ 222 ¹⁷⁾ Typ 503/505 ¹⁴⁾ Typ 501/502 ¹⁾ Typ 503/504 ²⁾	03.3508-0501.3 310017		Behälter
	16.168 F 16.168 F/FL-FKO 16.168 FM-FKO 16.168 H 16.192 F 16.192 F/FL-FKO 16.192 FM-FKO 16.192 H 16.215 FN 16.230 FL/FN		01.73 01.82 01.72 01.73 01.73 01.82 01.72 01.73	12.83 Typ 255/410 ³⁾ Typ 543 ⁴⁾ Typ 174 ⁵⁾ Typ 253/540 ⁶⁾ Typ 255/410 ³⁾ Typ 543 ⁴⁾ Typ 174 ⁵⁾ Typ 253/540 ⁶⁾	83.6103-0650.3 330235		L=650
	16.240 F		01.74	05.78 Typ 258/ - Luftfederung ¹⁸⁾	83.6103-0700.3 330236		L=700
	16.240 F 16.240 F 16.240 F/FL 16.240 H 16.240 H 16.240 HA 16.250 FN 16.256 DH/DHA/FAE 16.280 H/HA 16.281 F/FA 16.281 H 16.281 HA 16.304 F/FVS 16.321 F/FA 16.321 H/HA 16.361 F		01.74 06.78 01.81 01.73 01.79 01.79 01.77 01.79 01.80 01.77 01.79 01.79 01.84	05.78 Typ 258/ + Luftfederung ¹⁹⁾ Typ 258 ⁸⁾ Typ 527 ⁹⁾ Typ 313 ¹⁰⁾ Typ 524 ¹¹⁾ Typ 525 ¹²⁾ Typ 420/421 ¹³⁾ Typ 503/505 ¹⁴⁾ Typ 501 ¹⁵⁾ Typ 502 ¹⁶⁾ Typ 503/505 ¹⁴⁾ Typ 501/502 ¹⁾ Typ 503 ²⁰⁾	83.6103-0650.3 330235		L=650

MAN LKW 19.168-19.361

	19.192 H/HA 19.215 DF/DFK/DFS 19.215 DH/DHK/DHKA 19.215 DHS/DHSA 19.215 H/HA 19.230 DF/DFK/DFS 19.230 DH/DHK/DHKA 19.230 DHS/DHSA 19.230 H/HA 19.250 DF/DFK/DFS 19.256 DH/DHA 19.280 H/HA 19.281 F/FA 19.281 H/HA 19.304 DF/DFR 19.320 F 19.321 F/FA 19.321 H/HA 19.361 F		01.77 01.79 01.79 01.72 01.79 01.79 01.84	12.82 Typ 420/421 ¹³⁾ Typ 523/624/505 ²¹⁾ Typ 501/502 ¹⁾ Typ 222 ¹⁷⁾ Typ 523/624/505 ²¹⁾ Typ 501/502 ¹⁾ Typ 523 ²²⁾	03.0370-1131.2 051131		Hz Reparatursatz
	19.192 H/HA 19.215 DF/DFK/DFS 19.215 DH/DHK/DHKA 19.215 DHS/DHSA 19.215 H/HA 19.230 DF/DFK/DFS 19.230 DH/DHK/DHKA 19.230 DHS/DHSA 19.230 H/HA				03.3508-0501.3 310017		Behälter

¹⁾ type 501/502 / tipo 501/502 / type 501/502 / tipo 501/502
²⁾ type 503/504 / tipo 503/504 / type 503/504 / tipo 503/504
³⁾ type 255/410 / tipo 255/410 / type 255/410 / tipo 255/410
⁴⁾ type 543 / tipo 543 / type 543 / tipo 543
⁵⁾ type 174 / tipo 174 / type 174 / tipo 174
⁶⁾ type 253/540 / tipo 253/540 / type 253/540 / tipo 253/540
⁷⁾ type 314 / tipo 314 / type 314 / tipo 314
⁸⁾ type 258 / tipo 258 / type 258 / tipo 258
⁹⁾ type 527 / tipo 527 / type 527 / tipo 527

¹⁰⁾ type 313 / tipo 313 / type 313 / tipo 313
¹¹⁾ type 524 / tipo 524 / type 524 / tipo 524
¹²⁾ type 525 / tipo 525 / type 525 / tipo 525
¹³⁾ type 420/421 / tipo 420/421 / type 420/421 / tipo 420/421
¹⁴⁾ type 503/505 / tipo 503/505 / type 503/505 / tipo 503/505
¹⁵⁾ type 501 / tipo 501 / type 501 / tipo 501
¹⁶⁾ type 502 / tipo 502 / type 502 / tipo 502
¹⁷⁾ type 222 / tipo 222 / type 222 / tipo 222
¹⁸⁾ type 258/ - pneumatic suspens. / tipo 258/ - suspens.pneumatica / type 258/ - susp.pneumatique / tipo 258/ - suspens.neumática

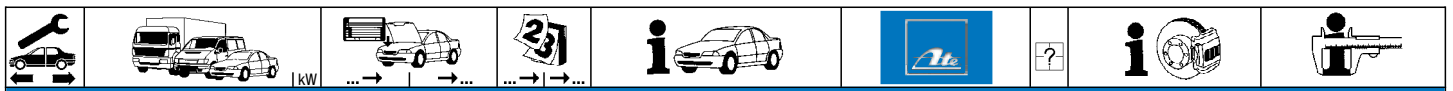

MAN LKW 19.168-19.361

	19.250 DF/DFK/DFS 19.256 DH/DHA 19.280 H/HA 19.281 F/FA 19.281 H/HA 19.304 DF/DFR 19.320 F 19.321 F/FA 19.321 H/HA 19.361 F			01.77 01.79 01.79	12.82 12.85 12.85	Typ 420/421 ¹⁾ Typ 523/624/505 ²⁾ Typ 501/502 ³⁾	03.3508-0501.3	310017		Behälter
	19.192 H/HA 19.215 DF/DFK/DFS 19.215 DH/DHK/DHKA 19.215 DHS/DHSA 19.215 H/HA 19.230 DF/DFK/DFS 19.230 DH/DHK/DHKA 19.230 DHS/DHSA 19.230 H/HA 19.250 DF/DFK/DFS 19.256 DH/DHA 19.280 H/HA 19.281 F/FA 19.281 H/HA 19.304 DF/DFR 19.321 F/FA 19.321 H/HA 19.361 F			01.77 01.79 01.79	12.82 12.85 12.85	Typ 420/421 ¹⁾ Typ 523/624/505 ²⁾ Typ 501/502 ³⁾	83.6103-0650.3	330235		L=650
	19.215 DH/DHK/DHKA 19.215 DHS/DHSA/HA 19.230 DH/DHK/DHKA 19.230 DHS/DHSA/HA 19.304 DF/DFR						83.6103-0260.3	330221	<input type="checkbox"/>	L=260
	19.215 DH/DHK/DHS 19.215 DHKA/DHSA 19.230 DH/DHK/DHS 19.230 DHKA/DHSA			12.69 12.69 12.69 12.69			03.0450-2509.2	082509		Nz Reparatursatz
	19.192 DH/DHA 19.215 DH 19.215 DHA 19.215 DHK/DHKA 19.215 DHS/DHSA			01.69 01.69			83.6203-0260.3	330300		L=260
	19.230 DH 19.230 DHA 19.230 DHK/DHKA 19.230 DHS/DHSA			01.69			83.6203-0260.3	330300		L=260

MAN LKW 20.192-20.321

	20.192 DH 20.280 DFAEG			01.75 01.78	12.80 12.80	Typ 213 ⁶⁾ Typ 433 ⁷⁾	03.0370-1131.2	051131		Hz Reparatursatz
	20.192 DH 20.280 DFAEG			01.75 01.78	12.80 12.80	Typ 213 ⁶⁾ Typ 433 ⁷⁾	03.3508-0501.3	310017		Behälter
	20.280 DFAEG			01.78		Typ 433 ⁷⁾	83.6103-0320.3	330224		L=320

MAN LKW 21.212

	21.212 DH/DHA						03.0370-1131.2	051131		Hz Reparatursatz
	21.212 DH/DHA						03.3508-0501.3	310017		Behälter
	21.212 DH/DHA						83.6103-0650.3	330235		L=650
	21.212 DH/DHA						03.0450-2509.2	082509		Nz Reparatursatz
	21.212 DH/DHA						83.6203-0260.3	330300		L=260

MAN LKW 22.192-22.321

	22.192 DF-KO 22.192 DH 22.192 FN 22.215 DH/DHA 22.215 DHK/DHKA 22.215 DHS/DHSA 22.230 DH/DHA 22.230 DHK/DHKA 22.230 DHS/DHSA			01.79 01.75	12.82 12.80	Typ 445 ⁸⁾ Typ 213 ⁶⁾	03.0370-1131.2	051131		Hz Reparatursatz
--	--	--	--	----------------	----------------	--	----------------	--------	--	------------------

¹⁾ type 420/421 / tipo 420/421 / type 420/421 / tipo 420/421
²⁾ type 523/624/505 / tipo 523/624/505 / type 523/624/505 / tipo 523/624/505
³⁾ type 501/502 / tipo 501/502 / type 501/502 / tipo 501/502
⁴⁾ type 222 / tipo 222 / type 222 / tipo 222
⁵⁾ type 523 / tipo 523 / type 523 / tipo 523
⁶⁾ type 213 / tipo 213 / type 213 / tipo 213
⁷⁾ type 433 / tipo 433 / type 433 / tipo 433
⁸⁾ type 445 / tipo 445 / type 445 / tipo 445



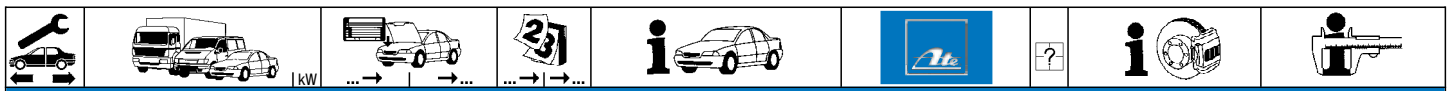

MAN LKW 22.192-22.321

	22.304 FN 22.320 F 22.320 FNL					03.0370-1131.2	051131		Hz Reparatursatz
	22.192 DF-KO 22.192 DH 22.192 FN 22.215 DH/DHA 22.215 DHK/DHKA 22.215 DHS/DHSA 22.230 DH/DHA 22.230 DHK/DHKA 22.230 DHS/DHSA 22.304 FN 22.320 F 22.320 FNL		01.72	12.80	Typ 212 ¹⁾				Behälter
	22.192 FN 22.215 DH/DHA 22.215 DHK/DHKA 22.215 DHS/DHSA 22.230 DH/DHA 22.230 DHK/DHKA 22.230 DHS/DHSA 22.304 FN 22.320 F					83.6103-0650.3	330235		L=650
	22.215 DH/DHA 22.215 DHK/DHKA 22.215 DHS/DHSA 22.230 DH/DHA 22.230 DHK/DHKA 22.230 DHS/DHSA					83.6103-0260.3	330221	<input type="checkbox"/>	L=260
	22.215 DH/DHK/DHS 22.215 DHKA/DHSA 22.230 DH/DHK/DHS 22.230 DHKA/DHSA			12.69 12.69 12.69 12.69		03.0450-2509.2	082509		Nz Reparatursatz
	22.215 DH 22.215 DHA 22.215 DHK/DHKA 22.215 DHS/DHSA		01.69			83.6203-0260.3	330300		L=260
	22.230 DH 22.230 DHA 22.230 DHK/DHKA 22.230 DHS/DHSA		01.69			83.6203-0260.3	330300		L=260

MAN LKW 26.162-26.365

	26.192 DH/DHA 26.215 DF/DH/DHA 26.230 DF/DH/DHA 26.240 DH/DHA 26.256 DF/DH 26.256 DHA 26.280 DH 26.281 DH/DHA 26.304 DF/DFA/DFL 26.320 DF 26.320 DHA 26.321 DH/DHA		01.79 01.72		Typ 532/533 ⁴⁾ Typ 274/278 ⁵⁾				Hz Reparatursatz
	26.192 DH/DHA 26.215 DF/DH/DHA 26.230 DF/DH/DHA 26.240 DH/DHA 26.256 DF/DH 26.256 DHA 26.280 DH 26.281 DH/DHA 26.304 DF/DFA/DFL 26.320 DF 26.320 DHA 26.321 DH/DHA		01.79 01.72	12.82	Typ 423 ⁶⁾ Typ 507/508 ⁷⁾				Behälter
	26.192 DH/DHA 26.215 DF/DH/DHA 26.230 DF/DH/DHA 26.240 DH/DHA 26.256 DHA 26.281 DH/DHA 26.304 DF/DFA/DFL 26.320 DF 26.320 DHA 26.321 DH/DHA		01.79 01.80		Typ 532/533 ⁴⁾ - Typ 279 ¹⁰⁾ Typ 507/508 ⁷⁾				L=650
	26.192 DH/DHA 26.215 DF/DH/DHA 26.230 DF/DH/DHA 26.240 DH/DHA 26.256 DHA 26.281 DH/DHA 26.304 DF/DFA/DFL 26.320 DF 26.320 DHA 26.321 DH/DHA		01.72 01.80	12.86	Typ 225 ⁸⁾ Typ 242 ⁹⁾ Typ 507/508 ⁷⁾				

MAN LKW 30.192-30.321

	30.192 DHA 30.215 DH/DHA 30.230 DH/DHA 30.256 DH/DHA 30.281 VF 30.304 DFA 30.320 DF		01.80 01.72	12.85	Typ 512 ¹¹⁾ Typ 225 ⁸⁾		03.0370-1131.2	051131	Hz Reparatursatz
--	---	--	----------------	-------	---	--	----------------	--------	------------------

¹⁾ type 212 / tipo 212 / type 212 / tipo 212
²⁾ type 445 / tipo 445 / type 445 / tipo 445
³⁾ type 213 / tipo 213 / type 213 / tipo 213
⁴⁾ type 532/533 / tipo 532/533 / type 532/533 / tipo 532/533
⁵⁾ type 274/278 / tipo 274/278 / type 274/278 / tipo 274/278
⁶⁾ type 423 / tipo 423 / type 423 / tipo 423
⁷⁾ type 507/508 / tipo 507/508 / type 507/508 / tipo 507/508
⁸⁾ type 225 / tipo 225 / type 225 / tipo 225
⁹⁾ type 242 / tipo 242 / type 242 / tipo 242
¹⁰⁾ - type 279 / - tipo 279 / - type 279 / - tipo 279
¹¹⁾ type 512 / tipo 512 / type 512 / tipo 512



MAN LKW 30.192-30.321										
	30.321 VF			01.80	12.85	Typ 512 ¹⁾	03.0370-1131.2	051131		Hz Reparatursatz
	30.192 DHA 30.215 DH/DHA 30.230 DH/DHA 30.256 DH/DHA 30.281 VF 30.304 DFA 30.320 DF 30.321 VF			01.80	12.85	Typ 512 ¹⁾	03.3508-0501.3	310017		Behälter
	30.192 DHA 30.215 DH/DHA 30.230 DH/DHA 30.256 DH/DHA 30.281 VF 30.304 DFA 30.320 DF 30.321 VF			01.80	12.85	Typ 512 ¹⁾	83.6103-0650.3	330235		L=650

MAN LKW 32.280-32.365										
	32.280 DH 32.281 DH/DHA 32.320 DF 32.321 DH/DHA			01.77	12.82	Typ 423 ³⁾ Typ 507/508 ⁴⁾	03.0370-1131.2	051131		Hz Reparatursatz
	32.280 DH 32.281 DH/DHA 32.320 DF 32.321 DH/DHA			01.80	12.86	Typ 225 ²⁾ Typ 507/508 ⁴⁾	03.3508-0501.3	310017		Behälter
	32.281 DH/DHA 32.320 DF 32.321 DH/DHA			01.80	12.86	Typ 225 ²⁾ Typ 507/508 ⁴⁾	83.6103-0650.3	330235		L=650

MAN LKW 33.240-33.365										
	33.320 DF			01.82	12.86	Typ 225 ²⁾	03.0370-1131.2	051131		Hz Reparatursatz
	33.320 DF			01.82	12.86	Typ 225 ²⁾	03.3508-0501.3	310017		Behälter
	33.320 DF			01.82	12.86	Typ 225 ²⁾	83.6103-0650.3	330235		L=650

MAN LKW 415-2180										
	415 F/FS 415 H/HA/HK/HS/HSA 450 H/HA 520 F/H/HA/H-SKD 620 F/H/HA 626 635 F/H/HA 635 FMW 635 L1/L1F 635 L1A/L1FA 650 F/H/HA 770 L1/L1A/L1F			01.65	12.67 12.65 12.65		03.3131-0601.3	010299		Hz 31,75 ATE
	1070 L1 1080 F/H/HA 1570 H/HA/HK/HKA 1580 DF/DH 780 F/H/HA 850 H/HA			01.63			03.0370-1131.2	051131		Hz Reparatursatz
	1580 DAH						03.3131-0601.3	010299		Hz 31,75 ATE
	1580 FN 1580 FNMW			01.63			03.3131-0601.3 03.0370-1131.2	010299 051131	+ Vorderachse ⁵⁾ + Hinterachse ⁶⁾	Hz 31,75 ATE Hz Reparatursatz
	2170 H/HA/HK/HKA 2170 HS/HSA 2180 DHA						03.0370-1131.2	051131		Hz Reparatursatz
	1070 L1 1080 F/H/HA 1570 H/HA/HK/HKA 1580 DAH/DF/DH 415 F/FS 415 H/HA/HK/HS/HSA 450 H/HA 520 F/H/HA/H-SKD 620 F/H/HA 626 635 F/H/HA 635 FMW 635 L1/L1F 635 L1A/L1FA 650 F/H/HA 770 L1/L1A/L1F			01.65 01.63	12.67 12.65 12.65		03.3508-0501.3	310017		Behälter

¹⁾ type 512 / tipo 512 / type 512 / tipo 512
²⁾ type 225 / tipo 225 / type 225 / tipo 225
³⁾ type 423 / tipo 423 / type 423 / tipo 423
⁴⁾ type 507/508 / tipo 507/508 / type 507/508 / tipo 507/508
⁵⁾ + front axle / + asse anteriore / + essieu avant / + eje delantero
⁶⁾ + rear axle / + asse posteriore / + essieu arrière / + eje trasero



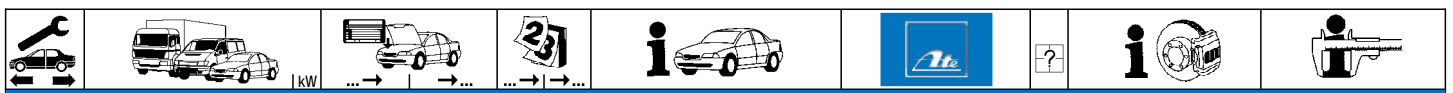

MAN LKW 415-2180

	780 F/H/HA 850 H/HA		01.63		03.3508-0501.3	310017			Behälter
	1580 FN 1580 FNMW		01.63		03.3508-0501.3 03.3508-0264.3	310017 310009		+ Vorderachse ¹⁾ + Hinterachse ²⁾	Behälter Behälter
	2170 H/HA/HK/HKA 2170 HS/HSA 2180 DHA				03.3508-0501.3	310017			Behälter
	415 F/FS 415 H/HA/HK/HS/HSA				83.6103-0550.3 83.6103-0260.3	330231 330221			L=550 L=260
	450 H/HA				83.6103-0650.3	330235			L=650
	520 F/H/HA				83.6103-0550.3 83.6103-0260.3	330231 330221			L=550 L=260
	520 H-SKD				83.6103-0550.3	330231			L=550
	620 F/H/HA 626				83.6103-0550.3 83.6103-0260.3	330231 330221			L=550 L=260
	635 F/HA				83.6103-0550.3	330231			L=550
	635 H				83.6103-0650.3	330235			L=650
	635 L1/L1F		12.65		83.6103-0550.3 83.6103-0260.3	330231 330221			L=550 L=260
	635 L1A/L1FA		12.65		83.6103-0650.3 83.6103-0260.3	330235 330221			L=650 L=260
	650 F		12.63		83.6103-0550.3	330231			L=550
	650 H		12.63		83.6103-0620.3	330234			L=620
	650 HA		12.63		83.6103-0650.3	330235			L=650
	770 L1/L1A/L1F				83.6103-0620.3	330234			L=620
	780 F/H/HA 850 H/HA		01.63		83.6103-0650.3	330235			L=650
	1070 L1 1080 H/HA				83.6103-0620.3 83.6103-0260.3	330234 330221			L=620 L=260
	1080 F				83.6103-0650.3	330235			L=650
	1570 H/HA/HK/HKA				83.6103-0650.3 83.6103-0260.3	330235 330221			L=650 L=260
	1580 DF				83.6103-0650.3	330235			L=650
	1580 DH/DHA				83.6103-0700.3	330236			L=700
	1580 FN		01.63		83.6103-0620.3	330234			L=620
	1580 FNMW				83.6103-0550.3	330231			L=550
	2170 H/HA/HK/HKA 2170 HS/HSA				83.6103-0650.3 83.6103-0260.3	330235 330221			L=650 L=260
	2180 DHA				83.6103-0650.3	330235			L=650
	1070 L1 1080 F/H/HA 1580 DF/DH/DHA/DN 1580 FN/FNWM 2180 DHA/H 635 F/L1/L1A/L1F 780 F/HA 850 H/HA				03.0450-2509.2	082509			Nz Reparatursatz
	635 F/L1/L1A/L1F				83.6103-0550.3	330231			L=550
	1070 L1 1080 F/H/HA 1580 DF/DH/DHA/DN 1580 FN/FNWM 2180 DHA/H 780 F/HA 850 H/HA				83.6203-0260.3	330300			L=260

MAN LKW 6.115

	6.115 H/HK/HKA/HS				03.3131-0601.3	010299			Hz 31,75	ATE
	6.115 H/HK/HKA/HS				03.3508-0501.3	310017			Behälter	
	6.115 H/HK/HKA/HS				83.6103-0550.3	330231			L=550	
	6.115 H/HK/HKA/HS				83.6103-0260.3	330221			L=260	

MAN LKW 7.126-7.136

	7.126 H/HK/HKA/HS				03.3131-0601.3	010299		L=177/ Hub=50 ³⁾	Hz 31,75	ATE
	7.126 H/HA				03.0370-1131.2	051131			Hz Reparatursatz	
	7.135 H/HK/HS 7.135 HA/HAK				03.3131-0601.3	010299			Hz 31,75	ATE
	7.136 H/HA				03.0370-1131.2	051131			Hz Reparatursatz	

¹⁾ + front axle / + asse anteriore / + essieu avant / + eje delantero

²⁾ + rear axle / + asse posteriore / + essieu arrière / + eje trasero

³⁾ L=177/ stroke=50 / L=177/ corsa=50 / L=177/ course=50 / L=177/ carrera=50

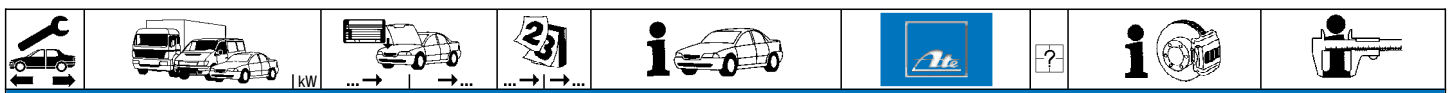

MAN LKW 7.126-7.136										
	7.126 H/HK/HS 7.126 HA/HKA 7.135 H/HK/HS 7.135 HA/HAK 7.136 H/HA					03.3508-0501.3	310017			Behälter
	7.126 H/HA/HK/HKA 7.126 HS					83.6103-0550.3	330231			L=550
	7.135 H/HK/HS					83.6103-0650.3	330235			L=650
	7.135 HA/HAK 7.136 H/HA					83.6103-0550.3	330231			L=550
	7.126 H/HA/HK/HKA 7.126 HS 7.136 H/HA					83.6103-0260.3	330221		■	L=260
	7.135 H/HA					03.0450-2509.2	082509			Nz Reparatursatz
	7.126 H/HK/HS 7.126 HA/HKA/HSA 7.136 H/HA/HK 7.136 HKA/HS/HSA					83.6203-0260.3	330300			L=260

























MAN LKW 8.156-8.168										
	8.156 F/FK/FS 8.156 H/HK/HS 8.156 HA/HKA/HSA					03.3131-0601.3	010299			Hz 31,75 ATE
	8.156 F/FK/FS 8.156 H/HK/HS 8.156 HA/HKA/HSA					03.3508-0501.3	310017			Behälter
	8.156 F/FK/FS					83.6103-0550.3	330231			L=550
	8.156 H/HK/HS 8.156 HA/HKA/HSA					83.6103-0650.3	330235			L=650
	8.156 H/HK/HS 8.156 HA/HKA/HSA			12.69 12.69		03.0450-2509.2	082509			Nz Reparatursatz
	8.126 H/HA					83.6203-0260.3	330300			L=260
	8.156 H/HK/HS 8.156 HA/HKA/HSA 8.160 H/HA 8.168 H/HA				01.69	83.6203-0260.3	330300			L=260

MAN LKW 9.126-9.216										
	9.136 H/HA 9.156 F/FK/FS 9.160 F/FK/FS/H 9.168 H 9.186 F/FK/FS 9.186 H/HA/HK/HKA 9.186 HS/HSA 9.192 H/HA 9.216 H/HAF					03.0370-1131.2	051131			Hz Reparatursatz
	9.136 H/HA 9.156 F/FK/FS 9.160 F/FK/FS/H 9.168 H 9.186 F/FK/FS 9.186 H/HA/HK/HKA 9.186 HS/HSA 9.192 H/HA 9.216 H/HAF					03.3508-0501.3	310017			Behälter
	9.136 H/HA 9.156 F/FK/FS 9.160 F/FK/FS/H 9.168 H 9.186 F/FK/FS 9.186 H/HA/HK/HKA 9.186 HS/HSA 9.192 H/HA 9.216 H/HAF					83.6103-0650.3	330235			L=650
	9.156 H/HA/HS 9.156 HK/HKA/HSA 9.156 HR 9.160 H/HA/HS 9.160 HK/HKA/HSA			12.69 12.69		03.0450-2509.2	082509			Nz Reparatursatz
	9.186 H/HA/HS 9.186 HA/HKA/HSA 9.186 HR			12.69 12.69		03.0450-2509.2	082509			Nz Reparatursatz
	9.215 HR					03.0450-2509.2	082509			Nz Reparatursatz
	9.126 H/HA 9.156 HR			01.69		83.6203-0260.3	330300			L=260
	9.156 H/HA/HS 9.156 HK/HKA/HSA 9.160 H/HA/HS			12.69 12.69 12.69		83.6103-0260.3 83.6203-0260.3	330221 330300		Innen- u. Außengewinde ¹⁾ 2x Innengewinde ²⁾	L=260 L=260
	9.156 H/HA/HS 9.156 HK/HKA/HSA 9.160 H/HA/HS			12.69 12.69 12.69		83.6203-0260.3	330300			L=260

¹⁾ inner and outer thread / filettatura interna + esterno / taraud. intérieur + extérieur / rosca interior + exterior

²⁾ 2x inner thread / 2x filettatura interna / 2x taraudage intérieur / 2x rosca interior



















								
MAN LKW 9.126-9.216								
	9.160 HK/HKA/HSA			12.69	83.6203-0260.3	330300		L=260
	9.186 HR				83.6103-0260.3	330221	Innen- u. Außengewinde ¹⁾	L=260
					83.6203-0260.3	330300	2x Innengewinde ²⁾	L=260
	9.186 H/HA/HK/HKA				83.6203-0260.3	330300		L=260
	9.186 HS/HSA							
	9.192 H/HA/HK/HKA							
	9.192 HS/HSA							
	9.215 HR				83.6103-0260.3	330221	Innen- u. Außengewinde ¹⁾	L=260
					83.6203-0260.3	330300	2x Innengewinde ²⁾	L=260
MASERATI MASERATI								
	Biturbo 2000			01.82	13.0441-4018.2	250083		Dichtungssatz ATE
	Biturbo 222			01.88 12.88	13.0441-4018.2	250083		Dichtungssatz ATE
	Biturbo 420			01.85 12.87				
	Biturbo 425			01.85 12.87				
	228			01.89	11.0441-5702.2	250033		Dichtungssatz ATE
	Biturbo 222			01.89	11.8116-0091.1	390502	2	Haltefeder ATE
	Biturbo 430			01.89	11.0101-5407.2	260011		Hülensatz ATE
	Biturbo Karif			01.89	11.8171-0008.1	990049		Führungsbolzen ATE
	Biturbo Spider			01.89				
	Biturbo 2000			01.82	13.0441-3303.2	250043		Dichtungssatz ATE
	228			01.89	13.0441-3303.2	250043		Dichtungssatz ATE
	Biturbo 222			01.88				
	Biturbo 420			01.85 12.87				
	Biturbo 425			01.85 12.87				
	Biturbo 430			01.89				
	Biturbo Karif			01.89				
	Biturbo Spider			01.89				
MAZDA 121 (87-91)								
	1.1 (DA1)	42		11.87 03.91	13.0460-5970.2	605970		21355 13,5 +WK SUM
	1.3 (DA1)			11.87 03.91	13.0460-0451.2	610451		Belagsatz-Zubehör SUM
	1.1 (DA1)	42		11.87 03.91	24.0113-0165.1	413165		219 13,0 11,0
	1.3 (DA1)			11.87 03.91				
	1.1 (DA1)	42		11.87 03.91	03.0137-0204.2	650204		170 x 25
	1.3 (DA1)			11.87 03.91	03.0137-9113.2	669113		Bremsbacken-Zubehör
MAZDA 121 (91-96)								
	1.3 16V (DB1)			04.91 02.96	13.0460-5944.2	605944		21654 15,0 +WK SUM
					13.0460-0339.2	610339		Belagsatz-Zubehör SUM
	1.3 16V (DB1)			04.91 02.96	24.0112-0147.1	412147		235 12,0 10,0
	1.3 16V (DB1)			04.91 02.96	24.0118-0113.1	418113		235 18,0 16,0 V +B
	1.3 16V (DB1)			04.91 02.96	03.0137-0263.2	650263		180 x 31
					03.0137-9186.2	669186		Bremsbacken-Zubehör
MAZDA 323 Limousine (85-89)								
	1.1 (BF)			07.85 08.87	24.0101-5102.2	260056		Bremssattel-Zubehör SUM
	1.3 (BF)			07.85 08.89				
	1.5 (BF)			07.85 08.89				
	1.6 i (BF)			07.85 08.89				
	1.6 i Turbo (BF)			07.85 08.89				
	1.6 i Turbo 4WD (BF)			07.85 08.89				
	1.7 D (BF)			07.85 08.89				
	1.1 (BF)			07.85 08.87	24.0118-0101.1	418101		238 18,0 16,0 V
	1.3 (BF)			07.85 08.89				
	1.5 (BF)			07.85 08.89				
	1.6 i (BF)			07.85 08.89				
	1.7 D (BF)			07.85 08.89				
	1.6 i (BF)			07.85 08.89	13.0460-5824.2	605824		20008 13,0 AKE
	1.6 i Turbo (BF)			07.85 08.89				
	1.6 i Turbo 4WD (BF)			07.85 08.89				
	1.1 (BF)			07.85 08.87	24.3217-1703.3	020380		Rz 17,46
	1.3 (BF)			07.85 08.89				
	1.5 (BF)			07.85 08.89				
	1.6 i (BF)			07.85 08.89				
	1.7 D (BF)			07.85 08.89				
	1.1 (BF)			07.85 08.87	03.0137-0183.2	650183		200 x 26
	1.3 (BF)			07.85 08.89				
	1.5 (BF)			07.85 08.89				
	1.6 i (BF)			07.85 08.89				
	1.7 D (BF)			07.85 08.89				
	1.1 (BF)			07.85 08.87	24.0220-0029.1	480120		200/201 x 32
	1.3 (BF)			07.85 08.89				
	1.5 (BF)			07.85 08.89				
	1.6 i (BF)			07.85 08.89				
	1.7 D (BF)			07.85 08.89				

¹⁾ inner and outer thread / filettatura interna + esterno / taraud. intérieur + extérieur / rosca interior + exterior





























²⁾ 2x inner thread / 2x filettatura interna / 2x taraudage intérieur / 2x rosca interior

³⁾ + manual transmission / + scatola cambio velocità / + transmission mécanique / + cambio de velocidad















⁴⁾ + autom.transmission / + scatola cambio automatico / + transmission automatique / + cambio automático

MAZDA 323 Limousine/323 F (89-94)						
	1.3 i (BG) 1.6 i (BG) 1.7 D (BG) 1.8 i 16V (BG) 1.8 i 16V 4WD (BG) 1.8 i 16V (BG) 1.8 i Turbo 4WD (BG) 120	09.89 12.94 09.89 12.94 09.89 12.94 09.89 12.94 + OHC 09.89 12.94 09.89 12.94 + DOHC 09.89 12.94	13.0460-5944.2 605944 13.0460-0339.2 610339		21654 15,0 +/-WK Belagsatz-Zubehör	SUM
	1.3 i (BG) 1.6 i (BG) 1.7 D (BG) 1.8 i 16V (BG) 1.3 i (BG) 1.6 i (BG) 1.6 i (BG) 1.8 i 16V (BG) 1.8 i 16V (BG) 1.8 i Turbo 4WD (BG) 120	09.89 12.94 + Schaltgetriebe ¹⁾ 09.89 12.94 + HA-Trommelbr./+Schaltgetriebe ²⁾ 09.89 12.94 + Schaltgetriebe ¹⁾ 09.89 12.94 + OHC/+HA-Trommelbr./+Schaltg. ³⁾ 09.89 12.94 + Automatikgetriebe ⁴⁾ 09.89 12.94 + Automatikgetriebe ⁴⁾ 09.89 12.94 + HA-Scheibenbr./ +Schaltgetr. ⁵⁾ 09.89 12.94 + Automatikgetriebe ⁴⁾ 09.89 12.94 + OHC/+HA-Scheibenbr./+Schaltg. ⁶⁾ 09.89 12.94 + DOHC 09.89 12.94	24.0118-0113.1 418113 24.0122-0166.1 422166 24.0122-0165.1 422165		235 18,0 16,0 V +B 235 22,0 20,0 V +B 257 22,0 20,0 V	
	1.6 i (BG) 1.8 i 16V (BG) 1.8 i 16V 4WD (BG) 1.8 i Turbo 4WD (BG) 120	09.89 12.94 09.89 12.94 09.89 12.94 09.89 12.94	13.0460-5972.2 605972		21559 11,5	
	1.6 i (BG) 1.8 i 16V (BG) 1.8 i 16V 4WD (BG) 1.8 i Turbo 4WD (BG) 120	09.89 12.94 09.89 12.94 + OHC 09.89 12.94 09.89 12.94 + DOHC 09.89 12.94	24.0109-0127.1 409127 24.0109-0131.1 409131		231 9,0 8,0 251 9,0 8,0 +B	
	1.3 i (BG) 1.6 i (BG) 1.7 D (BG) 1.8 i 16V (BG)	09.89 12.94 09.89 12.94 09.89 12.94 09.89 12.94	24.3217-1120.3 020360		Rz 17,46	
	1.3 i (BG) 1.6 i (BG) 1.7 D (BG) 1.8 i 16V (BG)	09.89 04.91 09.89 04.91 09.89 04.91 09.89 04.91	03.0137-0239.2 650239 03.0137-9131.2 669131		200 x 26 Bremsbacken-Zubehör	
	1.3 i (BG) 1.6 i (BG) 1.7 D (BG) 1.8 i 16V (BG)	05.91 12.94 05.91 12.94 05.91 12.94 05.91 12.94	03.0137-0278.2 650278 03.0137-9182.2 669182		200 x 36 Bremsbacken-Zubehör	
	1.3 i (BG) 1.6 i (BG) 1.7 D (BG) 1.8 i 16V (BG)	05.91 12.94 05.91 12.94 05.91 12.94 05.91 12.94	24.0220-0026.1 480104		200/201 x 40	
	1.3 i (BG) 1.3 i (BG) 1.6 i (BG) 1.6 i (BG) 1.7 D (BG) 1.7 D (BG) 1.8 i 16V (BG) 1.8 i 16V (BG)	09.89 12.94 + HA-Trommelbremse/ + 4 türig ⁷⁾ 09.89 12.94 + HA-Trommelbremse/ + 5 türig ⁸⁾ 09.89 12.94 + HA-Trommelbremse/ + 4 türig ⁷⁾ 09.89 12.94 + HA-Trommelbremse/ + 5 türig ⁸⁾ 09.89 12.94 + HA-Trommelbremse/ + 4 türig ⁷⁾ 09.89 12.94 + HA-Trommelbremse/ + 5 türig ⁸⁾ 09.89 12.94 + HA-Trommelbremse/ + 4 türig ⁷⁾ 09.89 12.94 + HA-Trommelbremse/ + 5 türig ⁸⁾	24.3727-1811.2 581811 24.3727-1810.2 581810	<input type="checkbox"/> <input type="checkbox"/>	L=1503 L=1466	
MAZDA 323 Kombi (86-94)						
	1.5 (BW) 1.6 i (BW) 1.6 i 4x4 (BW) 1.7 D (BW)	05.86 12.94 05.86 12.94 09.89 12.94 05.86 12.94	24.0101-5102.2 260056		Bremsattel-Zubehör	SUM
	1.5 (BW) 1.6 i (BW) 1.6 i 4x4 (BW) 1.7 D (BW)	05.86 12.94 05.86 12.94 09.89 12.94 05.86 12.94	24.0118-0101.1 418101		238 18,0 16,0 V	
	1.6 i 4x4 (BW)	09.89 12.94	13.0460-5824.2 605824		2008 13,0	AKE
	1.5 (BW) 1.6 i (BW) 1.7 D (BW)	05.86 12.94 05.86 12.94 05.86 12.94	24.3217-1703.3 020380		Rz 17,46	
	1.5 (BW) 1.6 i (BW) 1.7 D (BW)	05.86 12.94 05.86 12.94 05.86 12.94	03.0137-0184.2 650184 03.0137-9102.2 669102		229 x 26 Bremsbacken-Zubehör	
MAZDA 626 (82-87)						
	1.6 (GC1) 1.8 (GC1) 2.0 (GC1) 2.0 D (GC1)	11.82 08.87 11.82 06.85 11.82 08.87 11.82 08.87	13.0460-5934.2 605934		21041 15,0 +	AKE
MAZDA 626 Limousine/Coupe (87-91)						
	1.6 (GD1) 1.8 (GD1) 2.0 (GD1) 2.0 (GD7) 2.0 D (GD1) 2.2 12V (GD1) 2.2 12V (GD7)	09.87 08.91 09.87 08.91 09.87 08.91 09.87 08.91 09.87 08.91 09.87 08.91 09.87 08.91	13.0460-5932.2 605932 13.0460-0313.2 610313		21378 15,0 +/-WK Belagsatz-Zubehör	AKE AKE

1) + manual transmission / + scatola cambio velocità / + transmission mécanique / + cambio de velocidad
2) + RA drum brake/+ manual transm. / + P fra tamburo/+ scatola camb.velocità / + fr.à tambour ess.AR/ + transm.mécan. / + ET-tamb.de freno/ + camb.de velocidad
3) + OHC/+RA drum br./+manual transm. / + OHC/+P fra tamb./+scatola camb.veloc. / + OHC/+fr.tamb.ess.AR/+transm.mécan. / + OHC/ + ET-tamb.fr./ + camb.velocidad
4) + autom.transmission / + scatola cambio automatico / + transmission automatique / + cambio automático
5) + RA disc brake/+ manual transm. / + P disco freno/+ scatola camb.velocità / + fr.à disque ess.AR/ + transm.mécanique / + ET disco de freno/ + camb.velocidad
6) + OHC/+RA disc br./+manual transm. / + OHC/+P disco fr. /+ scat.camb.velocità / + OHC/+fr.disqu.ess.AR/ + transm.mécan. / + OHC/ + ET-disco fr./ + camb.velocidad
7) + RA drum brake/ + 4 door / + P freno a tamburo/ + 4 porte / + fr.à tambour essieu AR/ + 4 portes / + ET tambores de freno/ + 4 puertas
8) + RA drum brake/ + 5 door / + P freno a tamburo/ + 5 porte / + fr.à tambour essieu AR/ + 5 portes / + ET tambores de freno/ + 5 puertas

									
MAZDA 626 Limousine/Coupe (87-91)									
	2.2 12V 4WD (GD1)		09.87	08.91	13.0460-5932.2	605932		21378 15,0 +/-WK Belagsatz-Zubehör	AKE AKE
	2.0 (GD1) 2.0 (GD7) 2.2 12V (GD1) 2.2 12V (GD7) 2.2 12V 4WD (GD1)		09.87 09.87 09.87 09.87 09.87	08.91 08.91 08.91 08.91 08.91	24.0124-0105.1	424105		264 24,0 22,0 V	
	2.0 (GD7) 2.2 12V (GD7)		09.87 09.87	08.91 08.91	13.0460-5995.2	605995		21558 13,0	
	2.0 (GD7)		09.87	08.91	24.0110-0181.1	410181		259 10,0 8,0	
	1.6 (GD1) 1.8 (GD1) 2.0 (GD1) 2.0 D (GD1) 2.2 12V (GD1)		09.87 09.87 09.87 09.87 09.87	08.91 08.91 08.91 08.91 08.91	24.3217-1120.3	020360		Rz 17,46	
	1.6 (GD1) 1.8 (GD1) 2.0 (GD1) 2.0 D (GD1) 2.2 12V (GD1)		09.87 09.87 09.87 09.87 09.87	08.91 08.91 08.91 08.91 08.91	03.0137-0185.2	650185		229 x 32 Bremsbacken-Zubehör	
	2.0 (GD1) 2.2 12V (GD1)		09.87 09.87	08.91 08.91	24.0222-8028.1	480143	ohne Sensorring ¹⁾	229/230 x 37	
	1.6 (GD1) 1.8 (GD1) 2.0 (GD1) 2.0 (GD7) 2.0 D (GD1) 2.2 12V (GD1) 2.2 12V (GD7)		09.87 09.87 09.87 09.87 09.87 09.87 09.87	08.91 08.91 08.91 08.91 08.91 08.91 08.91	24.3727-1812.2	581812		L=252	
MAZDA 626 Kombi (88-92)									
	1.8 (GV1) 2.0 (GV1) 2.0 D (GV1) 2.2 12V (GV1) 2.2 12V 4WD (GV8)	72 44 85 85	03.88 03.88 03.88 03.88 03.92	02.92 02.92 07.91 10.90 11.92	13.0460-5932.2	605932		21378 15,0 +/-WK Belagsatz-Zubehör	AKE AKE
	1.8 (GV1) 2.0 (GV1) 2.0 D (GV1) 2.2 12V (GV1) 2.2 12V 4WD (GV8)	72 44 85 85	03.88 03.88 03.88 03.88 03.92	02.92 02.92 07.91 10.90 11.92	24.0124-0105.1	424105		264 24,0 22,0 V	
	1.8 (GV1) 2.0 (GV1) 2.0 D (GV1) 2.2 12V (GV1)	72 44 85	03.88 03.88 03.88 03.88	02.92 02.92 07.91 10.90	13.0460-5995.2	605995		21558 13,0	
	1.8 (GV1) 2.0 (GV1) 2.0 D (GV1) 2.2 12V (GV1)	72 44 85	03.88 03.88 03.88 03.88	02.92 02.92 07.91 10.90	24.0110-0256.1	410256		259 10,0 8,0	
	1.8 (GV1) 2.0 (GV1) 2.0 D (GV1) 2.2 12V (GV1)	72 44 85	03.88 03.88 03.88 03.88	02.92 02.92 07.91 10.90	24.3727-1812.2	581812		L=252	
MAZDA 929 (87-91)									
	2.0 i (HC1) 2.2 i (HC1) 3.0 i V6 (HC1)		05.87 05.87 05.87	12.88 06.91 11.91	13.0460-5625.2	605625		21319 14,9 +/-WK	
MAZDA E1400/E1800/E2000/E2200 Bus (84-87)									
	1.4 1.8 2.0 2.0 4WD 2.2 D		01.84 01.84 01.84 01.84 01.84	11.87 11.87 11.87 11.87 11.87	13.0460-5806.2	605806		20002 15,0 +/-WK	
MAZDA E1800/E2000/E2200 Kasten (84-87)									
	1.8 2.0 2.2 D		01.84 01.84 01.84	11.87 11.87 11.87	13.0460-5806.2	605806		20002 15,0 +/-WK	
MAZDA E1800/E2000/E2200 Pritsche (84-87)									
	2.0 2.2 D		01.84 01.84	11.87 11.87	13.0460-5806.2	605806		20002 15,0 +/-WK	

¹⁾ without sensor ring / senza sensori / sans secours ABS / sin anillo sensor ABS

MERCEDES BENZ BUS (BM 302) O 302										
	10/11-Reiher 12-Reiher			01.65 01.65	12.75 12.75		83.6103-0450.3	330228		L=450
MERCEDES BENZ BUS (BM 307) O 307										
	0 307			04.73			03.2538-0104.3 03.0450-3801.2	040035 083801		Nz 38,10 Nz Reparatursatz
MERCEDES BENZ BUS (BM 309/310) O 309										
	2.2 - 60 PS 2.2 - 85 PS 3.8 - 85 PS	005165 000545 003884	018153 018153 018153				03.2122-2202.3 03.0370-3922.2	010140 053922		THz 22,20 THz Reparatursatz
	2.2 - 60 PS 2.2 - 85 PS 2.3 - 90 PS 2.4 - 65 PS 3.8 - 85 PS 3.8 - 85 PS	018154 018154 018154 018154 018154	530029	01.75 01.75	12.74		03.2122-4902.3 03.0370-3922.2	010144 053922		THz 22,20 THz Reparatursatz
	3.8 - 85 PS 5.7 - 130 PS	530030	352290	01.77			03.2125-1302.3	010203		THz 25,40
	2.2 - 60 PS 2.2 - 85 PS 3.8 - 85 PS		018153 018153 018153	01.67 01.67 01.69			03.3508-0264.3	310009		Behälter
	2.2 - 60 PS 2.2 - 85 PS 2.3 - 90 PS 2.4 - 65 PS 3.8 - 85 PS 5.7 - 130 PS			01.67 01.67 01.75 01.75 01.69 01.77	12.74		83.6133-0500.3	330272		L=500
	2.2 - 60 PS 2.2 - 85 PS 2.3 - 90 PS 2.4 - 65 PS 3.8 - 85 PS	000901 000181		01.75 01.75 01.69	12.74		03.3222-5804.3	020083		Rz 22,20
	3.8 - 85 PS			01.73			03.3222-5804.3 24.3223-1705.3	020083 020418	- VA 730.505/506 ³⁾ + VA 730.505/506 ⁴⁾	Rz 22,20 Rz 23,81
	3.8 - 85 PS 5.7 - 130 PS			01.78 01.77			24.3238-0901.3 24.3223-1705.3	020298 020418	+ breite Ausführung ⁵⁾	Rz 38,10 Rz 23,81
	2.2 - 60 PS 2.2 - 85 PS 2.3 - 90 PS 2.4 - 65 PS 3.8 - 85 PS 5.7 - 130 PS			01.67 01.67 01.75 01.75 01.69 01.77	12.74		83.6103-0450.3	330228		L=450
	2.2 - 60 PS 2.2 - 85 PS 2.3 - 90 PS 2.4 - 65 PS 3.8 - 85 PS	000901 000181		01.75 01.75 01.69	12.74		03.3222-5804.3	020083		Rz 22,20
	3.8 - 85 PS			01.73			03.3222-5804.3 24.3223-1705.3	020083 020418	- HA 741.203/302 ⁶⁾ + HA 741.203/302 ⁷⁾	Rz 22,20 Rz 23,81
	3.8 - 85 PS 5.7 - 130 PS			01.78 01.77			24.3238-0901.3 24.3223-1705.3	020298 020418	+ breite Ausführung ⁵⁾	Rz 38,10 Rz 23,81
MERCEDES BENZ BUS (BM 319) O 319										
	0 319			01.55	12.67		83.6103-0450.3	330228		L=450
	0 319			01.55	12.67		83.6103-0450.3	330228		L=450
MERCEDES BENZ BUS (BM 321) O 321										
	0 321			01.54	12.58		03.0370-1131.2	051131		Hz Reparatursatz
	0 321			01.59	12.64	+ 1-Kreis-Bremse ⁸⁾	03.0370-1131.2	051131		Hz Reparatursatz
	0 321			01.62	12.64	+ 2-Kreis-Bremse ⁹⁾	03.3318-0800.2	390112	2	im Anschlußkopf ¹⁰⁾
	0 321			01.59	12.64	+ 1-Kreis-Bremse ⁸⁾	03.3508-0501.3	310017		0,35 l Behälter
	0 321			01.54	12.64		83.6123-0381.3	330262		L=380
	0 321			01.54	12.64		83.6103-0400.3 83.6103-0500.3	330226 330230	<input type="checkbox"/>	L=400 L=500
MERCEDES BENZ BUS (BM 322) O 322										
	0 322			01.59	12.64		03.0370-1131.2	051131		Hz Reparatursatz

¹⁾ - wheel base 4100mm / - passo 4100mm / - empattement 4100mm / - distancia entre ejes 4100mm

²⁾ - wheel base 4100 mm / + passo 4100 mm / + empattement 4100 mm / + distancia entre ejes 4100 mm

³⁾ - FA 730.505/506 / - A 730.505/506 / - ess. AV 730.505/506 / - ED 730.505/506

⁴⁾ + FA 730.505/506 / + A 730.505/506 / + ess. AV 730.505/506 / + ED 730.505/506

⁵⁾ + wide design / + versione larga / + version large / + variante ancha

⁶⁾ - RA 741.203/302 / - P 741.203/302 / - ess. AR 741.203/302 / - ET 741.203/302

⁷⁾ + RA 741.203/302 / + P 741.203/302 / + ess. AR 741.203/302 / + ET 741.203/302

⁸⁾ + single circuit brake / + impianto freni circuito singolo / + frein à 1 circuit / + freno de 1 circuito

⁹⁾ + two circuit brake / + impianto frenante doppio circuito / + frein à deux circuits / + freno de 2 circuitos

¹⁰⁾ in connection head / nella testa di collegamento / dans tête de raccordement / en culata de conexión

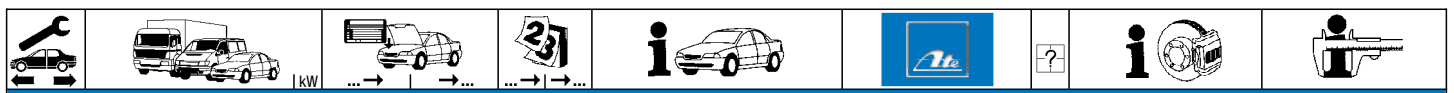

MERCEDES BENZ BUS (BM 322) O 322

	O 322			01.62	12.63		03.3134-0300.3	010308	Ersatz für Hz 38,10 ¹⁾	Hz 34,92	ATE
							03.0370-1038.2	051038	+ Hz 38,10 ²⁾	Hz Reparatursatz	
							03.0370-9998.2	059998	+ Hz 38,10 ²⁾	Hz Rep. Satz, -Kolben	ATE
	O 322			01.59	12.64		03.3508-0501.3	310017	+ Hz 31,75/ 0,35 l ³⁾	Behälter	
	O 322			01.64			03.3508-0401.3	310014		Behälter	
	O 322			01.59			83.6103-0450.3	330228		L=450	
	O 322			01.59			83.6103-0550.3	330231		L=550	
	O 322			01.59			83.6123-0381.3	330262		L=380	
							83.6103-0400.3	330226		L=400	
	O 322			01.59			83.6103-0500.3	330230		L=500	

MERCEDES BENZ BUS (BM 352) OF 1313/1317/1413/1417

	OF 1313			01.68	12.69		03.3508-0264.3	310009		Behälter	
	OF 1317			01.68	12.69						
	OF 1413			01.68	12.69						
	OF 1417			01.68	12.69						
	OF 1313			01.68	12.69		83.6133-0551.3	330273		L=550	
	OF 1317			01.68	12.69						
	OF 1413			01.68	12.69						
	OF 1417			01.68	12.69						

MERCEDES BENZ BUS (BM 358) OF 1113 B

	OF 1113 B		4487194	01.68			03.3508-0264.3	310009		Behälter	
	OF 1113 B		4487195		12.69		03.3509-0100.3	310057		Behälter	
	OF 1113 B			01.68	12.69		83.6133-0551.3	330273		L=550	
	OF 1113 B		4134171		12.69		83.6133-0651.3	330274		L=650	

MERCEDES BENZ LKW (BM 314) 608/709

	LP 608		4282707	01.65			03.3508-0264.3	310009		Behälter	
	LP 608			01.65	12.78		83.6133-0551.3	330273		L=550	
	LP 709			01.78							
	LPL 608			01.76	12.78						
	LPL 709			01.78							
	LPO 608			01.65	12.78						
	LPO 709			01.78							
	LPS 608			01.65	12.78	BM 314.062					
	LP 608			01.65	12.78		83.6133-0500.3	330272		L=500	
	LP 709			01.78							
	LPL 608			01.76	12.78						
	LPL 709			01.78							
	LP 608			01.65	12.78		24.2419-0937.3	030063		Gz 19,05	FTE
	LP 709			01.78			03.0350-1926.2	071926	+ ATE-Zylinder ⁴⁾	Gz Reparatursatz	ATE
	LPL 608			01.76	12.78						
	LPL 709			01.78							
	LP 608			01.65	12.78		03.0450-2805.2	082805		Nz Reparatursatz	
	LP 709			01.78							
	LPL 608			01.76	12.78						
	LPL 709			01.78							

MERCEDES BENZ LKW (BM 316) 808/809

	LP 808		4282707	01.67			03.3508-0264.3	310009	separater Behälter ⁵⁾	Behälter	
	LP 808			01.67	12.78		83.6133-0551.3	330273		L=550	
	LP 809			01.78							
	LPL 808			01.76	12.78						
	LPL 809			01.78							
	LPO 808			01.67	12.78						
	LPO 809			01.78							
	LP 808			01.67	12.78		03.3241-1801.3	020130	+ Druckbolzen ⁶⁾	Rz 41,27	
	LP 809			01.78			03.0403-0341.2	060031	+ Rz mit schrägem Anschluß ⁷⁾	Rz Reparatursatz	
	LPL 808			01.76	12.78						
	LPL 809			01.78							
	LPO 808			01.67	12.78						
	LPO 809			01.78							
	LP 808			01.67	12.78		83.6133-0500.3	330272		L=500	
	LP 809			01.78							
	LPL 808			01.76	12.78						
	LPL 809			01.78							
	LPO 808			01.67	12.78						
	LPO 809			01.78							

¹⁾ replacement for MC 38,10 / ricambio per PF 38,10 / remplacement pour MC 38,10 / sustitución para CM 38,10

²⁾ + MC 38,10 / + PF 38,10 / + MC 38,10 / + CM 38,10

³⁾ + MC 31,75/ 0,35 l / + PF 31,75/ 0,35 l / + MC 31,75/ 0,35 l / + CM 31,75/ 0,35 l















⁴⁾ + ATE cylinder / + ATE - frizione idraulica / + cylindre ATE / + cilindrico de ATE

⁵⁾ separate reservoir / serbatoio separato / réservoir séparé / depósito independiente











⁶⁾ + tappet / + punteria / + boulon de pression / + perno de presión

⁷⁾ + WC with vertical connection / + CR con attacco verticale / + CR avec raccord oblique / + CR con conexión oblicua



MERCEDES BENZ LKW (BM 316) 808/809											
	LP 808 LP 809 LPL 808 LPL 809 LPO 808 LPO 809			01.67 01.78 01.76 01.78 01.67 01.78	12.78 12.78		03.3241-1801.3 03.0403-0341.2	020130 060031	+ Druckbolzen ¹⁾ + Rz mit schrägem Anschluß ²⁾	Rz 41,27 Rz Reparatursatz	
	LP 808 LP 809 LPL 808 LPL 809			01.67 01.78 01.76 01.78	12.78 12.78		24.2419-0937.3 03.0350-1926.2	030063 071926	+ ATE-Zylinder ³⁾	Gz 19,05 Gz Reparatursatz	FTE ATE
	LP 808 LP 809 LPL 808 LPL 809			01.67 01.78 01.76 01.78	12.78 12.78		03.0450-2805.2	082805		Nz Reparatursatz	
MERCEDES BENZ LKW (BM 318) 811-1113											
	LP 811 LP 813 LP 913	4282707 4282707 4282707		01.71 01.71 01.71			03.3508-0264.3	310009		Behälter	
	LP 1013 LP 811 LP 813 LP 913 LPL 1013 LPL 813 LPL 913 LPO 811 LPO 813			01.76 01.71 01.71 01.71 01.77 01.76 01.77 01.71 01.71	12.78 12.78		83.6133-0551.3	330273		L=550	
	LP 1013 LP 811 LP 813 LP 913 LPL 1013 LPL 813 LPL 913 LPO 811 LPO 813			01.76 01.71 01.71 01.71 01.77 01.76 01.77 01.71 01.71	12.78 12.78	- VA 730.705 ⁴⁾ - VA 730.705 ⁴⁾ - VA 730.705 ⁴⁾ - VA 730.705 ⁴⁾ - VA 730.705 ⁴⁾ - VA 730.705 ⁴⁾	03.3241-1801.3 03.0403-0341.2	020130 060031	+ Druckbolzen ¹⁾ + Rz mit schrägem Anschluß ²⁾	Rz 41,27 Rz Reparatursatz	
	LP 1013 LP 811 LP 813 LP 913 LPL 1013 LPL 813 LPL 913 LPO 811 LPO 813			01.76 01.71 01.71 01.71 01.77 01.76 01.77 01.71 01.71	12.78 12.78		83.6133-0500.3	330272		L=500	
	LP 1013 LP 811 LP 813 LP 913 LPL 1013 LPL 813 LPL 913 LPO 811 LPO 813			01.76 01.71 01.71 01.71 01.77 01.76 01.77 01.71 01.71	12.78 12.78		83.6103-0500.3	330230		L=500	
	LP 1013 LP 811 LP 813 LP 913 LPL 1013 LPL 813 LPL 913 LPO 811 LPO 813			01.76 01.71 01.71 01.71 01.77 01.76 01.77 01.71 01.71	12.78 12.78	- HA 730.310/311 ⁵⁾ - HA 730.310/311 ⁵⁾ - HA 730.310/311 ⁵⁾ - HA 730.310/311 ⁵⁾ - HA 730.310/311 ⁵⁾ - HA 730.310/311 ⁵⁾	03.3241-1801.3 03.0403-0341.2	020130 060031	+ Druckbolzen ¹⁾ + Rz mit schrägem Anschluß ²⁾	Rz 41,27 Rz Reparatursatz	
	LP 1013 LP 1113 LP 811 LP 813 LP 913 LPL 1013 LPL 1113 LPL 813 LPL 913			01.76 01.78 01.71 01.71 01.71 01.77 01.78 01.76 01.77	12.78 12.78		24.2419-0937.3 03.0350-1926.2	030063 071926	+ ATE-Zylinder ³⁾	Gz 19,05 Gz Reparatursatz	FTE ATE
	LP 1013 LP 1113 LP 811 LP 813 LP 913 LPL 1013 LPL 1113 LPL 813 LPL 913			01.76 01.78 01.71 01.71 01.71 01.77 01.78 01.76 01.77	12.78 12.78		03.0450-2805.2	082805		Nz Reparatursatz	
MERCEDES BENZ LKW (BM 323) 710											
	L 710 LA 710			01.63 01.63	12.69 12.69	+ 1-Kreis-Bremse ⁶⁾ + 1-Kreis-Bremse ⁶⁾	03.0370-1131.2	051131		Hz Reparatursatz	
	L 710 LA 710			01.63 01.63	12.69 12.69	+ 2-Kreis-Bremse ⁷⁾ + 2-Kreis-Bremse ⁷⁾	03.3318-0800.2	390112	2	im Anschlußkopf ⁸⁾	Bodenventil
	L 710 LA 710			01.63 01.63	12.69 12.69		03.3508-0501.3	310017		0,35 l	Behälter

1) + tappet / + punteria / + boulon de pression / + perno de presión
2) + WC with vertical connection / + CR con attacco verticale / + CR avec raccord oblique / + CR con conexión oblicua
3) + ATE cylinder / + ATE - frizione idraulica / + cylindre ATE / + cilindro de ATE
4) - FA 730.705 / - A 730.705 / - ess. AV 730.705 / - ED 730.705
5) - RA 730.310/311 / - P 730.310/311 / - ess. AR 730.310/311 / - ET 730.310/311
6) + single circuit brake / + impianto freni circuito singolo / + frein à 1 circuit / + freno de 1 circuito
7) + two circuit brake / + impianto frenante doppio circuito / + frein à deux circuits / + freno de 2 circuitos
8) in connection head / nella testa di collegamento / dans tête de raccordement / en culata de conexión

MERCEDES BENZ LKW (BM 323) 710										
	L 710			01.63	12.69		83.6133-0551.3	330273		L=550
	LA 710		011912	01.63			83.6133-0651.3	330274		L=650
	L 710			01.63	12.69		83.6133-0500.3	330272		L=500
	LA 710			01.63	12.69		83.6133-0651.3	330274		L=650
MERCEDES BENZ LKW (BM 328) 911										
	L 911		027672	01.63	+ (E)		03.0370-1131.2	051131		Hz Reparatursatz
	L 911			01.63	12.68	+ 1-Kreis-Bremse/ - (E) ¹⁾				
	LA 911		027672	01.63	+ (E)					
	LA 911			01.63	12.68	+ 1-Kreis-Bremse/ - (E) ¹⁾				
	L 911	027673			12.68	+ (E)	03.0370-1038.2	051038		Hz Reparatursatz
	LA 911	027673			12.68	+ (E)	03.0370-9998.2	059998		Hz Rep. Satz,-Kolben ATE
	L 911			01.63	12.68	+ 2-Kreis-Bremse ²⁾				
	LA 911			01.63	12.68	+ 2-Kreis-Bremse ²⁾	03.3318-0800.2	390112	2	im Anschlußkopf ³⁾
	L 911		027672	01.63	+ (E)		03.3508-0501.3	310017	0,35 l	Behälter
	L 911			01.63	12.68	+ 1-Kreis-Bremse/ - (E) ¹⁾				
	LA 911		027672	01.63	+ (E)					
	LA 911			01.63	12.68	+ 1-Kreis-Bremse/ - (E) ¹⁾				
	L 911			01.63	12.68		83.6133-0551.3	330273		L=550
	L 911			01.63	12.68		83.6133-0500.3	330272		L=500
	LA 911			01.63	12.68		83.6133-0651.3	330274		L=650
MERCEDES BENZ LKW (BM 338) 1418										
	1418 L		002072	01.60			03.0370-1131.2	051131		Hz Reparatursatz
	1418 LK		002072	01.60						
	1418 LP		000785	01.60						
	1418 LPS		000785	01.60						
	1418 LS		002072	01.60						
	1418 L	002073			12.72		03.3134-0300.3	010308		Hz 34,92 ATE
	1418 LK	002073			12.72					
	1418 LP	000786			12.72					
	1418 LPS	000786			12.72					
	1418 LS	002073			12.72					
	1418 L			01.60	12.72		03.3508-0501.3	310017	0,35 l	Behälter
	1418 LK			01.60	12.72					
	1418 LP			01.60	12.72					
	1418 LPS			01.60	12.72					
	1418 LS			01.60	12.72					
	1418 L			01.60	12.72		83.6133-0500.3	330272		L=500
	1418 LK			01.60	12.72					
	1418 LP			01.60	12.72	+ Radstand 3700mm ⁴⁾	83.6133-0551.3	330273		L=550
	1418 LP			01.60	12.72	+ Radstand 4200/5000mm ⁵⁾	83.6133-0500.3	330272		L=500
	1418 LP	000786	001207		12.72	+ Radstand 4200/5000mm ⁵⁾	83.6133-0551.3	330273		L=550
	1418 LP	001208			12.72	+ Radstand 4200/5000mm ⁵⁾	83.6133-0500.3	330272		L=500
	1418 LPS		001235	01.60			83.6133-0551.3	330273		L=550
	1418 LS	003366			12.72		83.6133-0551.3	330273		L=550
MERCEDES BENZ LKW (BM 352) 1213/1216/1313/1317/1319/1813										
	1813 L 6x2			01.68	12.71		03.3138-2001.3	010310	+ Vorderachse + 2. HA ⁶⁾	Hz 38,10 ATE
	1813 L 6x4			01.68	12.71		03.0370-1038.2	051038	+ Vorderachse + 2. HA ⁶⁾	Hz Reparatursatz
	1813 L 6x4			01.68	12.71		03.0370-9998.2	059998	+ Vorderachse + 2. HA ⁶⁾	Hz Rep. Satz,-Kolben ATE
	1213 LP			01.65	12.67		03.3508-0401.3	310014	0,13 l	Behälter
	1216 LP			01.66	12.67		03.3508-0264.3	310009	im Fahrerhaus ⁷⁾	Behälter
	1216 LPS			01.66	12.67					
	1313 L			01.67						
	1313 LA			01.67						
	1313 LAKO			01.67						
	1313 LP			01.67	12.76					
	1317 LP			01.67	12.70					
	1317 LPS			01.67	12.70					
	1319 LP			01.70	12.76					
	1319 LPS			01.70	12.76					
	1813 L 6x2			01.68	12.71		03.3508-0401.3	310014	+ 1. Hinterachse ⁸⁾	Behälter
	1813 L 6x4			01.68	12.71		03.3508-0801.3	310023	+ Vorderachse + 2. HA ⁶⁾	Behälter
	1213 LP			01.65	12.67		83.6133-0551.3	330273		L=550
	1216 LP			01.66	12.67					
	1216 LPS			01.66	12.67					
	1313 L			01.67						
	1313 LP			01.67	12.76					
	1317 LP			01.67	12.70					
	1317 LPS			01.67	12.70					
	1319 LP			01.70	12.76					
	1319 LPS			01.70	12.76					
	1313 LA			01.67			83.6103-0600.3	330233		L=600
	1313 LAKO			01.67						
	1813 L 6x2			01.68	12.71		83.6133-0551.3	330273		L=550
	1813 L 6x4			01.68	12.71					

¹⁾ + single circuit brake/ - (E) / + impianto fr.circ.semp./ - (E) / + frein à 1 circuit/ - (E) / + freno de 1 circuito/ - (E)

²⁾ + two circuit brake / + impianto frenante doppio circuito / + frein à deux circuits / + freno de 2 circuitos

³⁾ in connection head / nella testa di collegamento / dans tête de raccordement / en culata de conexión



























⁴⁾ + wheel base 3700 mm / + passo 3700 mm / + empattement 3700 mm / + distancia entre ejes 3700 mm

⁵⁾ + wheel base 4200/5000 mm / + passo 4200/5000 mm / + empattement 4200/5000 mm / + dist.entre ejes 4200/5000 mm

⁶⁾ + front axle + 2. rear axle / + ass.anterior. + 2. ass.posterior. / + ess.avant et 2. ess.arrière / + eje delant. + 2.eje trasero

⁷⁾ in cab / in cabina / dans la cabine du conducteur / en cabina

⁸⁾ + 1. rear axle / + 1. asse posteriore / + 1. essieu arrière / + 1. eje trasero

MERCEDES BENZ LKW (BM 352) 1213/1216/1313/1317/1319/1813											
											
	1317 LPS 1319 LPS			01.67 01.70	12.70 + BM 352.086 12.76 + BM 352.086	83.6103-0600.3	330233			L=600	
	1313 LA 1313 LAK0 1813 L 6x2 1813 L 6x4			01.67 01.67 01.68 01.68	12.71 12.71	83.6133-0651.3	330274			L=650	
MERCEDES BENZ LKW (BM 353) 810/911 B											
	L 911 B LA 911 B LP 810 LP 911 B LT 911 B	601116 601116		01.68 01.68	12.68 12.75	03.3138-2001.3 03.0370-1038.2 03.0370-9998.2	010310 051038 059998			Hz 38,10 Hz Reparatursatz Hz Rep. Satz, -Kolben	ATE ATE
	LP 810 LP 911 B L 911 B LA 911 B LP 810 LP 911 B LT 911 B	601115 601116 601116		01.65 01.68 01.68 01.68	12.68 12.75	03.3134-0300.3 03.3508-0264.3 03.3508-0801.3	010308 310009 310023			Hz 34,92 Behälter Behälter	ATE
	L 911 B LP 810 LP 911 B LA 911 B LT 911 B			01.68 01.65 01.68	12.68 12.75	83.6133-0551.3	330273			L=550 L=650	
	LA 911 B			01.68		83.6133-0651.3	330274			L=650	
	LA 911 B			01.68		83.6133-0651.3	330274			L=650	
MERCEDES BENZ LKW (BM 354) 1418/1424											
	1418 LP 1418 LPS 1424 LP 1424 LPS			01.64 01.64 01.73 01.73	12.72 12.72 12.83 12.83	03.0370-1131.2	051131			Hz Reparatursatz	
	1418 LP 1418 LPS 1424 LP 1424 LPS			01.64 01.64 01.73 01.73	12.72 12.72 12.83 12.83	03.3508-0501.3	310017	2		Behälter	
	1418 LP 1418 LPS 1424 LP 1424 LPS			01.64 01.64 01.73 01.73	12.72 12.72 12.83 12.83	83.6133-0551.3	330273			L=550	
MERCEDES BENZ LKW (BM 355) 2219											
	LP 2219 6x4			01.72	12.75	03.3138-2001.3 03.3134-0300.3 03.0370-1038.2 03.0370-9998.2	010310 010308 051038 059998			+ Vorderachse ¹⁾ + Hinterachse ²⁾ Hz 38,10 Hz 34,92 Hz Reparatursatz Hz Rep. Satz, -Kolben	ATE ATE ATE
	LP 2219 6x4			01.72	12.75	03.3508-0801.3	310023			+ Hinterachse ²⁾ Behälter	
	LP 2219 6x4			01.72	12.75	83.6133-0551.3	330273			L=550	
	LP 2219 6x4			01.72	12.75	83.6133-0651.3	330274			L=650	
MERCEDES BENZ LKW (BM 358) 1013/1113 B											
	L 1113 B LA 1113 B LF 1113 B LKO 1113 B LP 1013 LP 1113 B	603469 603469		01.68 01.68 01.68 01.68	12.68	03.3134-0300.3	010308			Hz 34,92	ATE
	LP 1013 LP 1113 B L 1113 B LA 1113 B LF 1113 B LKO 1113 B LP 1013 LP 1113 B	603468 603468 603469 603469	603468 603468	01.65 01.68 01.68 01.68 01.68	12.68	03.3508-0401.3 03.3508-0264.3 03.3508-0801.3 03.3508-0264.3 03.3508-4903.3	310014 310009 310023 310009 310032			im Fahrerhaus ³⁾ Behälter Behälter Behälter Behälter	
	L 1113 B LF 1113 B LKO 1113 B LP 1013 LP 1113 B LA 1113 B			01.68 01.68 01.68 01.65 01.68	12.68	83.6133-0551.3	330273			L=550	
	LA 1113 B			01.68		83.6133-0651.3	330274			L=650	
	LA 1113 B			01.68		83.6133-0651.3	330274			L=650	

¹⁾ + front axle / + asse anteriore / + essieu avant / + eje delantero

²⁾ + rear axle / + asse posteriore / + essieu arrière / + eje trasero

³⁾ in cab / in cabina / dans la cabine du conducteur / en cabina

⁴⁾ 0,2 l, in cab / 0,2 l, in cabina / 0,2l,dans cabine du conducteur / 0,2 l, en cabina

⁵⁾ 0,5 l, in cab / 0,5 l, in cabina / 0,5l,dans cabine du conducteur / 0,5 l, en cabina

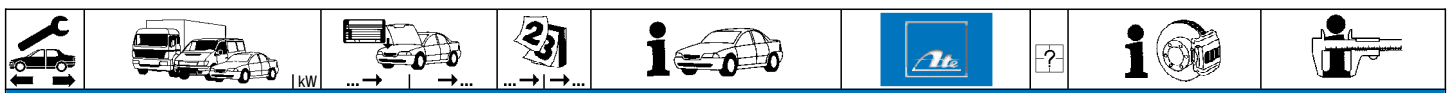

MERCEDES BENZ LKW (BM 360) 1513/1517/1519/1817/1819/2219

	1817 L 6x4 1819 L 6x4		01.69 01.69	12.71 12.71		03.3138-2001.3 03.0370-1038.2 03.0370-9998.2	010310 051038 059998	+ Vorderachse + 2. HA ¹⁾ + Vorderachse + 2. HA ¹⁾ + Vorderachse + 2. HA ¹⁾	Hz 38,10 Hz Reparatursatz Hz Rep. Satz, -Kolben	ATE ATE
	1513 L 1513 LA 1513 LP 1517 L 1517 LA 1517 LP 1519 L 1519 LA 1519 LP 2219 LP 6x2		01.67 01.67 01.67 01.67 01.67 01.67 01.71 01.71 01.71 01.72	12.75 12.70 12.70 12.78 12.78 12.78 12.78 12.78		03.3508-0401.3 03.3508-0264.3	310014 310009	0,13 l separater Behälter ²⁾	Behälter Behälter	
	1817 L 6x4 1819 L 6x4		01.69 01.69	12.71 12.71		03.3508-0401.3 03.3508-0801.3	310014 310023	+ 1. Hinterachse ³⁾ + Vorderachse + 2. HA ¹⁾	Behälter Behälter	
	1513 L 1513 LP 1517 L 1517 LP 1519 L 1519 LP 1817 L 6x4 1819 L 6x4 2219 LP 6x2		01.67 01.67 01.67 01.67 01.71 01.71 01.69 01.69 01.72	12.75 12.70 12.70 12.70 12.78 12.78 12.71 12.71 12.75		83.6133-0551.3	330273		L=550	
	1513 LA 1517 LA 1519 LA		01.67 01.67 01.71	12.70 12.70 12.78		83.6133-0651.3	330274		L=650	
	1513 LA 1517 LA 1519 LA 2219 LP 6x2		01.67 01.67 01.71 01.72	12.70 12.70 12.78 12.75		83.6133-0651.3 83.6133-0500.3	330274 330272		L=650 L=500	

MERCEDES BENZ LKW (BM 380) 1013/1017/1019

	1013 1017 1017 F 1017 K 1017 LS 1017 S 1019 F		01.76 01.76 01.76 01.76 01.77 01.76 01.76			83.6133-0651.3 83.6133-0651.3	330274 330274		L=650 L=650	
	1013 1013 A 1017 1017 A 1017 AF 1017 AK 1017 AS 1017 F 1017 K 1017 LS 1017 S 1019 AF 1019 F		01.76 01.76 01.76 01.76 01.76 01.76 01.76 01.76 01.76 01.77 01.76 01.76 01.76 01.76		- VA 731.404/600/632-635 ⁵⁾ - VA 731.404/600/632-635 ⁵⁾ - VA 731.404/600/632-635 ⁵⁾ - VA 731.635 ⁶⁾	24.3244-0904.3	020301	Druckbolzen kurz ⁴⁾	Rz 44,45	
	1013 1017 1017 LS 1019 AF 1019 F		01.76 01.76 01.77 01.78 01.78			03.2423-0603.3	030036		Gz 23,81	
	1019 AF 1019 F		01.78 01.78			03.2538-0104.3 03.0450-3801.2	040035 083801		Nz 38,10 Nz Reparatursatz	
	1013 1017 1017 LS 1019 AF 1019 F		01.76 01.76 01.77 01.78 01.78			24.5901-0517.3	330054		L=517	











MERCEDES BENZ LKW (BM 381) 1213/1217/1219

	1213 1217 1217 L 1217 LS 1219 1219 AF 1219 F 1219 S	4393715	01.76 01.76 01.76 01.76 01.76 01.76 01.76 01.76			83.6133-0651.3	330274		L=650	
	1213 1213 A 1217 1217 A 1217 A 1217 L 1217 LS 1219 S		01.76 01.76 01.76 01.76 01.76 01.76 01.76 01.76		- VA 731.404/633/635 ⁷⁾ - VA 731.404/406/600 ⁸⁾ - VA 731.632/634/635 ⁹⁾ + VA 730.009 ¹⁰⁾	24.3244-0904.3	020301	Druckbolzen kurz ⁴⁾	Rz 44,45	

¹⁾ + front axle + 2. rear axle / + ass.anterior.+ 2.ass.posterior. / + ess.avant et 2. ess.arrière / + eje delant.+ 2.eje trasero
²⁾ separate reservoir / serbatoio separato / réservoir séparé / depósito independiente
³⁾ + 1. rear axle / + 1. asse posteriore / + 1. essieu arrière / + 1. eje trasero
⁴⁾ tappet short / punteria corta / boulon de pression court / perno de presión (corto)
⁵⁾ - FA 731.404/600/632-635 / - A 731.404/600/632-635 / - ess. AV 731.404/600/632-635 / - ED 731.404/600/632-635
⁶⁾ - FA 731.635 / - A 731.635 / - ess. AV 731.635 / - ED 731.635
⁷⁾ - FA 731.404/633/635 / - A 731.404/633/635 / - ess. AV 731.404/633/635 / - ED 731.404/633/635











⁸⁾ - FA 731.404/406/600 / - A 731.404/406/600 / - ess. AV 731.404/406/600 / - ED 731.404/406/600
⁹⁾ - FA 731.632/634/635 / - A 731.632/634/635 / - ess. AV 731.632/634/635 / - ED 731.632/634/635
¹⁰⁾ + FA 730.009 / + A 730.009 / + ess. AV 730.009 / + ED 730.009



























MERCEDES BENZ LKW (BM 381) 1213/1217/1219											
	1213 1217 1217 L 1217 LS 1219			01.76 01.76 01.76 01.76 01.76			03.2423-0603.3	030036		Gz 23,81	
	1219			01.76			03.2538-0104.3 03.0450-3801.2	040035 083801		Nz 38,10 Nz Reparatursatz	
	1213 1217 1217 L 1217 LS 1219			01.76 01.76 01.76 01.76 01.76			24.5901-0517.3	330054		L=517	
MERCEDES BENZ LKW (BM 383) 1413/1417/1419/1424											
	1413 1417 1419 1419 F 1419 L 1419 LS 1424 1424 F			01.75 01.75 01.75 12.83 01.75 12.83 01.75 12.83 01.75 12.83 01.73 12.83 01.73 12.83			83.6133-0651.3	330274		L=650	
	1413 1417 1419 1419 L 1424 1424 F			01.75 12.85 01.75 12.85 01.75 12.83 01.75 12.83 01.75 12.83 01.75 12.83			03.2423-0603.3	030036		Gz 23,81	
	1419 1419 L 1424 1424 F			01.75 12.83 01.75 12.83 01.75 12.83 01.75 12.83			03.2538-0104.3 03.0450-3801.2	040035 083801		Nz 38,10 Nz Reparatursatz	
	1413 1417 1419 1419 L 1424 1424 F			01.75 12.85 01.75 12.85 01.75 12.83 01.75 12.83 01.75 12.83 01.75 12.83			24.5901-0517.3	330054		L=517	
MERCEDES BENZ LKW (BM 385) 1613/1617/1619/1624/2219/2224											
	2219 6x2 2219 L 6x2 2224 6x2			01.76 12.83 01.76 12.83 01.69 12.83			03.3134-0300.3 03.0370-1131.2	010308 051131	+ Vorderachse ¹⁾ + Hinterachse ²⁾	Hz 34,92 Hz Reparatursatz	ATE
	2219 6x4 2224 6x4 2224 B 6x4	4270668 4270668 4270668		01.75 01.69 01.69			03.3134-0300.3	010308	+ Vorderachse ¹⁾	Hz 34,92	ATE
	2219 6x4 2224 6x4 2224 B 6x4	4270669 4270669 4270669		12.83 12.75 12.78			03.0370-1131.2	051131	+ Vorderachse ¹⁾	Hz Reparatursatz	
	1613 1613 K 1613 L 1617 1617 K 1617 L 1619 1619 L 1624 1624 L 2219 6x2 2219 6x4 2219 L 6x2 2224 6x2 2224 6x4			01.75 12.85 01.75 12.85 01.75 12.85 01.75 12.83 01.75 12.83 01.75 12.83 01.75 12.83 01.75 12.83 01.75 12.83 01.76 12.83 01.75 12.83 01.76 12.83 01.69 12.83 01.69 12.75			83.6133-0651.3	330274		L=650	
	2219 6x2 2219 6x4 2224 6x2 2224 6x4 2224 B 6x4			01.76 12.83 01.75 12.83 01.69 12.83 01.69 12.75 01.69 12.78			83.6133-0651.3	330274		L=650	
	1613 1613 K 1613 L 1617 AK 1617 K 1617 L 1617 S 1619 1619 L 1624 1624 L 2219 6x2 2219 6x4 2219 L 6x2 2224 6x2 2224 6x4			01.75 12.85 01.75 12.85 01.75 12.85 01.75 12.85 01.75 12.85 01.75 12.85 01.75 12.83 01.75 12.83 01.75 12.83 01.75 12.83 01.76 12.83 01.76 12.83 01.76 12.83 01.69 12.83 01.69 12.83			03.2423-0603.3	030036		Gz 23,81	

¹⁾ + front axle / + asse anteriore / + essieu avant / + eje delantero
²⁾ + rear axle / + asse posteriore / + essieu arrière / + eje trasero



										
MERCEDES BENZ LKW (BM 385) 1613/1617/1619/1624/2219/2224										
	1619 1619 L 1624 1624 L 2219 6x2 2219 6x4 2219 L 6x2 2224 6x2 2224 6x4			01.75 01.75 01.75 01.76 01.76 01.76 01.69 01.69	12.83 12.83 12.83 12.83 12.83 12.83 12.83 12.83			03.2538-0104.3 03.0450-3801.2	040035 083801	Nz 38,10 Nz Reparatursatz
	1613 1613 K 1613 L 1617 AK 1617 K 1617 L 1617 S 1619 1619 L 1624 1624 L 2219 6x2 2219 6x4 2219 L 6x2 2224 6x2 2224 6x4			01.75 01.75 01.75 01.75 01.75 01.75 01.75 01.75 01.75 01.75 01.75 01.76 01.76 01.76 01.69 01.69	12.85 12.85 12.85 12.85 12.85 12.85 12.83 12.83 12.83 12.83 12.83 12.83 12.83 12.83 12.83 12.83			24.5901-0517.3	330054	L=517
MERCEDES BENZ LKW (BM 387) 1626/1632/1719										
	1626 1626 L 1632 1632 L 1719 1719 AK 1719 K 1719 S			01.73 01.76 01.73 01.76 01.73 01.73 01.73 01.73	12.80 12.80 12.82 12.82 12.81 12.81 12.81 12.81			03.2423-0603.3	030036	Gz 23,81
	1626 1626 L 1632 1632 L 1719 1719 AK 1719 K 1719 S			01.73 01.76 01.73 01.76 01.73 01.73 01.73 01.73	12.80 12.80 12.82 12.82 12.81 12.81 12.81 12.81			03.2538-0104.3 03.0450-3801.2	040035 083801	Nz 38,10 Nz Reparatursatz
	1626 1626 L 1632 1632 L			01.73 01.76 01.73 01.76	12.80 12.80 12.82 12.82			24.5901-0517.3	330054	L=517
	1719 1719 AK 1719 K 1719 S			01.73 01.73 01.73 01.73	12.81 12.81 12.81 12.81			24.5901-0517.3	330054	L=517
MERCEDES BENZ LKW (BM 389) 1919/1926/1932										
	1919 1919 AK 1919 K 1919 S 1926 1932 1932 L			01.73 01.73 01.73 01.73 01.73 01.73 01.73				03.2423-0603.3	030036	Gz 23,81
	1919 1919 AK 1919 K 1919 S 1926 1932 1932 L			01.73 01.73 01.73 01.73 01.73 01.73 01.73				03.2538-0104.3 03.0450-3801.2	040035 083801	Nz 38,10 Nz Reparatursatz
	1919 1919 K 1919 S			01.73 01.73 01.73				24.5901-0517.3	330054	L=517
	1919 AK 1926 1932 1932 L			01.73 01.73 01.73 01.73				24.5901-0517.3	330054	L=517
MERCEDES BENZ LKW (BM 391) 2026/2032										
	2026 2032 2032 S			01.76 01.76 01.76	12.81			03.2423-0603.3	030036	Gz 23,81
	2026 2032 2032 S			01.76 01.76 01.76	12.81			03.2538-0104.3 03.0450-3801.2	040035 083801	Nz 38,10 Nz Reparatursatz

MERCEDES BENZ LKW (BM 391) 2026/2032										
	2026 2032 2032 S			01.76 01.76 01.76	12.81		24.5901-0517.3	330054		L=517
MERCEDES BENZ LKW (BM 393) 2226/2232										
	2226 6x2 2226 6x4 2226 L 6x2 2226 L 6x4 2232 6x2 2232 6x4			01.73 01.73 01.73 01.73 01.73 01.73	12.81 12.81 12.81 12.81 12.83 12.83		03.2423-0603.3	030036		Gz 23,81
	2226 6x2 2226 6x4 2226 L 6x2 2226 L 6x4 2232 6x2 2232 6x4			01.73 01.73 01.73 01.73 01.73 01.73	12.81 12.81 12.81 12.81 12.83 12.83		03.2538-0104.3 03.0450-3801.2	040035 083801		Nz 38,10 Nz Reparatursatz
	2226 6x2 2226 6x4 2226 L 6x2 2226 L 6x4 2232 6x2 2232 6x4			01.73 01.73 01.73 01.73 01.73 01.73	12.81 12.81 12.81 12.81 12.83 12.83		24.5901-0517.3	330054		L=517
MERCEDES BENZ LKW (BM 395) 2626/2632										
	2626 6x4 2626 6x6 2632 6x4 2632 6x6			01.73 01.73 01.73 01.73	12.83 12.83 12.83 12.83		03.2423-0603.3	030036		Gz 23,81
	2626 6x4 2626 6x6 2632 6x4 2632 6x6			01.73 01.73 01.73 01.73	12.83 12.83 12.83 12.83		03.2538-0104.3 03.0450-3801.2	040035 083801		Nz 38,10 Nz Reparatursatz
	2626 6x4 2626 6x6 2632 6x4 2632 6x6			01.73 01.73 01.73 01.73	12.83 12.83 12.83 12.83		24.5901-0517.3	330054		L=517
MERCEDES BENZ LKW (BM 615) 1222										
	1222 1222 A 1222 AF 1222 F 1222 S			01.82 01.82 01.82 01.82 01.82			03.2423-0603.3	030036		Gz 23,81
	1222 1222 A 1222 AF 1222 F 1222 S			01.82 01.82 01.82 01.82 01.82			03.2538-0104.3 03.0450-3801.2	040035 083801		Nz 38,10 Nz Reparatursatz
	1222 A 1222 AF			01.82 01.82			24.5901-0517.3	330054		L=517
MERCEDES BENZ LKW (BM 616) 1414/1417/1419/1422/1425										
	1414 1417 C 1419 C 1419 CL 1422 1422 F 1422 L 1422 LS 1422 S 1425 LS 1425 S			01.84 01.83 01.83 01.83 01.82 01.82 01.82 01.82 01.82 01.83 01.83			03.2423-0603.3	030036		Gz 23,81
	1417 C 1419 C 1419 CL			01.83 01.83 01.83			24.2528-0907.3	040054		Nz 28,57
	1414			01.84			24.5901-0517.3	330054		L=517
MERCEDES BENZ LKW (BM 617) 1614/1617/1619/1622/1625										
	1614 1617 C 1619 C 1622 1622 AK 1625			01.84 01.83 01.83 01.82 01.82 01.79			03.2423-0603.3	030036		Gz 23,81
	1617 C 1619 C			01.83 01.83			24.2528-0907.3	040054		Nz 28,57
	1622 1622 AK 1625			01.82 01.82 01.79			03.2538-0104.3 03.0450-3801.2	040035 083801		Nz 38,10 Nz Reparatursatz

MERCEDENZ LKW (BM 617) 1614/1617/1619/1622/1625										
	1614 1622 AK			01.84 01.82			24.5901-0517.3	330054		L=517
MERCEDENZ LKW (BM 619) 2025/2219/2222/2225										
	2025 S 6x2/4 2219 C 6x2 2219 C 6x2/4 2219 CL 6x2 2222 6x2 2222 6x2/4 2222 6x4 2222 B 6x4 2222 K 6x4 2222 L 6x2 2225 B 6x4			01.83 01.83 01.83 01.83 01.82 01.84 01.82 01.82 01.82 01.83 01.82			03.2423-0603.3	030036		Gz 23,81
	2025 S 6x2/4			01.83			03.2538-0104.3 03.0450-3801.2	040035 083801		Nz 38,10 Nz Reparatursatz
	2219 C 6x2 2219 C 6x2/4 2219 CL 6x2			01.83 01.83 01.83			24.2528-0907.3	040054		Nz 28,57
	2222 6x4 2222 B 6x4 2222 K 6x4			01.82 01.82 01.82			03.2538-0104.3 03.0450-3801.2	040035 083801		Nz 38,10 Nz Reparatursatz
MERCEDENZ LKW (BM 620) 1628/1633/1636/1638										
	1628 1628 L 1628 LS 1628 S 1633 1633 L 1633 LS 1633 S 1636 LS			01.79 01.79 01.79 01.79 01.81 01.81 01.81 01.81 01.83			03.2423-0603.3	030036		Gz 23,81
	1638 1638 LS 1638 S			01.79 01.81 01.79	12.86 12.86 12.86		24.2426-0902.3	030073		Gz 26,99
	1628 1628 L 1628 LS 1628 S			01.79 01.79 01.79 01.79			03.2538-0104.3 03.0450-3801.2	040035 083801		Nz 38,10 Nz Reparatursatz
	1628 1628 L 1628 LS 1628 S		4921176 4921176 4921176 4921176	01.79 01.79 01.79 01.79		- BM 620.562/563	24.5901-0517.3	330054		L=517
	1628 1628 L 1628 LS 1628 S	4921177 4921177 4921177 4921177				- BM 620.562/563	24.5901-0517.3	330054		L=517
	1633 1633 L 1633 LS 1633 S 1636 LS			01.81 01.83 01.81 01.81 01.83		+ BM 620.046 + BM 620.446 + BM 620.543 + BM 620.142/143	24.5901-0517.3	330054		L=517
MERCEDENZ LKW (BM 621) 1922/1928/1933/1936/1938										
	1922 1922 AK 1922 K 1922 S 1928 1928 A 1928 AK 1928 AS 1928 K 1928 L 1928 LS 1928 S 1933 1933 LS 1933 S 1936 1936 AK 1936 AS 1936 K 1936 S			01.80 01.82 01.80 01.80 01.79 01.80 01.80 01.80 01.79 01.80 01.80 01.79 01.80 01.80 01.80 01.81 01.81 01.83 01.81 01.81			03.2423-0603.3	030036		Gz 23,81
	1938 1938 S			01.80 01.80	12.84 12.84		24.2426-0902.3	030073		Gz 26,99
	1922 1922 AK 1922 K 1922 S 1928 1928 A 1928 AK			01.80 01.82 01.80 01.80 01.79 01.80 01.80			03.2538-0104.3 03.0450-3801.2	040035 083801		Nz 38,10 Nz Reparatursatz

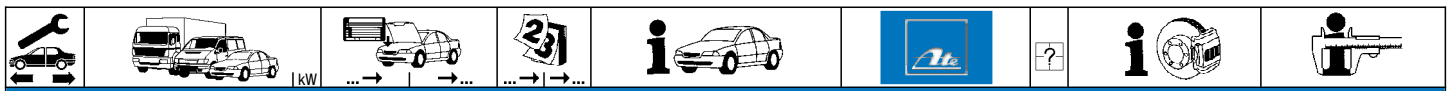

MERCEDES BENZ LKW (BM 621) 1922/1928/1933/1936/1938

	1928 AS 1928 K 1928 L 1928 LS 1928 S			01.80 01.79 01.80 01.80 01.79			03.2538-0104.3 03.0450-3801.2	040035 083801		Nz 38,10 Nz Reparatursatz
	1922 1922 AK 1922 K 1922 S			01.80 01.82 01.80 01.80			24.5901-0517.3	330054		L=517
	1928 1928 A 1928 AK 1928 AS 1928 K 1928 L 1928 LS 1928 S		4921176 4921176 4921176 4921176 4921176 4921176 4921176	01.79 01.80 01.80 01.80 01.79 01.80 01.80 01.79	- BM 621.066		24.5901-0517.3	330054		L=517
	1928 1928 A 1928 AK 1928 AS 1928 K 1928 L 1928 LS 1928 S	4921177 4921177 4921177 4921177 4921177 4921177 4921177			- BM 621.466 - BM 621.562 - BM 621.162/163		24.5901-0517.3	330054		L=517
	1933 1933 LS 1933 S 1936 1936 AK 1936 AS 1936 K 1936 S			01.80 01.80 01.80 01.81 01.81 01.83 01.81 01.81	- BM 621.096/097 - BM 621.192		24.5901-0517.3	330054		L=517

MERCEDES BENZ LKW (BM 622) 2028/2033

	2028 2033 LS 6x2/4			01.79 01.81			03.2423-0603.3	030036		Gz 23,81
	2028			01.79			03.2538-0104.3 03.0450-3801.2	040035 083801		Nz 38,10 Nz Reparatursatz
	2028			01.79	- BM 622.555		24.5901-0517.3	330054		L=517

MERCEDES BENZ LKW (BM 623) 2228/2233/2236/2238

	2228 6x2 2228 6x4 2228 L 6x2 2233 6x2 2233 6x4 2233 L 6x2 2233 S 6x4 2236 6x2			01.79 01.81 01.80 01.81 01.81 01.81 01.81 01.83	BM 623.023 BM 623.423 BM 623.423 BM 623.145		03.2423-0603.3	030036		Gz 23,81
	2238 6x2 2238 S 6x4			01.79 01.79	12.86 12.86		24.2426-0902.3	030073		Gz 26,99
	2228 6x2 2228 6x4 2228 L 6x2			01.79 01.81 01.80			03.2538-0104.3 03.0450-3801.2	040035 083801		Nz 38,10 Nz Reparatursatz
	2228 6x2 2228 6x4 2228 L 6x2		4921176 4921176 4921176	01.79 01.81 01.80	- BM 623.058 - BM 623.180 - BM 623.458		24.5901-0517.3	330054		L=517
	2228 6x2 2228 6x4 2228 L 6x2	4921177 4921177 4921177			- BM 623.058 - BM 623.180 - BM 623.458		24.5901-0517.3	330054		L=517
	2233 6x2 2233 6x4 2233 L 6x2 2233 S 6x4 2236 6x2			01.81 01.81 01.81 01.81 01.83	BM 623.023 BM 623.423 BM 623.423 BM 623.145		24.5901-0517.3	330054		L=517

MERCEDES BENZ LKW (BM 624) 2628/2633/2636/2638

	2628 6x4 2628 A 6x6 2628 AK 6x6 2628 AS 6x6 2628 B 6x4 2628 K 6x4 2628 S 6x4 2633 6x4 2633 S 6x4 2636 A 6x6 2636 AK 6x6 2636 AS 6x6 2636 K 6x4			01.80 01.80 01.80 01.80 01.80 01.80 01.80 01.81 01.81 01.81 01.81 01.81 01.81			03.2423-0603.3	030036		Gz 23,81
--	--	--	--	---	--	--	----------------	--------	--	----------



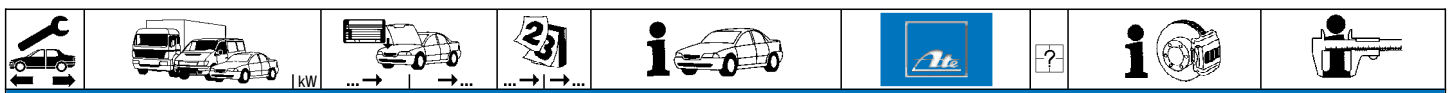

MERCEDES BENZ LKW (BM 624) 2628/2633/2636/2638

	2636 S 6x4			01.81		03.2423-0603.3	030036		Gz 23,81
	2638 S 6x4			01.81	12.86	24.2426-0902.3	030073		Gz 26,99
	2628 6x4			01.80		03.2538-0104.3	040035		Nz 38,10
	2628 A 6x6			01.80		03.0450-3801.2	083801		Nz Reparatursatz
	2628 AK 6x6			01.80					
	2628 AS 6x6			01.80					
	2628 B 6x4			01.80					
	2628 K 6x4			01.80					
	2628 S 6x4			01.80					
	2628 6x4		4921176	01.80		24.5901-0517.3	330054		L=517
	2628 A 6x6		4921176	01.80					
	2628 B 6x4		4921176	01.80					
	2628 K 6x4		4921176	01.80					
	2628 S 6x4		4921176	01.80					
	2628 6x4	4921177				24.5901-0517.3	330054		L=517
	2628 A 6x6	4921177		01.80					
	2628 AK 6x6			01.80					
	2628 B 6x4	4921177							
	2628 K 6x4	4921177							
	2628 S 6x4	4921177							
	2633 6x4			01.81					
	2633 S 6x4			01.81					
	2636 A 6x6			01.81					
	2636 AK 6x6			01.81					
	2636 AS 6x6			01.81					
	2636 K 6x4			01.81					
	2636 S 6x4			01.81					

MERCEDES BENZ LKW (BM 625) 3025/3028/3250/3328/3850

	3025 B 8x4			01.86	12.89	03.2423-0603.3	030036		Gz 23,81
	3025 K 8x4			01.86	12.89				
	3028 B 8x4			01.86					
	3028 K 8x4			01.86					
	3250 A 6x6			01.86	12.88				
	3328 B 8x4			01.86					
	3328 K 8x4			01.86					
	3850 A 6x6			01.85	12.88				
	3025 B 8x4			01.86		24.5901-0517.3	330054		L=517
	3025 K 8x4			01.86					
	3028 B 8x4			01.86		24.5901-0517.3	330054		L=517
	3028 K 8x4			01.86					
	3328 B 8x4			01.86					
	3328 K 8x4			01.86					

MERCEDES BENZ LKW 1413/1513

	1413 L			01.63	12.69	03.3134-0300.3	010308	+ 1-Kreis-Bremse ¹⁾	Hz 34,92	ATE
	1413 LA			01.63	12.69					
	1413 LP			01.63	12.67					
	1513 LB			01.67	12.69					
	1413 L			01.63	12.69	03.3508-0401.3	310014	+ 2-Kreis-Bremse ²⁾	Behälter	
	1413 LA			01.63	12.69					
	1413 LP			01.63	12.67					
	1513 LB			01.67	12.69					
	1413 L			01.63	12.69	83.6103-0550.3	330231		L=550	
	1413 LA			01.63	12.69					
	1413 LP			01.63	12.67					
	1513 LB			01.67	12.69					

MERCEDES BENZ Transporter (BM 309) L405-L410/L508

	alle Typen	162734		12.82	- Druckluftverstärker ³⁾	03.2122-4902.3	010144	Sekundärmanschette umdrehen	THz 22,20	ATE
						03.0370-3922.2	053922		THz Reparatursatz	
	alle Typen	162734		12.82	- Druckluftverstärker ³⁾	03.2122-2202.3	010140		THz 22,20	ATE
						03.0370-3922.2	053922		THz Reparatursatz	
	alle Typen				+ Druckluftverstärker ⁴⁾	03.2122-4902.3	010144		THz 22,20	ATE
						03.0370-3922.2	053922		THz Reparatursatz	
	alle Typen	002798		01.67		03.3508-0264.3	310009		Behälter	
	L 405 D			01.72		83.6133-0500.3	330272	2	L=500	
	L 406 DG			01.67	12.75					
	L 407 D			01.75						
	L 408 DG			01.68	12.75					
	L 408 G			01.67	12.75					
	L 409			01.75	12.82					
	L 410			01.82						
	L 508 D			01.75						
	L 508 DG			01.68	12.75					
	L 508 DG Kastenw.			01.77						
					BM 309.429/ Radstand 4100mm ⁵⁾					
	L 405 D	018261		12.80		03.3222-5804.3	020083		Rz 22,20	
	L 406 DG	018261		12.75						
	L 407 D			01.75						
	L 408 DG			01.68	12.75					
	L 408 G	001330		12.75						
	L 409			01.75	12.82					

¹⁾ + single circuit brake / + impianto freni circuito singolo / + frein à 1 circuit / + freno de 1 circuito
²⁾ + two circuit brake / + impianto frenante doppio circuito / + frein à deux circuits / + freno de 2 circuitos
³⁾ - air brake booster / - servofreno pneumatico / - amplificateur pneumatique / - servo de aire a presión
⁴⁾ + air brake booster / + servofreno pneumatico / + amplificateur pneumatique / + servo de aire a presión
⁵⁾ BM 309.429/wheel base 4100mm / BM 309.429/passo 4100mm / BM 309.429/empattem. 4100mm / BM 309.429/dist.ejes 4100mm





MERCEDES BENZ Transporter (BM 309) L405-L410/L508

	L 410 L 508 D L 508 DG L 508 DG Kastenw.			01.82 01.75 01.68 01.77	12.75		03.3222-5804.3 03.3222-7802.3	020083 020088		Rz 22,20 Rz 22,20		
	L 405 D L 406 DG L 407 D L 408 DG L 408 G L 409 L 410 L 508 D L 508 DG L 508 DG Kastenw.			01.72 01.67 01.75 01.68 01.67 01.75 01.82 01.75 01.68 01.77	12.80 12.75 12.75 12.75 12.75 12.82 12.75 12.75 12.75		83.6103-0450.3	330228	2	L=450		
	L 405 D L 406 DG L 407 D L 408 DG L 408 G L 409 L 410 L 508 D L 508 DG L 508 DG Kastenw.	018261 018261 001330		01.75 01.68 01.75 01.82 01.75 01.68 01.77	12.80 12.75 12.75 12.82 12.75 12.75 12.75		03.3222-5804.3 03.3222-7802.3	020083 020088		Rz 22,20 Rz 22,20		
	L 405 D L 406 DG L 408 DG L 408 G L 508 DG L 405 D L 406 DG L 407 D L 408 DG L 408 G L 409 L 410 L 508 D L 508 DG		285631 285631 285631 285631 285631	01.72 01.67 01.68 01.67 01.68			24.2419-0937.3 03.0350-1926.2	030063 071926		+ ATE-Zylinder ²⁾	Gz 19,05 Gz Reparatursatz	FTE ATE
	L 405 D L 406 DG L 407 D L 408 DG L 408 G L 409 L 410 L 508 D L 508 DG	285632 285632 285632 285632		01.72 01.67 01.75 01.68 01.67 01.75 01.82 01.75 01.68	12.80 12.75 12.75 12.75 12.82 12.75 12.75		24.2419-0901.3	030041			Gz 19,05	
	L 405 D L 406 DG L 407 D L 408 G L 409 L 410 L 408 DG L 508 D L 508 DG			01.72 01.67 01.75 01.67 01.75 01.82 01.68 01.75 01.68	12.80 12.75 12.75 12.75 12.82 12.75 12.75		03.2523-0812.3 03.0450-2311.2	040020 082311			Nz 23,81 Nz Reparatursatz	
	L 408 DG L 508 D L 508 DG			01.68 01.75 01.68	12.75 12.75 12.75		03.0450-2805.2	082805			Nz Reparatursatz	

MERCEDES BENZ Transporter (BM 310) L508 D/L608 D

	LF 508 D LF 608 D		530029 530029	01.78 01.82			03.2122-4902.3 03.0370-3922.2	010144 053922		THz 22,20 THz Reparatursatz	ATE
	LF 508 D LF 608 D	530030 530030					03.2125-1302.3	010203		THz 25,40	ATE
	L 608 D	162734	530029		5,6 t		03.2122-4902.3 03.0370-3922.2	010144 053922		THz 22,20 THz Reparatursatz	ATE
	L 608 D	530030			5,6 t		03.2125-1302.3	010203		THz 25,40	ATE
	L 608 D	145736		01.72	6,5 t		03.2125-1102.3	010202		THz 25,40	ATE
	L 608 D	145737			6,5 t		03.2125-1302.3	010203		THz 25,40	ATE
	L 608 D		145736	01.72	6,5 t		03.3508-3600.3	310030		Behälter	
	L 608 D L 608 D L 608 D LF 508 D LF 608 D LT 608 D			01.68 01.72 01.79 01.78 01.82	5,6 t 6,5 t 6,7 t		83.6133-0500.3	330272	2	L=500	
	LF 508 D LF 608 D			01.78 01.82			03.3222-7802.3	020088		Rz 22,20	
	L 608 D			01.68	5,6 t ¹⁾ - VA 730.506/600 ³⁾		03.3222-5804.3	020083		Rz 22,20	
	L 608 D L 608 D L 608 D	145737		01.68 01.79	5,6 t ⁴⁾ + VA 730.506 6,5 t ⁵⁾ - VA 730.530/600 6,7 t ⁶⁾ - VA 730.600		24.3223-1705.3	020418		Rz 23,81	
	L 608 D L 608 D L 608 D LF 508 D LF 608 D			01.68 01.72 01.79 01.78 01.82	5,6 t 6,5 t 6,7 t		83.6103-0450.3	330228	2	L=450	
	LF 508 D LF 608 D			01.78 01.82			03.3222-7802.3	020088		Rz 22,20	
	L 608 D			01.68	5,6 t ⁷⁾ - HA 741.334/335		03.3222-5804.3	020083		Rz 22,20	
	L 608 D			01.68	5,6 t ⁸⁾ + HA 741.334/335		24.3238-0901.3	020298		Rz 38,10	
	L 608 D	145737			6,5 t ⁹⁾ - HA 741.201		24.3223-1705.3	020418		Rz 23,81	

¹⁾ BM 309.429/wheel base 4100mm / BM 309.429/passo 4100mm / BM 309.429/empattem. 4100mm / BM 309.429/dist.lejes 4100mm

²⁾ + ATE cylinder / + ATE - frizione idraulica / + cylindre ATE / + cilíndrico de ATE

³⁾ 5,6 t¹⁾ - FA 730.506/600 / 5,6 t¹⁾ - A 730.506/600 / 5,6 t¹⁾ - ess. AV 730.506/600 / 5,6 t¹⁾ - ED 730.506/600

⁴⁾ 5,6 t¹⁾ + FA 730.506 / 5,6 t¹⁾ + A 730.506 / 5,6 t¹⁾ + ess. AV 730.506 / 5,6 t¹⁾ + ED 730.506

⁵⁾ 6,5 t¹⁾ - FA 730.530/600 / 6,5 t¹⁾ - A 730.530/600 / 6,5 t¹⁾ - ess. AV 730.530/600 / 6,5 t¹⁾ - ED 730.530/600





















⁶⁾ 6,7 t¹⁾ - FA 730.600 / 6,7 t¹⁾ - A 730.600 / 6,7 t¹⁾ - ess. AV 730.600 / 6,7 t¹⁾ - ED 730.600

⁷⁾ 5,6 t¹⁾ - RA 741.334/335 / 5,6 t¹⁾ - P 741.334/335 / 5,6 t¹⁾ - ess. AR 741.334/335 / 5,6 t¹⁾ - ET 741.334/335

⁸⁾ 5,6 t¹⁾ + RA 741.334/335 / 5,6 t¹⁾ + P 741.334/335 / 5,6 t¹⁾ + ess. AR 741.334/335 / 5,6 t¹⁾ + ET 741.334/335

⁹⁾ 6,5 t¹⁾ - RA 741.201 / 6,5 t¹⁾ - P 741.201 / 6,5 t¹⁾ - ess. AR 741.201 / 6,5 t¹⁾ - ET 741.201



MERCEDES BENZ Transporter (BM 310) L508 D/L608 D												
	L 608 D L 608 D	145737		01.79	6,5 V - HA 741.300/335 ¹⁾ 6,7 V - HA 741.335 ²⁾	24.3223-1705.3	020418			Rz 23,81		
	L 608 D L 608 D	145737		01.79	6,5 V + HA 741.335 ³⁾ 6,7 V + HA 741.335 ⁴⁾	24.3238-0901.3	020298			Rz 38,10		
	L 608 D L 608 D		285631	01.68	5,6 t	24.2419-0937.3	030063			Gz 19,05	FTE	
	L 608 D L 608 D		285631	01.72	6,5 t	03.0350-1926.2	071926		+ ATE-Zylinder ⁵⁾	Gz Reparatursatz	ATE	
	L 608 D L 608 D LF 608 D LF 608 D LT 608 D	285632 285632		01.79 01.78 01.82	5,6 t 6,5 t 6,7 t	24.2419-0901.3	030041			Gz 19,05		
	L 608 D L 608 D L 608 D LF 508 D LF 608 D LT 608 D			01.68 01.72 01.79 01.78 01.82	5,6 t 6,5 t 6,7 t	03.0450-2805.2	082805			Nz Reparatursatz		
					BM 310.100							
MERCEDES BENZ Transporter (BM 313) L613 D/L614 D												
	L 613 D L 614 D		352290 352290	01.77 01.77	- 6,8 t	03.2125-1302.3	010203			Thz 25,40	ATE	
	L 613 D L 614 D			01.77 01.77	- 6,8 t	83.6133-0500.3	330272	2		L=500		
	L 613 D			01.80	+ 6,8 t	83.6133-0551.3	330273	2		L=550		
	L 613 D L 614 D			01.77 01.77	- 6,8 t	24.3223-1705.3	020418			Rz 23,81		
	L 613 D			01.80	+ 6,8 t	24.3238-0901.3	020298		- Druckbolzen ⁶⁾	Rz 38,10		
	L 613 D L 614 D			01.77 01.77		83.6103-0450.3	330228	2		L=450		
	L 613 D L 614 D			01.77 01.77	- 6,8 t	24.3223-1705.3	020418			Rz 23,81		
	L 613 D			01.80	+ 6,8 t	24.3238-0901.3	020298		- Druckbolzen ⁶⁾	Rz 38,10		
	L 613 D L 614 D			01.77 01.77		24.2419-0901.3	030041			Gz 19,05		
	L 613 D L 614 D			01.77 01.77		03.0450-2805.2	082805			Nz Reparatursatz		
MERCEDES BENZ Transporter L319/L405-L408												
	L 319 B/D L 405/406/407/408			01.55 01.55	12.67 12.67		83.6103-0450.3	330228	2	L=450		
	L 319 B/D L 405/406/407/408			01.55 01.55	12.67 12.67		83.6103-0450.3	330228	2	L=450		
MERCEDES BENZ Transporter 311/312												
	311 L/LA/LP/LAP 312 L/LA 312/36 LA			01.55 01.55 01.55	12.61 12.61 12.61	+ 1-Kammer-Druckluftbremse ⁷⁾ + 1-Kammer-Druckluftbremse ⁷⁾	03.0370-1131.2 03.0370-1038.2 03.0370-9998.2	051131 051038 059998		Hz Reparatursatz Hz Rep. Satz, -Kolben	ATE	
	311 L/LA/LP/LAP 312 L/LA			01.55 01.55	12.61 12.61		03.3508-0501.3	310017	0,35 l	Behälter		
	311 L/LA/LP/LAP 312 L/LA			01.55 01.55	12.61 12.61		83.6103-0450.3	330228	2	L=450		
	311 L/LA/LP/LAP 312 L/LA			01.55 01.55	12.61 12.61		83.6103-0500.3	330230	2	L=500		
MERCEDES BENZ MB-TRAC (BM 440) 65/70/700/800/900												
	MB-Trac 65/70 MB-Trac 700		011581	01.73 01.76	12.76		03.2320-0201.3	010234		Einlaß mit Gummistopfen ⁸⁾	Hz 28,57/20,64	ATE
	MB-Trac 65/70 MB-Trac 700		011581	01.73 01.76	12.76		03.3508-0401.3	310014		Aufschraubbehälter ⁹⁾	Behälter	
	MB-Trac 800 MB-Trac 900			01.75 01.81			13.2601-8037.2 13.2601-8038.2 13.0441-6012.2 13.0441-6001.2 13.0441-6010.2 03.3518-6100.2 03.3518-8000.2	210169 210170 250133 250126 250132 390364 390373	 	+ Vorgänger/ + Abschirmkappe ¹⁰⁾ + Vorgänger/ - Abschirmkappe ¹¹⁾	D=60 D=60 Dichtungssatz Dichtungssatz Dichtungssatz Entlüfterventil Entlüfterventil	ATE ATE ATE ATE
	MB-Trac 800 MB-Trac 900			01.75 01.81			13.0460-6031.2 24.8190-0403.2	606031 620403	2		29581 15,0 /WE Warnkontakt L=315mm	ATE

¹⁾ 6,5 V - RA 741.300/335 / 6,5 V - P 741.300/335 / 6,5 V - ess. AR 741.300/335 / 6,5 V - ET 741.300/335

²⁾ 6,7 V - RA 741.335 / 6,7 V - P 741.335 / 6,7 V - ess. AR 741.335 / 6,7 V - ET 741.335

³⁾ 6,5 V + RA 741.335 / 6,5 V + P 741.335 / 6,5 V + ess. AR 741.335 / 6,5 V + ET 741.335

⁴⁾ 6,7 V + RA 741.335 / 6,7 V + P 741.335 / 6,7 V + ess. AR 741.335 / 6,7 V + ET 741.335

⁵⁾ + ATE cylinder / + ATE - frizione idraulica / + cylindre ATE / + cilindrico de ATE

⁶⁾ - tappet / - punteria / - boulon de pression / - perno de presión



























⁷⁾ + single chamber air brake / + fr.pneum.a camera singola / + fr. pneumatique à 1 chambre / + freno de aire de 1 cámara

⁸⁾ inlet with rubber plug / mandata con tappo in gomma / admiss.avec bouch.caoutchouc / admission con tapón de goma

⁹⁾ screw on reservoir / serbatoio da avvitare / réservoir à visser / depósito de enroscamiento

¹⁰⁾ + predecessor/ + deflector cap / + preceden./+ calotta protez. / + prédecesseur/ + déflecteur / + predecesor/ + tapa deflector

¹¹⁾ + predecessor/ - deflector cap / + preceden./- calotta protez. / + prédecesseur/ - déflecteur / + predecesor/ - tapa deflector

MERCEDES BENZ MB-TRAC (BM 440) 65/70/700/800/900										
	MB-Trac 65/70 MB-Trac 700 MB-Trac 800 MB-Trac 900		01.73 01.76 01.75 01.81	12.76		24.5201-0220.3	331272		L=220	
	MB-Trac 800 MB-Trac 900		01.75 01.81			13.9544-0022.2 13.9544-0021.2 13.0441-5417.2 13.0471-5407.2 13.0471-5409.2 13.8158-0021.1 13.8158-0020.1 13.0471-5405.2 13.0471-5408.2	210258 210257 250118 250137 250139 990114 990113 250136 250138	 HA: 000192- 1)	D=54 D=54 Dichtungssatz Verbindungsschrauben Rep.Satz Bremshebel Handbremshebel Handbremshebel Rep.Satz Nachstellung Rep.Satz Rückstellwelle	ATE ATE ATE
	MB-Trac 800 MB-Trac 900		01.75 01.81			13.0460-6031.2 24.8190-0403.2	606031 620403	2	29581 15,0 /WE Warnkontakt L=315mm	ATE
	MB-Trac 65/70 MB-Trac 700 MB-Trac 800 MB-Trac 900		01.73 01.76 01.75 01.81	12.76		83.6203-0250.3	330299		L=250	
	MB-Trac 65/70 MB-Trac 700		01.73 01.76	12.76		03.3222-4007.3	020074		Rz 22,20	
	MB-Trac 700 MB-Trac 800 MB-Trac 900		01.76 01.75 01.81			24.2419-0934.3	030060		Gz 19,05	
MERCEDES BENZ MB-TRAC (BM 441) 1000										
	MB-Trac 1000		01.82			13.2601-8035.2 13.2601-8037.2 13.2601-8036.2 13.2601-8038.2 13.2601-7015.2 13.2601-7016.2 13.0441-6012.2 13.0441-6001.2 13.0441-6010.2 03.3518-6100.2 03.3518-8000.2	210167 210169 210168 210170 210230 210231 250133 250126 250132 390364 390373	 - aktive Lüftspieleinstellung 2)  - aktive Lüftspieleinstellung 2)  + aktive Lüftspieleinstellung 3)  + aktive Lüftspieleinstellung 3)	D=60 D=60 D=60 D=60 D=60 D=60 Dichtungssatz Dichtungssatz Dichtungssatz Entlüfterventil Entlüfterventil	ATE ATE ATE ATE ATE ATE ATE ATE
	MB-Trac 1000		01.82			13.0460-6031.2 13.0460-0214.2 24.8190-0403.2	606031 610214 620403	2 4	29581 15,0 /WE Belagsatz-Zubehör Warnkontakt L=315mm	ATE ATE
	MB-Trac 1000		01.82			13.9544-0022.2 13.9544-0021.2 13.0441-5417.2 13.0471-5407.2 13.0471-5409.2 13.8158-0020.1 13.8158-0021.1 13.0471-5405.2 13.0471-5408.2	210258 210257 250118 250137 250139 990114 990113 250136 250138	 HA: 000192- 1)	D=54 D=54 Dichtungssatz Verbindungsschrauben Rep.Satz Bremshebel Handbremshebel Handbremshebel Rep.Satz Nachstellung Rep.Satz Rückstellwelle	ATE ATE ATE ATE ATE ATE ATE ATE
	MB-Trac 1000		01.82			13.0460-6031.2 24.8190-0403.2	606031 620403	2	29581 15,0 /WE Warnkontakt L=315mm	ATE
MERCEDES BENZ MB-TRAC (BM 442/443) 1100/1300/1500										
	MB-Trac 1100 MB-Trac 1300 MB-Trac 1500		01.76 01.76 01.80			83.6203-0250.3	330299	am Hauptzylinder 6)	L=250	
	MB-Trac 1100 MB-Trac 1300	005702 005702	01.76 01.76			83.6203-0250.3 24.5201-0220.3 83.6103-0400.3	330299 331272 330226	am Hauptzylinder 6)	L=250 L=220 L=400	
	MB-Trac 1100 MB-Trac 1300 MB-Trac 1500	074200 074200 074200	01.76 01.76 01.80			24.5901-0517.3	330054		L=517	
MERCEDES BENZ UNIMOG (BM 403) 54/66/72/800										
	U 54 U 66 U 72 U 800		06.73 06.73 06.73 01.77	12.77 12.77 12.77		13.2601-8035.2 13.2601-8037.2 13.2601-8036.2 13.2601-8038.2 13.2601-7015.2 13.2601-7016.2 13.0441-6012.2 13.0441-6001.2 13.0441-6010.2 03.3518-6100.2 03.3518-8000.2	210167 210169 210168 210170 210230 210231 250133 250126 250132 390364 390373	 - aktive Lüftspieleinstellung 2)  - aktive Lüftspieleinstellung 2)  + aktive Lüftspieleinstellung 3)  + aktive Lüftspieleinstellung 3)	D=60 D=60 D=60 D=60 D=60 D=60 Dichtungssatz Dichtungssatz Dichtungssatz Entlüfterventil Entlüfterventil	ATE ATE ATE ATE ATE ATE ATE ATE
	U 54 U 66 U 72 U 800		06.73 06.73 06.73 01.77	12.77 12.77 12.77		13.0460-6031.2 13.0460-0214.2 24.8190-0403.2	606031 610214 620403	2 4	29581 15,0 /WE Belagsatz-Zubehör Warnkontakt L=315mm	ATE ATE
	U 54 U 66 U 72 U 800		01.64 01.64 01.64 01.77	12.77 12.77 12.77		24.5201-0220.3	331272		L=220	

1) RA: 000192- / P: 000192- / ess. AR: 000192- / ET: 000192-

2) - active clearance adjustment / - recupero autom. del gioco / - réglage act.d.jeu fonctionnel / - ajust.activ.jueg.ventilación



























3) + active clearance adjustment / + recuperato autom. del gioco / + réglage act.d.jeu fonctionnel / + ajust.activ.jueg.ventilación

4) + predecessor / + deflector cap / + preceden./+ calotta protez. / + prédecesseur/ + déflecteur / + predecesor/ + tapa deflector

5) + predecessor / - deflector cap / + preceden./- calotta protez. / + prédecesseur/ - déflecteur / + predecesor/ - tapa deflector

6) on the master cylinder / sulla pompa freno / sur le maître-cylindre / a la bomba principal de freno



												
MERCEDES BENZ UNIMOG (BM 403) 54/66/72/800												
	U 54 U 66 U 72 U 800			06.73 06.73 06.73 01.77	12.77 12.77 12.77 12.77	13.9544-0022.2 13.9544-0021.2 13.0441-5417.2 13.0471-5407.2 13.0471-5409.2 13.8158-0021.1 13.8158-0020.1 13.0471-5405.2 13.0471-5408.2	210258 210257 250118 250137 250139 990114 990113 250136 250138	HA: 030614- 1)	D=54 D=54 Dichtungssatz Verbindungsschrauben Rep.Satz Bremshebel Handbremshebel Handbremshebel Rep.Satz Nachstellung Rep.Satz Rückstellwelle	ATE ATE ATE		
	U 54 U 66 U 72 U 800			06.73 06.73 06.73 01.77	12.77 12.77 12.77 12.77	13.0460-6031.2 24.8190-0403.2	606031 620403	2	29581 15,0 /WE Warnkontakt L=315mm	ATE		
	U 54 U 66 U 72 U 800			01.64 01.64 01.64 01.77	12.77 12.77 12.77 12.77	+ Trommelbremse 2) + Trommelbremse 2) + Trommelbremse 2) + Trommelbremse 2)	83.6203-0300.3 83.6192-0250.3	330386 330726	L=300 L=250			
	U 54 U 66 U 72 U 800			06.73 06.73 06.73 01.77	12.77 12.77 12.77 12.77	+ Scheibenbremse 3) + Scheibenbremse 3) + Scheibenbremse 3) + Scheibenbremse 3)	83.6203-0300.3 83.6203-0250.3	330386 330299	L=300 L=250			
	U 54 U 66 U 72		001945 001945 001945	01.64 01.64 01.64				03.3220-0905.3 020059	Rz 20,64			
	U 54 U 66 U 72 U 800	001946 001946 001946			12.77 12.77 12.77 12.77			03.3222-4007.3 020074	Rz 22,20			
	U 54 U 66 U 72 U 800			01.64 01.64 01.64 01.77	12.77 12.77 12.77 12.77			24.2419-0934.3 030060	Gz 19,05			
	U 54 U 66 U 72 U 800			01.64 01.64 01.64 01.77	12.77 12.77 12.77 12.77			83.6103-0240.3 330220	L=240			
MERCEDES BENZ UNIMOG (BM 404) 82/110/404 S												
	U 110 U 404 S U 82			01.71 01.55 01.71	12.77 12.70 12.77			24.7718-7301.2 990024	Rückschlagventil			
	U 404 S			01.55	12.65	- BM 404.117		03.3508-3600.3 310030	Behälter			
	U 404 S U 110 U 404 S U 82			01.55 01.71 01.65 01.71	12.65 12.77 12.70 12.77	- BM 404.117		83.6103-0400.3 83.6203-0300.3 83.6103-0400.3	330226 330386 330226	am Hauptzylinder 4)		
	U 110 U 404 S U 82			01.71 01.55 01.71	12.77 12.70 12.77			83.6203-0250.3 83.6192-0250.3	330299 330726	L=250 L=250		
	U 110 U 404 S U 82			01.71 01.55 01.71	12.77 12.70 12.77			03.3228-0502.3 020109	Rz 28,57			
	U 110 U 404 S U 82			01.71 01.65 01.71	12.77 12.70 12.77			24.2419-0934.3 030060	Gz 19,05			
	U 404 S U 110 U 82			01.65 01.71 01.71	12.70 12.77 12.77			83.6103-0240.3 83.6203-0300.3 83.6203-0300.3	330220 330386 330386	L=240 L=300 L=300		
MERCEDES BENZ UNIMOG (BM 406) 65/70/80/84/900												
	U 65 U 70 U 80 U 84		005735 005735 005735 005735	01.64 01.64 01.64 01.64		+ Trommelbremse 2) + Trommelbremse 2) + Trommelbremse 2) + Trommelbremse 2)		03.3508-0801.3 310023	Behälter			
	U 65 U 70 U 80 U 84 U 900			06.73 06.73 06.73 06.73 06.73	12.77 12.77 12.77 12.77 12.77			13.2601-8035.2 13.2601-8037.2 13.2601-8036.2 13.2601-8038.2 13.2601-7015.2 13.2601-7016.2 13.0441-6012.2 13.0441-6001.2 13.0441-6010.2 03.3518-6100.2 03.3518-8000.2	210167 210169 210168 210170 210230 210231 250133 250126 250132 390364 390373	- aktive Lüftspieleinstellung 5) - aktive Lüftspieleinstellung 5) + aktive Lüftspieleinstellung 6) + aktive Lüftspieleinstellung 6) + Vorgänger/ + Abschirmkappe 7) + Vorgänger/ - Abschirmkappe 8) L= 52 mm L= 90 mm	D=60 D=60 D=60 D=60 D=60 D=60 Dichtungssatz Dichtungssatz Dichtungssatz Entlüfterventil Entlüfterventil	ATE ATE ATE ATE ATE ATE ATE ATE
	U 65 U 70 U 80 U 84 U 900			06.73 06.73 06.73 06.73 06.73	12.77 12.77 12.77 12.77 12.77			13.0460-6031.2 13.0460-0214.2 24.8190-0403.2	606031 610214 620403	2 4	29581 15,0 /WE Belagsatz-Zubehör Warnkontakt L=315mm	ATE ATE

1) RA: 030614- / P: 030614- / ess. AR: 030614- / ET: 030614-

2) + drum brake / + freno a tamburo / + freins à tambour / + tambores de freno

3) + disc brake / + disco freno / + disques de frein / + disco de freno

4) on the master cylinder / sulla pompa freno / sur le maître-cylindre / a la bomba principal de freno

5) - active clearance adjustment / - recupero autom. del gioco / - réglage act.d.jeu fonctionnel / - ajust.act.ív.jueg.ventilación

6) + active clearance adjustment / + recupero autom. del juego / + réglage act.d.jeu fonctionnel / + ajust.act.ív.jueg.ventilación

7) + predecessor/ + deflector cap / + preceden./+ calotta protez. / + prédecesseur/ + déflecteur / + predecesor/ + tapa deflector

8) + predecessor/ - deflector cap / + preceden./- calotta protez. / + prédecesseur/ - déflecteur / + predecesor/ - tapa deflector

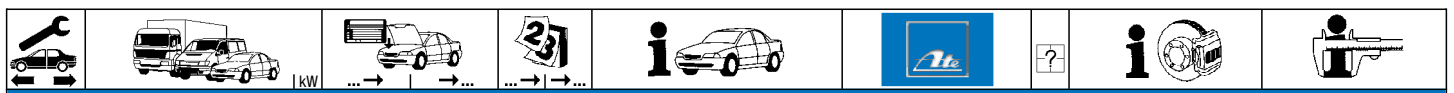

MERCEDES BENZ UNIMOG (BM 406) 65/70/80/84/900

	U 65		005735	01.64		83.6203-0300.3	330386	am Hauptzylinder ¹⁾ + Triebkopf ²⁾	L=300	ATE
	U 70		005735	01.64		24.5201-0220.3	331272		L=220	
	U 80		005735	01.64		83.6103-0400.3	330226		L=400	
	U 84		005735	01.64						
	U 900		005735	01.64						
	U 65	005736			12.77	24.5201-0220.3	331272	+ Triebkopf ²⁾	L=220	ATE
	U 70	005736			12.77	83.6103-0400.3	330226		L=400	
	U 80	005736			12.77					
	U 84	005736			12.77					
	U 900	013570			12.77					
	U 65			06.73	12.77	13.9544-0022.2	210258	HA: 030614- ³⁾	D=54	ATE ATE
	U 70			06.73	12.77	13.9544-0021.2	210257		Dichtungssatz	
	U 80			06.73	12.77	13.0441-5417.2	250118		Verbindungsschrauben	
	U 84			06.73	12.77	13.0471-5407.2	250137		Rep.Satz Bremshebel	
	U 900			06.73	12.77	13.0471-5409.2	250139		Handbremshebel	
	U 65			06.73	12.77	13.8158-0021.1	990114	2	29581 15,0 /WE	ATE
	U 70			06.73	12.77	13.0471-5405.2	250136		Rep.Satz Nachstellung	
	U 80			06.73	12.77	13.0471-5408.2	250138		Rep.Satz Rückstellwelle	
	U 84			06.73	12.77					
	U 900			06.73	12.77					
	U 65			01.64		83.6203-0300.3	330386	+ Trommelbremse ⁴⁾	L=300	ATE
	U 70			01.64		83.6192-0250.3	330726		L=250	
	U 80			01.64						
	U 84			01.64						
	U 900	013570								
	U 65			06.73	12.77	83.6203-0300.3	330386	+ Scheibenbremse ⁵⁾	L=300	ATE
	U 70			06.73	12.77	83.6192-0250.3	330726		L=250	
	U 80			06.73	12.77					
	U 84			06.73	12.77					
	U 900			06.73	12.77					
	U 65		013569	01.64		03.3220-0905.3	020059		Rz 20,64	
	U 70		013569	01.64						
	U 80		013569	01.64						
	U 84		013569	01.64						
	U 900	013570				03.3222-4007.3	020074		Rz 22,20	
	U 65	005736			12.77	24.2419-0934.3	030060		Gz 19,05	
	U 70	005736			12.77					
	U 80	005736			12.77					
	U 84	005736			12.77					
	U 900	005736			12.77					
	U 65		005735	01.64		83.6203-0200.3	330298		L=200	
	U 70		005735	01.64						
	U 80		005735	01.64						
	U 84		005735	01.64						
	U 900	005736			12.77	83.6103-0240.3	330220		L=240	

MERCEDES BENZ UNIMOG (BM 407) 600/650/650 L

	600			01.88		24.2419-0934.3	030060		Gz 19,05	
	650			01.88						
	650 L			01.88						

MERCEDES BENZ UNIMOG (BM 411) 411

	U 411	22		01.56	12.65	03.3125-0401.3	010290		Hz 25,40	ATE
	U 411	23		01.56	12.65					
	U 411 A	22		01.56	12.65					
	U 411 A	23		01.56	12.65					
	U 411			01.56	12.65	03.3508-3600.3	310030		Behälter	
	U 411 A			01.56	12.74					
	U 411 A	25	029950		12.74	24.5201-0220.3	331272		L=220	
	U 411			01.56	12.65	24.5201-0220.3	331272			
	U 411 A			01.56	12.74	83.6103-0190.3	330218	+ Triebkopf ²⁾	L=220	
	U 411			01.56	12.65				L=190	
	U 411	22		01.56	12.65	03.3222-0902.3	020068		Rz 22,20	
	U 411	23		01.56	12.65					
	U 411 A	22		01.56	12.65					
	U 411 A	23		01.56	12.65					
	U 411 A	25			01.65	12.74	03.3222-4007.3		020074	

¹⁾ on the master cylinder / sulla pompa freno / sur le maître-cylindre / a la bomba principal de freno

²⁾ + drive head / + motrice con sola cabina / + tête de propulsion / + grupo motriz

³⁾ RA: 030614- / P: 030614- / ess. AR: 030614- / ET: 030614-

⁴⁾ + drum brake / + freno a tamburo / + freins à tambour / + tambores de freno

⁵⁾ + disc brake / + disco freno / + disques de frein / + disco de freno

MERCEDES BENZ UNIMOG (BM 413) 72/80/800 L													
	U 72 U 80 U 800 L			06.73 06.73 01.77	12.77 12.77	13.2601-8035.2 13.2601-8037.2 13.2601-8036.2 13.2601-8038.2 13.2601-7015.2 13.2601-7016.2 13.0441-6012.2 13.0441-6001.2 13.0441-6010.2 03.3518-6100.2 03.3518-8000.2	210167 210169 210168 210170 210230 210231 250133 250126 250132 390364 390373	<input type="checkbox"/> - aktive Lüftspieleinstellung 1) <input type="checkbox"/> - aktive Lüftspieleinstellung 1) <input type="checkbox"/> + aktive Lüftspieleinstellung 2) <input type="checkbox"/> + aktive Lüftspieleinstellung 2) <input type="checkbox"/> + Vorgänger/ + Abschirmkappe 3) <input type="checkbox"/> + Vorgänger/ - Abschirmkappe 4)	D=60 D=60 D=60 D=60 D=60 D=60 Dichtungssatz Dichtungssatz Dichtungssatz Entlüfterventil Entlüfterventil	ATE ATE ATE ATE ATE ATE ATE ATE			
	U 72 U 80 U 800 L			06.73 06.73 01.77	12.77 12.77	13.0460-6031.2 13.0460-0214.2 24.8190-0403.2	606031 610214 620403	2 4		29581 15,0 /WE Belagsatz-Zubehör Warnkontakt L=315mm	ATE ATE		
	U 72 U 80 U 800 L			01.73 01.73 01.77	12.77 12.77	24.5201-0220.3	331272			L=220			
	U 72 U 80 U 800 L			06.73 06.73 01.77	12.77 12.77	13.9544-0022.2 13.9544-0021.2 13.0441-5417.2 13.0471-5407.2 13.0471-5409.2 13.8158-0021.1 13.8158-0020.1 13.0471-5405.2 13.0471-5408.2	210258 210257 250118 250137 250139 990114 990113 250136 250138	<input type="checkbox"/> HA: 017945- 5)	D=54 D=54 Dichtungssatz Verbindungsschrauben Rep.Satz Bremshebel Handbremshebel Handbremshebel Rep.Satz Nachstellung Rep.Satz Rückstellwelle	ATE ATE ATE			
	U 72 U 80 U 800 L			06.73 06.73 01.77	12.77 12.77	13.0460-6031.2 24.8190-0403.2	606031 620403	2		29581 15,0 /WE Warnkontakt L=315mm	ATE		
	U 72 U 80 U 800 L			01.73 01.73 01.77	12.77 12.77 12.77	83.6203-0300.3 83.6192-0250.3	330386 330726	<input type="checkbox"/>		L=300 L=250			
	U 72 U 80 U 800 L			06.73 06.73 01.77	12.77 12.77 12.77	83.6203-0300.3 83.6192-0250.3	330386 330726	<input type="checkbox"/>		L=300 L=250			
	U 72 U 80 U 800 L			01.73 01.73 01.77	12.77 12.77	24.2419-0934.3	030060			Gz 19,05			
	U 72 U 80 U 800 L			01.73 01.73 01.77	12.77 12.77	83.6103-0240.3	330220			L=240			

MERCEDES BENZ UNIMOG (BM 416) 80/90/100/110/1100/1100 L												
	U 80 U 90			000078 000078	01.64 01.64	03.3508-0801.3	310023			Behälter		
	U 100 U 110 U 1100 U 1100 L U 125 U 80 U 90			06.73 06.73 01.77 01.77 06.73 06.73 06.73	12.77 12.77 12.77 12.77 12.77 12.77 12.77	13.2601-8035.2 13.2601-8037.2 13.2601-8036.2 13.2601-8038.2 13.2601-7015.2 13.2601-7016.2 13.0441-6012.2 13.0441-6001.2 13.0441-6010.2 03.3518-6100.2 03.3518-8000.2	210167 210169 210168 210170 210230 210231 250133 250126 250132 390364 390373	<input type="checkbox"/> - aktive Lüftspieleinstellung 1) <input type="checkbox"/> - aktive Lüftspieleinstellung 1) <input type="checkbox"/> + aktive Lüftspieleinstellung 2) <input type="checkbox"/> + aktive Lüftspieleinstellung 2) <input type="checkbox"/> + Vorgänger/ + Abschirmkappe 3) <input type="checkbox"/> + Vorgänger/ - Abschirmkappe 4)	D=60 D=60 D=60 D=60 D=60 D=60 Dichtungssatz Dichtungssatz Dichtungssatz Entlüfterventil Entlüfterventil	ATE ATE ATE ATE ATE ATE ATE ATE		
	U 100 U 110 U 1100 U 1100 L U 125 U 80 U 90			06.73 06.73 01.77 01.77 06.73 06.73 06.73	12.77 12.77 12.77 12.77 12.77 12.77 12.77	13.0460-6031.2 13.0460-0214.2 24.8190-0403.2	606031 610214 620403	2 4		29581 15,0 /WE Belagsatz-Zubehör Warnkontakt L=315mm	ATE ATE	
	U 80 U 90			000078 000078	01.64 01.64	83.6203-0300.3 24.5201-0220.3	330386 331272	<input type="checkbox"/> am Hauptzylinder 8)		L=300 L=220		
	U 100 U 110 U 1100 U 1100 L U 125 U 80 U 90	000079 000079 000079 000079		01.77 01.77 06.73 06.73 06.73	12.77 12.77 12.77 12.77 12.77	24.5201-0220.3 83.6192-0250.3	331272 330726	<input type="checkbox"/> + Triebkopf 9)		L=220 L=250		
	U 100 U 110 U 1100 U 1100 L U 125 U 80 U 90			06.73 06.73 01.77 01.77 06.73 06.73 06.73	12.77 12.77 12.77 12.77 12.77 12.77 12.77	13.9544-0022.2 13.9544-0021.2 13.0441-5417.2 13.0471-5407.2 13.0471-5409.2 13.8158-0021.1 13.8158-0020.1 13.0471-5405.2 13.0471-5408.2	210258 210257 250118 250137 250139 990114 990113 250136 250138	<input type="checkbox"/> HA: 017945- 5)	D=54 D=54 Dichtungssatz Verbindungsschrauben Rep.Satz Bremshebel Handbremshebel Handbremshebel Rep.Satz Nachstellung Rep.Satz Rückstellwelle	ATE ATE ATE		
	U 100 U 110 U 1100 U 1100 L U 125 U 80			06.73 06.73 01.77 01.77 06.73 06.73	12.77 12.77 12.77 12.77 12.77 12.77	13.0460-6031.2 24.8190-0403.2	606031 620403	2		29581 15,0 /WE Warnkontakt L=315mm	ATE	

1) - active clearance adjustment / - recupero autom. del gioco / - réglage act.d.jeu fonctionnel / - ajust.act.v.jueg. ventilación
2) + active clearance adjustment / + recupero autom. del gioco / + réglage act.d.jeu fonctionnel / + ajust.act.v.jueg. ventilación
3) + predecessor/ + deflector cap / + preceden./+ calotta protez. / + prédecresseur/ + déflecteur / + predecisor/ + tapa deflector
4) + predecessor/ - deflector cap / + preceden./- calotta protez. / + prédecresseur/ - déflecteur / + predecisor/ - tapa deflector

5) RA: 017945- / P: 017945- / ess. AR: 017945- / ET: 017945-
6) + drum brake / + freno a tamburo / + freins à tambour / + tambores de freno
7) + disc brake / + disco freno / + disques de frein / + disco de freno
8) on the master cylinder / sulla pompa freno / sur le maître-cylindre / a la bomba principal de freno
9) + drive head / + motrice con sola cabina / + tête de propulsion / + grupo motriz

MERCEDES BENZ UNIMOG (BM 416) 80/90/100/110/1100/1100 L													
	U 90			06.73	12.77		13.0460-6031.2	606031		2		29581 15,0 /WE	ATE
							24.8190-0403.2	620403				Warnkontakt L=315mm	
	U 80		000078	01.64			83.6103-0190.3	330218				L=190	
	U 90		000078	01.64			83.6203-0300.3	330386		■		L=300	
	U 100	000079			12.77		83.6203-0300.3	330386				L=300	
	U 110	000079			12.77		83.6192-0250.3	330726		■		L=250	
	U 1100 L			01.77									
	U 1100 L			01.77									
	U 125			06.73	12.77								
	U 80	000079			12.77								
	U 90	000079			12.77								
	U 100	000079	007388				03.3220-0905.3	020059				Rz 20,64	
	U 110	000079	007388										
	U 80		007388	01.64									
	U 90		007388	01.64									
	U 100	007389			12.77		03.3222-4007.3	020074				Rz 22,20	
	U 110	007389			12.77								
	U 1100 L			01.77									
	U 1100 L			01.77									
	U 80	007389			12.77								
	U 90	007389			12.77								
	U 100	000079			12.77		24.2419-0934.3	030060				Gz 19,05	
	U 110	000079			12.77								
	U 1100 L			01.77									
	U 1100 L			01.77									
	U 125	000079			12.77								
	U 80	000079			12.77								
	U 90	000079			12.77								
	U 80		000078	01.64			83.6203-0200.3	330298				L=200	
	U 90		000078	01.64									
	U 100	000079			12.77		83.6103-0240.3	330220				L=240	
	U 110	000079			12.77								
	U 1100 L			01.77									
	U 1100 L			01.77									
	U 125	000079			12.77								
	U 80	000079			12.77								
	U 90	000079			12.77								
MERCEDES BENZ UNIMOG (BM 417) 800-1150													
	U 1100						13.2601-8035.2	210167		■	- aktive Lüftspieleinstellung ¹⁾	D=60	ATE
	U 1150						13.2601-8037.2	210169		■	- aktive Lüftspieleinstellung ¹⁾	D=60	ATE
	U 800						13.2601-8036.2	210168		■	- aktive Lüftspieleinstellung ¹⁾	D=60	ATE
	U 900						13.2601-8038.2	210170		■	- aktive Lüftspieleinstellung ¹⁾	D=60	ATE
							13.2601-7015.2	210230		■	+ aktive Lüftspieleinstellung ²⁾	D=60	ATE
							13.2601-7016.2	210231		■	+ aktive Lüftspieleinstellung ²⁾	D=60	ATE
							13.0441-6012.2	250133				Dichtungssatz	
							03.3518-6100.2	390364				Entlüfterventil	
							03.3518-8000.2	390373				Entlüfterventil	
											L= 52 mm		
											L= 90 mm		
	U 1100						13.0460-6031.2	606031		2		29581 15,0 /WE	ATE
	U 1150						13.0460-0214.2	610214				Belagsatz-Zubehör	ATE
	U 800						24.8190-0403.2	620403		4		Warnkontakt L=315mm	
	U 900												
	U 1100						13.9544-0022.2	210258		■		D=54	ATE
	U 1150						13.9544-0021.2	210257		■		D=54	ATE
	U 800						13.0441-5417.2	250118				Dichtungssatz	ATE
	U 900						13.0471-5407.2	250137				Verbindungsschrauben	
							13.0471-5409.2	250139				Rep.Satz Bremshebel	
							13.8158-0021.1	990114		■		Handbremshebel	
							13.8158-0020.1	990113		■		Handbremshebel	
							13.0471-5405.2	250136				Rep.Satz Nachstellung	
							13.0471-5408.2	250138				Rep.Satz Rückstellwelle	
	U 1100						13.0460-6031.2	606031		2		29581 15,0 /WE	ATE
	U 1150						24.8190-0403.2	620403				Warnkontakt L=315mm	
	U 800												
	U 900												
MERCEDES BENZ UNIMOG (BM 421) 40/45/52/60/600/600 L													
	U 40			01.66	12.77		03.2320-0201.3	010234				Hz 28,57/20,64	ATE
	U 45			01.66	12.77								
	U 52			01.66	12.77								
	U 60			01.66	12.77								
	U 600			01.77									
	U 600 L			01.77									
	U 40			01.66	12.77		83.6203-0250.3	330299			am Hauptzylinder ³⁾	L=250	
	U 45			01.66	12.77		24.5201-0220.3	331272				L=220	
	U 52			01.66	12.77		83.6203-0300.3	330386		■		L=300	
	U 60			01.66	12.77								
	U 600			01.77									
	U 600 L			01.77									
	U 40			01.66	12.77		24.5201-0220.3	331272				L=220	
	U 45			01.66	12.77								
	U 52			01.66	12.77								
	U 60			01.66	12.77								
	U 600			01.77									
	U 600 L			01.77									

1) - active clearance adjustment / - recupero autom. del gioco / - réglage act.d.jeu fonctionnel / - ajust.activ.jueg.ventilación
2) + active clearance adjustment / + recupero autom. del gioco / + réglage act.d.jeu fonctionnel / + ajust.activ.jueg.ventilación
3) on the master cylinder / sulla pompa freno / sur le maître-cylindre / a la bomba principal de freno



MERCEDES BENZ UNIMOG (BM 421) 40/45/52/60/600/600 L					
U 40 U 45 U 52 U 60 U 600 U 600 L	01.66 12.77 01.66 12.77 01.66 12.77 01.66 12.77 01.77 01.77	03.3220-0905.3 020059		Rz 20,64	
U 40 U 45 U 52 U 60 U 600 U 600 L	01.66 12.77 01.66 12.77 01.66 12.77 01.66 12.77 01.77 01.77	24.2419-0934.3 030060		Gz 19,05	
U 40 U 45 U 52 U 60 U 600 U 600 L	01.66 12.77 01.66 12.77 01.66 12.77 01.66 12.77 01.77 01.77	83.6203-0250.3 330299 83.6103-0400.3 330226		L=250 L=400	
MERCEDES BENZ UNIMOG (BM 424) 1000/1200					
U 1000 U 1200	01.77 01.82	13.2601-8035.2 210167 13.2601-8037.2 210169 13.2601-8036.2 210168 13.2601-8038.2 210170 13.2601-7015.2 210230 13.2601-7016.2 210231 13.0441-6012.2 250133 13.0441-6001.2 250126 13.0441-6010.2 250132 03.3518-6100.2 390364 03.3518-8000.2 390373	- aktive Lüftspieleinstellung ¹⁾ - aktive Lüftspieleinstellung ¹⁾ + aktive Lüftspieleinstellung ²⁾ + aktive Lüftspieleinstellung ²⁾ + Vorgänger/ + Abschirmkappe ³⁾ + Vorgänger/ - Abschirmkappe ⁴⁾ L= 52 mm L= 90 mm	D=60 D=60 D=60 D=60 D=60 D=60 Dichtungssatz Dichtungssatz Dichtungssatz Entlüfterventil Entlüfterventil	ATE ATE ATE ATE ATE ATE ATE ATE
U 1000 U 1200	01.77 01.82	13.0460-6031.2 606031 13.0460-0214.2 610214 24.8190-0403.2 620403	2 4	29581 15,0 /WE Belagsatz-Zubehör Warnkontakt L=315mm	ATE ATE
U 1000 U 1200	01.77 01.82	24.5201-0220.3 331272 83.6203-0300.3 330386	<input type="checkbox"/>	L=220 L=300	
U 1000 U 1200	01.77 01.82	13.9544-0021.2 210257 13.9544-0022.2 210258 13.0441-5417.2 250118 13.0471-5407.2 250137 13.0471-5409.2 250139 13.8158-0020.1 990113 13.8158-0021.1 990114 13.0471-5405.2 250136 13.0471-5408.2 250138	<input type="checkbox"/> <input type="checkbox"/> <input type="checkbox"/> <input type="checkbox"/> <input type="checkbox"/> <input type="checkbox"/> <input type="checkbox"/> <input type="checkbox"/>	D=54 D=54 Dichtungssatz Verbindungsschrauben Rep.Satz Bremshebel Handbremshebel Handbremshebel Rep.Satz Nachstellung Rep.Satz Rückstellwelle	ATE ATE ATE ATE ATE ATE ATE
U 1000 U 1200	01.77 01.82	13.0460-6031.2 606031 24.8190-0403.2 620403	2	29581 15,0 /WE Warnkontakt L=315mm	ATE
U 1000 U 1200	01.77 01.82	VA:001925 VA:001925	83.6103-0240.3 330220	L=240	
MERCEDES BENZ UNIMOG (BM 425) 120/150/1300/1500					
U 120 U 1300 U 150 U 1500	01.74 12.77 01.77 01.74 12.77 01.77	03.3508-0503.3 310018		Behälter	
U 120 U 1300 U 150 U 1500	01.74 12.77 01.77 01.74 12.77 01.77	13.4571-8005.3 210205 13.4571-8006.3 210206 13.9571-0003.2 210277 13.9571-0004.2 210278 13.0441-5721.2 250123	2 <input type="checkbox"/> li. vor + re. hinter der Achse ⁵⁾ 2 <input type="checkbox"/> re. vor + li. hinter der Achse ⁶⁾ 2 <input type="checkbox"/> li. vor + re. hinter der Achse ⁵⁾ 2 <input type="checkbox"/> re. vor + li. hinter der Achse ⁶⁾	D=57/48 D=57/48 D=57/48 D=57/48 Dichtungssatz	ATE ATE ATE ATE ATE
U 120 U 1300 U 150 U 1500	01.74 12.77 01.77 01.74 12.77 01.77	24.5201-0220.3 331272 83.6203-0200.3 330298	<input type="checkbox"/>	L=220 L=200	
U 120 U 1300 U 150 U 1500	01.74 12.77 01.77 01.74 12.77 01.77	13.9574-7005.2 210275 13.9574-7006.2 210276 24.8190-0029.2 990156 24.8190-0030.2 990157 13.0441-5721.2 250123	<input type="checkbox"/> <input type="checkbox"/> <input type="checkbox"/> <input type="checkbox"/>	D=57/48 D=57/48 Handbremsbetätigung Handbremsbetätigung Dichtungssatz	ATE ATE ATE ATE ATE
U 120 U 1300 U 150 U 1500	01.74 12.77 01.77 01.74 12.77 01.77	83.6103-0300.3 330223		L=300	
MERCEDES BENZ UNIMOG (BM 426) 426					
U 426	01.66 12.77	24.5201-0220.3 331272		L=220	
U 426	01.66 12.77	83.6203-0300.3 330386 83.6192-0250.3 330726	<input type="checkbox"/>	L=300 L=250	
U 426	01.66 12.77	03.3220-0905.3 020059		Rz 20,64	

¹⁾ - active clearance adjustment / - recupero autom. del gioco / - réglage act.d.jeu fonctionnel / - ajust.activ.jueg.ventilación
²⁾ + active clearance adjustment / + recupero autom. del gioco / + réglage act.d.jeu fonctionnel / + ajust.activ.jueg.ventilación
³⁾ + predecessor/ + deflector cap / + preceden./+ calotta protez. / + prédecesseur/ + déflecteur / + predecesor/ + tapa deflector
⁴⁾ + predecessor/ - deflector cap / + preceden./- calotta protez. / + prédecesseur/ - déflecteur / + predecesor/ - tapa deflector
⁵⁾ left i.front + right beh.axle / sinist.d'avant.+ destr.diet.ass. / gauche dev. + droite derr.ess. / izqu.adel.+ derech.detrás eje
⁶⁾ right in front+left beh.axle / destr.d'avant.+sinist.diet.ass. / droite dev. + gauche derr.ess. / derech.adel.+ izqu.detrás eje



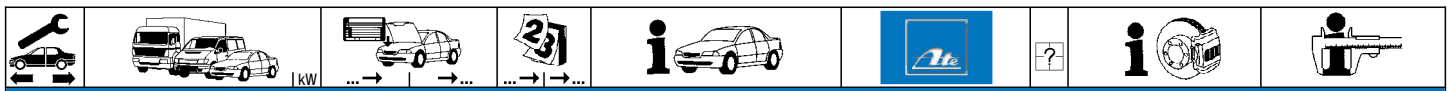

MERCEDES BENZ UNIMOG (BM 435) 435/1300 L/1700/1700 L

	U 1700			01.77		13.9574-7005.2	210275			D=57/48	ATE
	U 1700 L			01.77		13.9574-7006.2	210276			D=57/48	ATE
	U 435			01.74	12.77	24.8190-0029.2	990156			Handbremsbetätigung	ATE
						24.8190-0030.2	990157			Handbremsbetätigung	ATE
						13.0441-5721.2	250123			Dichtungssatz	ATE
	U 1300 L			01.78		13.9544-0021.2	210257			D=54	ATE
						13.9544-0022.2	210258			D=54	ATE
						13.0441-5417.2	250118			Dichtungssatz	ATE
						13.0471-5407.2	250137			Verbindungsschrauben	
						13.0471-5409.2	250139			Rep.Satz Bremshebel	
						13.8158-0020.1	990113			Handbremshebel	
						13.8158-0021.1	990114			Handbremshebel	
						13.0471-5405.2	250136			Rep.Satz Nachstellung	
						13.0471-5408.2	250138			Rep.Satz Rückstellwelle	
	U 1300 L			01.78		13.0460-6031.2	606031			29581 15,0 /WE	ATE
	U 1700			01.77		83.6103-0300.3	330223			L=300	
	U 1700 L			01.77							
	U 435			01.74	12.77						
	U 1300 L			01.77		83.6103-0240.3	330220			L=240	

MERCEDES BENZ UNIMOG (BM 436) 1300/1700

	U 1300					13.2601-8035.2	210167		- aktive Lüftspieleinstellung 1)	D=60	ATE	
						13.2601-8037.2	210169		- aktive Lüftspieleinstellung 1)	D=60	ATE	
						13.2601-8036.2	210168		- aktive Lüftspieleinstellung 1)	D=60	ATE	
						13.2601-8038.2	210170		- aktive Lüftspieleinstellung 1)	D=60	ATE	
						13.2601-7015.2	210230		+ aktive Lüftspieleinstellung 2)	D=60	ATE	
						13.2601-7016.2	210231		+ aktive Lüftspieleinstellung 2)	D=60	ATE	
						13.0441-6012.2	250133			Dichtungssatz		
						03.3518-6100.2	390364			Entlüfterventil		
				03.3518-8000.2	390373			Entlüfterventil				
	U 1700				ohne Entlüfterschraube 3)	13.9571-0003.2	210277		li. vor + li. hinter der Achse 4)	D=57/48	ATE	
					13.9571-0004.2	210278		re. vor + re. hinter der Achse 5)	D=57/48	ATE		
					13.0441-5721.2	250123			Dichtungssatz			
	U 1300					13.0460-6031.2	606031	2		29581 15,0 /WE	ATE	
						13.0460-0214.2	610214			Belagsatz-Zubehör	ATE	
						24.8190-0403.2	620403	4		Warnkontakt L=315mm		
	U 1300					13.9544-0022.2	210258			D=54	ATE	
						13.9544-0021.2	210257			D=54	ATE	
						13.0441-5417.2	250118			Dichtungssatz		
						13.0471-5407.2	250137			Verbindungsschrauben		
						13.0471-5409.2	250139			Rep.Satz Bremshebel		
						13.8158-0021.1	990114			Handbremshebel		
	U 1700					13.8158-0020.1	990113			Handbremshebel		
						13.0471-5405.2	250136			Rep.Satz Nachstellung		
						13.0471-5408.2	250138			Rep.Satz Rückstellwelle		
						13.9574-7005.2	210275			D=57/48	ATE	
						13.9574-7006.2	210276			D=57/48	ATE	
					24.8190-0029.2	990156			Handbremsbetätigung	ATE		
					24.8190-0030.2	990157			Handbremsbetätigung	ATE		
					13.0441-5721.2	250123			Dichtungssatz	ATE		
	U 1300					13.0460-6031.2	606031			29581 15,0 /WE	ATE	
						24.8190-0403.2	620403	2		Warnkontakt L=315mm		

MERCEDES BENZ UNIMOG (BM 437.1) 1350-2450

	U 1350 U 1550 L				- VA 737.361/362 6)	13.2601-8035.2	210167		- aktive Lüftspieleinstellung 1)	D=60	ATE
						13.2601-8037.2	210169		- aktive Lüftspieleinstellung 1)	D=60	ATE
						13.2601-8036.2	210168		- aktive Lüftspieleinstellung 1)	D=60	ATE
						13.2601-8038.2	210170		- aktive Lüftspieleinstellung 1)	D=60	ATE
						13.2601-7015.2	210230		+ aktive Lüftspieleinstellung 2)	D=60	ATE
						13.2601-7016.2	210231		+ aktive Lüftspieleinstellung 2)	D=60	ATE
						13.0441-6012.2	250133			Dichtungssatz	
						03.3518-6100.2	390364			Entlüfterventil	
				03.3518-8000.2	390373			Entlüfterventil			
	U 1550 L				+ VA 737.361/362 7)	13.2601-0145.2	210247		li. vor + re. hinter der Achse 8)	D=60	ATE
						13.2601-0146.2	210248		re. vor + li. hinter der Achse 9)	D=60	ATE
	U 1550 L/38				ohne Entlüfterschraube 3)	13.9571-0003.2	210277		li. vor + li. hinter der Achse 4)	D=57/48	ATE
	U 1700				ohne Entlüfterschraube 3)	13.9571-0004.2	210278		re. vor + re. hinter der Achse 5)	D=57/48	ATE
	U 1750				ohne Entlüfterschraube 3)	13.0441-5721.2	250123		Dichtungssatz		
	U 1800				ohne Entlüfterschraube 3)						
	U 1850				ohne Entlüfterschraube 3)						
	U 2100				ohne Entlüfterschraube 3)						
	U 2150				ohne Entlüfterschraube 3)						
	U 2400				ohne Entlüfterschraube 3)						
	U 2450				ohne Entlüfterschraube 3)						
	U 1350 U 1550 L				- VA 737.361/362 6)	13.0460-6031.2	606031	2		29581 15,0 /WE	ATE
						13.0460-0214.2	610214			Belagsatz-Zubehör	ATE
						24.8190-0403.2	620403	4		Warnkontakt L=315mm	

1) - active clearance adjustment / - recupero autom. del gioco / - réglage act.d.jeu fonctionnel / - ajust.activ.jueg. ventilación

2) + active clearance adjustment / + recupero autom. del gioco / + réglage act.d.jeu fonctionnel / + ajust.activ.jueg. ventilación

3) without bleed screw / senza vite di spurgo / sans vis de purge / sin tornillo de purga

4) left in front + left behind axle / davanti a sinistra+dietro a sinistra dell'assale / avant gauche + arrière gauche essieu / izquierda adelante+izquierda atrás eje

5) right in front + right behind axle / davanti a destra+dietro a destra dell'assale / avant droite + arrière droite essieu / derecha adelante+derecha atrás eje

6) - FA 737.361/362 / - A 737.361/362 / - ess. AV 737.361/362 / - ED 737.361/362

7) + FA 737.361/362 / + A 737.361/362 / + ess. AV 737.361/362 / + ED 737.361/362

8) left i.front + right beh.axle / sinist.davant.+destr.diet.ass. / gauche dev. + droite derr.ess. / izqu.adel.+ derech.detrás eje

9) right in front+left beh.axle / destr.davant.+sinist.diet.ass. / droite dev. + gauche derr.ess. / derech.adel.+ izqu.detrás eje



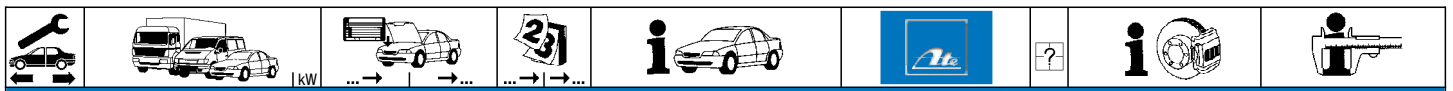

MERCEDES BENZ UNIMOG (BM 437.1) 1350-2450

















	U 1350 U 1550 L				- HA 747.362/364 ¹⁾	13.9544-0021.2 210257 13.9544-0022.2 210258 13.0441-5417.2 250118 13.0471-5407.2 250137 13.0471-5409.2 250139 13.8158-0020.1 990113 13.8158-0021.1 990114 13.0471-5405.2 250136 13.0471-5408.2 250138		D=54 D=54 Dichtungssatz Verbindungsschrauben Rep.Satz Bremshebel Handbremshebel Handbremshebel Rep.Satz Nachstellung Rep.Satz Rückstellwelle	ATE ATE ATE
	U 1550 L				+ HA 747.362/364 ²⁾	13.2544-0019.2 210251 13.2544-0020.2 210252	2 li. vor + re. hinter der Achse ³⁾ 2 re. vor + li. hinter der Achse ⁴⁾	D=54 D=54	ATE ATE
	U 1550 L/38 U 1700 U 1750 U 1800 U 1850 U 2100 U 2150 U 2400 U 2450				- HA 747.800 ⁵⁾	13.9574-7005.2 210275 13.9574-7006.2 210276 24.8190-0029.2 990156 24.8190-0030.2 990157 13.0441-5721.2 250123		D=57/48 D=57/48 Handbremsbetätigung Handbremsbetätigung Dichtungssatz	ATE ATE ATE ATE ATE
	U 1350 U 1550 L				- HA 747.362/364 ¹⁾	13.0460-6031.2 606031 24.8190-0403.2 620403	2	29581 15,0 /WE Warnkontakt L=315mm	ATE

MERCEDES BENZ (R107) 280 SL-560 SL (71-89)

	280 SL 280 SLC 350 SL 350 SLC 380 SL 380 SLC 450 SL 450 SLC 450 SLC 5.0 500 SL 500 SLC			09.74 07.85 09.74 03.80 02.71 02.80 09.71 02.80 03.80 08.85 03.80 08.81 03.73 09.80 03.73 09.80 04.78 02.80 05.80 08.85 05.78 07.81		03.6855-1202.4 300056		9" Tandem	ATE
	350 SL 350 SLC 450 SL 450 SLC		011507 009849 021171 007849	02.71 09.71 03.73 03.73		03.2123-1003.3 010175		Thz 23,81	ATE
	280 SL 280 SLC 350 SL 350 SLC 450 SL 450 SLC		000988 001211 012083 009850 021172 007850	09.74 09.74		03.2123-3402.3 010181		Thz 23,81	ATE
	280 SL 280 SLC 350 SL 350 SLC 380 SL 380 SLC 450 SL 450 SLC 450 SLC 5.0 500 SL	000989 001212 012084 010577 028345 011206	017463 028725	03.80 02.80 02.80 03.80 08.81 09.80 09.80 04.78 02.80 05.80		03.2023-0166.3 010015		Thz 23,81/19,05	ATE
	280 SL 380 SL 500 SL	017464 028726 003463		07.85 08.85 08.85		03.2025-0111.3 010033		Thz 25,40/19,05	ATE
	300 SL 420 SL 500 SL 560 SL			09.85 08.89 09.85 08.89 09.85 08.89 08.85 07.89	+ USA J AUS	03.2025-0211.3 010034		Thz 25,40/19,05	ATE
	280 SL 280 SLC 350 SL 350 SLC 450 SL 450 SLC			09.74 07.75 09.74 07.75 02.71 07.75 09.71 07.75 03.73 07.75 03.73 07.75		03.3508-8753.3 310049		Behälter + WE	
	350 SL 350 SLC		009599 005715	02.71 09.71		13.2571-8013.2 210123 13.2571-8014.2 210124 13.0441-5718.2 250120		D=57 D=57 Dichtungssatz	ATE ATE ATE
	280 SL 280 SLC 350 SL 350 SLC 450 SL 450 SLC 450 SLC 5.0 500 SLC	009600 005716	007869 008365 062584 030280 001627 001627	09.74 09.74 02.80 02.80 03.73 03.73 04.78 05.78		13.2601-8027.2 210159 13.2601-8028.2 210160 24.9440-8027.5 230051 24.9440-8028.5 230052 13.0441-6001.2 250126		D=60 D=60 D=40 D=40 Dichtungssatz	ATE ATE ATE ATE ATE
	280 SL 280 SLC 380 SL 380 SLC 450 SL 450 SLC	007870 008366		07.85 03.80 03.80 08.85 03.80 08.81 09.80 09.80		13.2601-8034.2 210166 13.2601-8033.2 210165 13.0441-6003.2 250128		D=60 D=60 Dichtungssatz	ATE ATE ATE

1) - RA 747.362/364 / - P 747.362/364 / - ess. AR 747.362/364 / - ET 747.362/364
 2) + RA 747.362/364 / + P 747.362/364 / + ess. AR 747.362/364 / + ET 747.362/364
 3) left i. front + right beh.axle / sinist.davant.+destr.diet.ass. / gauche dev. + droite derr.ess. / izqu.adel.+ derech.detrás eje
 4) right in front/left beh.axle / destr.davant.+sinist.diet.ass. / droite dev. + gauche derr.ess. / derech.adel.+ izqu.detrás eje
 5) - RA 747.800 / - P 747.800 / - ess. AR 747.800 / - ET 747.800



										
MERCEDES BENZ (R107) 280 SL-560 SL (71-89)										
	450 SLC 5.0	001628		02.80		13.2601-8034.2	210166	D=60 D=60 Dichtungssatz	ATE	
	500 SL			08.85		13.2601-8033.2	210165		ATE	
	500 SLC	001628		07.81		13.0441-6003.2	250128		ATE	
	300 SL			09.85	08.89	13.0441-4016.2	250081		Dichtungssatz	ATE
	420 SL			09.85	08.89					
	500 SL			09.85	08.89					
	560 SL			08.85	07.89	+ USA J AUS				
	350 SL		009599	02.71		13.0460-6027.2	606027	20011 15,0	ATE	
	350 SLC		005715	09.71						
	280 SL		007869	09.74		13.0460-9028.2	609028	20392 15,0 /WE	ATE	
	280 SLC		008365	09.74		24.8190-0401.2	620401	Warnkontakt L=95mm	ATE	
	350 SL	009600			02.80					
	350 SLC	005716			02.80					
	450 SL		062584	03.73						
	450 SLC		030280	03.73						
	450 SLC 5.0		001627	04.78						
	500 SLC		001627	05.78						
	280 SL	007870		07.85		13.0460-9029.2	609029	20341 16,7 /WE	ATE	
	280 SLC	008366		03.80		13.0460-0132.2	610132	Belagsatz-Zubehör	ATE	
	380 SL			03.80	08.85	24.8190-0401.2	620401	Warnkontakt L=95mm	ATE	
	380 SLC			03.80	08.81					
	450 SL	062585			09.80					
	450 SLC	030281			09.80					
	450 SLC 5.0	001628			02.80					
	500 SL			05.80	08.85					
	500 SLC	001628			07.81					
		300 SL			09.85	08.89	13.0460-4037.2	604037	21024 17,5 /WE	ATE
	420 SL			09.85	08.89	24.8190-0401.2	620401	Warnkontakt L=95mm	ATE	
	500 SL			09.85	08.89					
	560 SL			08.85	07.89	+ USA J AUS				
	280 SL		007869	09.74		24.0122-0106.1	422106	278 22,0 20,0 V L		
	280 SLC		008365	09.74						
	350 SL	009600			02.80					
	350 SLC	005716			02.80					
	450 SL		062584	03.73						
	450 SLC		030280	03.73						
	450 SLC 5.0		001627	04.78						
	500 SLC		001627	05.78						
		280 SL	007870		07.85		24.0122-0116.1	422116	278 22,0 19,4 V	
		280 SLC	008366		03.80					
	380 SL			03.80	08.85					
	380 SLC			03.80	08.81					
	450 SL	062585			09.80					
	450 SLC	030281			09.80					
	450 SLC 5.0	001628			02.80					
	500 SL			05.80	08.85					
	500 SLC	001628			07.81					
	300 SL			09.85	08.89	24.0122-0123.1	422123	284 22,0 19,4 V L +S +B		
	420 SL			09.85	08.89					
	500 SL			09.85	08.89					
	560 SL			08.85	07.89	+ USA J AUS				
	280 SL			09.74	07.85	83.7704-0421.3	330827	L=420		
	280 SLC			09.74	03.80					
	350 SL			02.71	02.80					
	350 SLC			09.71	02.80					
	380 SL			03.80	08.85					
	380 SLC			03.80	08.81					
	450 SL			03.73	09.80					
	450 SLC			03.73	09.80					
	450 SLC 5.0			04.78	02.80					
	500 SL			05.80	08.85					
	500 SLC			05.78	07.81					
	300 SL			09.85	08.89	24.5101-0346.3	331406	L=346		
	420 SL			09.85	08.89					
	500 SL			09.85	08.89					
	560 SL			08.85	07.89	+ USA J AUS				
	280 SL			09.74	07.85	13.2381-8027.2	210033	D=38	ATE	
	280 SLC			09.74	03.80	13.2381-8028.2	210034	D=38	ATE	
	300 SL			09.85	08.89	13.0441-3811.2	250067	Dichtungssatz	ATE	
	350 SL			02.71	02.80					
	350 SLC			09.71	02.80					
	380 SLC			03.80	08.81					
	450 SL			03.73	09.80	+ USA				
	380 SL			03.80	08.85	13.2381-8029.2	210035	D=38	ATE	
	420 SL			09.85	08.89	13.2381-8030.2	210036	D=38	ATE	
	450 SL			03.73	09.80	13.0441-3811.2	250067	Dichtungssatz	ATE	
450 SLC			03.73	09.80						
450 SLC 5.0			04.78	02.80						
500 SL			05.80	08.89						
500 SLC			05.78	07.81						
560 SL			08.85	07.89	+ USA J AUS					
	280 SL		006644	09.74		13.0460-4036.2	604036	21035 15,0	ATE	
	280 SLC		007435	09.74		13.0460-3804.2	603804	21035 15,0	ATE	
	350 SL		014752	02.71		13.0460-0029.2	610029	Belagsatz-Zubehör	ATE	
	350 SLC		013627	09.71		13.0460-0912.2	610912	Belagsatz-Zubehör	BDX	

1) + shim / + lamierino antirumore / + tôle anti-bruit / + placa anti-ruídos























MERCEDES BENZ (R107) 280 SL-560 SL (71-89)















	450 SL 450 SLC 450 SLC 5.0 500 SLC		058150 028254 001199 001199	03.73 03.73 04.78 05.78		13.0460-4036.2 13.0460-3804.2 13.0460-0029.2 13.0460-0912.2	604036 603804 610029 610912	+ Anti-Noise-Blech 1)	21035 15,0 21035 15,0 Belagsatz-Zubehör Belagsatz-Zubehör	ATE ATE ATE BDX
	280 SL 280 SLC 300 SL 350 SL 350 SLC 380 SL 380 SLC 420 SL 450 SL 450 SLC 450 SLC 5.0 500 SL 500 SLC 560 SL	006645 007436 014753 013628 058151 028255 001200 001200		07.85 03.80 09.85 02.80 02.80 03.80 03.80 09.85 09.80 09.80 02.80 05.80 07.81 08.85	07.85 03.80 08.89 02.80 02.80 08.85 08.81 08.89 09.80 09.80 02.80 08.89 07.81 07.89		13.0460-3804.2 13.0460-0029.2 13.0460-0912.2	603804 610029 610912		ATE ATE BDX
	280 SL 280 SLC 300 SL 350 SL 350 SLC 380 SLC			09.74 09.74 09.85 02.71 09.71 03.80	07.85 03.80 08.89 02.80 02.80 08.81	24.0110-0185.1	410185		279 10,0 8,3 +S +B	
	380 SL 420 SL 450 SL 450 SLC 450 SLC 5.0 500 SL 500 SLC 560 SL			03.80 09.85 03.73 03.73 04.78 05.80 05.78 08.85	08.85 08.89 09.80 09.80 02.80 08.89 07.81 07.89	24.0110-0185.1	410185		279 10,0 8,3 +S +B	
	350 SL 350 SLC			02.71 09.71	03.73 03.73	83.6204-0282.3	330309	2	L=280	
	280 SL 280 SLC 300 SL 350 SL 350 SLC			09.74 09.74 09.85 04.73 04.73	07.85 03.80 08.89 02.80 02.80	83.7704-0281.3	330804	2	L=280	
	380 SL 380 SLC 420 SL 450 SL 450 SLC 450 SLC 5.0 500 SL 500 SLC 560 SL			03.80 03.80 09.85 03.73 03.73 04.78 05.80 05.78 08.85	08.85 08.81 08.89 09.80 09.80 02.80 08.89 07.81 07.89	83.6204-0280.3	330732	2	L=280	
	280 SL 280 SLC 300 SL 350 SL 350 SLC 380 SL 380 SLC 420 SL 450 SL 450 SLC 450 SLC 5.0 500 SL 500 SLC 560 SL			09.74 09.74 09.85 02.71 09.71 03.80 03.80 09.85 03.73 03.73 04.78 05.80 05.78 08.85	07.85 03.80 08.89 02.80 02.80 08.85 08.81 08.89 09.80 09.80 02.80 08.89 07.81 07.89	03.0137-0128.2 03.0137-0171.2 03.0137-9002.2	650128 650171 669002		160 x 25 160 x 25 /Zub Bremsbacken-Zubehör	
	280 SL 280 SLC 350 SL 350 SLC		011427	09.74 09.74 02.71 09.71	07.85 03.80 02.80 02.80	24.2419-0937.3 03.0350-1926.2	030063 071926	+ ATE-Zylinder 2)	Gz 19,05 Gz Reparatursatz	FTE ATE
	280 SL 300 SL	011428		07.85 09.85	07.85 08.89	24.2419-0921.3	030050		Gz 19,05	
	280 SL 280 SLC		011568	09.74 09.74	07.85 03.80	03.2523-0811.3 03.0450-2311.2	040019 082311		Nz 23,81 Nz Reparatursatz	
	280 SL 300 SL	011569		07.85 09.85	07.85 08.89	03.2523-1210.3 03.0450-2311.2	040021 082311	+ Kolbenstange L=99 mm 3)	Nz 23,81 Nz Reparatursatz	
	280 SL 280 SLC 350 SL 350 SLC		011568	09.74 09.74 02.71 09.71	07.85 03.80 02.80 02.80	24.5901-0225.3	331288		L=225	
MERCEDES BENZ (R113) 230 SL-280 SL (63-71)										
	250 SL 280 SL	006619		11.67	01.68 03.71	03.6855-1202.4	300056		9" Tandem	ATE
	230 SL			01.63	12.65	03.2123-0609.3	010171		THz 23,81 20/12	ATE
	250 SL		002979	11.66		03.2123-0614.3	010172		THz 23,81 19/13	ATE
	250 SL 280 SL	002980		11.67	01.68 03.71	03.2123-1003.3	010175		THz 23,81	ATE

1) + shim / + lamierino antirumore / + tôle anti-bruit / + placa anti-ruídos

2) + ATE cylinder / + ATE - frizione idraulica / + cylindre ATE / + cilindrico de ATE

3) + piston rod L=99mm / + puntalino L=99mm / + tige de commande L=99mm / + vástago del émbolo L=99mm

											
MERCEDES BENZ (R113) 230 SL-280 SL (63-71)											
	250 SL 280 SL	002980		11.67	01.68 03.71		03.3508-8753.3	310049	Behälter + WE		
	230 SL 250 SL 280 SL			01.63 11.66 11.67	12.65 01.68 03.71		13.2571-9998.2 13.2571-9999.2 13.0441-5718.2	210133 210134 250120	D=57 D=57 Dichtungssatz	ATE ATE ATE	
	230 SL 250 SL 280 SL			01.63 11.66 11.67	12.65 01.68 03.71		13.0460-6027.2 13.0460-0026.2 13.0460-0910.2	606027 610026 610910	20011 15,0 Belagsatz-Zubehör Belagsatz-Zubehör	ATE ATE BDX	
	230 SL 250 SL 280 SL			01.63 11.66 11.67	12.65 01.68 03.71		24.0113-0111.1 24.0113-0112.1	413111 413112	253 12,7 11,1 273 12,6 11,0		
	230 SL 250 SL 280 SL			01.63 11.66 11.67	12.65 01.68 03.71		83.7704-0421.3	330827	2	L=420	
	250 SL 280 SL			11.66 11.67	01.68 03.71		13.2423-8009.2 13.2423-8010.2 13.0441-4206.2	210063 210064 250087	D=42 D=42 Dichtungssatz	ATE ATE ATE	
	250 SL 280 SL			11.66 11.67	01.68 03.71		13.0460-4036.2 13.0460-3804.2 13.0460-0029.2	604036 603804 610029	+ Anti-Noise-Blech 1)	21035 15,0 21035 15,0 Belagsatz-Zubehör	ATE ATE ATE
	250 SL 280 SL			11.66 11.67	01.68 03.71		24.0110-0185.1	410185		279 10,0 8,3 +S +B	
	230 SL 250 SL 280 SL			01.63 11.66 11.67	12.65 01.68 03.71		83.6104-0210.3 83.6204-0220.3	330473 330308	D D	L=210 L=220	
	230 SL			01.63	12.65		83.6104-0220.3 83.6204-0220.3	330474 330308	D D	L=220 L=220	
	250 SL 280 SL			11.66 11.67	01.68 03.71		03.3219-3401.3	020049		Rz 19,05	
	250 SL 280 SL			11.66 11.67	01.68 03.71		03.0137-0128.2 03.0137-0171.2 03.0137-9002.2	650128 650171 669002		160 x 25 160 x 25 /Zub Bremsbacken-Zubehör	

MERCEDES BENZ (R129) SL-Klasse (89-93)											
	300 SL 300 SL 24 500 SL			06.89 06.89 06.89	07.93 07.93 07.93		03.2025-0211.3	010034		Thz 25,40/19,05	ATE
	300 SL 300 SL 24 500 SL			06.89 06.89 06.89	07.93 07.93 07.93		24.9442-8003.5 24.9442-8004.5 13.0441-4214.2	230053 230054 250091	D=42/38 D=42/38 Dichtungssatz	ATE ATE ATE	
	600 SL V12			06.92	07.93		13.0441-4214.2	250091		Dichtungssatz	ATE
	300 SL 300 SL 24 500 SL 600 SL V12			06.89 06.89 06.89 06.92	07.93 07.93 07.93 07.93		13.0460-4201.2 13.0460-0219.2 24.8190-0401.2	604201 610219 620401	4	21153 17,5 /WE Belagsatz-Zubehör Warnkontakt L=95mm	ATE ATE
	300 SL 300 SL 24 500 SL			06.89 06.89 06.89	07.93 07.93 07.93		24.0128-0103.1 13.8190-0242.1	428103 990124	4	300 28,0 25,4 V L +B Halterschraube	
	600 SL V12			06.92	07.93		24.0130-0121.1 24.0130-0122.1 13.8190-0242.1	430121 430122 990124	D D 4	320 30,0 28,0 V L +B 320 30,0 28,0 V L +B Halterschraube	
	300 SL 300 SL 24 500 SL 600 SL V12			06.89 06.89 06.89 06.92	07.93 07.93 07.93 07.93		24.5101-0346.3	331406	2	L=346	
	300 SL 300 SL 24 500 SL			06.89 06.89 06.89	07.93 07.93 07.93		13.2381-8035.2 24.9238-8035.5 24.9238-8036.5 13.0441-3817.2	210037 230025 230026 250071	D=38 D=38 D=38 Dichtungssatz	ATE ATE ATE ATE	
	600 SL V12			06.92	07.93		13.2421-8025.2 13.2421-8026.2 13.0441-4216.2	210061 210062 250093	D=42 D=42 Dichtungssatz	ATE ATE ATE	
	300 SL 300 SL 24 500 SL			06.89 06.89 06.89	07.93 07.93 07.93		13.0460-3805.2 13.0470-3805.2 13.0460-0215.2 24.8190-0401.2	603805 LD3805 610215 620401	4	21197 15,0 /WE 21197 15,0 /WE Belagsatz-Zubehör Warnkontakt L=95mm	ATE ATE ATE
	600 SL V12			06.92	07.93		13.0460-4047.2 13.0470-4047.2 13.0460-0236.2 24.8190-0401.2	604047 LD4047 610236 620401	4	21305 15,7 /WE 21305 15,7 /WE Belagsatz-Zubehör Warnkontakt L=95mm	ATE ATE ATE
	300 SL 300 SL 24 500 SL 600 SL V12			06.89 06.89 06.89 06.92	07.93 07.93 07.93 07.93		24.0109-0103.1	409103		278 9,0 7,3 +B	
	300 SL 300 SL 24 500 SL 600 SL V12			06.89 06.89 06.89 06.92	07.93 07.93 07.93 07.93		24.0122-0218.1	422218		300 22,0 19,4 V L +B	
	300 SL 300 SL 24 500 SL 600 SL V12			06.89 06.89 06.89 06.92	07.93 07.93 07.93 07.93		83.7704-0281.3	330804	2	L=280	

1) + shim / + lamierino antirumore / + tôle anti-bruit / + placa anti-ruidos

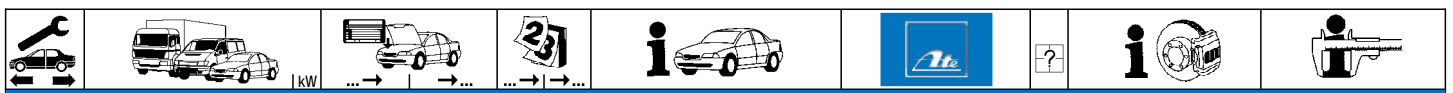

MERCEDES BENZ (R129) SL-Klasse (89-93)

	300 SL 300 SL 24 500 SL 600 SL V12			06.89 06.89 06.89 06.92	07.93 07.93 07.93 07.93		03.0137-0170.2	650170			164 x 20 /Zub
	300 SL 300 SL 24 500 SL 600 SL V12			06.89 06.89 06.89 06.92	07.93 07.93 07.93 07.93		24.3727-0464.2 24.3727-0468.2 24.3727-0469.2	580464 580468 580469	1	<input type="checkbox"/> <input type="checkbox"/> <input type="checkbox"/>	L=2297 L=1044 L=1014
	300 SL 300 SL 24 500 SL 600 SL V12			06.89 06.89 06.89 06.92	07.93 07.93 07.93 07.93		24.3727-0468.2 24.3727-0469.2	580468 580469	<input type="checkbox"/> <input type="checkbox"/>		L=1044 L=1014
	300 SL 300 SL 24			06.89 06.89	07.93 07.93		24.2419-0915.3 24.2419-1703.3	030045 030097	+ GG ¹⁾ + ALU ²⁾		Gz 19,05 Gz 19,05
	300 SL 300 SL 24			06.89 06.89	07.93 07.93		03.2523-1310.3	040022			Nz 23,81

MERCEDES BENZ (R198) 300 SL (55-60)

	300 SL		002953	01.55			03.3508-3600.3	310030			Behälter
	300 SL	002954		12.60			03.3509-0600.3	310065			Behälter

MERCEDES BENZ (W100) 600 (64-81)

	600			01.64	05.81		83.7704-0421.3	330827	2		L=420
--	-----	--	--	-------	-------	--	----------------	--------	---	--	-------

MERCEDES BENZ (W105) 219 (56-59)















	219			01.56	12.59		03.3126-0505.3	010294			Hz 26,99	ATE
	219			01.56	12.59		83.7704-0320.3	330851	2		L=320	
	219			01.56	12.59		03.2728-2101.3 03.2728-2201.3 03.0402-1128.2	020008 020009 060027	<input type="checkbox"/> <input type="checkbox"/> <input type="checkbox"/>		Rz 28,57 Rz 28,57 Rz Reparatursatz	
	219			01.56	12.59		83.6104-0210.3 83.6204-0220.3	330473 330308	<input type="checkbox"/> <input type="checkbox"/>		L=210 L=220	
	219			01.56	12.59		03.3223-0102.3	020090			Rz 23,81	

MERCEDES BENZ (W108) 250 S-300 SEb (65-72)

	280 S 280 SE 280 SE/SEL 3.5 280 SEL	015700 014781		09.72 09.72 03.71 01.68	07.93 07.93 08.72 03.71		03.6855-1202.4	300056			9" Tandem	ATE
	250 S 250 SE 300 SEb		058443 045293 002589	07.65 08.65 08.65			03.2123-0614.3	010172			Thz 23,81 19/13	ATE
	250 S 250 SE 280 S/SE 280 SE/SEL 3.5 280 SEL 300 SEb	058444 045294		03.69 01.68 11.67 03.71 01.68	07.93 07.93 09.72 08.72 03.71		03.2123-1003.3	010175			Thz 23,81	ATE
	250 S 250 SE 280 S/SE 280 SE/SEL 3.5 280 SEL 300 SEb	058444 045294		03.69 01.68 11.67 03.71 01.68	07.93 07.93 09.72 08.72 03.71		03.3508-8753.3	310049			Behälter + WE	
	250 S 250 SE 280 S 280 SE 280 SEL 300 SEb		075175 081818 081818	07.65 08.65 11.67 11.67 01.68	03.69 01.68 09.72 09.72 08.65		13.2571-9998.2 13.2571-9999.2 13.0441-5718.2	210133 210134 250120	<input type="checkbox"/> <input type="checkbox"/>		D=57 D=57 Dichtungssatz	ATE ATE ATE
	280 S 280 SE 280 SE/SEL 3.5 280 SEL	075176 081819		09.72 09.72 03.71	07.93 07.93 03.71		13.2571-8011.2 13.2571-8012.2 13.0441-5718.2	210121 210122 250120	<input type="checkbox"/> <input type="checkbox"/>		D=57 D=57 Dichtungssatz	ATE ATE ATE
	250 S 250 SE 280 S 280 SE 280 SE/SEL 3.5 280 SEL 300 SEb			07.65 08.65 11.67 11.67 03.71 01.68 08.65	03.69 01.68 09.72 09.72 08.72 03.71 12.67		13.0460-6027.2 13.0460-0026.2 13.0460-0910.2	606027 610026 610910			20011 15,0 Belagsatz-Zubehör Belagsatz-Zubehör	ATE ATE BDX

¹⁾ + cast iron / + ghisa / + fonte grise / + fundición de gris
²⁾ + aluminium / + alluminio / + aluminium / + aluminio



MERCEDES BENZ (W108) 250 S-300 SEb (65-72)											
	250 S 250 SE 280 S 280 SE 280 SEL		075175 081818 081818	07.65 08.65 11.67 11.67 01.68	03.69 01.68		24.0113-0112.1	413112		273 12,6 11,0	
	300 SEb			08.65	12.67		24.0113-0111.1	413111		253 12,7 11,1	
	250 S 250 SE 280 S 280 SE 280 SE/SEL 3.5 280 SEL 300 SEb			07.65 08.65 11.67 11.67 03.71 01.68 08.65	03.69 01.68 09.72 09.72 08.72 03.71 12.67		83.7704-0421.3	330827	2	L=420	
	250 S 250 SE 280 S 280 SE 280 SEL 300 SEb		0034763 0035762 0035738	07.65 08.65 11.67 11.67 01.68 08.65	03.69 01.68		13.2423-8009.2 13.2423-8010.2 13.0441-4206.2	210063 210064 250087	<input type="checkbox"/> <input type="checkbox"/>	D=42 D=42 Dichtungssatz	ATE ATE ATE
	280 S 280 SE 280 SE/SEL 3.5 280 SEL	0034764 0035763 0035739		09.72 09.72 03.71 03.71	09.72 09.72 08.72 03.71		13.2353-8003.2 13.2353-8004.2 13.0441-3504.2	210016 210017 250050	<input type="checkbox"/> <input type="checkbox"/>	D=35 D=35 Dichtungssatz	ATE ATE ATE
	250 S 250 SE 280 S 280 SE 280 SE/SEL 3.5 280 SEL 300 SEb			07.65 08.65 11.67 11.67 03.71 01.68 08.65	03.69 01.68 09.72 09.72 08.72 03.71 12.67		13.0460-4036.2 13.0460-3804.2 13.0460-0029.2	604036 603804 610029	+ Anti-Noise-Blech 1)	21035 15,0 21035 15,0 Belagsatz-Zubehör	ATE ATE ATE
	250 S 250 SE 280 S 280 SE 280 SE/SEL 3.5 280 SEL 300 SEb			07.65 08.65 11.67 11.67 03.71 01.68 08.65	03.69 01.68 09.72 09.72 08.72 03.71 12.67		24.0110-0185.1	410185		279 10,0 8,3 +S +B	
	250 S 250 SE 280 S 280 SE 280 SEL 300 SEb		0034763 0035762 0035738	07.65 08.65 11.67 11.67 01.68 08.65	03.69 01.68		83.6104-0241.3 83.6204-0220.3	330731 330308	<input type="checkbox"/> <input type="checkbox"/>	L=240 L=220	
	280 S 280 SE 280 SE/SEL 3.5 280 SEL	0034764 0035763 0035739		09.72 09.72 03.71 03.71	09.72 09.72 08.72 03.71		83.7704-0320.3 83.6204-0220.3	330851 330308	<input type="checkbox"/> <input type="checkbox"/>	L=320 L=220	
	250 S 250 SE 280 S 280 SE 280 SE/SEL 3.5 280 SEL 300 SEb			07.65 08.65 11.67 11.67 03.71 01.68 08.65	03.69 01.68 09.72 09.72 08.72 03.71 12.67		03.0137-0128.2 03.0137-0171.2 03.0137-9002.2	650128 650171 669002		160 x 25 160 x 25 /Zub Bremsbacken-Zubehör	
	280 S 280 SE 280 SEL	027623 028986 029326		09.72 09.72 03.71	09.72		24.2419-0937.3 03.0350-1926.2	030063 071926	+ ATE-Zylinder 2)	Gz 19,05 Gz Reparatursatz	FTE ATE
	280 S 280 SE 280 SEL	027623 028986 029326		09.72 09.72 03.71	09.72		03.2523-0811.3 03.0450-2311.2	040019 082311		Nz 23,81 Nz Reparatursatz	
	280 S 280 SE 280 SEL	027623 028986 029326		09.72 09.72 03.71	09.72		24.5901-0225.3	331288		L=225	
MERCEDES BENZ (W109) 300 SEL (65-72)											
	300 SEL 2.8 300 SEL 3.5 300 SEL 6.3	000979		01.70 09.69 12.67	09.72 09.72		03.6855-1202.4	300056		9" Tandem	ATE
	300 SEL	002130		08.65			03.2123-0614.3	010172		THz 23,81 19/13	ATE
	300 SEL 300 SEL 2.8 300 SEL 3.5 300 SEL 6.3	002131		11.67 12.67 09.69 12.67	11.70 09.72 09.72		03.2123-1003.3	010175		THz 23,81	ATE
	300 SEL 300 SEL 2.8 300 SEL 3.5 300 SEL 6.3	002131		12.67 09.69 12.67	11.67 01.70 09.72 09.72		03.3508-8753.3	310049		Behälter + WE	
	300 SEL 300 SEL 2.8			08.65 12.67	11.67 01.70		13.2571-9998.2 13.2571-9999.2 13.0441-5718.2	210133 210134 250120	<input type="checkbox"/> <input type="checkbox"/>	D=57 D=57 Dichtungssatz	ATE ATE ATE
	300 SEL 3.5 300 SEL 6.3			09.69 12.67	09.72 09.72		13.2571-8011.2 13.2571-8012.2 13.0441-5718.2	210121 210122 250120	<input type="checkbox"/> <input type="checkbox"/>	D=57 D=57 Dichtungssatz	ATE ATE ATE

1) + shim / + lamierino antirumore / + tôle anti-bruit / + placa anti-ruídos

2) + ATE cylinder / + ATE - frizione idraulica / + cylindre ATE / + cilindrico de ATE



MERCEDES BENZ (W109) 300 SEL (65-72)













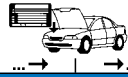







	300 SEL 300 SEL 2.8 300 SEL 3.5 300 SEL 6.3			08.65 12.67 09.69 12.67	11.67 01.70 09.72 09.72		13.0460-6027.2 13.0460-0026.2 13.0460-0910.2	606027 610026 610910		20011 15,0 Belagsatz-Zubehör Belagsatz-Zubehör	ATE ATE BDX
	300 SEL 300 SEL 2.8			08.65 12.67	11.67 01.70		24.0113-0112.1	413112		273 12,6 11,0	
	300 SEL 300 SEL 2.8 300 SEL 3.5 300 SEL 6.3			08.65 12.67 09.69 12.67	11.67 01.70 09.72 09.72		83.7704-0421.3	330827	2	L=420	
	300 SEL 300 SEL 2.8			08.65 12.67	11.67 01.70		83.6104-0470.3	330253	2	L=470	
	300 SEL 300 SEL 2.8		002210	08.65 12.67	11.67 01.70		13.2423-8009.2 13.2423-8010.2 13.0441-4206.2	210063 210064 250087		D=42 D=42 Dichtungssatz	ATE ATE ATE
	300 SEL 2.8 300 SEL 3.5 300 SEL 6.3	002211 003549		01.70 09.69 09.72	01.70 09.72 09.72		13.2353-8003.2 13.2353-8004.2 13.0441-3504.2	210016 210017 250050		D=35 D=35 Dichtungssatz	ATE ATE ATE
	300 SEL 300 SEL 2.8 300 SEL 3.5 300 SEL 6.3		003548	12.67			13.0441-4206.2	250087		Dichtungssatz	ATE
	300 SEL 300 SEL 2.8 300 SEL 3.5 300 SEL 6.3			08.65 12.67 09.69 12.67	11.67 01.70 09.72 09.72		13.0460-4036.2 13.0460-3804.2 13.0460-0029.2	604036 603804 610029		+ Anti-Noise-Blech ¹⁾ 21035 15,0 21035 15,0 Belagsatz-Zubehör	ATE ATE ATE
	300 SEL 300 SEL 2.8 300 SEL 3.5 300 SEL 6.3			08.65 12.67 09.69 12.67	11.67 01.70 09.72 09.72		24.0110-0185.1	410185		279 10,0 8,3 +S +B	
	300 SEL 300 SEL 2.8 300 SEL 3.5 300 SEL 6.3			08.65 12.67 09.69 12.67	11.67 01.70 09.72 09.72		83.6204-0350.3	330382	2	L=350	
	300 SEL 300 SEL 2.8 300 SEL 3.5 300 SEL 6.3			08.65 12.67 09.69 12.67	11.67 01.70 09.72 09.72		03.0137-0128.2 03.0137-0171.2 03.0137-9002.2	650128 650171 669002		160 x 25 160 x 25 /Zub Bremsbacken-Zubehör	
	300 SEL 2.8	001859		01.70			24.2419-0937.3 03.0350-1926.2	030063 071926		+ ATE-Zylinder ²⁾ Gz 19,05 Gz Reparatursatz	FTE ATE
	300 SEL 2.8	001859		01.70			03.2523-0811.3 03.0450-2311.2	040019 082311		Nz 23,81 Nz Reparatursatz	
	300 SEL 2.8	001859		01.70			24.5901-0225.3	331288		L=225	

MERCEDES BENZ (W110) 190 c-230 (61-68)

	190 c. Dc 200/ D 230			08.65 07.65 07.65	02.68 02.68 02.67		03.2123-0609.3	010171		+ Bremsgerät (2-Kreis) ³⁾ Thz 23,81 20/12	ATE
	190 c 190 Dc 200/ D 230	064106 099642		08.65 08.65 07.65 07.65	02.68 02.68 02.67 02.67		13.2571-9998.2 13.2571-9999.2 13.0441-5718.2	210133 210134 250120		D=57 D=57 Dichtungssatz	ATE ATE ATE
	190 c 190 Dc 200/ D 230	064106 099642		08.65 08.65 07.65 07.65	02.68 02.68 02.67 02.67		13.0460-6027.2 13.0460-0026.2	606027 610026		20011 15,0 Belagsatz-Zubehör	ATE ATE
	190 c 190 Dc 200/ D 230	064106 099642		08.65 08.65 07.65 07.65	02.68 02.68 02.67 02.67		24.0113-0111.1	413111		253 12,7 11,1	
	190 c 190 Dc		064105 099641	04.61 04.61			83.6104-0440.3	330714	2	L=440	
	190 c 190 Dc 200/ D 230	064106 099642		08.65 08.65 07.65 07.65	02.68 02.68 02.67 02.67		83.7704-0421.3	330827	2	L=420	
	190 c 190 Dc		064105 099641	04.61 04.61			03.2728-2101.3 03.2728-2201.3 03.0402-1128.2	020008 020009 060027		Rz 28,57 Rz 28,57 Rz Reparatursatz	
	190 c. Dc 200/ D 230			04.61 07.65 07.65	08.65 02.68 02.67		83.6104-0210.3 83.6204-0220.3	330473 330308		L=210 L=220	
	190 c 190 Dc		064105 099641	04.61 04.61			03.3223-0102.3	020090		Rz 23,81	
	190 c 190 Dc 200/ D 230	064106 099642		08.65 08.65 07.65 07.65	02.68 02.68 02.67 02.67		03.3219-3401.3	020049		Rz 19,05	

¹⁾ + shim / + lamierino antirumore / + tôle anti-bruit / + placa anti-ruídos
²⁾ + ATE cylinder / + ATE - frizione idraulica / + cylindre ATE / + cilindrico de ATE
³⁾ + booster unit (2 circuit) / + servofreno (doppio circuito) / + servo-frein (deux circuits) / + servofreno (2 circuitos)



								
MERCEDES BENZ (W111) 220-280 (59-71)								
	280 SE/C 280 SE/C 3.5	001504		08.69 05.71 06.71		03.6855-1202.4	300056	9" Tandem ATE
	220 b 220 Sb 220 SEb Cabrio 220 SEb Coupe 220 SEb Lim. 230 S	048977 108750 049723 049449 049462		08.65 07.65 10.65 10.65 08.65 07.65 01.68		03.2123-0609.3	010171	THz 23,81 20/12 ATE
	250 SE/C		088724	08.65		03.2123-0614.3	010172	THz 23,81 19/13 ATE
	250 SE/C 280 SE/C 280 SE/C 3.5	088725		12.67 05.71 08.69 06.71		03.2123-1003.3	010175	THz 23,81 ATE
	220 b 220 Sb 220 SEb Cabrio 220 SEb Coupe 220 SEb Lim.	048976 048976 108749 049722 049448 049461		05.59 05.59 05.59 09.60 09.60 08.59		03.3508-0401.3	310014	Behälter
	250 SE/C 280 SE/C 280 SE/C 3.5	088725		12.67 05.71 08.69 06.71		03.3508-0801.3	310023	Behälter
						03.3508-8753.3	310049	Behälter + WE
	220 b 220 Sb 220 SEb Cabrio 220 SEb Coupe 220 SEb Lim. 230 S 250 SE/C 280 SE/C	048977 070638 026841		08.65 07.65 09.60 10.65 09.60 10.65 08.65 01.68 08.65 12.67 11.67		13.2571-9998.2 13.2571-9999.2 13.0441-5718.2	210133 210134 250120	D=57 D=57 Dichtungssatz ATE ATE ATE
	280 SE/C 280 SE/C 3.5	005158		05.71 08.69 06.71		13.2571-8011.2 13.2571-8012.2 13.0441-5718.2	210121 210122 250120	D=57 D=57 Dichtungssatz ATE ATE ATE
	220 b 220 Sb 220 SEb Cabrio 220 SEb Coupe 220 SEb Lim. 230 S 250 SE/C 280 SE/C 280 SE/C 3.5	048977 070638 026841		08.65 07.65 09.60 10.65 09.60 10.65 08.65 01.68 08.65 12.67 11.67 05.71 08.69 06.71		13.0460-6027.2 13.0460-0026.2 13.0460-0910.2	606027 610026 610910	20011 15,0 ATE ATE BDX
	220 b 220 Sb 220 SEb Cabrio 220 SEb Coupe 220 SEb Lim. 230 S	048977 070638 026841		08.65 07.65 09.60 10.65 09.60 10.65 08.65 01.68		24.0113-0111.1	413111	253 12,7 11,1
	250 SE/C 280 SE/C		005157	08.65 12.67 11.67		24.0113-0112.1	413112	273 12,6 11,0
	220 b 220 Sb 220 SEb Lim. 220 SEb Coupe	023661 049856 016976	048976 070637 026840			83.6104-0440.3	330714	2 L=440
	220 b 220 Sb 220 SEb Cabrio 220 SEb Coupe 220 SEb Lim. 230 S 250 SE/C 280 SE/C 280 SE/C 3.5	048977 070638 026651 026841		08.65 07.65 09.60 10.65 10.65 08.65 01.68 08.65 12.67 11.67 05.71 08.69 06.71		83.7704-0320.3 83.7704-0421.3	330851 330827	2 2 L=420
	220 b 220 Sb 220 SEb Lim.	048976 070637 026840		05.59 05.59 08.59		03.2728-2101.3 03.2728-2201.3 03.0402-1128.2	020008 020009 060027	Rz 28,57 Rz 28,57 Rz Reparatursatz
	250 SE/C 280 SE/C		003467	08.65 12.67 11.67		13.2423-8009.2 13.2423-8010.2 13.0441-4206.2	210063 210064 250087	D=42 D=42 Dichtungssatz ATE ATE ATE
	280 SE/C 280 SE/C 3.5	003468		05.71 08.69 06.71		13.2353-8003.2 13.2353-8004.2 13.0441-3504.2	210016 210017 250050	D=35 D=35 Dichtungssatz ATE ATE ATE
	250 SE/C 280 SE/C 280 SE/C 3.5			08.65 11.67 08.69 06.71		13.0460-4036.2 13.0460-3804.2 13.0460-0029.2	604036 603804 610029	+ Anti-Noise-Blech ³⁾ 21035 15,0 21035 15,0 Belagsatz-Zubehör ATE ATE ATE
	250 SE/C 280 SE/C 280 SE/C 3.5			08.65 11.67 08.69 06.71		24.0110-0185.1	410185	279 10,0 8,3 +S +B
	220 b 220 Sb 220 SEb Cabrio 220 SEb Coupe 220 SEb Lim. 230 S			05.59 05.59 07.65 09.60 10.65 09.60 10.65 08.59 08.65 07.65 01.68		83.6104-0210.3 83.6204-0220.3	330473 330308	L=210 L=220

1) - booster unit / - servofreno / - servo-frein / - servofreno

2) + booster unit / + servofreno / + servo-frein / + servofreno

3) + shim / + lamierino antirumore / + tôle anti-bruit / + placa anti-ruidos

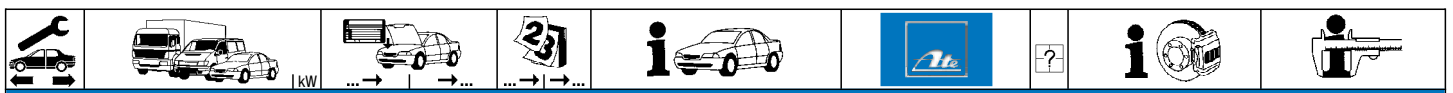

MERCEDES BENZ (W111) 220-280 (59-71)

	250 SE/C 280 SE/C		003467	08.65 11.67	12.67	83.6104-0241.3 83.6204-0220.3	330731 330308			L=240 L=220	
	280 SE/C 280 SE/C 3.5	003468		05.71 08.69	06.71	83.7704-0320.3 83.6204-0220.3	330851 330308			L=320 L=220	
	220 b 220 Sb 220 SEb Lim.		048976 070637 026840	05.59 05.59 08.59		03.3223-0102.3	020090			Rz 23,81	
	220 b 220 Sb 220 SEb Cabrio 220 SEb Coupe 220 SEb Lim. 230 S	048977 070638 026841		08.65 07.65 09.60 09.60 08.65 07.65	08.65 07.65 10.65 10.65 08.65 01.68	03.3219-3401.3	020049			Rz 19,05	
	220 b 220 Sb 220 SEb Cabrio 220 SEb Coupe 220 SEb Lim. 230 S 250 SE/C 280 SE/C 280 SE/C 3.5			05.59 05.59 09.60 09.60 08.59 07.65 08.65 11.67 08.69	08.65 07.65 10.65 10.65 08.65 01.68 12.67 05.71 06.71	03.0137-0128.2 03.0137-0171.2 03.0137-9002.2	650128 650171 669002			160 x 25 160 x 25 /Zub Bremsbacken-Zubehör	
	280 SE/C	002864		05.71		24.2419-0937.3 03.0350-1926.2	030063 071926		+ ATE-Zylinder 1)	Gz 19,05 Gz Reparatursatz	FTE ATE
	280 SE/C	002864		05.71		03.2523-0811.3 03.0450-2311.2	040019 082311			Nz 23,81 Nz Reparatursatz	
	280 SE/C	002864		05.71		24.5901-0225.3	331288			L=225	

MERCEDES BENZ (W112) 300 SE (65-67)

	300 SE	005867		12.67		13.2571-9998.2 13.2571-9999.2 13.0441-5718.2	210133 210134 250120			D=57 D=57 Dichtungssatz	ATE ATE ATE
	300 SE	005867		12.67		13.0460-6027.2	606027			20011 15,0	ATE
	300 SE	005867		12.67		24.0113-0111.1	413111			253 12,7 11,1	
	300 SE			01.65	12.67	83.6204-0350.3	330382	2		L=350	

MERCEDES BENZ (W114) 230.6-280 CE (67-76)

	230.6 250 250 C 250 CE 280 280 C 280 CE 280 E			09.67 07.67 10.68 10.68 04.72 06.72 04.72 04.72	10.76 06.76 06.76 04.72 09.76 07.76 07.76 09.76	03.6850-0202.4	300043			9"	ATE
	230.6 250 250 C 250 CE			09.67 07.67 10.68 10.68	10.76 06.76 06.76 04.72	03.2123-1003.3	010175			THz 23,81	ATE
	280 280 C 280 CE 280 E			04.72 06.72 04.72 04.72	09.76 07.76 07.76 09.76	03.2123-3402.3	010181			THz 23,81	ATE
	230.6 250 250 C 250 CE 280 280 C 280 CE 280 E			09.67 07.67 10.68 10.68 04.72 06.72 04.72 04.72	10.76 06.76 06.76 04.72 09.76 07.76 07.76 09.76	03.3508-8753.3	310049			Behälter + WE	
	230.6 250 250 C 250 CE		203606	09.67 07.67 10.68	06.76	13.2571-9998.2 13.2571-9999.2 13.0441-5718.2	210133 210134 250120			D=57 D=57 Dichtungssatz	ATE ATE ATE
	230.6 250 C 250 CE 280 280 C 280 CE 280 E	203607 008134 020273		10.76 06.76 04.72 06.72 04.72 04.72	10.76 06.76 09.76 07.76 07.76 09.76	13.2601-9996.2 13.2601-9997.2 13.0441-6001.2	210176 210177 250126			D=60 D=60 Dichtungssatz	ATE ATE ATE

1) + ATE cylinder / + ATE - frizione idraulica / + cylindre ATE / + cilindrico de ATE



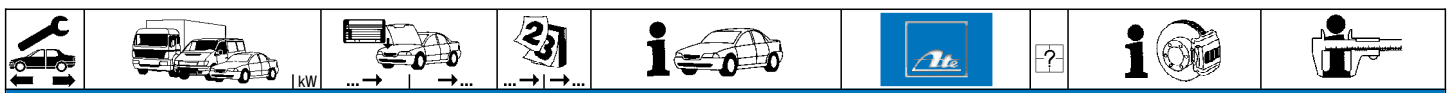

















MERCEDES BENZ (W114) 230.6-280 CE (67-76)

	230.6 250 250 C 250 CE		203606 008133 020272	09.67 07.67 10.68 10.68	06.76	13.0460-6027.2 13.0460-0026.2 13.0460-0910.2	606027 610026 610910		20011 15,0 Belagsatz-Zubehör Belagsatz-Zubehör	ATE ATE BDX
	230.6 250 C 250 CE 280 280 C 280 CE 280 E	203607 008134 020273		10.76 06.76 04.72 09.76 06.72 07.76 04.72 09.76		13.0460-9028.2 13.0460-0027.2 13.0460-0911.2	609028 610027 610911		20392 15,0 /WE Belagsatz-Zubehör Belagsatz-Zubehör	ATE ATE BDX
	230.6 250 250 C 250 CE		089801 068407 007085 017599	09.67 07.67 10.68 10.68		24.0113-0112.1	413112		273 12,6 11,0	
	230.6 250 250 C 250 CE	089802 068408 007086 017600	203606	05.72 05.72 04.72		24.0113-0113.1	413113		274 12,6 11,0	
	230.6 250 250 C 280 280 C 280 CE 280 E	203607		10.76 06.72 06.72 04.72 06.72 07.76 04.72 09.76		24.0113-0137.1	413137		278 12,6 10,6 +B	
	230.6 250 250 C 250 CE 280 280 C 280 CE 280 E			09.67 07.67 10.68 10.68 04.72 09.76 06.72 07.76 04.72 09.76	10.76 06.76 06.76 04.72	83.7704-0421.3	330827	2	L=420	
	230.6 250 250 C 250 CE			09.67 07.67 10.68 10.68	12.70 12.70 12.70 12.70	13.2381-8030.2 13.2381-8029.2 13.0441-3811.2	210036 210035 250067	<input type="checkbox"/> Achtung: Kolbenstellung ändern ¹⁾ <input type="checkbox"/> Achtung: Kolbenstellung ändern ¹⁾	D=38 D=38 Dichtungssatz	ATE ATE ATE
	230.6 250 250 C 250 CE 280 280 C 280 CE 280 E			01.71 01.71 01.71 01.71 04.72 09.76 06.72 07.76 04.72 09.76	10.76 06.76 06.76 04.72	13.2381-8027.2 13.2381-8028.2 13.0441-3811.2	210033 210034 250067	<input type="checkbox"/> <input type="checkbox"/>	D=38 D=38 Dichtungssatz	ATE ATE ATE
	230.6 250 250 C 250 CE 280 280 C 280 CE 280 E			09.67 07.67 10.68 10.68 04.72 09.76 06.72 07.76 04.72 09.76	10.76 06.76 06.76 04.72	13.0460-4036.2 13.0460-3804.2 13.0460-0029.2 13.0460-0912.2	604036 603804 610029 610912	+ Anti-Noise-Blech ²⁾	21035 15,0 21035 15,0 Belagsatz-Zubehör Belagsatz-Zubehör	ATE ATE ATE BDX
	230.6 250 250 C 250 CE 280 280 C 280 CE 280 E			09.67 07.67 10.68 10.68 04.72 09.76 06.72 07.76 04.72 09.76	10.76 06.76 06.76 04.72	24.0110-0185.1	410185		279 10,0 8,3 +S +B	
	230.6 250 250 C 250 CE		065606 055234 005143 012571	09.67 07.67 10.68 10.68		83.6204-0240.3	330718	2	L=240	
	230.6 250 250 C 250 CE 280 280 C 280 CE 280 E	065607 055235 005144 012572		03.73 03.73 03.73 04.72 04.72 03.73 04.72 03.73		83.6204-0280.3	330732	2	L=280	
	230.6 250 250 C 280 280 C 280 CE 280 E			04.73 04.73 04.73 04.73 04.73 07.76 04.73 09.76	10.76 06.76 06.76 09.76	83.7704-0281.3	330804	2	L=280	
	230.6 250 250 C 250 CE			09.67 07.67 10.68 10.68	10.76 06.76 06.76 04.72	03.0137-0128.2 03.0137-0171.2 03.0137-9002.2	650128 650171 669002		160 x 25 160 x 25 /Zub Bremsbacken-Zubehör	













¹⁾ attn.:change piston position / att.cambiare posizione pistone / montage devant l'essieu / instalación delante del eje

²⁾ + shim / + lamierino antirumore / + tôle anti-bruit / + placa anti-ruídos















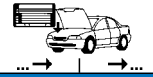









										
MERCEDES BENZ (W114) 230.6-280 CE (67-76)										
	280 280 C 280 CE 280 E			04.72 06.72 04.72 04.72	09.76 07.76 07.76 09.76	03.0137-0128.2 03.0137-0171.2 03.0137-9002.2	650128 650171 669002	160 x 25 160 x 25 /Zub Bremsbacken-Zubehör		
	230.6 250 250 C 250 CE 280 280 C 280 CE 280 E	101229 021787 108227		09.67 07.67 10.68 10.68 04.72 06.72 04.72 04.72	10.76 06.76 06.76 06.76 09.76 07.76 07.76 09.76	24.3727-0406.2 24.3727-0407.2	580406 580407	1  + Linkslenker ¹⁾ 2 	L=1696 L=1488	
	230.6 250 250 C 250 CE 280 280 C 280 CE 280 E			09.67 07.67 10.68 10.68 04.72 06.72 04.72 04.72	10.76 06.76 06.76 04.72 09.76 07.76 07.76 09.76	24.2419-0937.3 03.3508-1706.3 03.0350-1926.2	030063 310024 071926	+ ATE-Zylinder ²⁾	Gz 19,05 Behälter Gz Reparatursatz	FTE ATE
	230.6 250 250 C 250 CE 280 280 C 280 CE 280 E			09.67 07.67 10.68 10.68 04.72 06.72 04.72 04.72	10.76 06.76 06.76 04.72 09.76 07.76 07.76 09.76	03.2523-0811.3 03.0450-2311.2	040019 082311		Nz 23,81 Nz Reparatursatz	
	230.6 250 250 C 250 CE 280 280 C 280 CE 280 E			09.67 07.67 10.68 10.68 04.72 06.72 04.72 04.72	10.76 06.76 06.76 04.72 09.76 07.76 07.76 09.76	24.5901-0225.3	331288		L=225	

MERCEDES BENZ (W115) 200-240 D 3,0 (67-76)

	200 200 D 220 220 D 230.4 240 D 240 D 3.0			10.67 10.67 10.67 07.67 08.73 08.73 09.74	12.76 12.76 07.73 11.76 11.76 11.76 10.76	03.6850-0202.4	300043		9"	ATE	
	200 200 D 220 220 D 230.4 240 D 240 D 3.0			10.67 10.67 10.67 07.67 08.73 08.73 09.74	12.76 12.76 07.73 11.76 11.76 11.76 10.76	03.2123-1003.3	010175		Thz 23,81	ATE	
	200 200 D 220 220 D 230.4 240 D 240 D 3.0			10.67 10.67 10.67 07.67 08.73 08.73 09.74	12.76 12.76 07.73 11.76 11.76 11.76 10.76	03.3508-8753.3	310049		Behälter + WE		
	200 200 D 220 220 D 230.4 240 D 240 D 3.0			10.67 10.67 10.67 07.67 08.73 08.73 09.74	12.76 12.76 07.73 11.76 11.76 11.76 10.76	13.2571-9998.2 13.2571-9999.2 13.0441-5718.2	210133 210134 250120	 	D=57 D=57 Dichtungssatz	ATE ATE ATE	
	200 200 D 220 220 D 230.4 240 D 240 D 3.0			10.67 10.67 10.67 07.67 08.73 08.73 09.74	12.76 12.76 07.73 11.76 11.76 11.76 10.76	13.2601-9996.2 13.2601-9997.2 13.0441-6001.2	210176 210177 250126	 	D=60 D=60 Dichtungssatz	ATE ATE ATE	
	200 200 D 220 220 D 230.4 240 D 240 D 3.0			10.67 10.67 10.67 07.67 08.73 08.73 09.74	12.76 12.76 07.73 11.76 11.76 11.76 10.76	13.0460-6027.2 13.0460-0026.2 13.0460-0910.2	606027 610026 610910		20011 15,0 Belagsatz-Zubehör Belagsatz-Zubehör	ATE ATE BDX	
	200 200 D 220 220 D 230.4	097998 105289 083871 213511		10.67 10.67 10.67 07.67 08.73	12.76 12.76 07.73 11.76 11.76	13.0460-9028.2 13.0460-0027.2 13.0460-0911.2	609028 610027 610911		24.0113-0112.1	413112	273 12,6 11,0
	200 200 D 220 220 D 230.4	097999 105290 083872 213512		12.76 12.76 07.73 11.76 11.76	12.76 12.76 07.73 11.76 11.76	24.0113-0113.1	413113				274 12,6 11,0

¹⁾ + left hand drive / + guida a sinistra / + conduite à gauche / + volante a la izquierda





















²⁾ + ATE cylinder / + ATE - frizione idraulica / + cylindre ATE / + cilindrico de ATE

												
MERCEDES BENZ (W115) 200-240 D 3,0 (67-76)												
	240 D			08.73	11.76		24.0113-0113.1	413113	274 12,6 11,0			
	240 D 3.0			09.74	10.76		24.0113-0137.1	413137	278 12,6 10,6 +B			
	200			10.67	12.76		83.7704-0421.3	330827	2	L=420		
	200 D			10.67	12.76							
	220			10.67	07.73							
	220 D			07.67	11.76							
	230.4			08.73	11.76							
	240 D			08.73	11.76							
	240 D 3.0			09.74	10.76							
	200			10.67	12.70		13.2381-8030.2	210036	<input type="checkbox"/> Achtung: Kolbenstellung ändern ¹⁾	D=38	ATE	
	200 D			10.67	12.70		13.2381-8029.2	210035	<input type="checkbox"/> Achtung: Kolbenstellung ändern ¹⁾	D=38	ATE	
	220			10.67	12.70		13.0441-3811.2	250067		Dichtungssatz	ATE	
	220 D			07.67	12.70							
	200			01.71	12.76		13.2381-8027.2	210033	<input type="checkbox"/>	D=38	ATE	
	200 D			01.71	12.76		13.2381-8028.2	210034	<input type="checkbox"/>	D=38	ATE	
	220			01.71	07.73		13.0441-3811.2	250067		Dichtungssatz	ATE	
	220 D			01.71	11.76							
	230.4			08.73	11.76							
	240 D			08.73	11.76							
	240 D 3.0			09.74	10.76							
	200			10.67	12.76		13.0460-4036.2	604036		+ Anti-Noise-Blech ²⁾	21035 15,0	ATE
	200 D			10.67	12.76		13.0460-3804.2	603804			21035 15,0	ATE
	220			10.67	07.73		13.0460-0029.2	610029			Belagsatz-Zubehör	ATE
	220 D			07.67	11.76		13.0460-0912.2	610912			Belagsatz-Zubehör	BDX
	230.4			08.73	11.76							
	240 D			08.73	11.76							
	240 D 3.0			09.74	10.76							
	200			10.67	12.76		24.0110-0185.1	410185			279 10,0 8,3 +S +B	
	200 D			10.67	12.76							
	220			10.67	07.73							
	220 D			07.67	11.76							
	230.4			08.73	11.76							
	240 D			08.73	11.76							
	240 D 3.0			09.74	10.76							
	200			10.67	12.76		83.6204-0240.3	330718	2		L=240	
	200 D		070415	10.67								
	220		076568	10.67								
	220 D		064094	10.67								
	220 D		161007	07.67								
	200		070416	03.73			83.6204-0280.3	330732	2		L=280	
	200 D		076569	03.73								
	220		064095	03.73								
	220 D		161008	03.73								
	200			04.73	12.76		83.7704-0281.3	330804	2		L=280	
	200 D			04.73	12.76							
	220			04.73	07.73							
	220 D			04.73	11.76							
	230.4			08.73	11.76							
	240 D			08.73	11.76							
	240 D 3.0			09.74	10.76							
	200			10.67	12.76		03.0137-0128.2	650128			160 x 25	
	200 D			10.67	12.76		03.0137-0171.2	650171			160 x 25 /Zub	
	220			10.67	07.73		03.0137-9002.2	669002			Bremsbacken-Zubehör	
	220 D			07.67	11.76							
	230.4			08.73	11.76							
	240 D			08.73	11.76							
	240 D 3.0			09.74	10.76							
	200			313548	04.73		24.3727-0406.2	580406	1 		L=1696	
	200 D			352054	04.73		24.3727-0407.2	580407	2 		L=1488	
	220			128734	04.73							
	220 D			467453	04.73							
	230.4			087765	08.73							
	240 D			130095	08.73							
	240 D 3.0			053690	09.74							
	200			10.67	12.76		24.2419-0937.3	030063		+ ATE-Zylinder ³⁾	Gz 19,05	FTE
	200 D			10.67	12.76		03.3508-1706.3	310024			Behälter	ATE
	220			10.67	07.73		03.0350-1926.2	071926			Gz Reparatursatz	
	220 D			07.67	11.76							
	230.4			08.73	11.76							
	240 D			08.73	11.76							
	240 D 3.0			09.74	10.76							
	200			10.67	12.76		03.2523-0811.3	040019			Nz 23,81	
	200 D			10.67	12.76		03.0450-2311.2	082311			Nz Reparatursatz	
	220			10.67	07.73							
	220 D			07.67	11.76							
	230.4			08.73	11.76							
	240 D			08.73	11.76							
	240 D 3.0			09.74	10.76							
	200			10.67	12.76		24.5901-0225.3	331288			L=225	
	200 D			10.67	12.76							
	220			10.67	07.73							
	220 D			07.67	11.76							
	230.4			08.73	11.76							
	240 D			08.73	11.76							
	240 D 3.0			09.74	10.76							









































¹⁾ attn.:change piston position / att.cambiare posizione pistone / montage devant l'essieu / instalación delante del eje

²⁾ + shim / + lamierino antirumore / + tôle anti-bruit / + placa anti-ruidos

³⁾ + ATE cylinder / + ATE - frizione idraulica / + cylindre ATE / + cilindrico de ATE











									
MERCEDES BENZ (W116) 280 S-450 SEL 6,9 (72-80)									
	280 S 280 SE 280 SEL 350 SE 350 SEL 450 SE 450 SEL 450 SEL 6.9			09.72 07.80 08.72 07.80 01.74 04.80 09.72 03.80 11.73 01.80 11.72 04.80 03.73 09.80 05.75 09.80		03.6855-1202.4	300056		9" Tandem ATE
	280 S 280 SE 280 SEL 350 SE 350 SEL 450 SE 450 SEL		053429 052606 052606 029951 029951 043630 043630	09.72 08.72 01.74 09.72 11.73 11.72 03.73		03.2123-1003.3	010175		Thz 23,81 ATE
	280 S 280 SE 280 SEL 350 SE 350 SEL 450 SE 450 SEL 450 SEL 6.9	053430 052607 052607 029952 029952 043631 043631		07.80 07.80 04.80 03.80 01.80 04.80 09.80 05.75 09.80		03.2023-0166.3	010015		Thz 23,81/19,05 ATE
	280 S 280 SE 280 SEL 350 SE 350 SEL 450 SE 450 SEL 450 SEL 6.9			09.72 07.75 08.72 07.75 01.74 07.75 09.72 07.75 11.73 07.75 11.72 07.75 03.73 07.75 05.75 07.75		03.3508-8753.3	310049		Behälter + WE
	280 S 280 SE 280 SEL 350 SE 350 SEL 450 SE 450 SEL 450 SEL 6.9			09.72 07.80 08.72 07.80 01.74 04.80 09.72 03.80 11.73 01.80 11.72 04.80 03.73 09.80 05.75 09.80		24.9260-8025.5 24.9260-8026.5 13.0441-6001.2	230041 230042 250126	<input type="checkbox"/> <input type="checkbox"/>	D=60 D=60 Dichtungssatz ATE ATE ATE
	280 S 280 SE 280 SEL 350 SE 350 SEL 450 SE 450 SEL 450 SEL 6.9			09.72 07.80 08.72 07.80 01.74 04.80 09.72 03.80 11.73 01.80 11.72 04.80 03.73 09.80 05.75 09.80		13.0460-9028.2 24.8190-0401.2	609028 620401	4	20392 15,0 /WE Warnkontakt L=95mm ATE
	280 S 280 SE 280 SEL 350 SE 350 SEL 450 SE 450 SEL 450 SEL 6.9			09.72 07.80 08.72 07.80 01.74 04.80 09.72 03.80 11.73 01.80 11.72 04.80 03.73 09.80 05.75 09.80		24.0122-0106.1	422106		278 22,0 20,0 V L
	280 S 280 SE 280 SEL 350 SE 350 SEL 450 SE 450 SEL 450 SEL 6.9			09.72 07.80 08.72 07.80 01.74 04.80 09.72 03.80 11.73 01.80 11.72 04.80 03.73 09.80 05.75 09.80		83.7704-0421.3	330827	2	L=420
	280 S 280 SE 280 SEL 350 SE 350 SEL 450 SE 450 SEL 450 SEL 6.9			09.72 07.80 08.72 07.80 01.74 04.80 09.72 03.80 11.73 01.80 11.72 04.80 03.73 09.80 05.75 09.80		13.2381-8027.2 13.2381-8028.2 13.0441-3811.2	210033 210034 250067	<input type="checkbox"/> <input type="checkbox"/>	D=38 D=38 Dichtungssatz ATE ATE ATE
	280 S 280 SE 280 SEL 350 SE 350 SEL 450 SE 450 SEL 450 SEL 6.9			09.72 07.80 08.72 07.80 01.74 04.80 09.72 03.80 11.73 01.80 11.72 04.80 03.73 09.80 05.75 09.80		13.2381-8029.2 13.2381-8030.2 13.0441-3811.2	210035 210036 250067	<input type="checkbox"/> <input type="checkbox"/>	D=38 D=38 Dichtungssatz ATE ATE ATE
	280 S 280 SE 280 SEL 350 SE 350 SEL 450 SE 450 SEL 450 SEL 6.9			09.72 07.80 08.72 07.80 01.74 04.80 09.72 03.80 11.73 01.80 11.72 04.80 03.73 09.80 05.75 09.80		13.0460-4036.2 13.0460-3804.2 13.0460-0029.2 13.0460-0912.2	604036 603804 610029 610912	+ Anti-Noise-Blech 1)	21035 15,0 21035 15,0 Belagsatz-Zubehör Belagsatz-Zubehör ATE ATE ATE BDX
	280 S 280 SE 280 SEL 350 SE 350 SEL 450 SE 450 SEL			09.72 07.80 08.72 07.80 01.74 04.80 09.72 03.80 11.73 01.80 11.72 04.80 03.73 09.80		24.0110-0185.1	410185		279 10,0 8,3 +S +B

1) + shim / + lamierino antirumore / + tôle anti-bruit / + placa anti-ruidos

								
MERCEDES BENZ (W116) 280 S-450 SEL 6,9 (72-80)								
	450 SEL 6.9		05.75	09.80	24.0110-0185.1	410185		279 10,0 8,3 +S +B
	280 S 280 SE 350 SE 450 SE		09.72 08.72 09.72 11.72	03.73 03.73 03.73 03.73	83.6204-0282.3	330309	2	L=280
	280 S 280 SE 280 SEL 350 SE 350 SEL 450 SE 450 SEL 450 SEL 6.9		04.73 04.73 01.74 04.73 11.73 04.73 03.73 05.75	07.80 07.80 04.80 03.80 01.80 04.80 09.80 09.80	83.7704-0281.3	330804	2	L=280
	280 S 280 SE 280 SEL 350 SE 350 SEL 450 SE 450 SEL 450 SEL 6.9		09.72 08.72 01.74 09.72 11.73 11.72 03.73 05.75	07.80 07.80 04.80 03.80 01.80 04.80 09.80 09.80	03.0137-0128.2 03.0137-0171.2 03.0137-9002.2	650128 650171 669002		160 x 25 160 x 25 /Zub Bremsbacken-Zubehör
	280 S 280 SE 280 SEL 350 SE 350 SEL	◀ ◀ ◀ ◀ ◀	09.72 08.72 01.74 09.72 11.73	07.80 07.80 04.80 03.80 01.80	24.2419-0937.3 03.0350-1926.2	030063 071926	+ ATE-Zylinder 1)	Gz 19,05 Gz Reparatursatz FTE ATE
	280 S 280 SE 280 SEL		09.72 08.72 01.74	07.80 07.80 04.80	03.2523-0811.3 03.0450-2311.2	040019 082311		Nz 23,81 Nz Reparatursatz
	350 SE 350 SEL		09.72 11.73	03.80 01.80	24.5901-0225.3	331288		L=225
MERCEDES BENZ (W120) 180 b,c,Db,Dc (59-62)								
	180 b. c. Db. Dc		01.59	12.62	03.3126-0505.3	010294	+ Bremsgerät 2)	Hz 26,99 ATE
	180 b. c. Db. Dc		01.59	12.62	03.3508-3600.3	310030		Behälter
	180 b. c. Db. Dc		01.59	12.62	83.7704-0320.3	330851	2 (83.5104-0320.3)	L=320
	180 b. c. Db. Dc		01.59	12.62	03.2728-2101.3 03.2728-2201.3 03.0402-1128.2	020008 020009 060027	  	Rz 28,57 Rz 28,57 Rz Reparatursatz
	180 b. c. Db. Dc		01.59	12.62	83.6104-0210.3 83.6204-0220.3	330473 330308	 	L=210 L=220
	180 b. c. Db. Dc		01.59	12.62	03.3223-0102.3	020090		Rz 23,81
MERCEDES BENZ (W121) 190 b,Db (59-61)								
	190 b. Db		01.59	12.61	03.3126-0505.3	010294	+ Bremsgerät 2)	Hz 26,99 ATE
	190 b. Db		01.59	12.61	03.3508-3600.3	310030		Behälter
	190 b. Db		01.59	12.61	83.7704-0320.3	330851	2 (83.5104-0320.3)	L=320
	190 b. Db		01.59	12.61	03.2728-2101.3 03.2728-2201.3 03.0402-1128.2	020008 020009 060027	  	Rz 28,57 Rz 28,57 Rz Reparatursatz
	190 b. Db		01.59	12.61	83.6104-0210.3 83.6204-0220.3	330473 330308	 	L=210 L=220
	190 b. Db		01.59	12.61	03.3223-0102.3	020090		Rz 23,81
MERCEDES BENZ (W121) 190 SL (55-60)								
	190 SL		01.55	12.60	03.3126-0505.3	010294		Hz 26,99 ATE
	190 SL		01.55	12.60	83.7704-0320.3	330851	2 	L=320













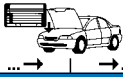

1) + ATE cylinder / + ATE - frizione idraulica / + cylindre ATE / + cilindrico de ATE

2) + booster unit / + servofreno / + servo-frein / + servofreno

MERCEDES BENZ (W121) 190 SL (55-60)														
	190 SL			01.55	12.60			03.2728-2101.3	020008				Rz 28,57	
								03.2728-2201.3	020009				Rz 28,57	
								03.0402-1128.2	060027				Rz Reparatursatz	
	190 SL			01.55	12.60			83.6104-0210.3	330473				L=210	
								83.6204-0220.3	330308				L=220	
	190 SL			01.55	12.60			03.3223-0102.3	020090				Rz 23,81	
MERCEDES BENZ (W123) 200-300 TD Turbo (76-85)														
	200		093032	01.76				03.6850-0202.4	300043				9"	ATE
	200 D		164440	01.76										
	220 D			01.76	01.79									
	230		112975	01.76										
	230 C		008670	03.77										
	230 T		001048	04.78										
	240 D		092734	01.76										
	240 TD		001423	02.78										
	250		057387	01.76										
	250 T		000765	04.78										
	280		024581	01.76										
	280 C		002609	03.77										
	280 CE		011831	03.77										
	280 E		046827	01.76										
	280 TE		000620	02.78										
	300 D		116225	01.76										
	300 TD		001361	04.78										
	230			12.85	+ Spezialaufbau ¹⁾			03.6855-1202.4	300056				9" Tandem	ATE
	230 E			12.85	+ Spezialaufbau ¹⁾									
	240 D			12.85	+ Spezialaufbau ¹⁾									
	240 D			12.85	+ langer Radstand ²⁾									
	250			12.85	+ langer Radstand ²⁾									
	280 E			12.85	+ langer Radstand ²⁾									
	300 D			12.85	+ langer Radstand ²⁾									
	200			01.76	09.85			03.2023-0166.3	010015				Thz 23,81/19,05	ATE
	200 D			01.76	03.85									
	200 T			11.80	12.85									
	220 D			01.76	01.79									
	230			01.76	02.81									
	230 C			03.77	04.80									
	230 CE			06.80	07.85									
	230 E			06.80	09.85									
	230 T			04.78	04.80									
	230 TE			06.80	12.85									
	240 D			01.76	07.85									
	240 TD			02.78	12.85									
	250			01.76	07.85									
	250 T			04.78	08.82									
	280			01.76	07.81									
	280 C			03.77	03.80									
	280 CE			03.77	07.85									
	280 E			01.76	09.85									
	280 TE			04.78	12.85									
	300 D			01.76	07.85									
	300 TD			04.78	12.85									
	300 TD Turbo			08.80	12.85									
	230			01.76	12.85	+ Spezialaufbau ¹⁾		03.2023-0166.3	010015				Thz 23,81/19,05	ATE
	230 E		173999	06.80	+ Spezialaufbau ¹⁾									
	240 D		414568	01.76	+ Spezialaufbau ¹⁾									
	240 D		414568	01.76	+ langer Radstand ²⁾									
	250		118041	01.76	+ langer Radstand ²⁾									
	280 E		115175	01.76	+ langer Radstand ²⁾									
	300 D		310479	01.76	+ langer Radstand ²⁾									
	230 E	174000		12.85	+ Spezialaufbau ¹⁾			03.2025-0111.3	010033				Thz 25,40/19,05	ATE
	240 D	414569		12.85	+ Spezialaufbau ¹⁾									
	240 D	414569		12.85	+ langer Radstand ²⁾									
	250	118042		12.85	+ langer Radstand ²⁾									
	280 E	115176		12.85	+ langer Radstand ²⁾									
	300 D	310480		12.85	+ langer Radstand ²⁾									
	200			01.76	09.85			24.9260-8029.5	230043				D=60	ATE
	200	69		01.76	09.85			24.9260-8030.5	230044				D=60	ATE
	200 D			01.76	03.85			13.0441-6003.2	250128				Dichtungssatz	ATE
	200 T			11.80	12.85									
	220 D			01.76	01.79									
	230			01.76	02.81									
	230 C			03.77	04.80									
	230 CE			06.80	07.85									
	230 E			06.80	09.85									
	230 T			04.78	04.80									
	230 TE			06.80	12.85									
	240 D			01.76	07.85									
	240 TD			02.78	12.85									
	250			01.76	07.85									
	250 T			04.78	08.82									
	280			01.76	07.81									

¹⁾ + special body / + carrozzeria speciale / + carrosserie spéciale / + construcc.carrocería especial

²⁾ + long wheel base / + passo lungo / + empattement long / + distancia larga entre ejes

								
MERCEDES BENZ (W123) 200-300 TD Turbo (76-85)								
				03.77 03.80 03.77 07.85 01.76 09.85 04.78 12.85 01.76 07.85 04.78 12.85 08.80 12.85	24.9260-8029.5 230043 24.9260-8030.5 230044 13.0441-6003.2 250128			D=60 ATE D=60 ATE Dichtungssatz ATE
	69			01.76 07.79 01.76 07.79 01.76 07.79 01.76 07.79 01.76 07.79 03.77 07.79 04.78 07.79 01.76 07.79 02.78 07.79 01.76 07.79 04.78 07.79 01.76 07.79 03.77 07.79 03.77 07.79 01.76 07.79 04.78 07.79 01.76 07.79 04.78 07.79 01.76 07.79 04.78 07.79	13.0460-9028.2 609028 13.0460-0027.2 610027 13.0460-0911.2 610911 24.8190-0401.2 620401	4		20392 15,0 /WE ATE Belagsatz-Zubehör ATE Belagsatz-Zubehör BDX Warnkontakt L=95mm
	69			08.79 09.85 08.79 09.85 08.79 03.85 11.80 12.85 08.79 02.81 08.79 04.80 06.80 07.85 06.80 09.85 08.79 04.80 06.80 12.85 08.79 07.85 08.79 08.82 08.79 07.81 08.79 03.80 08.79 07.85 08.79 09.85 08.79 12.85 08.79 07.85 08.79 12.85 08.80 12.85	13.0460-9029.2 609029 13.0460-0131.2 610131 24.8190-0401.2 620401	4		20341 16,7 /WE ATE Belagsatz-Zubehör ATE Warnkontakt L=95mm
	69			01.76 09.85 01.76 09.85 01.76 03.85 11.80 12.85 01.76 01.79 01.76 02.81 03.77 04.80 06.80 07.85 06.80 09.85 04.78 04.80 06.80 12.85 01.76 07.85 02.78 12.85 01.76 07.85 04.78 08.82 01.76 07.81 03.77 03.80 03.77 07.85 01.76 09.85 04.78 12.85 01.76 07.85 04.78 12.85 08.80 12.85	24.0113-0137.1 413137			278 12,6 10,6 +B
	69	126115 126115 179856 158355 015330 004326 150314 007370 079228 003285 027813 003416 017058 064176 004195 165147	01.76 01.76 01.76 01.76 03.77 04.78 01.76 02.78 01.76 04.78 03.77 01.76 03.77 03.77 01.76 04.78 01.76 03.77 03.77 01.76 04.78 01.76	83.6104-0360.3 330475	2		L=360	
↓								

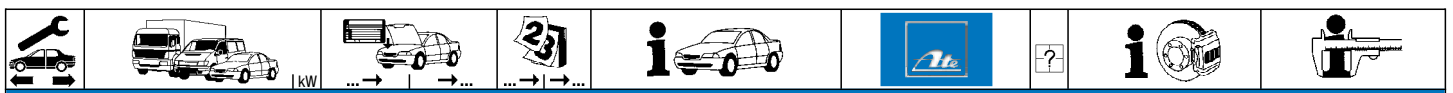

MERCEDES BENZ (W123) 200-300 TD Turbo (76-85)

300 TD		011092	04.78		83.6104-0360.3	330475	2		L=360	
200	126116		09.85		24.5101-0346.3	331406	2		L=346	
200	69 126116		09.85							
200 D	179857		03.85							
200 T			11.80	12.85						
230	158356		02.81							
230 C	015331		02.81							
230 CE			06.80	07.85						
230 E			06.80	09.85						
230 T	004327			04.80						
230 TE			06.80	12.85						
240 D	150315			07.85						
240 TD	007371			12.85						
250	079229			07.85						
250 T	003286			08.82						
280	027814			07.81						
280 C	003417			03.80						
280 CE	017059			07.85						
280 E	064177			09.85						
280 TE	004196			12.85						
300 D	165148			07.85						
300 TD	011093			12.85						
300 TD Turbo			08.80	12.85						
200	69		01.76	09.85	13.2381-8027.2	210033	☐		D=38	ATE
200			01.76	09.85	13.2381-8028.2	210034	☐		D=38	ATE
200 D			01.76	03.85	13.0441-3811.2	250067	☐		Dichtungssatz	ATE
220 D			01.76	01.79						
230			01.76	02.81						
230 C			03.77	04.80						
230 CE			06.80	07.85						
230 E			06.80	09.85						
240 D			01.76	07.85						
250			01.76	07.85						
280			01.76	07.81						
280 C			03.77	03.80						
280 CE			03.77	07.85						
280 E			01.76	09.85						
300 D			01.76	07.85						
200 T			11.80	12.85	13.2421-8021.2	210057	☐		D=42	ATE
230 T			04.78	04.80	13.2421-8022.2	210058	☐		D=42	ATE
230 TE			06.80	12.85	24.9242-8021.5	230031	☐		D=42	ATE
240 TD			02.78	12.85	24.9242-8022.5	230032	☐		D=42	ATE
250 T			04.78	08.82	13.0441-4206.2	250087	☐		Dichtungssatz	ATE
280 TE			04.78	12.85						
300 TD			04.78	12.85						
300 TD Turbo			08.80	12.85						
200	69		01.76	09.85	13.0460-4036.2	604036		+ Anti-Noise-Blech 1)	21035 15,0	ATE
200			01.76	09.85	13.0460-3804.2	603804			21035 15,0	ATE
200 D			01.76	03.85	13.0460-0029.2	610029			Belagsatz-Zubehör	ATE
220 D			01.76	01.79	13.0460-0912.2	610912			Belagsatz-Zubehör	BDX
230			01.76	02.81						
230 C			03.77	04.80						
230 CE			06.80	07.85						
230 E			06.80	09.85						
240 D			01.76	07.85						
250			01.76	07.85						
280			01.76	07.81						
280 C			03.77	03.80						
280 CE			03.77	07.85						
280 E			01.76	09.85						
300 D			01.76	07.85						
200 T			11.80	12.85	13.0460-3804.2	603804			21035 15,0	ATE
230 T			04.78	04.80	13.0460-0029.2	610029			Belagsatz-Zubehör	ATE
230 TE			06.80	12.85	13.0460-0912.2	610912			Belagsatz-Zubehör	BDX
240 TD			02.78	12.85						
250 T			04.78	08.82						
280 TE			04.78	12.85						
300 TD			04.78	12.85						
300 TD Turbo			08.80	12.85						
200	69		01.76	09.85	24.0110-0185.1	410185			279 10,0 8,3 +S +B	
200			01.76	09.85						
200 D			01.76	03.85						
200 T			11.80	12.85						
220 D			01.76	01.79						
230			01.76	02.81						
230 C			03.77	04.80						
230 CE			06.80	07.85						
230 E			06.80	09.85						
230 T			04.78	04.80						
230 TE			06.80	12.85						
240 D			01.76	07.85						
240 TD			02.78	12.85						
250			01.76	07.85						
250 T			04.78	08.82						
280			01.76	07.81						
280 C			03.77	03.80						

1) + shim / + lamierino antirumore / + tôle anti-bruit / + placa anti-ruídos



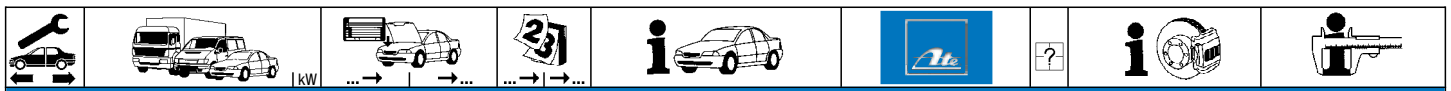

MERCEDES BENZ (W123) 200-300 TD Turbo (76-85)

	280 CE 280 E 280 TE 300 D 300 TD 300 TD Turbo			03.77 07.85 01.76 09.85 04.78 12.85 01.76 07.85 04.78 12.85 08.80 12.85	24.0110-0185.1	410185		279 10,0 8,3 +S +B
	200 200 200 D 200 T 220 D 230 230 C 230 CE 230 E 230 T 230 TE 240 D 240 TD 250 250 T 280 280 C 280 CE 280 E 280 TE 300 D 300 TD 300 TD Turbo	69		01.76 09.85 01.76 07.95 01.76 03.85 11.80 12.85 01.76 01.79 01.76 02.81 03.77 04.80 06.80 07.85 06.80 09.85 04.78 04.80 06.80 12.85 01.76 07.85 02.78 12.85 01.76 07.85 04.78 08.82 01.76 07.81 03.77 03.80 03.77 07.85 01.76 09.85 04.78 12.85 01.76 07.85 04.78 12.85 08.80 12.85	83.7704-0281.3	330804	2	L=280
	200 200 200 D 200 T 220 D 230 230 C 230 CE 230 E 230 T 230 TE 240 D 240 TD 250 250 T 280 280 C 280 CE 280 E 280 TE 300 D 300 TD 300 TD Turbo	69		01.76 09.85 01.76 09.85 01.76 03.85 11.80 12.85 01.76 01.79 01.76 02.81 03.77 04.80 06.80 07.85 06.80 09.85 04.78 04.80 06.80 12.85 01.76 07.85 02.78 12.85 01.76 07.85 04.78 08.82 01.76 07.81 03.77 03.80 03.77 07.85 01.76 09.85 04.78 12.85 01.76 07.85 04.78 12.85 08.80 12.85	03.0137-0128.2 03.0137-0171.2 03.0137-9002.2	650128 650171 669002		160 x 25 160 x 25 /Zub Bremsbacken-Zubehör
	200 200 200 D 200 T 220 D 230 230 E 230 T 230 TE 240 D 240 TD 250 250 T 280 280 E 280 TE 300 D 300 TD 300 TD Turbo	69		01.76 09.85 01.76 07.85 01.76 03.85 11.80 12.85 01.76 01.79 01.76 02.81 06.80 09.85 04.78 04.80 06.80 12.85 01.76 07.85 02.78 12.85 01.76 07.85 04.78 08.82 01.76 07.81 01.76 09.85 04.78 12.85 01.76 07.85 04.78 12.85 08.80 12.85	24.3727-0403.2 24.3727-0401.2 24.3727-0402.2	580403 580401 580402	1 + Linkstenker ¹⁾ <input type="checkbox"/> <input type="checkbox"/>	L=1738 L=1640 L=1616
	230 C 230 CE 280 C 280 CE			03.77 04.80 06.80 07.85 03.77 03.80 03.77 07.85	24.3727-0401.2 24.3727-0402.2	580401 580402	<input type="checkbox"/> <input type="checkbox"/>	L=1640 L=1616
	200 200 200 D 200 T 220 D 230 230 C 230 CE 230 E 230 T 230 TE 240 D 240 D	69	091118 091118 091118 015866 091118 091118 091118 091118 091118 015866 015866 091118	01.76 01.76 01.76 11.80 01.76 01.76 03.77 06.80 06.80 04.78 06.80 01.76	24.2419-0901.3	030041		Gz 19,05

¹⁾ + left hand drive / + guida a sinistra / + conduite à gauche / + volante a la izquierda



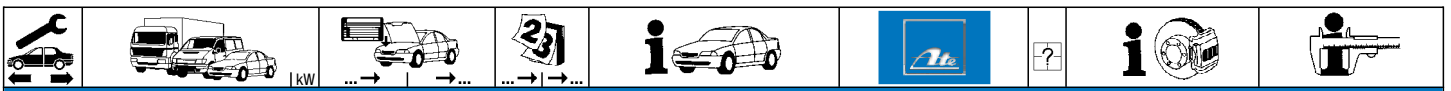

MERCEDES BENZ (W123) 200-300 TD Turbo (76-85)

	240 TD 250 250 T 280 280 C 280 CE 280 E 280 TE 300 D 300 TD 300 TD Turbo		015866 091118 015866 091118 091118 091118 091118 015866 091118 015866	02.78 01.76 04.78 01.76 03.77 03.77 01.76 04.78 01.76 04.78		24.2419-0901.3	030041		Gz 19,05
	200 200 200 D 200 T 220 D 230 230 C 230 CE 230 E 230 T 230 TE 240 D 240 TD 250 250 T 280 280 C 280 CE 280 E 280 TE 300 D 300 TD 300 TD Turbo	091119 69 091119 091119 015867 091119 091119 091119 091119 091119 015867 015867 091119 015867 091119 091119 015867 091119 091119 091119 091119 015867 091119 015867 015867		09.85 09.85 03.85 12.85 01.79 02.81 04.80 07.85 09.85 04.80 12.85 07.85 12.85 07.85 08.82 07.81 03.80 07.85 09.85 12.85 07.85 12.85 12.85		24.2419-0936.3	030062		Gz 19,05
	200 200 D 220 D 230 230 C 230 T 240 D 240 TD 280 280 C 280 CE 300 D 300 TD	69	238053 219674 014172	01.76 01.76 01.76 01.76 03.77 04.78 01.76 02.78 01.76 03.77 01.76 04.78	08.80 01.79 02.81 04.80 04.80 01.76 07.81 03.80 07.85 12.85	03.2523-0811.3 03.0450-2311.2	040019 082311		Nz 23,81 Nz Reparatursatz
	200 200 D 200 T 230 CE 230 E 230 TE 240 D 240 TD	80	238054 219675 014173	03.80 11.80 06.80 06.80 06.80	09.85 03.85 12.85 07.85 09.85 12.85 07.85 12.85	03.2523-1210.3	040021		Nz 23,81
	200 200 200 D 200 T 220 D 230 230 C 230 CE 230 E 230 T 230 TE 240 D 240 TD 250 250 T 280 280 C 280 CE 280 E 280 TE 300 D 300 TD 300 TD Turbo	69		01.76 01.76 01.76 11.80 01.76 01.76 03.77 06.80 06.80 04.78 06.80 02.78 01.76 04.78 01.76 01.76 03.77 03.77 01.76 04.78 01.76 04.78 08.80	09.85 09.85 03.85 12.85 01.79 02.81 04.80 07.85 09.85 04.80 12.85 07.85 07.85 08.82 07.81 03.80 07.85 09.85 12.85 07.85 12.85 12.85	24.5901-0225.3	331288		L=225

MERCEDES BENZ (W124) E-Klasse (85-93)

	230 E Kombi 230 E Kombi 250 D Kombi 250 D Kombi 260 E Kombi 300 CE 24 Cabrio alle Typen Coupe alle Typen Kombi		F163537 F161233 F163537 F161233 F161233	10.85 10.85 10.85 10.85 10.85	+ Spezialaufbau/Radstand 2800mm ¹⁾ + Spezialaufbau/Radstand 3450mm ²⁾ + Spezialaufbau/Radstand 2800mm ¹⁾ + Spezialaufbau/Radstand 3450mm ²⁾ + Spezialaufbau/Radstand 3450mm ²⁾	03.7760-2702.4	300090		10" ATE
↓				01.92 05.87 10.85	06.93 06.93 06.93				

¹⁾ + special body/wheel base 2800mm / + carrozz. spec./ passo 2800mm / + carross.spéc./ empatt. 2800mm / + con.carr.esp./ dist.ejes 2800mm
²⁾ + special body/wheel base 3450mm / + carrozz. spec./ passo 3450mm / + carross.spéc./ empatt. 3450mm / + con.carr.esp./ dist.ejes 3450mm

MERCEDES BENZ (W124) E-Klasse (85-93)

	alle Typen Lim.			01.85	06.93	+ 4 türig/ - 400 E/ - 500 E ¹⁾	03.7760-2702.4	300090		10"	ATE		
	250 D			01.90	06.93	+ 6 türig ²⁾	03.2023-0825.3	010028		Thz 23,81/19,05	ATE		
	260 E			01.90	09.92	+ 6 türig ²⁾							
	280 E			10.92	06.93	+ 6 türig ²⁾							
	300 CE 24 Cabrio			01.92	06.93								
	alle Typen Coupe			05.87	06.93								
	alle Typen Kombi			10.85	06.93								
	alle Typen Lim.			01.85	06.93	+ 4 türig/ - 400 E/ - 500 E ¹⁾							
	250 D			01.90	06.93	+ 6 türig ²⁾	03.2023-0230.3	010019		Thz 23,81/19,05	ATE		
	260 E			01.90	09.92	+ 6 türig ²⁾							
	280 E			10.92	06.93	+ 6 türig ²⁾							
	400 E			10.92	06.93		03.2025-0211.3	010034		Thz 25,40/19,05	ATE		
	500 E		B927760	01.91									
	200			01.85	02.90		24.3541-1725.5	240003		D=54, - Halter D=54, - Halter Dichtungssatz Faltenbalgatz	LUC		
	200 CE			04.90	09.92		24.3541-1726.5	240004			LUC		
	200 D			01.85	06.93		11.0441-5404.2	250029			LUC		
	200 E			01.85	09.92		11.0101-5403.2	260010			LUC		
	200 T			10.85	02.90								
	200 TD			10.85	08.91								
	200 TE			10.88	09.92								
	230 CE			05.87									
	230 E	A323451	A797178										
	230 E		A805931										
	230 E		A279007		01.85								
	230 E Kombi		F081909		01.85	+ Spezialaufbau ³⁾							
	230 TE		F081909		10.85								
	250 D				01.85	06.93	+ 4 türig ⁴⁾						
	250 D Kombi				10.85	06.93	+ Spezialaufbau ³⁾						
	250 TD				10.85	06.93							
	300 D				01.85	06.93							
	300 TD				04.86	06.93							
	200 CE				10.92	06.93		24.3541-1603.5	240037			D=54, - Halter D=54, - Halter Bremsattel-Zubehör	LUC
	200 E				10.92	06.93		24.3541-1604.5	240038				LUC
	200 TE				10.92	06.93		24.0101-3601.2	260044				LUC
	220 CE				10.92	06.93							
	220 E				10.92	06.93							
	220 TE				10.92	06.93							
	230 CE	A797179	A323450		09.92								
	230 E	A279008											
230 E	A805932			09.92									
230 E Kombi	F081910			09.92	+ Spezialaufbau ³⁾								
230 TE	F081910			09.92									
250 D				01.90	06.93	+ 6 türig ²⁾							
250 D Turbo				09.88	06.93								
250 TD Turbo				04.90	06.93	+ 1							
260 E				01.85	09.92	+ 4 türig ⁴⁾							
260 E				01.90	09.92	+ 6 türig ²⁾							
260 E Kombi				10.85	09.92	+ Spezialaufbau ³⁾							
280 E				10.92	06.93	+ Radstand 2800mm ⁵⁾							
280 TE				10.92	06.93								
300 CE				05.87	09.92								
300 D Turbo				09.87	06.93								
300 E				01.85	09.92								
300 TD Turbo				10.85	06.93								
300 TE				10.85	09.92								
280 E		B884946		10.92		+ Radstand 3600mm ⁶⁾	13.0441-4214.2	250091		Dichtungssatz	ATE		
280 E Kombi		F242721		10.92		+ Spezialaufbau ³⁾							
300 CE 24 Cabrio				01.92	06.93								
300 CE 24 Coupe				09.89	09.92								
300 E 24				09.89	09.92								
300 TE 24				09.89	09.92								
320 CE		B862121		10.92									
320 E		B864307		10.92									
320 TE		F242721		10.92									
280 E	B884947				06.93	+ Radstand 3600mm ⁶⁾	13.0441-4214.2	250091		Dichtungssatz	ATE		
280 E Kombi	F242722				06.93	+ Spezialaufbau ³⁾							
320 CE	B862122				06.93								
320 E	B864308				06.93								
320 TE	F242722				06.93								
400 E		B938568		10.92									
500 E		B927760		01.91			24.9442-8003.5	230053		D=42/38	ATE		
							24.9442-8004.5	230054		D=42/38	ATE		
400 E	B938569				06.93		13.0441-4214.2	250091		Dichtungssatz	ATE		
500 E	B927761				06.93								
	200			01.85	02.90		13.0460-2927.2	602927	2	20941 19,3 /WE/S 20941 19,3 /WE/S Warmkontakt L=68(150)mm	LUC		
	200 CE			04.90	06.93		13.0470-2927.2	LD2927				LUC	
	200 D			01.85	06.93		24.8190-0402.2	620402					
	200 E			01.85	06.93								
	220 CE			10.92	06.93								
	220 E			10.92	06.93								
	230 CE			05.87	09.92								
	230 E			01.85	09.92								
	250 D			01.85	06.93								
	250 D Turbo			09.88	06.93								
260 E			01.85	09.92									

¹⁾ + 4 door/ - 400 E/ - 500 E / + 4 porte/ - 400 E/ - 500 E / + 4 portes/ - 400 E/ - 500 E / + 4 puertas/ - 400 E/ - 500 E

²⁾ + 6 door / + 6 porte / + 6 portes / + 6 puertas

³⁾ + special body / + carrozzeria speciale / + carrosserie spéciale / + construcc.carrocería especial

⁴⁾ + 4 door / + 4 porte / + 4 portes / + 4 puertas

⁵⁾ + wheel base 2800 mm / + passo 2800 mm / + empattement 2800 mm / + distancia entre ejes 2800 mm

⁶⁾ + wheel base 3600 mm / + passo 3600 mm / + empattement 3600 mm / + distancia entre ejes 3600 mm



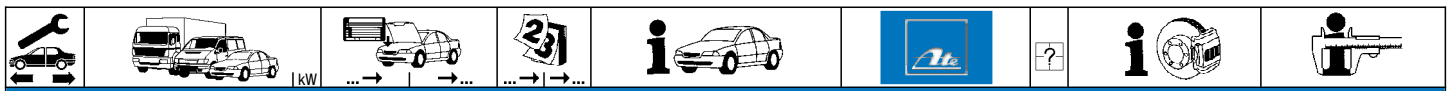

MERCEDES BENZ (W124) E-Klasse (85-93)

	260 E 4-Matic			05.85	08.91		13.0460-2927.2	602927	2	20941 19,3 /WE/S 20941 19,3 /WE/S Warnkontakt L=68(150)mm	LUC LUC
	280 E			10.92	06.93	+ Radstand 2800mm ¹⁾	13.0470-2927.2	LD2927			
	300 CE			05.87	09.92		24.8190-0402.2	620402			
	300 D			01.85	06.93						
	300 D 4-Matic			12.86	08.91						
	300 D Turbo			09.87	06.93						
	300 D Turbo 4-Matic			09.87	06.93						
	300 E			01.85	09.92						
	300 E 4-Matic			11.86	06.93						
	200 T			10.85	02.90		13.0460-2927.2	602927			
200 TD			10.85	08.91		13.0470-2927.2	LD2927				
200 TE			10.88	06.93		24.8190-0402.2	620402				
220 TE			10.92	06.93							
230 E Kombi			01.85	09.92	+ Spezialaufbau ²⁾						
230 TE			10.85	09.92							
250 D Kombi			10.85	06.93	+ Spezialaufbau ²⁾						
250 TD			10.85	06.93							
250 TD Turbo			04.90	06.93	+ ⊕						
260 E Kombi			10.85	09.92	+ Spezialaufbau ²⁾						
280 TE			10.92	06.93							
300 TD			04.86	06.93							
300 TD Turbo			10.85	06.93							
300 TD Turbo 4-Matic			03.87	06.93							
300 TE			10.85	09.92							
300 TE 4-Matic			11.86	06.93							
280 E		B884946	10.92		+ Radstand 3600mm ³⁾	13.0460-4201.2	604201	4	21153 17,5 /WE Belagsatz-Zubehör Warnkontakt L=95mm	ATE ATE	
280 E Kombi		F242721	10.92		+ Spezialaufbau ²⁾	13.0460-0219.2	610219				
300 CE 24 Cabrio			01.92	06.93		24.8190-0401.2	620401				
300 CE 24 Coupe			09.89	09.92							
300 E 24			09.89	09.92							
300 TE 24			09.89	09.92							
320 CE		B862121	10.92								
320 E		B864307	10.92								
320 TE		F242721	10.92								
400 E	B938569			06.93							
500 E			01.91	06.93							
280 E	B884947			06.93	+ Radstand 3600mm ³⁾	13.0460-4202.2	604202	4	21153 16,0 /WE Belagsatz-Zubehör Warnkontakt L=95mm	ATE	
280 E Kombi	F242722			06.93	+ Spezialaufbau ²⁾	13.0460-0268.2	610268				
320 CE	B862122			06.93		24.8190-0401.2	620401				
320 E	B864308			06.93							
320 TE	F242722			06.93							
400 E		B938568	10.92								
	200			01.85	02.90		24.0112-0117.1	412117	4	284 12,0 10,0 +S +B Halterschraube	
	200 CE			04.90	09.92		13.8190-0242.1	990124			
	200 D			01.85	06.93						
	200 E			01.85	09.92						
	200 T			10.85	02.90						
	200 TD			10.85	08.91						
	200 TE			10.88	09.92						
	230 CE		A797178	05.87							
	230 E	A323451	A805931								
	230 E		A279007	01.85							
	230 E Kombi		F081909	01.85		+ Spezialaufbau ²⁾					
	230 TE		F081909	10.85							
	250 D			01.85	06.93						
	250 D Kombi			10.85	06.93	+ Spezialaufbau ²⁾					
	250 TD			10.85	06.93						
300 D			01.85	06.93							
300 TD			04.86	06.93							
200 CE			10.92	06.93		24.0122-0123.1	422123	4	284 22,0 19,4 V L +S +B Halterschraube		
200 E			10.92	06.93		13.8190-0242.1	990124				
200 TE			10.92	06.93							
220 CE			10.92	06.93							
220 E			10.92	06.93							
220 TE			10.92	06.93							
230 CE		A797179		09.92							
230 E		A279008									
230 E		A805932		09.92							
230 E Kombi		F081910		09.92	+ Spezialaufbau ²⁾						
230 TE		F081910		09.92							
250 D			01.90	06.93	+ 6 türig ⁴⁾						
250 D Turbo			09.88	06.93							
250 TD Turbo			04.90	06.93	+ ⊕						
260 E			01.85	09.92	+ 4 türig ⁵⁾						
260 E			01.90	09.92	+ 6 türig ⁴⁾						
260 E Kombi			10.85	09.92	+ Spezialaufbau ²⁾						
280 E			10.92	06.93	+ Radstand 2800mm ¹⁾						
280 TE			10.92	06.93							
300 CE			05.87	09.92							
300 D Turbo			09.87	06.93							
300 E			01.85	09.92							
300 TD Turbo			10.85	06.93							
300 TE			10.85	09.92							
260 E 4-Matic			05.85	08.91		24.0122-0134.1	422134	4	284 22,0 19,4 V L +B Halterschraube		
300 D 4-Matic			12.86	08.91		13.8190-0330.1	990134				
300 D Turbo 4-Matic			09.87	06.93							
300 E 4-Matic			11.86	06.93							

¹⁾ + wheel base 2800 mm / + passo 2800 mm / + empattement 2800 mm / + distancia entre ejes 2800 mm
²⁾ + special body / + carrozzeria speciale / + carrosserie spéciale / + construcc.carroceria especial
³⁾ + wheel base 3600 mm / + passo 3600 mm / + empattement 3600 mm / + distancia entre ejes 3600 mm
⁴⁾ + 6 door / + 6 porte / + 6 portes / + 6 puertas
⁵⁾ + 4 door / + 4 porte / + 4 portes / + 4 puertas

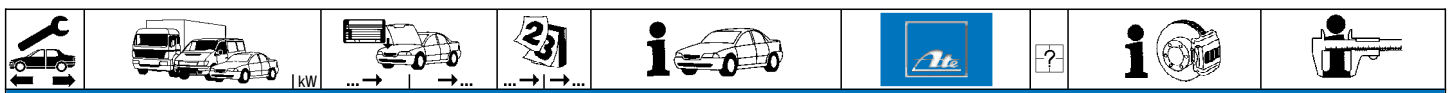

MERCEDES BENZ (W124) E-Klasse (85-93)

	300 TD Turbo 4-Matic		03.87	06.93	24.0122-0134.1	422134		284 22,0 19,4 V L +B					
	300 TE 4-Matic		11.86	06.93	13.8190-0330.1	990134	4	Halterschraube					
	280 E	B884946	10.92	06.93	24.0122-0136.1	422136	4	295 22,0 19,4 V L +B	Halterschraube				
	280 E Kombi	F242721	10.92	06.93	13.8190-0242.1	990124							
	300 CE 24 Cabrio		01.92	06.93									
	300 CE 24 Coupe		09.89	09.92									
	300 E 24		09.89	09.92									
	300 TE 24		09.89	09.92									
	320 CE	B862121	10.92	06.93									
	320 E	B864307	10.92	06.93									
320 TE	F242721	10.92	06.93										
280 E	B884947		06.93	24.0125-0107.1	425107	4	294 25,0 22,4 V L +B	Halterschraube					
280 E Kombi	F242722		06.93	13.8190-0242.1	990124								
320 CE	B862122		06.93										
320 E	B864308		06.93										
320 TE	F242722		06.93										
400 E	B938568	10.92	06.93										
500 E	B927760	01.91	06.93	24.0128-0103.1	428103		300 28,0 25,4 V L +B						
400 E	B938569		06.93	24.0130-0121.1	430121	4	320 30,0 28,0 V L +B	Halterschraube					
500 E	B927761		06.93	24.0130-0122.1	430122								
				13.8190-0242.1	990124								
	200 CE		04.90	06.93	24.5101-0346.3	331406	2	L=346					
	200 TE		10.88	06.93									
	220 CE		10.92	06.93									
	230 CE		05.87	06.93									
	250 TD Turbo		04.90	06.93									
	280 TE		10.92	06.93									
	320 CE		10.92	06.93									
	320 E		10.92	06.93									
	320 TE		10.92	06.93									
	400 E		10.92	06.93									
	500 E		01.91	06.93									
	alle Typen		01.85	06.93									
	alle Typen 4-Matic		05.85	06.93	83.6154-0526.3	330285					L=525		
		200		01.85	02.90	13.2351-8005.2				210014	4	D=35	ATE
		200 CE		04.90	06.93	13.2351-8006.2				210015		D=35	ATE
		200 D		01.85	06.93	24.9235-8005.5				230023		D=35	ATE
		200 E		01.85	06.93	24.9235-8006.5				230024		D=35	ATE
220 CE			10.92	06.93	13.0441-3505.2	250051	Dichtungssatz	ATE					
220 E			10.92	06.93									
230 CE			05.87	09.92									
230 E			01.85	09.92									
250 D			01.85	06.93	+ Radstand 2800mm ³⁾								
250 D Turbo			09.88	06.93									
260 E			01.85	09.92	- ASR/ + Radstand 2800mm ⁴⁾								
260 E 4-Matic			05.85	08.91									
280 E			10.92	06.93	- ASR/ + Radstand 2800mm ⁴⁾								
300 CE			05.87	09.92	- ASR								
300 D			01.85	06.93									
300 D 4-Matic			12.86	08.91									
300 D Turbo			09.87	06.93									
300 D Turbo 4-Matic			09.87	06.93									
300 E			01.85	09.92	- ASR								
300 E 4-Matic			11.86	06.93									
200 T			10.85	02.90	13.2381-8035.2	210037	4	D=38	ATE				
200 TD			10.85	06.93	24.9238-8035.5	230025		D=38	ATE				
200 TE			10.88	06.93	24.9238-8036.5	230026		D=38	ATE				
220 TE			10.92	06.93	13.0441-3811.2	250067		Dichtungssatz	ATE				
230 E Kombi			01.85	09.92	13.0441-3817.2	250071		Dichtungssatz	ATE				
230 TE			10.85	09.92									
250 D			01.90	06.93	+ Radstand 3600mm ¹⁾								
250 D Kombi			10.85	06.93	+ Spezialaufbau ²⁾								
250 TD			10.85	06.93									
250 TD Turbo			04.90	06.93	+ ⊕								
260 E			01.90	09.92	+ Radstand 3600mm ¹⁾								
260 E Kombi			10.85	09.92	+ Spezialaufbau ²⁾								
280 TE			10.92	06.93									
300 CE 24 Cabrio		01.92	06.93										
300 CE 24 Coupe		09.89	09.92										
300 E 24		09.89	09.92										
300 TD		04.86	06.93										
300 TD Turbo		10.85	06.93										
300 TD Turbo 4-Matic		03.87	06.93										
300 TE		10.85	09.92										
300 TE 4-Matic		11.86	06.93										
320 CE		10.92	06.93										
320 E		10.92	06.93										
400 E		10.92	06.93	13.2381-8034.2	210223	4	D=38	ATE					
500 E	B927760	01.91	06.93	24.9238-8033.5	230015		D=38	ATE					
			06.93	24.9238-8034.5	230016		D=38	ATE					
			06.93	13.0441-3817.2	250071		Dichtungssatz	ATE					
500 E	B927761		06.93	13.2421-8025.2	210061	4	D=42	ATE					
			06.93	13.2421-8026.2	210062		D=42	ATE					
			06.93	13.0441-4216.2	250093		Dichtungssatz	ATE					

1) + wheel base 3600 mm / + passo 3600 mm / + empattement 3600 mm / + distancia entre ejes 3600 mm
 2) + special body / + carrozzeria speciale / + carrosserie spéciale / + construcc.carroceria especial
 3) + wheel base 2800 mm / + passo 2800 mm / + empattement 2800 mm / + distancia entre ejes 2800 mm
 4) - ASR/ + wheel base 2800mm / - ASR/+ passo 2800mm / - ASR/+ empattement 2800mm / - ASR/+ dist.entre ejes 2800mm
 5) - WD fixture / - fissaggio segnalatore usura / - fixation de DA / - fijación del DD
 6) + WD fixture / + fissaggio segnalatore usura / + fixation de DA / + fijación del DD



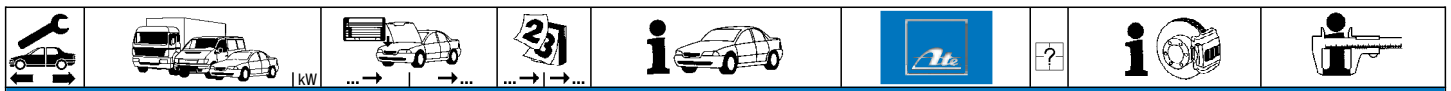

MERCEDES BENZ (W124) E-Klasse (85-93)

	200			01.85	02.90	13.0460-4034.2	604034			20687 15,5	ATE
	200 CE			04.90	06.93	13.0460-0186.2	610186			Belagsatz-Zubehör	ATE
	200 D			01.85	06.93						
	200 E			01.85	06.93						
	220 CE			10.92	06.93						
	220 E			10.92	06.93						
	230 CE			05.87	09.92						
	230 E			01.85	09.92						
	250 D			01.85	06.93	+ Radstand 2800mm ¹⁾					
	250 D Turbo			09.88	06.93						
	260 E			01.85	09.92	- ASR/ + Radstand 2800mm ²⁾					
	260 E 4-Matic			05.85	08.91						
	280 E			10.92	06.93	- ASR/ + Radstand 2800mm ²⁾					
	300 CE			05.87	09.92	- ASR					
	300 D			01.85	06.93						
	300 D 4-Matic			12.86	08.91						
	300 D Turbo			09.87	06.93						
	300 D Turbo 4-Matic			09.87	06.93	- ASR					
	300 E			01.85	09.92	- ASR					
	300 E 4-Matic			11.86	06.93						
	200 T			10.85	02.90	13.0460-3805.2	603805			21197 15,0 /WE	ATE
	200 TD			10.85	08.91	13.0470-3805.2	LD3805			21197 15,0 /WE	ATE
	200 TE			10.88	06.93	13.0460-0215.2	610215			Belagsatz-Zubehör	ATE
	220 TE			10.92	06.93	24.8190-0401.2	620401	4	+ ASR	Warnkontakt L=95mm	
	230 E Kombi			01.85	09.92	+ Spezialaufbau ³⁾					
	230 TE			10.85	09.92						
	250 D			01.90	06.93	+ Radstand 3600mm ⁴⁾					
	250 D Kombi			10.85	06.93	+ Spezialaufbau ³⁾					
	250 TD			10.85	06.93						
	250 TD Turbo			04.90	06.93	+ ⊕					
	260 E			01.90	09.92	+ Radstand 3600mm ⁴⁾					
	260 E Kombi			10.85	09.92	+ Spezialaufbau ³⁾					
	280 TE			10.92	06.93						
	300 CE 24 Cabrio			01.92	06.93						
	300 CE 24 Coupe			09.89	09.92						
	300 E 24			09.89	09.92						
	300 TD			04.86	06.93						
	300 TD Turbo			10.85	06.93						
	300 TD Turbo 4-Matic			03.87	06.93						
	300 TE			10.85	09.92						
300 TE 4-Matic			11.86	06.93							
320 CE			10.92	06.93							
320 E			10.92	06.93							
	260 E			09.89	09.92	+ ASR/ + Radstand 2800mm ⁵⁾	13.0460-3504.2	603504	4	21301 15,5 /WE	ATE
	280 E			10.92	06.93	+ ASR/ + Radstand 2800mm ⁵⁾	24.8190-0401.2	620401	4	Warnkontakt L=95mm	
	300 CE			09.89	09.92	+ ASR	13.0460-0171.2	610171		Belagsatz-Zubehör	ATE
	300 D Turbo 4-Matic			09.87	06.93	+ ASR					
	300 E			09.89	09.92	+ ASR					
	280 E			10.92	06.93	+ Radstand 3600mm ⁴⁾	13.0460-3805.2	603805		21197 15,0 /WE	ATE
	280 E Kombi			10.92	06.93	+ Spezialaufbau ³⁾	13.0470-3805.2	LD3805		21197 15,0 /WE	ATE
	300 TE 24			09.89	09.92		24.8190-0401.2	620401	4	Warnkontakt L=95mm	
	320 TE			10.92	06.93						
	400 E		B927760	10.92	06.93		13.0460-3805.2	603805		21197 15,0 /WE	ATE
	500 E			01.91			13.0470-3805.2	LD3805		21197 15,0 /WE	ATE
	500 E	B927761			06.93		13.0460-4047.2	604047		21305 15,7 /WE	ATE
							13.0470-4047.2	LD4047		21305 15,7 /WE	ATE
							13.0460-0236.2	610236	4	Belagsatz-Zubehör	ATE
	200			01.85	02.90	24.0109-0120.1	409120			258 9,0 7,3 +S +B	
	200 CE			04.90	06.93						
	200 D			01.85	06.93						
	200 E			01.85	06.93						
	220 CE			10.92	06.93						
	220 E			10.92	06.93						
	230 CE			05.87	09.92						
	230 E			01.85	09.92						
	250 D			01.85	06.93	+ Radstand 2800mm ¹⁾					
	250 D Turbo			09.88	06.93						
	260 E			01.85	09.92	+ Radstand 2800mm ¹⁾					
	260 E 4-Matic			05.85	08.91						
	280 E			10.92	06.93	+ Radstand 2800mm ¹⁾					
	300 CE			05.87	09.92						
	300 D			01.85	06.93						
	300 D 4-Matic			12.86	08.91						
	300 D Turbo			09.87	06.93						
	300 E			01.85	09.92						
	300 E 4-Matic			11.86	06.93						
		200 T			10.85	02.90	24.0109-0114.1	409114			278 9,0 7,3 +S +B
200 TD				10.85	08.91	24.0309-0114.1	509114			278 9,0 7,3 +S +B PD	
200 TE				10.88	06.93						
220 TE				10.92	06.93						
230 E Kombi				01.85	06.93	+ Spezialaufbau ³⁾					
230 TE				10.85	09.92						
250 D				01.90	06.93	+ Radstand 3600mm ⁴⁾					
250 D Kombi				10.85	06.93	+ Spezialaufbau ³⁾					
250 TD				10.85	06.93						

1) + wheel base 2800 mm / + passo 2800 mm / + empattement 2800 mm / + distancia entre ejes 2800 mm
 2) - ASR/ + wheel base 2800mm / - ASR/+ passo 2800mm / - ASR/+ empattement 2800mm / - ASR/+ dist.entre ejes 2800mm
 3) + special body / + carrozzeria speciale / + carrosserie spéciale / + construcc.carrocería especial
 4) + wheel base 3600 mm / + passo 3600 mm / + empattement 3600 mm / + distancia entre ejes 3600 mm
 5) + ASR/ + wheel base 2800mm / + ASR/ + passo 2800mm / + ASR/ + empattement 2800mm / + ASR/ + dist.entre ejes 2800 mm

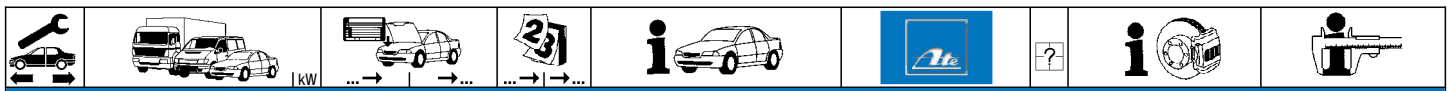

MERCEDES BENZ (W124) E-Klasse (85-93)

	250 TD Turbo		04.90	06.93	+ ①	24.0109-0114.1	409114		278 9,0 7,3 +S +B
	260 E		01.90	09.92	+ Radstand 3600mm ¹⁾	24.0309-0114.1	509114		278 9,0 7,3 +S +B PD
	260 E Kombi		10.85	06.93	+ Spezialaufbau ²⁾				
	280 TE		10.92	06.93					
	300 CE 24 Cabrio		01.92	06.93					
	300 CE 24 Coupe		09.89	09.92					
	300 E 24		09.89	09.92					
	300 TD		04.86	06.93					
	300 TD Turbo		10.85	06.93					
	300 TD Turbo 4-Matic		03.87	06.93					
300 TE		10.85	09.92						
300 TE 4-Matic		11.86	06.93						
320 CE		10.92	06.93						
320 E		10.92	06.93						
280 E		10.92	06.93	+ Radstand 3600mm ¹⁾	24.0120-0199.1	420199		278 19,9 17,4 V L	
280 E Kombi		10.92	06.93	+ Spezialaufbau ²⁾					
300 TE 24		09.89	09.92						
320 TE		10.92	06.93						
400 E		10.92	06.93		24.0124-0188.1	424188		278 24,0 21,4 V L +B	
500 E	B927761		06.93		24.0122-0218.1	422218		300 22,0 19,4 V L +B	
	200 CE		04.90	06.93		83.7704-0281.3	330804	2	L=280
	200 TE		10.88	06.93					
	220 CE		10.92	06.93					
	230 CE		05.87	06.93					
	250 TD Turbo		04.90	06.93					
	280 TE		10.92	06.93					
	300 D Turbo		09.87	06.93					
	320 CE		10.92	06.93					
	320 E		10.92	06.93					
	320 TE		10.92	06.93					
	400 E		10.92	06.93					
	500 E		01.91	06.93					
	alle Typen		01.85	06.93		03.0137-0170.2	650170		164 x 20 /Zub
	alle Typen Kombi		10.85	06.93	- Radstand 3450mm ³⁾	24.3727-0411.2	580411	1 ↗ + Linklenker ⁴⁾	L=2496
	alle Typen Lim.		01.85	06.93	- Radstand 3600mm ⁵⁾	24.3727-0409.2	580409	2 ↘	L=1060
	alle Typen Coupe		05.87	06.93		24.3727-0409.2	580409	2 ↘	L=1060
	alle Typen		01.85	06.93		24.2419-0915.3	030045	+ GG ⁶⁾	Gz 19,05
						24.2419-1703.3	030097	+ ALU ⁷⁾	Gz 19,05
	200		01.85	02.90		03.2523-1210.3	040021		Nz 23,81
	200 CE		04.90	06.93					
	200 D		01.85	06.93					
	200 E		01.85	06.93					
	200 T		10.85	02.90					
	200 TD		10.85	08.91					
	200 TE		10.88	06.93					
	230 CE		05.87	08.89					
	230 E		01.85	08.89					
	230 TE		10.85	08.89					
	250 D		01.85	08.89					
	250 TD		10.85	08.89					
	260 E		01.85	08.89					
	260 E 4-Matic		05.85	08.89					
	300 CE		05.87	08.89					
	300 D		01.85	08.89					
	300 E		01.85	08.89					
	300 E 4-Matic		11.86	08.89					
	300 TD		04.86	08.89					
	300 TE		10.85	08.89					
300 TE 4-Matic		11.86	08.89						
	220 CE		10.92	06.93		03.2523-1310.3	040022		Nz 23,81
	220 E		10.92	06.93					
	220 TE		10.92	06.93					
	230 CE		09.89	09.92					
	230 E		09.89	09.92					
	230 TE		09.89	09.92					
	250 D		09.89	06.93					
	250 D Turbo		09.88	06.93					
	250 TD		09.89	06.93					
	250 TD Turbo		04.90	06.93	+ ①				
	260 E		09.89	09.92					
	260 E 4-Matic		09.89	08.91					
	280 TE		10.92	06.93					
	300 CE		09.89	09.92					
	300 CE 24 Cabrio		01.92	06.93					
	300 CE 24 Coupe		09.89	09.92					
	300 D		09.89	06.93					
	300 D 4-Matic		09.89	08.91					
	300 E		09.89	09.92					
	300 E 24		09.89	09.92					
	300 E 4-Matic		09.89	06.93					
	300 TD		09.89	06.93					
	300 TE		09.89	09.92					

1) + wheel base 3600 mm / + passo 3600 mm / + empattement 3600 mm / + distancia entre ejes 3600 mm

2) + special body / + carrozzeria speciale / + carrosserie spéciale / + construcc.carroceria especial

3) - wheel base 3450mm / - passo 3450mm / - empattement 3450mm / - distancia entre ejes 3450mm

4) + left hand drive / + guida a sinistra / + conduite à gauche / + volante a la izquierda

5) - wheel base 3600mm / - passo 3600mm / - empattement 3600mm / - distancia entre ejes 3600mm

6) + cast iron / + ghisa / + fonte grise / + fundición de gris

7) + aluminium / + alluminio / + aluminium / + aluminio



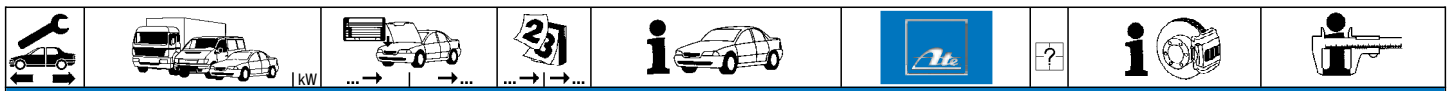

MERCEDES BENZ (W124) E-Klasse (85-93)

	300 TE 24 300 TE 4-Matic 320 CE 320 E 320 TE			09.89 09.89 10.92 10.92 10.92	09.92 06.93 06.93 06.93 06.93		03.2523-1310.3	040022		Nz 23,81
--	--	--	--	---	---	--	----------------	--------	--	----------

MERCEDES BENZ E-Klasse (W124) Limousine (93-95)

	E 200 E 200 D E 220 E 250 D E 250 Turbo-D E 280 E 300 4-matic E 300 D E 300 Turbo-D E 300 Turbo-D 4-matic E 320 E 36 AMG	100 55 110 83 93 145 132 100 108 108 162 200		06.93 06.93 06.93 07.93 06.93 06.93 06.93 07.93 06.93 06.93 06.93 05.94	06.95 06.95 06.95 06.95 06.95 06.95 06.95 06.95 06.95 06.95 06.95 06.95		03.7760-2702.4	300090		10"	ATE
	E 200 E 200 D E 220 E 250 D E 250 Turbo-D E 280 E 280 E 300 4-matic E 300 D E 300 Turbo-D E 300 Turbo-D 4-matic E 320 E 36 AMG	100 55 110 83 93 142 145 132 100 108 108 162 200	C 164263 C 164263 C 164263 C 164263 C 164263 C 164263 C 164263 C 164263 C 164263 C 164263 C 164263 C 164263 C 164263	06.93 06.93 06.93 07.93 06.93 06.93 06.93 06.93 07.93 06.93 06.93 06.93 07.94	06.95 06.95 06.95 06.95 06.95 06.95 06.95 06.95 06.95 06.95 06.95 06.95 06.95		03.2023-0825.3	010028		Thz 23,81/19,05	ATE
	E 320 E 420 E 500 E 60 AMG	162 205 235 280	C 164263 C 164263 B 927760 B 927760	06.93 06.93 06.93 05.94	06.93 06.93 06.93 06.95		03.2025-0211.3	010034		Thz 25,40/19,05	ATE
	E 200 E 220 E 250 Turbo-D E 280 E 300 D E 300 Turbo-D	100 110 93 145 100 108		06.93 06.93 06.93 06.93 07.93 06.93	06.95 06.95 06.95 06.95 06.95 06.95		24.3541-1603.5 24.3541-1604.5 24.0101-3601.2 11.0101-5403.2	240037 240038 260044 260010	 	D=54, - Halter D=54, - Halter Bremsattel-Zubehör Faltenbalgsatz	LUC LUC LUC LUC
	E 200 D E 250 D	55 83		06.93 07.93	06.95 06.95		24.3541-1725.5 24.3541-1726.5 11.0441-5404.2 11.0101-5403.2	240003 240004 250029 260010	 	D=54, - Halter D=54, - Halter Dichtungssatz Faltenbalgsatz	LUC LUC LUC LUC
	E 280 E 320	142 162	B 864307 B 864307	06.93 06.93	06.95 06.95		13.0441-4214.2	250091		Dichtungssatz	ATE
	E 280 E 320 E 420	142 B 864308 162 B 864308 205	B 938568	06.93 06.95 06.95	06.95 06.95 06.95		13.0441-4214.2	250091		Dichtungssatz	ATE
	E 300 4-matic E 300 Turbo-D 4-matic	132 108		06.93 06.93	06.95 06.95		11.0441-5404.2 11.0101-5403.2	250029 260010		Dichtungssatz Faltenbalgsatz	LUC LUC
	E 36 AMG E 420 E 500 E 60 AMG	200 205 B 938569 235 B 927761 280		07.94 06.93 06.93 05.94	06.95 06.95 06.95 06.95		13.0441-4214.2	250091		Dichtungssatz	ATE
	E 500	235	B 927760	06.93	06.95		24.9442-8003.5 24.9442-8004.5	230053 230054	 	D=42/38 D=42/38	ATE ATE
	E 200 E 200 D E 220 E 250 D E 250 Turbo-D E 280 E 300 4-matic E 300 D E 300 Turbo-D E 300 Turbo-D 4-matic	100 55 110 83 93 145 132 100 108 108		06.93 06.93 06.93 07.93 06.93 06.93 06.93 07.93 06.93 06.93	06.95 06.95 06.95 06.95 06.95 06.95 06.95 06.95 06.95 06.95		13.0460-2927.2 13.0470-2927.2 24.8190-0402.2	602927 LD2927 620402	2	20941 19,3 /WE/S 20941 19,3 /WE/S Warnkontakt L=68(150)mm	LUC LUC
	E 280 E 320 E 36 AMG E 420 E 500 E 60 AMG	142 162 200 205 B 938569 235 280	B 864307 B 864307	06.93 06.93 07.94 06.93 06.93 05.94	06.95 06.95 06.95 06.95 06.95 06.95		13.0460-4201.2 24.8190-0401.2 13.0460-0219.2	604201 620401 610219	2	21153 17,5 /WE Warnkontakt L=95mm Belagsatz-Zubehör	ATE ATE
	E 280 E 320 E 420	142 B 864308 162 B 864308 205	B 938568	06.93 06.95 06.95	06.95 06.95 06.95		13.0460-4202.2 24.8190-0401.2 13.0460-0268.2	604202 620401 610268	2	21153 16,0 /WE Warnkontakt L=95mm Belagsatz-Zubehör	ATE
	E 200 E 220 E 250 Turbo-D E 280 E 300 D E 300 Turbo-D	100 110 93 145 100 108		06.93 06.93 06.93 06.93 07.93 06.93	06.95 06.95 06.95 06.95 06.95 06.95		24.0122-0123.1 13.8190-0242.1	422123 990124	4	284 22,0 19,4 V L +S +B Halterschraube	
	E 200 D	55		06.93	06.95		24.0112-0117.1	412117		284 12,0 10,0 +S +B	



MERCEDES BENZ E-Klasse (W124) Limousine (93-95)											
	E 250 D	83		07.93	06.95	24.0112-0117.1	412117			284 12,0 10,0 +S +B	
	E 300 4-matic	132		06.93	06.95	24.0122-0134.1	422134			284 22,0 19,4 V L +B	
	E 300 Turbo-D 4-matic	108		06.93	06.95	13.8190-0330.1	990134	4		Halterschraube	
	E 280	142	B 864307	06.93		24.0122-0136.1	422136			295 22,0 19,4 V L +B	
	E 320	162	B 864307	06.93		13.8190-0242.1	990124	4		Halterschraube	
	E 280	142	B 864308		06.95	24.0125-0107.1	425107			294 25,0 22,4 V L +B	
	E 320	162	B 864308		06.95	13.8190-0242.1	990124	4		Halterschraube	
	E 420	205	B 938568	06.93							
	E 36 AMG	200		07.94	06.95	24.0130-0121.1	430121		☐	320 30,0 28,0 V L +B	
	E 420	205	B 938569		06.95	24.0130-0122.1	430122		☐	320 30,0 28,0 V L +B	
E 500	235	B 927761		06.95							
E 60 AMG	280		05.94	06.95							
E 500	235	B 927760	06.93		24.0128-0103.1	428103			300 28,0 25,4 V L +B		
	E 200	100		06.93	06.95	24.5101-0346.3	331406	2		L=346	
	E 200 D	55		06.93	06.95						
	E 220	110		06.93	06.95						
	E 250 D	83		07.93	06.95						
	E 250 Turbo-D	93		06.93	06.95						
	E 280	142		06.93	06.95						
	E 280	145		06.93	06.95						
	E 300 D	100		07.93	06.95						
	E 300 Turbo-D	108		06.93	06.95						
	E 320	162		06.93	06.95						
	E 36 AMG	200		07.94	06.95						
	E 420	205		06.93	06.95						
	E 500	235		06.93	06.95						
	E 60 AMG	280		05.94	06.95						
	E 300 4-matic	132		06.93	06.95	83.6154-0526.3	330285	2		L=525	
	E 300 Turbo-D 4-matic	108		06.93	06.95						
		E 200	100		06.93	06.95	13.2351-8005.2	210014		☐	D=35 ATE
E 200 D		55		06.93	06.95	13.2351-8006.2	210015		☐	D=35 ATE	
E 220		110		06.93	06.95	24.9235-8005.5	230023		☐	D=35 ATE	
E 250 D		83		07.93	06.95	24.9235-8006.5	230024		☐	D=35 ATE	
E 250 Turbo-D		93		06.93	06.95	13.0441-3505.2	250051			Dichtungssatz ATE	
E 280		145		06.93	06.95	- ASR					
E 300 4-matic		132		06.93	06.95						
E 300 D		100		07.93	06.95						
E 300 Turbo-D		108		06.93	06.95						
E 300 Turbo-D 4-matic		108		06.93	06.95						
E 280		145		06.93	06.95	+ ASR	13.0441-3505.2	250051			Dichtungssatz ATE
E 320		162		06.93	06.95		13.2381-8035.2	210037		☐	D=38 ATE
E 36 AMG		200		07.94	06.95		24.9238-8035.5	230025		☐	D=38 ATE
							24.9238-8036.5	230026		☐	D=38 ATE
							13.0441-3817.2	250071			Dichtungssatz ATE
E 420		205		06.93	06.95		13.2381-8034.2	210223		☐	D=38 ATE
E 500		235	B 927760	06.93			24.9238-8033.5	230015		☐	D=38 ATE
E 60 AMG	280	B 927760	05.94			24.9238-8034.5	230016		☐	D=38 ATE	
						13.0441-3817.2	250071			Dichtungssatz ATE	
E 500	235	B 927761		06.95		13.2421-8025.2	210061		☐	D=42 ATE	
E 60 AMG	280	B 927761		06.95		13.2421-8026.2	210062		☐	D=42 ATE	
						13.0441-4216.2	250093			Dichtungssatz ATE	
	E 200	100		06.93	06.95	13.0460-4034.2	604034			20687 15,5 ATE	
	E 200 D	55		06.93	06.95	13.0460-0186.2	610186			Belagsatz-Zubehör ATE	
	E 220	110		06.93	06.95						
	E 250 D	83		07.93	06.95						
	E 250 Turbo-D	93		06.93	06.95						
	E 280	145		06.93	06.95	- ASR					
	E 300 4-matic	132		06.93	06.95						
	E 300 D	100		07.93	06.95						
	E 300 Turbo-D	108		06.93	06.95						
	E 300 Turbo-D 4-matic	108		06.93	06.95						
	E 280	145		06.93	06.95	+ ASR	13.0460-3504.2	603504			21301 15,5 /WE ATE
							24.8190-0401.2	620401	4		Warnkontakt L=95mm
	E 280	142		06.93	06.95		13.0460-3805.2	603805			21197 15,0 /WE ATE
	E 320	162		06.93	06.95		13.0470-3805.2	LD3805			21197 15,0 /WE ATE
	E 36 AMG	200		07.94	06.95		24.8190-0401.2	620401	2		Warnkontakt L=95mm
	E 420	205		06.93	06.95						
	E 500	235	B 927760	06.93							
E 60 AMG	280	B 927760	05.94								
E 500	235	B 927761		06.95		13.0460-4047.2	604047			21305 15,7 /WE ATE	
E 60 AMG	280	B 927761		06.95		13.0470-4047.2	LD4047			21305 15,7 /WE ATE	
						13.0460-0236.2	610236			Belagsatz-Zubehör ATE	
						24.8190-0401.2	620401	4		Warnkontakt L=95mm	
	E 200	100		06.93	06.95	24.0109-0120.1	409120			258 9,0 7,3 +S +B	
	E 200 D	55		06.93	06.95	24.0309-0120.1	509120			258 9,0 7,3 +S +B PD	
	E 220	110		06.93	06.95						
	E 250 D	83		07.93	06.95						
	E 250 Turbo-D	93		06.93	06.95						
	E 280	145		06.93	06.95						
	E 300 4-matic	132		06.93	06.95						
	E 300 D	100		07.93	06.95						
	E 300 Turbo-D	108		06.93	06.95						
	E 300 Turbo-D 4-matic	108		06.93	06.95						
E 280	142		06.93	06.95	24.0120-0199.1	420199			278 19,9 17,4 V L		

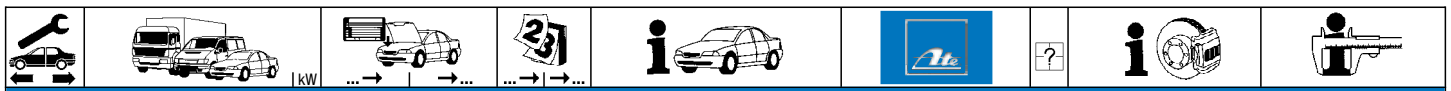

MERCEDES BENZ E-Klasse (W124) Limousine (93-95)

	E 320	162	06.93	06.95	24.0109-0114.1	409114		278 9,0 7,3 +S +B
	E 36 AMG	200	07.94	06.95	24.0309-0114.1	509114		278 9,0 7,3 +S +B PD
	E 420	205	06.93	06.95	24.0124-0188.1	424188		278 24,0 21,4 VL +B
	E 500	235 B 927761		06.95	24.0122-0218.1	422218		300 22,0 19,4 VL +B
	E 60 AMG	280 B 927761		06.95				
	E 200	100	06.93	06.95	83.7704-0281.3	330804	2	L=280
	E 200 D	55	06.93	06.95				
	E 220	110	06.93	06.95				
	E 250 D	83	07.93	06.95				
	E 250 Turbo-D	93	06.93	06.95				
	E 280	142	06.93	06.95				
	E 280	145	06.93	06.95				
	E 300 4-matic	132	06.93	06.95				
	E 300 D	100	07.93	06.95				
	E 300 Turbo-D	108	06.93	06.95				
	E 300 Turbo-D 4-matic	108	06.93	06.95				
	E 320	162	06.93	06.95				
	E 36 AMG	200	07.94	06.95				
	E 420	205	06.93	06.95				
	E 500	235	06.93	06.95				
E 60 AMG	280	05.94	06.95					
	E 200	100	06.93	06.95	03.0137-0170.2	650170		164 x 20 /Zub
	E 200 D	55	06.93	06.95				
	E 220	110	06.93	06.95				
	E 250 D	83	07.93	06.95				
	E 250 Turbo-D	93	06.93	06.95				
	E 280	142	06.93	06.95				
	E 280	145	06.93	06.95				
	E 300 4-matic	132	06.93	06.95				
	E 300 D	100	07.93	06.95				
	E 300 Turbo-D	108	06.93	06.95				
	E 300 Turbo-D 4-matic	108	06.93	06.95				
	E 320	162	06.93	06.95				
	E 36 AMG	200	07.94	06.95				
	E 420	205	06.93	06.95				
	E 500	235	06.93	06.95				
E 60 AMG	280	05.94	06.95					
	E 200	100	06.93	06.95	24.3727-0411.2	580411	1 ↑	L=2496
	E 200 D	55	06.93	06.95	24.3727-0409.2	580409	2 ↓	L=1060
	E 220	110	06.93	06.95				
	E 250 D	83	07.93	06.95				
	E 250 Turbo-D	93	06.93	06.95				
	E 280	142	06.93	06.95				
	E 280	145	06.93	06.95				
	E 300 4-matic	132	06.93	06.95				
	E 300 D	100	07.93	06.95				
	E 300 Turbo-D	108	06.93	06.95				
	E 300 Turbo-D 4-matic	108	06.93	06.95				
	E 320	162	06.93	06.95				
	E 36 AMG	200	07.94	06.95				
	E 420	205	06.93	06.95				
	E 500	235	06.93	06.95				
E 60 AMG	280	05.94	06.95					
	E 200	100	06.93	06.95	24.2419-0915.3	030045	+ GG ¹⁾	Gz 19,05
	E 200 D	55	06.93	06.95	24.2419-1703.3	030097	+ ALU ²⁾	Gz 19,05
	E 220	110	06.93	06.95				
	E 250 D	83	07.93	06.95				
	E 250 Turbo-D	93	06.93	06.95				
	E 280	142	06.93	06.95				
	E 280	145	06.93	06.95				
	E 300 D	100	07.93	06.95				
	E 320	162	06.93	06.95				
	E 36 AMG	200	07.94	06.95				
	E 200	100	06.93	06.95	03.2523-1210.3	040021		Nz 23,81
	E 200 D	55	06.93	06.95	03.2523-1310.3	040022		Nz 23,81
	E 220	110	06.93	06.95	03.2523-1310.3	040022		Nz 23,81
	E 250 D	83	07.93	06.95				
	E 250 Turbo-D	93	06.93	06.95				
	E 280	142	06.93	06.95				
	E 280	145	06.93	06.95				
	E 300 D	100	07.93	06.95				
	E 320	162	06.93	06.95				
	E 36 AMG	200	07.94	06.95				

MERCEDES BENZ E-Klasse (S124) Kombi (93-96)

	E 200	100	06.93	06.96	03.7760-2702.4	300090		10" ATE
	E 220	110	06.93	06.96				
	E 250 D	83	06.93	06.96				
	E 250 Turbo D	93	06.93	06.96				
	E 280	145	06.93	06.96				
	E 300 4-matic	132	06.93	06.96				
	E 300 D	100	06.93	06.96				
	E 300 TE-24	162	06.93	06.96				
	E 300 Turbo D	108	06.93	06.96				
	E 300 Turbo D 4-matic	108	06.93	06.96				
E 320	162	06.93	06.96					

1) + cast iron / + ghisa / + fonte grise / + fundición de gris

2) + aluminium / + alluminio / + aluminium / + aluminio

MERCEDES BENZ E-Klasse (S124) Kombi (93-96)											
	E 36 AMG	200		05.94	06.96		03.7760-2702.4	300090	10"	ATE	
	E 200	100	F 298225	06.93			03.2023-0825.3	010028		17x 23,81/19,05	ATE
	E 220	110	F 298225	06.93							
	E 250 D	83	F 298225	06.93							
	E 250 Turbo D	93	F 298225	06.93							
	E 280	145	F 298225	06.93							
	E 300 4-matic	132	F 298225	06.93							
	E 300 D	100	C 164263	06.93							
	E 300 TE-24	162		06.93	06.96						
	E 300 Turbo D	108	C 164263	06.93							
	E 300 Turbo D 4-matic	108	F 298225	06.93							
	E 320	162	F 298225	06.93							
	E 36 AMG	200	F 298225	05.94							
	E 200	100		06.93	06.96		24.3541-1603.5	240037		D=54, - Halter	LUC
	E 220	110		06.93	06.96		24.3541-1604.5	240038		D=54, - Halter	LUC
	E 250 Turbo D	93		06.93	06.96		24.0101-3601.2	260044		Bremssattel-Zubehör	LUC
	E 280	145		06.93	06.96						
	E 300 D	100		06.93	06.96						
	E 300 Turbo D	108		06.93	06.96						
	E 250 D	83		06.93	06.96		24.3541-1725.5	240003		D=54, - Halter	LUC
							24.3541-1726.5	240004		D=54, - Halter	LUC
							11.0441-5404.2	250029		Dichtungssatz	LUC
							11.0101-5403.2	260010		Faltenbalgsatz	LUC
	E 300 TE-24	162		06.93	06.96		13.0441-4214.2	250091		Dichtungssatz	ATE
	E 320	162	F 242721	06.93							
	E 320	162	F 242722		06.96		13.0441-4214.2	250091		Dichtungssatz	ATE
	E 200	100		06.93	06.96		13.0460-2927.2	602927		20941 19,3 /WE/S	LUC
	E 220	110		06.93	06.96		13.0470-2927.2	LD2927		20941 19,3 /WE/S	LUC
	E 250 D	83		06.93	06.96		24.8190-0402.2	620402	2	Warnkontakt L=68(150)mm	
	E 250 Turbo D	93		06.93	06.96						
	E 280	145		06.93	06.96						
	E 300 4-matic	132		06.93	06.96						
	E 300 D	100		06.93	06.96						
	E 300 Turbo D	108		06.93	06.96						
	E 300 Turbo D 4-matic	108		06.93	06.96						
	E 300 TE-24	162		06.93	06.96		13.0460-4201.2	604201		21153 17,5 /WE	ATE
	E 320	162	F 242721	06.93			24.8190-0401.2	620401	2	Warnkontakt L=95mm	
	E 36 AMG	200		05.94	06.96						
	E 320	162	F 242722		06.96		13.0460-4202.2	604202		21153 16,0 /WE	ATE
							13.0460-0268.2	610268		Belagsatz-Zubehör	
							24.8190-0401.2	620401	2	Warnkontakt L=95mm	
	E 200	100		06.93	06.96		24.0122-0123.1	422123		284 22,0 19,4 V L +S +B	
	E 220	110		06.93	06.96		13.8190-0242.1	990124	4	Halterschraube	
	E 250 Turbo D	93		06.93	06.96						
	E 280	145		06.93	06.96						
	E 300 D	100		06.93	06.96						
	E 300 Turbo D	108		06.93	06.96						
	E 250 D	83		06.93	06.96		24.0112-0117.1	412117		284 12,0 10,0 +S +B	
							13.8190-0242.1	990124	4	Halterschraube	
	E 300 4-matic	132		06.93	06.96		24.0122-0134.1	422134		284 22,0 19,4 V L +B	
	E 300 Turbo D 4-matic	108		06.93	06.96		13.8190-0330.1	990134	4	Halterschraube	
	E 300 TE-24	162		06.93	06.96		24.0122-0136.1	422136		295 22,0 19,4 V L +B	
	E 320	162	F 242721	06.93							
	E 320	162	F 242722		06.96		24.0125-0107.1	425107		294 25,0 22,4 V L +B	
							13.8190-0242.1	990124	4	Halterschraube	
	E 36 AMG	200		05.94	06.96		24.0130-0121.1	430121		320 30,0 28,0 V L +B	
							24.0130-0122.1	430122		320 30,0 28,0 V L +B	
							13.8190-0242.1	990124	4	Halterschraube	
	E 200	100		06.93	06.96		24.5101-0346.3	331406	2	L=346	
	E 220	110		06.93	06.96						
	E 250 D	83		06.93	06.96						
	E 250 Turbo D	93		06.93	06.96						
	E 280	145		06.93	06.96						
	E 300 D	100		06.93	06.96						
	E 300 TE-24	162		06.93	06.96						
	E 300 Turbo D	108		06.93	06.96						
	E 320	162		06.93	06.96						
	E 36 AMG	200		05.94	06.96						
	E 300 4-matic	132		06.93	06.96		83.6154-0526.3	330285	2	L=525	
	E 300 Turbo D 4-matic	108		06.93	06.96						
	E 200	100		06.93	06.96		13.2381-8035.2	210037		D=38	ATE
	E 220	110		06.93	06.96		24.9238-8035.5	230025		D=38	ATE
	E 250 D	83		06.93	06.96		24.9238-8036.5	230026		D=38	ATE
	E 250 Turbo D	93		06.93	06.96		13.0441-3817.2	250071		Dichtungssatz	ATE
	E 280	145		06.93	06.96						
	E 300 4-matic	132		06.93	06.96						
	E 300 D	100		06.93	06.96						
	E 300 Turbo D	108		06.93	06.96						
	E 300 Turbo D 4-matic	108		06.93	06.96						
	E 320	162	F 323056		06.96		13.0441-3606.2	250147		Dichtungssatz	ATE
	E 36 AMG	200	F 323056		06.96						



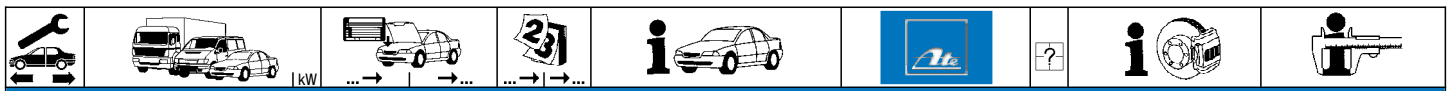











MERCEDES BENZ E-Klasse (S124) Kombi (93-96)

	E 200	100		06.93	06.96	13.0460-3805.2	603805	2		21197 15,0 /WE 21197 15,0 /WE Belagsatz-Zubehör Warnkontakt L=95mm	ATE ATE ATE					
	E 220	110		06.93	06.96	13.0470-3805.2	LD3805									
	E 250 D	83		06.93	06.96	13.0460-0186.2	610186									
	E 250 Turbo D	93		06.93	06.96	24.8190-0401.2	620401									
	E 280	145		06.93	06.96											
	E 300 4-matic	132		06.93	06.96											
	E 300 D	100		06.93	06.96											
	E 300 TE-24	162		06.93	06.96											
	E 300 Turbo D	108		06.93	06.96											
	E 300 Turbo D 4-matic	108		06.93	06.96											
	E 320	162	F 323055	06.93	06.96											
E 36 AMG	200	F 323055	05.94	06.96												
E 320	162	F 323056		06.96	13.0460-4047.2	604047	2		21305 15,7 /WE 21305 15,7 /WE Warnkontakt L=95mm Belagsatz-Zubehör	ATE ATE ATE						
E 36 AMG	200	F 323056		06.96	13.0470-4047.2	LD4047										
	E 200	100		06.93	06.96	24.0109-0114.1	409114			278 9,0 7,3 +S +B 278 9,0 7,3 +S +B PD						
	E 220	110		06.93	06.96	24.0309-0114.1	509114									
	E 250 D	83		06.93	06.96											
	E 250 Turbo D	93		06.93	06.96											
	E 280	145		06.93	06.96											
	E 300 4-matic	132		06.93	06.96											
	E 300 D	100		06.93	06.96											
	E 300 Turbo D	108		06.93	06.96											
	E 300 Turbo D 4-matic	108		06.93	06.96											
	E 300 TE-24	162		06.93	06.96	24.0120-0199.1	420199									
	E 320	162	F 323055	06.93	06.96											
E 36 AMG	200	F 323055	05.94	06.96												
	E 200	100		06.93	06.96	83.7704-0281.3	330804	2		L=280						
	E 220	110		06.93	06.96											
	E 250 D	83		06.93	06.96											
	E 250 Turbo D	93		06.93	06.96											
	E 280	145		06.93	06.96											
	E 300 4-matic	132		06.93	06.96											
	E 300 D	100		06.93	06.96											
	E 300 TE-24	162		06.93	06.96											
	E 300 Turbo D	108		06.93	06.96											
	E 300 Turbo D 4-matic	108		06.93	06.96											
	E 320	162		06.93	06.96											
E 36 AMG	200		05.94	06.96												
	E 200	100		06.93	06.96	03.0137-0170.2	650170			164 x 20 /Zub						
	E 220	110		06.93	06.96											
	E 250 D	83		06.93	06.96											
	E 250 Turbo D	93		06.93	06.96											
	E 280	145		06.93	06.96											
	E 300 4-matic	132		06.93	06.96											
	E 300 D	100		06.93	06.96											
	E 300 TE-24	162		06.93	06.96											
	E 300 Turbo D	108		06.93	06.96											
	E 300 Turbo D 4-matic	108		06.93	06.96											
	E 320	162		06.93	06.96											
E 36 AMG	200		05.94	06.96												
	E 200	100		06.93	06.96	24.3727-0411.2	580411	1 ↑ 2 ↓		L=2496 L=1060						
	E 220	110		06.93	06.96	24.3727-0409.2	580409									
	E 250 D	83		06.93	06.96											
	E 250 Turbo D	93		06.93	06.96											
	E 280	145		06.93	06.96											
	E 300 4-matic	132		06.93	06.96											
	E 300 D	100		06.93	06.96											
	E 300 TE-24	162		06.93	06.96											
	E 300 Turbo D	108		06.93	06.96											
	E 300 Turbo D 4-matic	108		06.93	06.96											
	E 320	162		06.93	06.96											
E 36 AMG	200		05.94	06.96												
	E 200	100		06.93	06.96	24.2419-0915.3	030045							Gz 19,05 Gz 19,05		
	E 220	110		06.93	06.96	24.2419-1703.3	030097									
	E 250 D	83		06.93	06.96											
	E 250 Turbo D	93		06.93	06.96											
	E 280	145		06.93	06.96											
	E 300 D	100		06.93	06.96											
	E 300 TE-24	162		06.93	06.96											
	E 320	162		06.93	06.96											
	E 36 AMG	200		05.94	06.96											
		E 200	100		06.93	06.96	03.2523-1310.3	040022			Nz 23,81					
		E 220	110		06.93	06.96										
E 250 D		83		06.93	06.96											
E 250 Turbo D		93		06.93	06.96											
E 280		145		06.93	06.96											
E 300 D		100		06.93	06.96											
E 300 TE-24		162		06.93	06.96											
E 320		162		06.93	06.96											
E 36 AMG		200		05.94	06.96											

1) + cast iron / + ghisa / + fonte grise / + fundición de gris























2) + aluminium / + alluminio / + aluminium / + aluminio













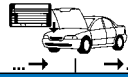















MERCEDES BENZ (W126) 260 SE-560 SEC (80-91)										
	280 S 280 SE 280 SEL 380 SE 380 SEC 380 SEL 500 SE 500 SEC 500 SEL			01.80 01.80 05.80 01.80 06.81 05.80 01.80 06.81 05.80	07.85 07.85 07.85 08.85 07.85 07.85 08.85 08.85 08.85		03.6855-1202.4	300056		9" Tandem ATE
	280 S 280 SE 280 SEL 380 SE 380 SEC 380 SEL 500 SE 500 SEC 500 SEL		027696 095332 095332 048641 007911 048641 036885 007817 036885	01.80 01.80 05.80 01.80 06.81 05.80 01.80 06.81 05.80			03.2023-0166.3	010015		THz 23,81/19,05 ATE
	280 S 280 SE 280 SEL 380 SE 380 SEC 380 SEL 500 SE 500 SEC 500 SEL	027697 095333 095333 048642 007912 048642 036886 007818 036886			07.85 07.85 07.85 08.85 07.85 07.85 08.85 08.85 08.85		03.2025-0111.3	010033		THz 25,40/19,05 ATE
	260 SE 300 SE 300 SEL 420 SE 420 SEC 420 SEL 500 SE 500 SEC 500 SEL 560 SE 560 SEC 560 SEL			09.85 09.85 09.85 09.85 09.85 09.85 09.85 09.85 09.85 07.88 09.85 09.85	03.91 03.91 03.91 03.91 08.91 03.91 03.91 08.91 03.91 03.91 08.91 03.91		03.2025-0211.3	010034		THz 25,40/19,05 ATE
	280 S 280 SE 280 SEL 380 SE 380 SEL 500 SE 500 SEL			01.80 01.80 05.80 01.80 05.80 01.80 05.80	07.85 07.85 07.85 08.85 07.85 08.85 08.85		24.9260-8031.5 24.9260-8032.5 13.0441-6003.2	230045 230046 250128	 	D=60 D=60 Dichtungssatz ATE ATE ATE
	260 SE 300 SE 300 SEL 420 SE 420 SEC 420 SEL 500 SE 500 SEC 500 SEL 560 SE 560 SEC 560 SEL			09.85 09.85 09.85 09.85 09.85 09.85 09.85 09.85 09.85 07.88 09.85 09.85	03.91 03.91 03.91 03.91 08.91 03.91 03.91 08.91 03.91 03.91 08.91 03.91		13.2571-8023.2 13.2571-8024.2 13.0441-5724.2	210127 210128 250125	 	D=57 D=57 Dichtungssatz ATE ATE ATE
	280 S 280 SE 280 SEL 380 SE 380 SEL 500 SE 500 SEL			01.80 01.80 05.80 01.80 05.80 01.80 05.80	07.85 07.85 07.85 08.85 07.85 08.85 08.85		13.0460-9029.2 13.0460-0132.2 24.8190-0401.2	609029 610132 620401	4	20341 16,7 /WE Belagsatz-Zubehör Warnkontakt L=95mm ATE ATE
	260 SE 300 SE 300 SEL 420 SE 420 SEC 420 SEL 500 SE 500 SEC 500 SEL 560 SE 560 SEC 560 SEL			09.85 09.85 09.85 09.85 09.85 09.85 09.85 09.85 09.85 07.88 09.85 09.85	03.91 03.91 03.91 03.91 08.91 03.91 03.91 08.91 03.91 03.91 08.91 03.91		13.0460-9029.2 13.0460-0197.2 24.8190-0401.2	609029 610197 620401	4	20341 16,7 /WE Belagsatz-Zubehör Warnkontakt L=95mm ATE ATE
	280 S 280 SE 280 SEL 380 SE 380 SEL 500 SE 500 SEL			01.80 01.80 05.80 01.80 05.80 01.80 05.80	07.85 07.85 07.85 08.85 07.85 08.85 08.85		24.0122-0116.1	422116		278 22,0 19,4 V
	260 SE 300 SE			09.85 09.85	03.91 03.91		24.0128-0102.1	428102		300 28,0 25,4 V L +B

























MERCEDES BENZ (W126) 260 SE-560 SEC (80-91)

	300 SEL 420 SE 420 SEC 420 SEL 500 SE 500 SEC 500 SEL 560 SE 560 SEC 560 SEL		09.85 03.91 09.85 03.91 09.85 08.91 09.85 03.91 09.85 03.91 09.85 08.91 09.85 03.91 07.88 03.91 09.85 08.91 09.85 03.91	24.0128-0102.1	428102			300 28,0 25,4 VL +B	
	260 SE 280 S 280 SE 280 SEL 300 SE 300 SEL 380 SE 380 SEC 380 SEL 420 SE 420 SEC 420 SEL 500 SE 500 SEC 500 SEL 560 SE 560 SEC 560 SEL		09.85 03.91 01.80 07.85 01.80 07.85 05.80 07.85 09.85 03.91 09.85 03.91 01.80 08.85 06.81 07.85 05.80 07.85 09.85 03.91 09.85 08.91 09.85 03.91 01.80 03.91 06.81 08.91 05.80 03.91 07.88 03.91 09.85 08.91 09.85 03.91	24.5101-0346.3	331406	2		L=346	
	260 SE 280 S 280 SE 280 SEL 300 SE 300 SEL 380 SE 380 SEC 380 SEL 420 SE 420 SEC 420 SEL 500 SE 500 SEC 500 SEL 560 SE 560 SEC 560 SEL		09.85 03.91 01.80 07.85 01.80 07.85 05.80 07.85 09.85 03.91 09.85 03.91 01.80 08.85 06.81 07.85 05.80 07.85 09.85 03.91 09.85 08.91 09.85 03.91 01.80 03.91 06.81 08.91 05.80 03.91 07.88 03.91 09.85 08.91 09.85 03.91	13.2381-8027.2 13.2381-8028.2 13.0441-3811.2	210033 210034 250067			D=38 D=38 Dichtungssatz	ATE ATE ATE
	500 SE 500 SEC 500 SEL 560 SE 560 SEC 560 SEL		01.80 03.91 06.81 08.91 05.80 03.91 07.88 03.91 09.85 08.91 09.85 03.91	13.2381-8029.2 13.2381-8030.2 13.0441-3811.2	210035 210036 250067			D=38 D=38 Dichtungssatz	ATE ATE ATE
	260 SE 280 S 280 SE 280 SEL 300 SE 300 SEL 380 SE 380 SEC 380 SEL 420 SE 420 SEC 420 SEL 500 SE 500 SEC 500 SEL 560 SE 560 SEC 560 SEL		09.85 03.91 01.80 07.85 01.80 07.85 05.80 07.85 09.85 03.91 09.85 03.91 01.80 08.85 06.81 07.85 05.80 07.85 09.85 03.91 09.85 08.91 09.85 03.91 01.80 03.91 06.81 08.91 05.80 03.91 07.88 03.91 09.85 08.91 09.85 03.91	13.0460-3804.2 13.0460-0029.2 13.0460-0912.2 24.8190-0401.2	603804 610029 610912 620401	- ASR + ASR	4	21035 15,0 Belagsatz-Zubehör Belagsatz-Zubehör Warnkontakt L=95mm	ATE ATE BDX
	260 SE 280 S 280 SE 280 SEL 300 SE 300 SEL 380 SE 380 SEC 380 SEL 420 SE 420 SEC 420 SEL 500 SE 500 SEC 500 SEL 560 SE 560 SEC 560 SEL		09.85 03.91 01.80 07.85 01.80 07.85 05.80 07.85 09.85 03.91 09.85 03.91 01.80 08.85 06.81 07.85 05.80 07.85 09.85 03.91 09.85 08.91 09.85 03.91 01.80 03.91 06.81 08.91 05.80 03.91 07.88 03.91 09.85 08.91 09.85 03.91	24.0110-0185.1	410185			279 10,0 8,3 +S +B	
	500 SE 500 SEC 500 SEL 560 SE 560 SEC 560 SEL		01.80 03.91 06.81 08.91 05.80 03.91 07.88 03.91 09.85 08.91 09.85 03.91	24.0110-0185.1	410185			279 10,0 8,3 +S +B	
	260 SE 280 S 280 SE 280 SEL		09.85 03.91 01.80 07.85 01.80 07.85 05.80 07.85	83.7704-0281.3	330804	2		L=280	

										
MERCEDES BENZ (W126) 260 SE-560 SEC (80-91)										
	300 SE			09.85	03.91	83.7704-0281.3	330804	2	L=280	
	300 SEL			09.85	03.91					
	380 SE			01.80	08.85					
	380 SEC			06.81	07.85					
	380 SEL			05.80	07.85					
	420 SE			09.85	03.91					
	420 SEC			09.85	08.91					
	420 SEL			09.85	03.91					
	500 SE			01.80	03.91					
	500 SEC			06.81	08.91					
500 SEL			05.80	03.91						
560 SE			07.88	03.91						
560 SEC			09.85	08.91						
560 SEL			09.85	03.91						
	260 SE			09.85	03.91	03.0137-0128.2	650128		160 x 25 160 x 25 /Zub Bremsbacken-Zubehör	
	280 S			01.80	07.85					
	280 SE			01.80	07.85					
	280 SEL			05.80	07.85					
	300 SE			09.85	03.91					
	300 SEL			09.85	03.91					
	380 SE			01.80	08.85					
	380 SEC			06.81	07.85					
	380 SEL			05.80	07.85					
	420 SE			09.85	03.91					
	420 SEC			09.85	08.91					
	420 SEL			09.85	03.91					
	500 SE			01.80	03.91					
	500 SEC			06.81	08.91					
	500 SEL			05.80	03.91					
	560 SE			07.88	03.91					
	560 SEC			09.85	08.91					
	560 SEL			09.85	03.91					
	260 SE			09.85	03.91	24.3727-0416.2	580416	<input type="checkbox"/>	L=1088	
	280 S			01.80	07.85					
	280 SE			01.80	07.85					
	280 SEL			05.80	07.85					
	300 SE			09.85	03.91					
	300 SEL			09.85	03.91					
	380 SE			01.80	08.85					
	380 SEC			06.81	07.85					
	380 SEL			05.80	07.85					
	420 SE			09.85	03.91					
	420 SEC			09.85	08.91					
	420 SEL			09.85	03.91					
	280 S		049604	01.80		24.2419-0901.3	030041		Gz 19,05	
	280 SE		049604	01.80						
	280 SEL		049604	05.80						
	260 SE			09.85	03.91	24.2419-0935.3	030061		Gz 19,05	
	280 S	049605			07.85					
	280 SE	049605			07.85					
	280 SEL	049605			07.85					
	300 SE			09.85	03.91					
300 SEL			09.85	03.91						
	280 S			01.80	07.85	03.2523-0811.3	040019		Nz 23,81	
	280 SE			01.80	07.85					
	280 SEL			05.80	07.85					
	260 SE			09.85	03.91	03.2523-1210.3	040021		Nz 23,81	
	300 SE			09.85	03.91					
	300 SEL			09.85	03.91					
MERCEDES BENZ (W128) 220 SE (58-60)										
	220 SE			01.58	12.60	03.3126-0505.3	010294		Hz 26,99	ATE
	220 SE			01.58	12.60	03.3508-3600.3	310030		Behälter	
MERCEDES BENZ (W180) 220 S/SE (56-59)										
	220 S/SE			01.56	12.59	03.3126-0505.3	010294		Hz 26,99	ATE
	220 S/SE			01.56	12.59	03.3508-3600.3	310030		Behälter	
	220 S/SE			01.56	12.59	83.7704-0320.3	330851	2	L=320	
	220 S/SE			01.56	12.59	03.2728-2101.3	020008	<input type="checkbox"/>	Rz 28,57	
						03.2728-2201.3	020009			
						03.0402-1128.2	060027			
	220 S/SE			01.56	12.59	83.6104-0210.3	330473	<input type="checkbox"/>	L=210	
						83.6204-0220.3	330308			
									L=220	

								
MERCEDES BENZ (W180) 220 S/SE (56-59)								
	220 S/SE		01.56	12.59		03.3223-0102.3	020090	Rz 23,81
MERCEDES BENZ (W201) 190-190 E 2,6 (82-93)								
	190 E 2.3 16V 190 E 2.5 16V 190 E 2.6		07.84 09.88 04.86	08.88 05.93 05.93		03.7760-2702.4	300090	10" ATE
	190 190 D 190 D 2.5 190 D 2.5 Turbo 190 E 1.8 190 E 2.0 190 E 2.3		04.82 09.83 05.85 11.87 03.90 04.82 09.83	02.90 05.93 05.93 05.93 05.93 05.93 05.93		24.2022-1601.3	010340	Thz 22,20/17,46
	190 E 2.3 16V 190 E 2.5 16V 190 E 2.6		07.84 09.88 04.86	08.88 05.93 05.93		03.2023-0230.3	010019	Thz 23,81/19,05 ATE
	190 E 2.3 16V 190 E 2.5 16V 190 E 2.6		07.84 09.88 04.86	08.88 05.93 05.93		03.2023-0825.3	010028	Thz 23,81/19,05 ATE
	190 E 2.5 16V Evolut. 173		03.89	05.93		03.2025-0211.3	010034	Thz 25,40/19,05 ATE
	190 190 D 190 D 2.2 190 D 2.5 190 E 1.8 190 E 2.0		04.82 09.83 09.83 05.85 03.90 04.82	02.90 05.93 05.93 09.85 + USA 05.93 05.93		24.3541-1631.5 24.3541-1632.5 11.0441-5404.2 11.0101-5403.2	240413 240414 250029 260010	D=54, - Halter LUC D=54, - Halter LUC Dichtungssatz LUC Fallenbalgsatz LUC
	190 E 2.3 16V 190 E 2.5 16V		07.84 09.88	08.88 05.93		24.3541-1603.5 24.3541-1604.5 24.0101-3601.2	240037 240038 260044	D=54, - Halter LUC D=54, - Halter LUC Bremsattel-Zubehör LUC
	190 E 2.5 16V Evolut. 173	F 723281	03.89			24.9442-8003.5 24.9442-8004.5 13.0441-4214.2	230053 230054 250091	D=42/38 ATE D=42/38 ATE Dichtungssatz ATE
	190 E 2.5 16V Evolut. 173	F 723282		05.93		24.9442-8003.5 24.9442-8004.5	230053 230054	D=42/38 ATE D=42/38 ATE
	190 190 D 190 D 2.2 190 D 2.5 190 D 2.5 Turbo 190 E 1.8 190 E 2.0 190 E 2.3 190 E 2.6		04.82 09.83 09.83 05.85 11.87 03.90 04.82 09.83 04.86	02.90 05.93 05.93 09.85 + USA 05.93 05.93 05.93 05.93 05.93		13.0460-2923.2 24.8190-0402.2	602923 620402	21055 17,0 /WE/S LUC Warnkontakt L=68(150)mm
	190 E 2.3 16V 190 E 2.5 16V		07.84 09.88	08.88 05.93		13.0460-2927.2 13.0470-2927.2 24.8190-0402.2	602927 LD2927 620402	20941 19,3 /WE/S LUC 20941 19,3 /WE/S LUC Warnkontakt L=68(150)mm
	190 E 2.5 16V Evolut. 173		03.89	05.93		13.0460-4201.2 13.0460-0219.2 24.8190-0401.2	604201 610219 620401	21153 17,5 /WE ATE Belagsatz-Zubehör ATE Warnkontakt L=95mm
	190 190 D 190 D 2.2 190 D 2.5 190 E 1.8 190 E 2.0		04.82 09.83 09.83 05.85 03.90 04.82	02.90 05.93 05.93 09.85 + USA 05.93 05.93		24.0111-0137.1 13.8190-0242.1	411137 990124	262 11,0 9,0 +S +B Halterschraube
	190 D 2.5 Turbo 190 E 2.3 190 E 2.6		11.87 09.83 04.86	05.93 05.93 05.93		24.0122-0124.1 13.8190-0242.1	422124 990124	262 22,0 19,4 V L +B Halterschraube
	190 E 2.3 16V 190 E 2.5 16V		07.84 09.88	08.88 05.93		24.0122-0123.1 13.8190-0242.1	422123 990124	284 22,0 19,4 V L +S +B Halterschraube
	190 E 2.5 16V Evolut. 173		03.89	05.93		24.0128-0103.1 13.8190-0242.1	428103 990124	300 28,0 25,4 V L +B Halterschraube
	190 190 D 190 D 2.2 190 D 2.5 190 D 2.5 Turbo 190 E 1.8 190 E 2.0 190 E 2.3 190 E 2.3 16V 190 E 2.5 16V 190 E 2.5 16V Evolut. 173 190 E 2.6		04.82 09.83 09.83 05.85 11.87 03.90 04.82 09.83 07.84 09.88 03.89 04.86	02.90 05.93 05.93 09.85 + USA 05.93 05.93 05.93 05.93 08.88 05.93 05.93 05.93		24.5101-0346.3	331406	L=346
	190 190 D 190 D 2.2 190 D 2.5 190 D 2.5 Turbo 190 E 1.8 190 E 2.0 190 E 2.3 190 E 2.3 16V 190 E 2.5 16V		04.82 09.83 09.83 05.85 11.87 03.90 04.82 09.83 07.84 09.88	02.90 05.93 05.93 09.85 + USA 05.93 05.93 05.93 05.93 08.88 05.93		13.2351-8005.2 13.2351-8006.2 24.9235-8005.5 24.9235-8006.5 13.0441-3505.2	210014 210015 230023 230024 250051	D=35 ATE D=35 ATE D=35 ATE D=35 ATE Dichtungssatz ATE

									
MERCEDES BENZ (W201) 190-190 E 2,6 (82-93)									
	190 E 2.5 16V		09.88	05.93	13.2351-8005.2	210014	   	D=35	ATE
	190 E 2.6		04.86	05.93	13.2351-8006.2	210015		D=35	ATE
					24.9235-8005.5	230023		D=35	ATE
					24.9235-8006.5	230024		D=35	ATE
					13.0441-3505.2	250051		Dichtungssatz	ATE
	190 E 2.5 16V Evolut.	173	03.89	05.93	13.2381-8035.2	210037	  	D=38	ATE
					24.9238-8035.5	230025		D=38	ATE
					24.9238-8036.5	230026		D=38	ATE
					13.0441-3817.2	250071		Dichtungssatz	ATE
	190		04.82	02.90	13.0460-4030.2	604030	4	- ASR	ATE
	190 D		09.83	05.93	13.0460-3504.2	603504		+ ASR	ATE
	190 D 2.2		09.83	09.85	13.0460-0171.2	610171			ATE
	190 D 2.5		05.85	05.93	24.8190-0401.2	620401		+ ASR	ATE
	190 D 2.5 Turbo		11.87	05.93					
	190 E 1.8		03.90	05.93					
	190 E 2.0		04.82	05.93					
	190 E 2.3		09.83	05.93					
	190 E 2.3 16V		07.84	08.88					
	190 E 2.6		04.86	05.93					
	190 E 2.3 16V		07.84	08.88	13.0460-4034.2	604034		20687 15,5	ATE
	190 E 2.5 16V		09.88	05.93	13.0460-0186.2	610186		Belagsatz-Zubehör	ATE
	190 E 2.5 16V Evolut.	173	03.89	05.93	13.0460-3805.2	603805		21197 15,0 /WE	ATE
					13.0470-3805.2	LD3805		21197 15,0 /WE	ATE
					13.0460-0215.2	610215		Belagsatz-Zubehör	ATE
	190		04.82	02.90	24.0109-0120.1	409120		258 9,0 7,3 +S +B	
	190 D		09.83	05.93					
	190 D 2.2		09.83	09.85					
	190 D 2.5		05.85	05.93					
	190 D 2.5 Turbo		11.87	05.93					
	190 E 1.8		03.90	05.93					
	190 E 2.0		04.82	05.93					
	190 E 2.3		09.83	05.93					
	190 E 2.3 16V		07.84	08.88					
	190 E 2.6		04.86	05.93					
	190 E 2.5 16V Evolut.	173	03.89	05.93	24.0109-0103.1	409103		278 9,0 7,3 +B	
	190		04.82	02.90	83.7704-0281.3	330804	2	L=280	
	190 D		09.83	05.93					
	190 D 2.2		09.83	09.85					
	190 D 2.5		05.85	05.93					
	190 D 2.5 Turbo		11.87	05.93					
	190 E 1.8		03.90	05.93					
	190 E 2.0		04.82	05.93					
	190 E 2.3		09.83	05.93					
	190 E 2.3 16V		07.84	08.88					
	190 E 2.6		04.86	05.93					
	190 E 2.5 16V Evolut.	173	03.89	05.93					
	190 E 2.6		04.86	05.93					
	190		04.82	02.90	03.0137-0170.2	650170		164 x 20 /Zub	
	190 D		09.83	05.93					
	190 D 2.2		09.83	09.85					
	190 D 2.5		05.85	05.93					
	190 D 2.5 Turbo		11.87	05.93					
	190 E 1.8		03.90	05.93					
	190 E 2.0		04.82	05.93					
	190 E 2.3		09.83	05.93					
	190 E 2.3 16V		07.84	08.88					
	190 E 2.6		04.86	05.93					
	190 E 2.5 16V Evolut.	173	03.89	05.93					
	190 E 2.6		04.86	05.93					
	190		04.82	02.90	24.3727-0410.2	580410	1	L=538	
	190 D		09.83	05.93	24.3727-0409.2	580409	2	L=1060	
	190 D 2.2		09.83	09.85					
	190 D 2.5		05.85	05.93					
	190 D 2.5 Turbo		11.87	05.93					
	190 E 1.8		03.90	05.93					
	190 E 2.0		04.82	05.93					
	190 E 2.3		09.83	05.93					
	190 E 2.3 16V		07.84	08.88					
	190 E 2.6		04.86	05.93					
	190 E 2.5 16V Evolut.	173	03.89	05.93					
	190 E 2.6		04.86	05.93					
	190		04.82	02.90	24.2419-0915.3	030045		Gz 19,05	
	190 D		09.83	05.93	24.2419-1703.3	030097		Gz 19,05	
	190 D 2.2		09.83	09.85					
	190 D 2.5		05.85	05.93					
	190 D 2.5 Turbo		11.87	05.93					
	190 E 1.8		03.90	05.93					
	190 E 2.0		04.82	05.93					
	190 E 2.3		09.83	05.93					
	190 E 2.3 16V		07.84	08.88					
	190 E 2.6		04.86	05.93					
	190 E 2.5 16V Evolut.	173	03.89	05.93					
	190 E 2.6		04.86	05.93					

1) + cast iron / + ghisa / + fonte grise / + fundición de gris

2) + aluminium / + alluminio / + aluminium / + aluminio

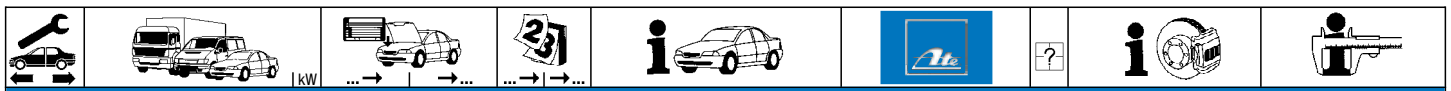

MERCEDES BENZ (W201) 190-190 E 2,6 (82-93)

	190			04.82	02.90	03.2523-1210.3	040021			Nz 23,81
	190 D			09.83	05.93					
	190 D 2.2			09.83	09.85 + (USA)					
	190 D 2.5			05.85	05.93					
	190 E 1.8			03.90	05.93					
	190 E 2.0			04.82	05.93					
	190 E 2.3			09.83	05.93					
	190 E 2.3 16V			07.84	08.88					
	190 E 2.5 16V			09.88	05.93					
	190 E 2.5 16V Evolut.	173		03.89	05.93					
190 E 2.6		F640356	04.86							
190 E 2.6		A508035	04.86							
190 D 2.5 Turbo			11.87	05.93	03.2523-1310.3	040022			Nz 23,81	
190 E 2.6		A508036		05.93						
190 E 2.6		F640357		05.93						

MERCEDES BENZ G-Klasse (W460) (79-93)

	200 GE			05.86	07.93 + (I)	03.6855-1402.4	300057			9" Tandem	ATE																																
	230 G			08.85																																							
	230 GE	031805		07.93																																							
	240 GD	031805		07.93																																							
	250 GD			08.87	07.93																																						
	280 GE	031805		07.93	- BM 460.299																																						
	300 GD	031805		07.93																																							
	230 G		040098	08.85								03.6855-1902.4	300059			9" Tandem	ATE																										
	230 GE		040098	07.93																																							
	240 GD		040098	07.93																																							
250 GD		040098	07.93																																								
280 GE		040098	07.93																																								
300 GD		040098	07.93																																								
alle Typen		035693	07.93 + (GB)																																								
	230 G		031804	02.79		24.2123-0901.3	010382			Thz 23,81																																	
	230 GE		031804	04.82																																							
	240 GD		031804	02.79																																							
	250 GD			08.87	07.93																																						
	280 GE		031804	02.79																																							
	300 GD		031804	02.79	- BM 460.325																																						
	200 GE			05.86	07.93 + (I)							03.2125-1902.3	010206			Thz 25,40	ATE																										
	230 G		031805	08.85																																							
	230 GE		031805	07.93																																							
	240 GD		031805	07.93																																							
250 GD			08.87	07.93 - BM 460.329																																							
280 GE		031805	07.93																																								
300 GD		031805	07.93	- BM 460.325																																							
230 G		040098	07.93		03.2125-2102.3	010207			Thz 25,40	ATE																																	
230 GE		040098	08.85																																								
240 GD		040098	07.93																																								
250 GD		040098	07.93																																								
280 GE		040098	07.93																																								
300 GD		040098	07.93																																								
alle Typen		035693	07.93 + (GB)																																								
	200 GE			05.86							07.93 + (I)	13.4441-8015.2	210263			D=44	ATE																										
	230 G			02.79							08.85							13.4441-8016.2	210264		D=44	ATE																					
	230 GE			04.82							07.93												13.9441-0041.2	210279		D=44	ATE																
	240 GD			02.79	07.93	13.9441-0042.2	210280		D=44	ATE																																	
	250 GD			08.87	07.93						13.0441-4408.2																	250096		Dichtungssatz	ATE												
	280 GE			02.79	07.93																																						
	300 GD			02.79	07.93																																						
	200 GE			05.86	07.93 + (I)																											13.0460-4401.2	604401			20784 18,0 /WE	ATE						
	230 G			02.79	08.85																																	13.0460-0158.2	610158			Belagsatz-Zubehör	ATE
	230 GE			04.82	07.93																																						
240 GD			02.79	07.93	24.8190-0406.2							620406	2	VA: H000248- ⁴⁾	Warnkontakt L=261mm																												
250 GD			08.87	07.93																																							
280 GE			02.79	07.93																																							
300 GD			02.79	07.93																																							
	200 GE			05.86		07.93 + (I)	24.0116-0133.1	416133			303 16,0 13,0 +S +B																																
	230 G			02.79		08.85																																					
	230 GE			04.82		07.93																																					
	240 GD			02.79		07.93																																					
	250 GD			08.87		07.93																																					
	280 GE			02.79		07.93																																					
	300 GD			02.79	07.93																																						
		200 GE		055306	05.86							24.5224-0460.3	331264	4			L=460																										
		230 G		055306	02.79																																						
		230 GE		055306	04.82																																						
240 GD			055306	02.79																																							
250 GD			055306	08.87																																							
280 GE			055306	02.79																																							
300 GD			055306	02.79																																							
		200 GE			05.86	07.93 + (I)	24.5165-0450.3	331259	2		L=450																																
		230 G			02.79	08.85																																					
		230 GE			04.82	07.93																																					
	240 GD			02.79	07.93																																						
	250 GD			08.87																																							
	280 GE			02.79	07.93 - BM 460.329																																						
	300 GD			02.79	07.93 - BM 460.325																																						

1) + two circuit brake / + impianto frenante doppio circuito / + frein à deux circuits / + freno de 2 circuitos
 2) + single circuit brake / + impianto freni circuito singolo / + frein à 1 circuit / + freno de 1 circuito
 3) FA: -H000247 / A: -H000247 / ess. AV: -H000247 / ED: -H000247
 4) FA: H000248- / A: H000248- / ess. AV: H000248- / ED: H000248-



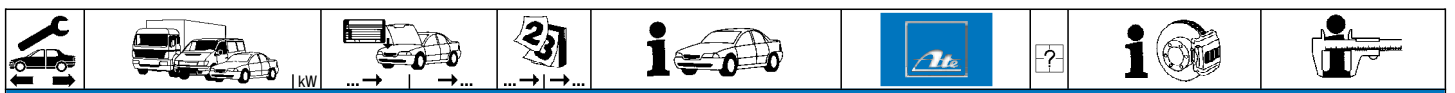

MERCEDES BENZ G-Klasse (W460) (79-93)

	200 GE 230 G 230 GE 240 GD 250 GD 280 GE 300 GD		05.86 02.79 04.82 02.79 08.87 02.79 02.79	07.93 08.85 07.93 07.93 07.93 07.93 07.93	+ ①	24.3217-1109.3	020173		Rz 17,46	
	200 GE 230 G 230 GE 240 GD 250 GD 280 GE 300 GD		05.86 02.79 04.82 02.79 08.87 02.79 02.79	07.93 08.85 07.93 07.93 07.93 07.93 07.93	+ ①	24.0226-0001.1	480050		260/261,5 x 63,5	
	200 GE 230 G 230 GE 240 GD 250 GD 280 GE 300 GD		05.86 02.79 04.82 02.79 08.87 02.79 02.79	07.93 08.85 07.93 07.93 07.93 07.93 07.93	+ ①	03.6513-0340.3	320084		BRL 1/3 (2)	ATE
	200 GE 230 G 230 GE 240 GD 250 GD 280 GE 300 GD	◀ ◀ ◀ ◀ ◀ ◀	05.86 02.79 04.82 02.79 08.87 02.79 02.79	07.93 08.85 07.93 07.93 07.93 07.93 07.93	+ ①	24.2419-0942.3	030068		Gz 19,05	
	230 G 240 GD 300 GD		02.79 02.79 02.79	08.85 07.93 07.93		03.2523-0812.3 03.0450-2311.2	040020 082311		Nz 23,81 Nz Reparatursatz	
	230 GE 250 GD		04.82 08.87	07.93 07.93		03.2523-1210.3	040021		Nz 23,81	
	280 GE		02.79	07.93		24.5901-0225.3	331288		L=225	

MERCEDES BENZ G-Klasse (W461) (90-)

	230 GE 250 GD 290 GD G 270 CDI G 290 TD G 320 CDI G 350 CDI	◀ ◀ ◀ ◀115 ◀ ◀135 ◀135	02.93 02.90 04.92 01.03 07.97 02.09 04.10			03.6855-1402.4	300057		9" Tandem	ATE
	230 GE 250 GD 290 GD G 270 CDI G 290 TD	▶ ▶ ▶ ▶115 ▶	02.93 02.90 04.92 01.03 07.97			03.6855-1902.4	300059		9" Tandem	ATE
	230 GE 250 GD 290 GD G 270 CDI G 290 TD	▶ ▶ ▶ ▶115	02.93 02.90 04.92 01.03 07.97			03.2125-2102.3	010207		THz 25,40	ATE
	230 GE 250 GD 290 GD G 270 CDI G 290 TD	115	02.93 02.90 04.92 01.03 07.97			13.9441-0041.2 13.9441-0042.2 13.0441-4408.2	210279 210280 250096	<input type="checkbox"/> <input type="checkbox"/>	D=44 D=44 Dichtungssatz	ATE ATE ATE
	230 GE 250 GD 290 GD G 270 CDI G 290 TD	115	02.93 02.90 04.92 01.03 07.97			13.0460-4401.2 13.0460-0158.2 24.8190-0406.2	604401 610158 620406	2	20784 18,0 /WE Belagsatz-Zubehör Warnkontakt L=261mm	ATE ATE
	G 320 CDI G 350 CDI	135 135	02.09 04.10			13.0460-4401.2 24.8190-0406.2	604401 620406	2	20784 18,0 /WE Warnkontakt L=261mm	ATE
	230 GE 250 GD 290 GD G 270 CDI G 290 TD	115	02.93 02.90 04.92 01.03 07.97			24.0116-0133.1	416133		303 16,0 13,0 +S +B	
	G 320 CDI G 350 CDI	135 135	02.09 04.10			24.0116-0133.1 24.0130-0217.1	416133 430217		303 16,0 13,0 +S +B 315 30,0 27,4 V L +S +B	
	230 GE 250 GD 290 GD G 290 TD		02.93 02.90 04.92 07.97			24.5224-0460.3	331264	2	L=460	
	G 270 CDI G 320 CDI	115 135	01.03 02.09			13.0460-3990.2 24.8190-0407.2	603990 620407	2	23021 18,9 /WE Warnkontakt L=84(185)mm	BOS
	G 270 CDI G 320 CDI	115 135	01.03 02.09			24.0116-0110.1	416110		272 16,0 14,0 L +S +B	



MERCEDES BENZ G-Klasse (W461) (90-)									
	230 GE 250 GD 290 GD G 270 CDI G 290 TD G 320 CDI G 350 CDI	115 135 135	02.93 02.90 04.92 01.03 07.97 02.09 04.10		83.6104-0220.3	330474	2		L=220
	230 GE 250 GD 290 GD G 290 TD G 350 CDI	135	02.93 02.90 04.92 07.97 04.10		24.3217-1109.3	020173		Rz 17,46	
	230 GE 250 GD 290 GD G 290 TD		02.93 02.90 04.92 07.97		24.0226-0001.1	480050		260/261,5 x 63,5	
	G 270 CDI G 320 CDI	115 135	01.03 02.09		03.0137-4001.2	654001		160 x 40 /Zub	
	G 270 CDI G 320 CDI G 350 CDI	115 135 135	01.03 02.09 04.10		24.3727-0476.2 24.3727-0477.2 24.3727-0476.2	580476 580477 580476	<input type="checkbox"/> <input type="checkbox"/> <input type="checkbox"/> - erhöhte Zuladung ¹⁾ <input type="checkbox"/> - erhöhte Zuladung ¹⁾	L=2230 L=2374 L=2374 L=2230	
	230 GE 250 GD 290 GD G 290 TD G 270 CDI G 320 CDI	115 135	02.93 02.90 04.92 07.97 01.03 02.09		03.6513-0340.3 03.6515-0305.3	320084 320087		BRL 1/3 (2) BRL 1/5 (2)	ATE
	230 GE 250 GD 290 GD G 290 TD		02.93 02.90 04.92 07.97		24.2419-0942.3	030068		Gz 19,05	
	230 GE 250 GD 290 GD G 290 TD		02.93 02.90 04.92 07.97		03.2523-0812.3 03.0450-2311.2	040020 082311		Nz 23,81 Nz Reparatursatz	
	250 GD 290 GD G 290 TD		02.90 04.92 07.97		03.2523-1210.3	040021		Nz 23,81	
MERCEDES BENZ S-Klasse (W140) (91-93)									
	300 SE 2.8 / S 280 300 SE 3.2 300 SEL 3.2 350 SD Turbo		08.92 04.91 04.91 03.93	06.93 06.93 06.93 06.93	03.2025-0211.3	010034		Thz 25,40/19,05	ATE
	400 SE 400 SEL 500 SE 500 SEC 500 SEL 600 SE V12 600 SEC V12 600 SEL V12	◀ A110607 ◀ A110607 ◀ A110607 ◀ A110607 ◀ A110607 ◀ A110607 ◀ A110607 ◀ A110607	06.93 06.93 06.93 06.93 06.93 06.93 06.93		03.2026-0462.3	010728		Thz 26,99/25,40	ATE
	400 SE 400 SEL 500 SE 500 SEC 500 SEL 600 SE V12 600 SEC V12 600 SEL V12	▶ A110607 ▶ A110607 ▶ A110607 ▶ A110607 ▶ A110607 ▶ A110607 ▶ A110607 ▶ A110607	06.93 06.93 06.93 06.93 06.93 06.93 06.93		03.2026-0512.3	010038		Thz 26,99/25,40	ATE
	300 SE 3.2 300 SE 3.2 300 SEL 3.2 300 SEL 3.2	A050547 A023718 A050547 A023718	04.91 04.91 04.91 04.91	+ Leichtmetallfelgen ²⁾ - Leichtmetallfelgen ³⁾ + Leichtmetallfelgen ²⁾ - Leichtmetallfelgen ³⁾	24.9571-7005.5 24.9571-7006.5	230061 230062	<input type="checkbox"/> <input type="checkbox"/>	D=57 D=57	ATE ATE
	300 SE 3.2 300 SE 3.2 300 SEL 3.2 300 SEL 3.2	A050547 A023718 A050547 A023718	04.91 04.91 04.91 04.91	+ Leichtmetallfelgen ²⁾ - Leichtmetallfelgen ³⁾ + Leichtmetallfelgen ²⁾ - Leichtmetallfelgen ³⁾	13.0460-6036.2 24.8190-0401.2	606036 620401	4	21304 18,5 /WE Warnkontakt L=95mm	ATE
	300 SE 2.8 / S 280 300 SE 3.2 300 SE 3.2 300 SEL 3.2 300 SEL 3.2 350 SD Turbo 400 SE 400 SEL 500 SE 500 SEC 500 SEL 600 SE V12 600 SEC V12 600 SEL V12	A023719 A050548 A023719 A050548	08.92 06.93 06.93 06.93 06.93 03.93 04.91 04.91 04.91 06.92 04.91 06.92 04.91	06.93 - Leichtmetallfelgen ³⁾ 06.93 + Leichtmetallfelgen ²⁾ 06.93 - Leichtmetallfelgen ³⁾ 06.93 + Leichtmetallfelgen ²⁾ 06.93 06.93 06.93 06.93 06.93 06.93 06.93 06.93	13.0460-9033.2 13.0460-0263.2 24.8190-0401.2	609033 610263 620401	4	21303 18,9 /WE Belagsatz-Zubehör Warnkontakt L=95mm	ATE

1) - increased payload / - carico utile maggiorato / - charge utile augmentée / - incremento de carga
2) + light alloy rims / + cerchi in lega / + jantes en alliage léger / + Llantas de aleación ligera
3) - light alloy rims / - cerchi in lega / - jantes en alliage léger / - Llantas de aleación ligera

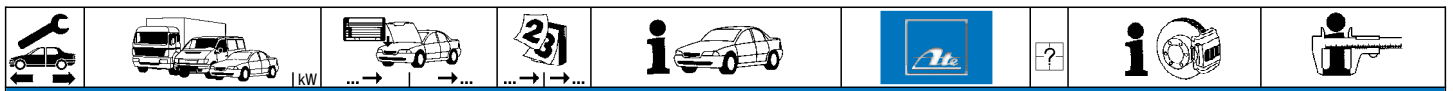

MERCEDES BENZ S-Klasse (W140) (91-93)

	300 SE 3.2	A050547	04.91	+ Leichtmetallfelgen ¹⁾	24.0128-0127.1	428127		310 28,0 25,4 V L +B	
	300 SE 3.2	A023718	04.91	- Leichtmetallfelgen ²⁾					
	300 SEL 3.2	A050547	04.91	+ Leichtmetallfelgen ¹⁾					
	300 SEL 3.2	A023718	04.91	- Leichtmetallfelgen ²⁾					
	300 SE 2.8 / S 280		08.92	06.93	24.0130-0100.1	430100		320 30,0 27,4 V L +B	
	300 SE 3.2	A023719	06.93	- Leichtmetallfelgen ²⁾					
	300 SE 3.2	A050548	06.93	+ Leichtmetallfelgen ¹⁾					
	300 SEL 3.2	A023719	06.93	- Leichtmetallfelgen ²⁾					
	300 SEL 3.2	A050548	06.93	+ Leichtmetallfelgen ¹⁾					
	350 SD Turbo		03.93	06.93					
	400 SE		04.91	06.93					
	400 SEL		04.91	06.93					
	500 SE		04.91	06.93					
	500 SEC		06.92	06.93					
	500 SEL		04.91	06.93					
	600 SE V12		04.91	06.93					
	600 SEC V12		06.92	06.93					
	600 SEL V12		04.91	06.93					
	300 SE 2.8 / S 280		08.92	06.93	24.5113-0540.3	331301	2	L=540	
	300 SE 3.2		04.91	06.93					
	300 SEL 3.2		04.91	06.93					
	350 SD Turbo		03.93	06.93					
	400 SE		04.91	06.93					
	400 SEL		04.91	06.93					
	500 SE		04.91	06.93					
	500 SEC		06.92	06.93					
	500 SEL		04.91	06.93					
	600 SE V12		04.91	06.93					
	600 SEC V12		06.92	06.93					
	600 SEL V12		04.91	06.93					
		300 SE 2.8 / S 280		08.92	06.93	13.2401-8013.2	210051		D=40 ATE
		300 SE 3.2		04.91	06.93	13.2401-8014.2	210052		D=40 ATE
300 SEL 3.2			04.91	06.93	24.9240-8013.5	230019		D=40 ATE	
350 SD Turbo			03.93	06.93	24.9240-8014.5	230020		D=40 ATE	
400 SE			04.91	06.93	13.2461-8001.2	210226		D=46 ATE	
400 SEL			04.91	06.93	24.9246-8001.5	230021		D=46 ATE	
500 SE			04.91	06.93	24.9246-8002.5	230022		D=46 ATE	
500 SEC			06.92	06.93	13.0441-4601.2	250099		Dichtungssatz ATE	
500 SEL			04.91	06.93					
600 SE V12			04.91	06.93					
600 SEC V12			06.92	06.93					
600 SEL V12			04.91	06.93					
		300 SE 2.8 / S 280		08.92	06.93	13.0460-4047.2	604047		21305 15,7 /WE ATE
		300 SE 3.2		04.91	06.93	13.0470-4047.2	LD4047		21305 15,7 /WE ATE
	300 SEL 3.2		04.91	06.93	13.0460-0239.2	610239		Belagsatz-Zubehör ATE	
	350 SD Turbo		03.93	06.93	24.8190-0401.2	620401	4 + ASR	Warnkontakt L=95mm	
	400 SE		04.91	06.93	13.0460-4047.2	604047		21305 15,7 /WE ATE	
	400 SEL		04.91	06.93	13.0470-4047.2	LD4047		21305 15,7 /WE ATE	
	500 SE		04.91	06.93	13.0460-0236.2	610236		Belagsatz-Zubehör ATE	
	500 SEC		06.92	06.93	24.8190-0401.2	620401	4 + ASR	Warnkontakt L=95mm	
	500 SEL		04.91	06.93					
	600 SE V12		04.91	06.93					
	600 SEC V12		06.92	06.93					
	600 SEL V12		04.91	06.93					
		300 SE 2.8 / S 280		08.92	06.93	24.0112-0129.1	412129		290 12,0 9,8 L
		300 SE 3.2		04.91	06.93				
300 SEL 3.2			04.91	06.93					
350 SD Turbo			03.93	06.93					
400 SE			04.91	06.93	24.0122-0133.1	422133		300 22,0 19,4 V L	
400 SEL		04.91	06.93						
500 SE		04.91	06.93						
500 SEC		06.92	06.93						
500 SEL		04.91	06.93						
600 SE V12		04.91	06.93						
600 SEC V12		06.92	06.93						
600 SEL V12		04.91	06.93						
	300 SE 2.8 / S 280		08.92	06.93	83.7704-0281.3	330804	2	L=280	
	300 SE 3.2		04.91	06.93					
	300 SEL 3.2		04.91	06.93					
	350 SD Turbo		03.93	06.93					
	400 SE		04.91	06.93					
	400 SEL		04.91	06.93					
	500 SE		04.91	06.93					
	500 SEC		06.92	06.93					
	500 SEL		04.91	06.93					
	600 SE V12		04.91	06.93					
600 SEC V12		06.92	06.93						
600 SEL V12		04.91	06.93						
	300 SE 2.8 / S 280		08.92	06.93	03.0137-0244.2	650244		164 x 25 /Zub	
	300 SE 3.2		04.91	06.93					
	300 SEL 3.2		04.91	06.93					
	350 SD Turbo		03.93	06.93					
	400 SE		04.91	06.93					
	400 SEL		04.91	06.93					
500 SE		04.91	06.93						

¹⁾ + light alloy rims / + cerchi in lega / + jantes en alliage léger / + Llantas de aleación ligera

²⁾ - light alloy rims / - cerchi in lega / - jantes en alliage léger / - Llantas de aleación ligera



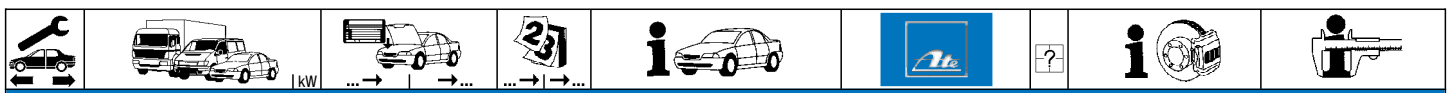

MERCEDES BENZ S-Klasse (W140) (91-93)

	500 SEC 500 SEL 600 SE V12 600 SEC V12 600 SEL V12			06.92 06.93 04.91 06.93 04.91 06.93 06.92 06.93 04.91 06.93		03.0137-0244.2	650244			164 x 25 /Zub
	300 SE 2.8 / S 280 300 SE 3.2 350 SD Turbo 400 SE 500 SE 500 SEC 600 SE V12 600 SEC V12	◀		08.92 06.93 04.91 06.93 03.93 06.93 04.91 06.93 04.91 06.93 06.92 06.93 04.91 06.93 06.92 06.93		24.3727-0462.2 24.3727-0456.2 24.3727-0455.2	580462 580456 580455	1	<input type="checkbox"/>	L=2622 L=1134 L=1109
	300 SEL 3.2 400 SEL 500 SEL 600 SEL V12	◀		04.91 06.93 04.91 06.93 04.91 06.93 04.91 06.93		24.3727-0456.2 24.3727-0455.2	580456 580455		<input type="checkbox"/>	L=1134 L=1109
	300 SE 2.8 / S 280 300 SE 3.2 350 SD Turbo 400 SE 500 SE 500 SEC 600 SE V12 600 SEC V12	▶		08.92 06.93 04.91 06.93 03.93 06.93 04.91 06.93 04.91 06.93 06.92 06.93 04.91 06.93 06.92 06.93		24.3727-0456.2 24.3727-0455.2	580456 580455		<input type="checkbox"/>	L=1134 L=1109
	300 SEL 3.2 400 SEL 500 SEL 600 SEL V12	▶		04.91 06.93 04.91 06.93 04.91 06.93 04.91 06.93		24.3727-0456.2 24.3727-0455.2	580456 580455		<input type="checkbox"/>	L=1134 L=1109
	300 SE 2.8 / S 280 300 SE 3.2 300 SEL 3.2	◀		08.92 06.93 04.91 06.93 04.91 06.93		24.2419-0915.3 24.2419-1703.3	030045 030097		+ GG ¹⁾ + ALU ²⁾	Gz 19,05 Gz 19,05
	300 SE 2.8 / S 280 300 SE 3.2 300 SEL 3.2	◀		08.92 06.93 04.91 06.93 04.91 06.93		03.2523-1310.3	040022			Nz 23,81

MERCEDES BENZ Transporter (BM 601) 207 D-210 D

	207 D 207 D 208 208 208 D 208 D 209 D 209 D 210 210 210 D 210 D		649390 614796 649390 614796 649390 614796 649390 614796 649390 614796 649390 614796	05.77 05.77 05.77 05.77 09.88 09.88 05.77 05.77 05.77 05.77 09.88 09.88	- Kombiwagen ³⁾ + Kombiwagen ⁴⁾ - Kombiwagen ³⁾ + Kombiwagen ⁴⁾ - Kombiwagen ³⁾ + Kombiwagen ⁴⁾ - Kombiwagen ³⁾ + Kombiwagen ⁴⁾ - Kombiwagen ³⁾ + Kombiwagen ⁴⁾ - Kombiwagen ³⁾ + Kombiwagen ⁴⁾	03.6850-2602.4	300049			9" ATE
	207 D 207 D 208 208 208 D 208 D 209 D 209 D 210 210 210 D 210 D	649391 614797 649391 614797 649391 614797 649391 614797 649391 614797 649391 614797			- Kombiwagen ³⁾ + Kombiwagen ⁴⁾ - Kombiwagen ³⁾ + Kombiwagen ⁴⁾ - Kombiwagen ³⁾ + Kombiwagen ⁴⁾ - Kombiwagen ³⁾ + Kombiwagen ⁴⁾ - Kombiwagen ³⁾ + Kombiwagen ⁴⁾ - Kombiwagen ³⁾ + Kombiwagen ⁴⁾	03.6855-1402.4	300057			9" Tandem ATE
	207 D 207 D 208 208 208 D 208 D 209 D 209 D 210 210 210 D 210 D		649390 / P000000 614796 / P000000 649390 / P000000 614796 / P000000 649390 / P000000 614796 / P000000 649390 / P000000 614796 / P000000 649390 / P000000 614796 / P000000 649390 / P000000 614796 / P000000	05.77 05.77 05.77 05.77 09.88 09.88 05.77 05.77 05.77 05.77 09.88 09.88	- Kombiwagen ³⁾ + Kombiwagen ⁴⁾ - Kombiwagen ³⁾ + Kombiwagen ⁴⁾ - Kombiwagen ³⁾ + Kombiwagen ⁴⁾ - Kombiwagen ³⁾ + Kombiwagen ⁴⁾ - Kombiwagen ³⁾ + Kombiwagen ⁴⁾ - Kombiwagen ³⁾ + Kombiwagen ⁴⁾	03.2123-6002.3	010184			Thz 23,81 ATE
	207 D 207 D 208 208 208 D 208 D 209 D 209 D 210 210 210 D 210 D	649391 / P000001 614797 / P000001 649391 / P000001 614797 / P000001 649391 / P000001 614797 / P000001 649391 / P000001 614797 / P000001 649391 / P000001 614797 / P000001 649391 / P000001 614797 / P000001			- Kombiwagen ³⁾ + Kombiwagen ⁴⁾ - Kombiwagen ³⁾ + Kombiwagen ⁴⁾ - Kombiwagen ³⁾ + Kombiwagen ⁴⁾ - Kombiwagen ³⁾ + Kombiwagen ⁴⁾ - Kombiwagen ³⁾ + Kombiwagen ⁴⁾ - Kombiwagen ³⁾ + Kombiwagen ⁴⁾	03.2125-1902.3	010206		- ABS	Thz 25,40 ATE

1) + cast iron / + ghisa / + fonte grise / + fundición de gris
2) + aluminium / + alluminio / + aluminium / + aluminio
3) - estate / - Station Wagon / - break / - break
4) + Estate / + Station Wagon / + Break / + Break



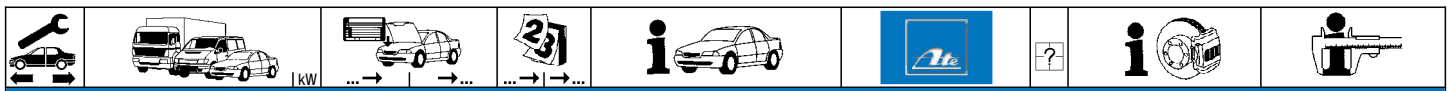

MERCEDES BENZ Transporter (BM 601) 207 D-210 D

	207 D			05.77	+ 1-Kreis-Sättel ¹⁾	13.4441-8013.2	210261		D=44 D=44 Dichtungssatz	ATE ATE ATE			
	208			05.77	+ 1-Kreis-Sättel ¹⁾	13.4441-8014.2	210262						
	208 D			09.88	+ 1-Kreis-Sättel ¹⁾	13.0441-4408.2	250096						
	209 D			05.77	+ 1-Kreis-Sättel ¹⁾								
	210			05.77	+ 1-Kreis-Sättel ¹⁾								
	210 D			09.88	+ 1-Kreis-Sättel ¹⁾				D=44 D=44 Dichtungssatz	ATE ATE ATE			
	207 D			05.77	+ 2-Kreis-Sättel ²⁾	13.4441-8015.2	210263						
	208			05.77	+ 2-Kreis-Sättel ²⁾	13.4441-8016.2	210264						
	208 D			09.88	+ 2-Kreis-Sättel ²⁾	13.0441-4408.2	250096						
	209 D			05.77	+ 2-Kreis-Sättel ²⁾								
	210			05.77	+ 2-Kreis-Sättel ²⁾				D=44 D=44 Dichtungssatz	ATE ATE ATE			
	210 D			09.88	+ 2-Kreis-Sättel ²⁾								
	207 D			05.77		13.0460-4401.2	604401				4	20784 18,0 /WE Belagsatz-Zubehör Warnkontakt L=95mm	ATE ATE
	208			05.77		13.0460-0158.2	610158						
	208 D			09.88		24.8190-0401.2	620401						
209 D			05.77										
210			05.77										
	210 D			09.88					280 16,0 13,0 +B				
	207 D			05.77		83.6204-0470.3	330312				2	L=470	
	208			05.77									
	208 D			09.88									
	209 D			05.77									
210			05.77										
	210 D			09.88					L=420				
	207 D			05.77		83.7704-0421.3	330827				2	L=420	
	208			05.77									
	208 D			09.88									
	209 D			05.77									
210			05.77										
	210 D			09.88					Rz 15,87				
	207 D			05.77		24.3215-0902.3	020153					Rz 15,87	
	208			05.77									
	208 D			09.88									
	209 D			05.77									
210			05.77										
	210 D			09.88					230/231 x 43				
	207 D			05.77		24.0223-0009.1	480039					230/231 x 43	
	208			05.77									
	208 D			09.88									
	209 D			05.77									
210			05.77										
	210 D			09.88				2	L=1798 L=1845 L=1845				
	207 D			05.77		24.3727-0420.2	580420						
	208			05.77		24.3727-0459.2	580459						
	208 D			09.88		24.3727-0460.2	580460						
	209 D			05.77									
	210			05.77					BRL 1/1 (2)	ATE			
	210 D		649390	05.77	- Kombiwagen ³⁾	03.6511-0030.3	320076						
	208										BRL 1/5 (2)	ATE	
	210	649391			- Kombiwagen ³⁾	03.6515-0305.3	320087						
	208		500000	556499		+ Kombiwagen BM 601.071/.072 ⁴⁾	03.6511-0030.3				320076	BRL 1/1 (2)	ATE
	208			240106	05.77	+ Kombiwagen BM 601.071/.072 ⁴⁾							
	210		500000	556499		+ Kombiwagen BM 601.071/.072 ⁴⁾					BRL 1/5 (2)	ATE	
	210			240106	05.77	+ Kombiwagen BM 601.071/.072 ⁴⁾							
	208		556500	649390		+ Kombiwagen BM 601.071/.072 ⁴⁾	03.6515-0304.3				320241	BRL 1/5 (2)	ATE
	208		240107	499999		+ Kombiwagen BM 601.071/.072 ⁴⁾							
	210		556500	649390		+ Kombiwagen BM 601.071/.072 ⁴⁾					BRL 1/5 (2)	ATE	
	210		240107	499999		+ Kombiwagen BM 601.071/.072 ⁴⁾							
	208		649391			+ Kombiwagen BM 601.071/.072 ⁴⁾	03.6515-0305.3				320087	BRL 1/5 (2)	ATE
	210		649391			+ Kombiwagen BM 601.071/.072 ⁴⁾							
	208			249411	05.77	+ Kombiwagen BM 601.077 ⁵⁾	03.6511-0030.3				320076	BRL 1/1 (2)	ATE
	208			248950	05.77	+ Kombiwagen BM 601.076 ⁶⁾							
	210			249411	05.77	+ Kombiwagen BM 601.077 ⁵⁾					BRL 1/5 (2)	ATE	
	210			248950	05.77	+ Kombiwagen BM 601.076 ⁶⁾							
	208		248951	649390		+ Kombiwagen BM 601.076 ⁶⁾	03.6515-0304.3				320241	BRL 1/5 (2)	ATE
	208		249412	649390		+ Kombiwagen BM 601.077 ⁵⁾							
210		248951	649390		+ Kombiwagen BM 601.076 ⁶⁾		BRL 1/5 (2)	ATE					
210		249412	649390		+ Kombiwagen BM 601.077 ⁵⁾								
208		649391			+ Kombiwagen BM 601.076/.077 ⁷⁾	03.6515-0305.3	320087	BRL 1/5 (2)	ATE				
210		649391			+ Kombiwagen BM 601.076/.077 ⁷⁾								
207 D			649390	05.77	- Kombiwagen ³⁾	03.6511-0030.3	320076	BRL 1/1 (2)	ATE				
208 D			649390	09.88	- Kombiwagen ³⁾								
207 D		649391			- Kombiwagen ³⁾	03.6515-0305.3	320087	BRL 1/5 (2)	ATE				
208 D		649391			- Kombiwagen ³⁾								
207 D		500000	556499		+ Kombiwagen BM 601.371/.372 ⁸⁾	03.6511-0030.3	320076	BRL 1/1 (2)	ATE				
210 D			240106	05.77	+ Kombiwagen BM 601.371/.372 ⁸⁾								

¹⁾ + single circuit caliper / + pinza a circuito singolo / + étriers frein à 1 circuit / + pinza de 1 circuito
²⁾ + two circuit caliper / + pinza freno a 2 circuiti / + étriers frein à 2 circuits / + pinza de 2 circuitos
³⁾ - estate / - Station Wagon / - break / - break
⁴⁾ + Estate BM 601.071/.072 / + Station Wagon BM 601.071/.072 / + Break BM 601.071/.072 / + Break BM 601.071/.072
⁵⁾ + Estate BM 601.077 / + Station Wagon BM 601.077 / + Break BM 601.077 / + Break BM 601.077
⁶⁾ + Estate BM 601.076 / + Station Wagon BM 601.076 / + Break BM 601.076 / + Break BM 601.076
⁷⁾ + Estate BM 601.076/077 / + Station Wagon BM 601.076/077 / + Break BM 601.076/077 / + Break BM 601.076/077
⁸⁾ + Estate BM 601.371/372 / + Station Wagon BM 601.371/372 / + Break BM 601.371/372 / + Break BM 601.371/372



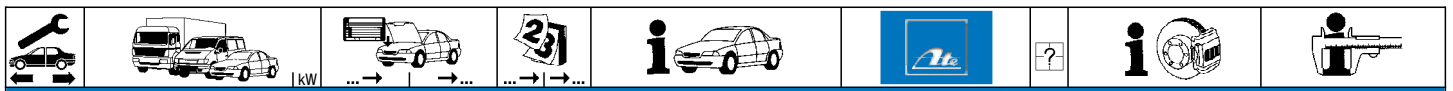

MERCEDES BENZ Transporter (BM 601) 207 D-210 D

	208 D	500000	556499		+ Kombiwagen BM 601.371/.372 ¹⁾	03.6511-0030.3	320076		BRL 1/1 (2)	ATE
	208 D		240106	09.88	+ Kombiwagen BM 601.371/.372 ¹⁾					
	207 D	556500	649390		+ Kombiwagen BM 601.371/.372 ¹⁾	03.6515-0304.3	320241		BRL 1/5 (2)	ATE
	207 D	240107	499999		+ Kombiwagen BM 601.371/.372 ¹⁾					
	208 D	556500	649390		+ Kombiwagen BM 601.371/.372 ¹⁾					
	208 D	240107	499999		+ Kombiwagen BM 601.371/.372 ¹⁾					
	207 D	649391			+ Kombiwagen BM 601.371/.372 ¹⁾					
	208 D	649391			+ Kombiwagen BM 601.371/.372 ¹⁾					
	207 D		249719	05.77	+ Kombiwagen BM 601.377 ²⁾					
	207 D		249588	05.77	+ Kombiwagen BM 601.376 ³⁾					
	208 D		249719	09.88	+ Kombiwagen BM 601.377 ²⁾					
	208 D		249588	09.88	+ Kombiwagen BM 601.376 ³⁾					
	207 D	249589	649390		+ Kombiwagen BM 601.376 ³⁾					
	207 D	249720	649390		+ Kombiwagen BM 601.377 ²⁾					
208 D	249589	649390		+ Kombiwagen BM 601.376 ³⁾						
208 D	249720	649390		+ Kombiwagen BM 601.377 ²⁾						
207 D	649391			+ Kombiwagen BM 601.376/.377 ⁴⁾						
208 D	649391			+ Kombiwagen BM 601.376/.377 ⁴⁾						
209 D		649390	05.77	- Kombiwagen ⁵⁾						
210 D		649390	09.88	- Kombiwagen ⁵⁾						
209 D	649391			- Kombiwagen ⁵⁾						
210 D	649391			- Kombiwagen ⁵⁾						
209 D		614796	05.77	+ Kombiwagen BM 601.476/.477 ⁶⁾						
210 D		614796	09.88	+ Kombiwagen BM 601.476/.477 ⁶⁾						
209 D	614797			+ Kombiwagen BM 601.476/.477 ⁶⁾						
210 D	614797			+ Kombiwagen BM 601.476/.477 ⁶⁾						
	207 D		232362	05.77		24.2419-0911.3	030043		Gz 19,05	
	208		232362	05.77						
	208 D		232362	09.88						
	210		232362	05.77						
	207 D	232363	499999							
	208	232363	499999							
	208 D	232363	499999							
	210	232363	499999							
	207 D	500000	547854							
	208	500000	547854							
	208 D	500000	547854							
	210	500000	547854							
207 D	547855									
208	547855									
208 D	547855									
210	547855									
209 D			05.77							
210 D			09.88							
	207 D			05.77		03.2523-0812.3	040020		Nz 23,81	
	208			05.77						
	208 D			09.88						
	209 D			05.77						
	210			05.77						
	210 D			09.88						
MERCEDES BENZ Transporter (BM 602) 307 D-310 D										
	307 D		649390	05.77	- Bus ⁷⁾	03.6850-2602.4	300049		9"	ATE
	307 D		625656	05.77	+ Bus ⁸⁾					
	308		649390	05.77	- Bus ⁷⁾					
	308		625656	05.77	+ Bus ⁸⁾					
	308 D		649390	09.88	- Bus ⁷⁾					
	308 D		625656	09.88	+ Bus ⁸⁾					
	309 D		649390	05.77	- Bus ⁷⁾					
	310		649390	05.77	+ Bus ⁸⁾					
	310		625656	05.77	+ Bus ⁸⁾					
	310 D		649390	09.88	+ Bus ⁸⁾					
	307 D	649391			- Bus ⁷⁾					
	307 D	625657			+ Bus ⁸⁾					
308	649391			- Bus ⁷⁾						
308	625657			+ Bus ⁸⁾						
308 D	649391			- Bus ⁷⁾						
308 D	625657			+ Bus ⁸⁾						
309 D	649391			- Bus ⁷⁾						
310	649391			- Bus ⁷⁾						
310	625657			+ Bus ⁸⁾						
310 D	649391			+ Bus ⁸⁾						
	307 D		649390	05.77	- Bus ⁷⁾	03.2123-6002.3	010184		Thz 23,81	ATE
	307 D		625656	05.77	+ Bus ⁸⁾					
	308		649390	05.77	- Bus ⁷⁾					
	308		625656	05.77	+ Bus ⁸⁾					
	308 D		649390	09.88	- Bus ⁷⁾					
	308 D		625656	09.88	+ Bus ⁸⁾					
	309 D		649390	05.77	- Bus ⁷⁾					
	310		649390	05.77	+ Bus ⁸⁾					
	310		625656	05.77	+ Bus ⁸⁾					
	310 D		649390	09.88	+ Bus ⁸⁾					
	307 D	649391			- Bus ⁷⁾					
	307 D	625657			+ Bus ⁸⁾					

MERCEDES BENZ Transporter (BM 602) 307 D-310 D

	307 D		649390	05.77	- Bus ⁷⁾	03.6850-2602.4	300049		9"	ATE
	307 D		625656	05.77	+ Bus ⁸⁾					
	308		649390	05.77	- Bus ⁷⁾					
	308		625656	05.77	+ Bus ⁸⁾					
	308 D		649390	09.88	- Bus ⁷⁾					
	308 D		625656	09.88	+ Bus ⁸⁾					
	309 D		649390	05.77	- Bus ⁷⁾					
	310		649390	05.77	+ Bus ⁸⁾					
	310		625656	05.77	+ Bus ⁸⁾					
	310 D		649390	09.88	+ Bus ⁸⁾					
	307 D	649391			- Bus ⁷⁾					
	307 D	625657			+ Bus ⁸⁾					
	307 D		649390	05.77	- Bus ⁷⁾	03.2123-6002.3	010184		Thz 23,81	ATE
	307 D		625656	05.77	+ Bus ⁸⁾					
	308		649390	05.77	- Bus ⁷⁾					
	308		625656	05.77	+ Bus ⁸⁾					
	308 D		649390	09.88	- Bus ⁷⁾					
	308 D		625656	09.88	+ Bus ⁸⁾					
	309 D		649390	05.77	- Bus ⁷⁾					
	310		649390	05.77	+ Bus ⁸⁾					
	310		625656	05.77	+ Bus ⁸⁾					
	310 D		649390	09.88	+ Bus ⁸⁾					
	307 D	649391			- Bus ⁷⁾					
	307 D	625657			+ Bus ⁸⁾					

¹⁾ + Estate BM 601.371/372 / + Station Wagon BM 601.371/.372 / + Break BM 601.371/.372 / + Break BM 601.371/.372
²⁾ + Estate BM 601.377 / + Station Wagon BM 601.377 / + Break BM 601.377 / + Break BM 601.377
³⁾ + Estate BM 601.376 / + Station Wagon BM 601.376 / + Break BM 601.376 / + Break BM 601.376
⁴⁾ + Estate BM 601.376/377 / + Station Wagon BM 601.376/.377 / + Break BM 601.376/.377 / + Break BM 601.376/.377
⁵⁾ - estate / - Station Wagon / - break / - break
⁶⁾ + Estate BM 601.476/477 / + Station Wagon BM 601.476/.477 / + Break BM 601.476/.477 / + Break BM 601.476/.477
⁷⁾ - bus / - autobus / - autobus/car / - autobus
⁸⁾ + bus / + autobus / + autobus/car / + autobus

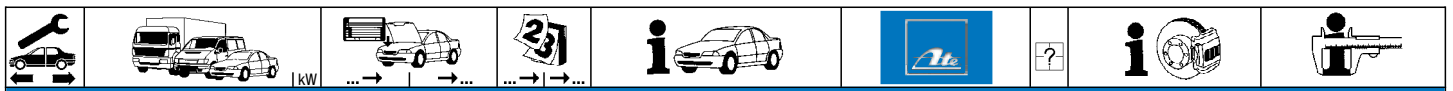

MERCEDES BENZ Transporter (BM 602) 307 D-310 D

	308 308 308 D 308 D 309 D 310 310 310 D	649391 625657 649391 625657 649391 649391 625657 649391			- Bus ¹⁾ + Bus ²⁾ - Bus ¹⁾ + Bus ²⁾ - Bus ¹⁾ + Bus ²⁾	03.2125-1902.3 010206		- ABS	Thz 25,40	ATE
	307 D 308 308 D 309 D 310 310 D		VA:A025460 VA:A025460 VA:A025460 VA:A025460 VA:A025460 VA:A025460	05.77 05.77 09.88 05.77 05.77 09.88	+ 1-Kreis-Sättel ³⁾ + 1-Kreis-Sättel ³⁾ + 1-Kreis-Sättel ³⁾ + 1-Kreis-Sättel ³⁾ + 1-Kreis-Sättel ³⁾ + 1-Kreis-Sättel ³⁾	13.4441-8013.2 13.4441-8014.2 13.0441-4408.2 210261 210262 250096	<input type="checkbox"/> <input type="checkbox"/>		D=44 D=44 Dichtungssatz	ATE ATE ATE
	307 D 308 308 D 309 D 310 310 D		VA:A025460 VA:A025460 VA:A025460 VA:A025460 VA:A025460 VA:A025460	05.77 05.77 09.88 05.77 05.77 09.88	+ 2-Kreis-Sättel ⁴⁾ + 2-Kreis-Sättel ⁴⁾ + 2-Kreis-Sättel ⁴⁾ + 2-Kreis-Sättel ⁴⁾ + 2-Kreis-Sättel ⁴⁾ + 2-Kreis-Sättel ⁴⁾	13.4441-8015.2 13.4441-8016.2 13.0441-4408.2 210263 210264 250096	<input type="checkbox"/> <input type="checkbox"/>		D=44 D=44 Dichtungssatz	ATE ATE ATE
	307 D 308 308 D 309 D 310 310 D	VA:A025461 VA:A025461 VA:A025461 VA:A025461 VA:A025461 VA:A025461				13.4441-8017.2 13.4441-8018.2 13.0441-4408.2 210265 210266 250096	<input type="checkbox"/> <input type="checkbox"/>		D=44 D=44 Dichtungssatz	ATE ATE ATE
	307 D 308 308 D 309 D 310 310 D			05.77 05.77 09.88 05.77 05.77 09.88		13.0460-4401.2 13.0460-0158.2 13.0460-0160.2 24.8190-0401.2 604401 610158 610160 620401	4	VA: -A025460 ⁵⁾ VA: A025461 - ⁶⁾	20784 18,0 /WE Belagsatz-Zubehör Belagsatz-Zubehör Warmkontakt L=95mm	ATE ATE ATE
	307 D 308 308 D 309 D 310 310 D		VA:A025460 VA:A025460 VA:A025460 VA:A025460 VA:A025460 VA:A025460	05.77 05.77 09.88 05.77 05.77 09.88		24.0116-0100.1 416100			280 16,0 13,0 +B	
	307 D 308 308 D 309 D 310 310 D	VA:A025461 VA:A025461 VA:A025461 VA:A025461 VA:A025461 VA:A025461				24.0122-0140.1 422140			280 22,0 19,0 L	
	307 D 308 308 D 309 D 310 310 D			05.77 05.77 09.88 05.77 05.77 09.88		83.6204-0470.3 330312	2		L=470	
	307 D 308 308 D 309 D 310 310 D			05.77 05.77 09.88 05.77 05.77 09.88		83.7704-0421.3 330827	2		L=420	
	307 D 308 308 D 309 D 310 310 D			05.77 05.77 09.88 05.77 05.77 09.88		24.3215-0902.3 020153			Rz 15,87	
	307 D 308 308 D 309 D 310 310 D			05.77 05.77 09.88 05.77 05.77 09.88		24.0226-0001.1 480050			260/261,5 x 63,5	
	307 D 308 308 D 309 D 310 310 D			05.77 05.77 09.88 05.77 05.77 09.88		24.3727-0420.2 24.3727-0459.2 24.3727-0460.2 580420 580459 580460	2 <input type="checkbox"/> <input type="checkbox"/>		L=1798 L=1845 L=1845	
	308 310		649390 649390	05.77 05.77	- Bus ¹⁾ - Bus ¹⁾	03.6511-0030.3 320076			BRL 1/1 (2)	ATE
	308 310	649391 649391			- Bus ¹⁾ - Bus ¹⁾	03.6513-0340.3 320084			BRL 1/3 (2)	ATE
	308 310		625656 625656	05.77 05.77	+ Bus ²⁾ + Bus ²⁾	03.6511-0030.3 320076			BRL 1/1 (2)	ATE
	308 310	625657 625657	649390 649390		+ Bus ²⁾ + Bus ²⁾	03.6515-0304.3 320241			BRL 1/5 (2)	ATE
	308 310	649391 649391			+ Bus ²⁾ + Bus ²⁾	03.6513-0340.3 320084			BRL 1/3 (2)	ATE

1) - bus / - autobus / - autobus/car / - autobús
2) + bus / + autobus / + autobus/car / + autobús
3) + single circuit caliper / + pinza a circuito singolo / + étriers frein à 1 circuit / + pinza de 1 circuito
4) + two circuit caliper / + pinza freno a 2 circuiti / + étriers frein à 2 circuits / + pinza de 2 circuitos
5) FA: -A025460 / A: -A025460 / ess.AV: -A025460 / ED: -A025460
6) FA: A025461 - / A: A025461 - / ess.AV: A025461 - / ED: A025461 -





MERCEDES BENZ Transporter (BM 602) 307 D-310 D

	307 D		649390	05.77	- Bus 1)	03.6511-0030.3	320076		BRL 1/1 (2)	ATE
	308 D		649390	09.88	- Bus 1)					
	307 D	649391			- Bus 1)	03.6513-0340.3	320084		BRL 1/3 (2)	ATE
	308 D	649391			- Bus 1)					
	307 D		625656	05.77	+ Bus 2)	03.6511-0030.3	320076		BRL 1/1 (2)	ATE
	308 D		625656	09.88	+ Bus 2)					
	307 D	625657	649390		+ Bus 2)	03.6515-0304.3	320241		BRL 1/5 (2)	ATE
	308 D	625657	649390		+ Bus 2)					
	307 D	649391			+ Bus 2)	03.6513-0340.3	320084		BRL 1/3 (2)	ATE
	308 D	649391			+ Bus 2)					
	309 D		649390	05.77		03.6511-0030.3	320076		BRL 1/1 (2)	ATE
	310 D		649390	09.88						
	309 D	649391				03.6513-0340.3	320084		BRL 1/3 (2)	ATE
	310 D	649391								
	307 D		232362	05.77		24.2419-0911.3	030043		Gz 19,05	
	308		232362	05.77						
	308 D		232362	09.88						
	310		232362	05.77						
	307 D	232363	499999			24.2419-0917.3	030047		Gz 19,05	
	308	232363	499999							
	308 D	232363	499999							
	310	232363	499999							
	307 D	500000	547854			24.2419-0911.3	030043		Gz 19,05	
	308	500000	547854							
	308 D	500000	547854							
	310	500000	547854							
	307 D	547855				24.2419-0917.3	030047		Gz 19,05	
	308	547855								
	308 D	547855								
	310	547855								
	309 D			05.77		24.2419-0917.3	030047		Gz 19,05	
	310 D			09.88						
	307 D			05.77		03.2523-0812.3	040020		Nz 23,81	
	308			05.77		03.0450-2311.2	082311		Nz Reparatursatz	
	308 D			09.88						
	309 D			05.77						
	310 D			05.77						

MERCEDES BENZ Transporter (BM 605) 206/207

	L 206 DG			01.73	04.77	83.6123-0465.3	330379	2	L=465	
	L 207			01.73	04.77					
	L 206 DG			01.73	04.77	24.3222-1733.3	020538		Rz 22,20	
	L 207			01.73	04.77					
	L 206 DG			01.73	04.77	03.3222-4401.3	020076		Rz 22,20	
	L 207			01.73	04.77					
	L 206 DG			01.73	04.77	03.6521-0012.3	320094		BRL 2/1 (3)	ATE
	L 207			01.73	04.77					
	L 206 DG			01.73	04.77	03.2525-2602.3	040029		Nz 25,40	
	L 207			01.73	04.77	03.0450-2510.2	082510		Nz Reparatursatz	
	L 206 DG			01.73	04.77	83.6103-0200.3	330219		L=200	
	L 207			01.73	04.77					

MERCEDES BENZ Transporter (BM 606) 306 DG/307

	L 306 DG			01.73	04.77	83.6123-0465.3	330379	2	L=465	
	L 306 DG Zugkopf			01.73	04.77	- BM 606.473				
	L 307			01.73	04.77					
	L 307 Zugkopf			01.73	04.77					
	L 306 DG			01.73	04.77	24.3222-1733.3	020538		Rz 22,20	
	L 306 DG Zugkopf			01.73	04.77	- BM 606.473				
	L 307			01.73	04.77					
	L 307 Zugkopf			01.73	04.77					
	L 306 DG			01.73	04.77	03.3222-4401.3	020076		Rz 22,20	
	L 307			01.73	04.77					
	L 306 DG			01.73	04.77	03.6521-0012.3	320094		BRL 2/1 (3)	ATE
	L 307			01.73	04.77					
	L 306 DG			01.73	04.77	03.2525-2602.3	040029		Nz 25,40	
	L 307			01.73	04.77	03.0450-2510.2	082510		Nz Reparatursatz	
	L 306 DG			01.73	04.77	83.6103-0200.3	330219		L=200	
	L 307			01.73	04.77					

1) - bus / - autobus / - autobus/car / - autobús
2) + bus / + autobus / + autobus/car / + autobús



MERCEDES BENZ Transporter (BM 607) 206 D

	L 206 D			01.72	12.73		83.6203-0200.3	330298	2		L=200
	L 206 D			01.72	12.73	+ 2,7 t	03.3222-4401.3	020076			Rz 22,20
	L 206 D			01.72	12.73		03.0450-2509.2	082509			Nz Reparatursatz
	L 206 D			01.72	12.73		83.6103-0200.3	330219			L=200

MERCEDES BENZ Transporter (BM 608) 306 D





























	L 306 D			01.72	12.73		83.6203-0200.3	330298	2		L=200
	L 306 D			01.72	12.73	+ 3,0/ 3,3 t	03.3222-4401.3	020076			Rz 22,20
	L 306 D			01.72	12.73		03.0450-2509.2	082509			Nz Reparatursatz
	L 306 D			01.72	12.73		83.6103-0200.3	330219			L=200

MERCEDES BENZ Transporter (BM 611) 407 D-410 D

	407 D 408 D 409 D 410 410 D	598435 598435 598435 598435 598435					03.6855-1402.4	300057			9" Tandem	ATE
	407 D 408 D 409 D 410 410 D	598435 598435 598435 598435 598435					03.2126-0512.3	010217		- ABS	THz 26,99	ATE
	407 D 408 D 409 D 410 410 D		VA:A025460 VA:A025460 VA:A025460 VA:A025460 VA:A025460	06.81 10.88 06.81 06.81 11.88	+ 1-Kreis-Sättel ¹⁾ + 1-Kreis-Sättel ¹⁾ + 1-Kreis-Sättel ¹⁾ + 1-Kreis-Sättel ¹⁾ + 1-Kreis-Sättel ¹⁾		13.4441-8013.2 13.4441-8014.2 13.0441-4408.2	210261 210262 250096	<input type="checkbox"/> <input type="checkbox"/>		D=44 D=44 Dichtungssatz	ATE ATE ATE
	407 D 408 D 409 D 410 410 D		VA:A025460 VA:A025460 VA:A025460 VA:A025460 VA:A025460	06.81 10.88 06.81 06.81 11.88	+ 2-Kreis-Sättel ²⁾ + 2-Kreis-Sättel ²⁾ + 2-Kreis-Sättel ²⁾ + 2-Kreis-Sättel ²⁾ + 2-Kreis-Sättel ²⁾		13.4441-8015.2 13.4441-8016.2 13.0441-4408.2	210263 210264 250096	<input type="checkbox"/> <input type="checkbox"/>		D=44 D=44 Dichtungssatz	ATE ATE ATE
	407 D 408 D 409 D 410 410 D	VA:A025461 VA:A025461 VA:A025461 VA:A025461 VA:A025461					13.4441-8017.2 13.4441-8018.2 13.0441-4408.2	210265 210266 250096	<input type="checkbox"/> <input type="checkbox"/>		D=44 D=44 Dichtungssatz	ATE ATE ATE
	407 D 408 D 409 D 410 410 D			06.81 10.88 06.81 06.81 11.88			13.0460-4401.2 13.0460-0158.2 13.0460-0160.2 24.8190-0401.2	604401 610158 610160 620401	4	VA: -A025460 ³⁾ VA: A025461 - ⁴⁾	20784 18,0 /WE Belagsatz-Zubehör Belagsatz-Zubehör Warnkontakt L=95mm	ATE ATE ATE
	407 D 408 D 409 D 410 410 D		VA:A025460 VA:A025460 VA:A025460 VA:A025460 VA:A025460	06.81 10.88 06.81 06.81 11.88			24.0116-0100.1	416100			280 16,0 13,0 +B	
	407 D 408 D 409 D 410 410 D	VA:A025461 VA:A025461 VA:A025461 VA:A025461 VA:A025461					24.0122-0140.1	422140			280 22,0 19,0 L	
	407 D 408 D 409 D 410 410 D			06.81 10.88 06.81 06.81 11.88			83.6204-0470.3	330312	2		L=470	
	407 D 408 D 409 D 410 410 D			06.81 10.88 06.81 06.81 11.88			83.7704-0421.3	330827	2		L=420	
	407 D 408 D 409 D 410 410 D			06.81 10.88 06.81 06.81 11.88			24.3222-1732.3	020537			Rz 22,20	

¹⁾ + single circuit caliper / + pinza a circuito singolo / + étriers frein à 1 circuit / + pinza de 1 circuito
²⁾ + two circuit caliper / + pinza freno a 2 circuiti / + étriers frein à 2 circuits / + pinza de 2 circuitos
³⁾ FA: -A025460 / A: -A025460 / ess.AV: -A025460 / ED: -A025460
⁴⁾ FA: A025461 - / A: A025461 - / ess.AV: A025461 - / ED: A025461 -



								
MERCEDES BENZ Transporter (BM 611) 407 D-410 D								
	407 D 408 D 409 D 410 410 D			06.81 10.88 06.81 06.81 11.88		03.6513-0340.3	320084	BRL 1/3 (2) ATE
	407 D 408 D 409 D 410 410 D		547854 547854 547854 556499 547854	06.81 10.88 06.81 06.81 11.88		24.2419-0911.3	030043	Gz 19,05
	407 D 408 D 409 D 410 410 D	547855 547855 547855 556500 547855				24.2419-0917.3	030047	Gz 19,05
	407 D 408 D 409 D 410 410 D			06.81 10.88 06.81 06.81 11.88		03.2523-0812.3 03.0450-2311.2	040020 082311	Nz 23,81 Nz Reparatursatz
	410		556499	06.81		83.6104-0470.3	330253	L=470
MERCEDES BENZ Transporter (BM 667) 507 D-510								
	507 D 508 D 508 DK 510			03.86 05.90 05.90 03.86		03.6855-2202.4	300061	9" Tandem ATE
	507 D 508 D 508 DK 510			03.86 05.90 05.90 03.86		03.2123-0522.3	010168	- ABS THz 23,81 ATE
	507 D 508 D 508 DK 510		VA:A025460 VA:A025460 VA:A025460 VA:A025460	03.86 05.90 05.90 03.86		13.4441-8013.2 13.4441-8014.2 13.0441-4408.2	210261 210262 250096	D=44 D=44 Dichtungssatz ATE ATE ATE
	507 D 508 D 508 DK 510	VA:A025461 VA:A025461 VA:A025461 VA:A025461			VA 730.407 ¹⁾ VA 730.407 ¹⁾	13.4441-8017.2 13.4441-8018.2 13.0441-4408.2	210265 210266 250096	D=44 D=44 Dichtungssatz ATE ATE ATE
	507 D 510			03.86 03.86	VA 730.602 ²⁾ VA 730.602 ²⁾	11.0441-6002.2	250036	Dichtungssatz ATE
	507 D 508 D 508 DK 510			03.86 05.90 05.90 03.86		13.0460-4401.2 13.0460-0158.2 13.0460-0160.2 24.8190-0401.2	604401 610158 610160 620401	VA: -A025460 ³⁾ VA: A025461 - ⁴⁾ 20784 18,0 /WE Belagsatz-Zubehör Belagsatz-Zubehör Warnkontakt L=95mm ATE ATE ATE
	507 D 508 D 508 DK 510	VA:A025461 VA:A025461 VA:A025461 VA:A025461				24.0116-0100.1	416100	280 16,0 13,0 +B
	507 D 508 D 508 DK 510			03.86 05.90 05.90 03.86		83.6204-0470.3	330312	2 L=470
	507 D 508 D 508 DK 510			03.86 05.90 05.90 03.86		83.6104-0470.3	330253	2 L=470
	507 D 508 D 508 DK 510		P012599 P012599 P012599 P012599	03.86 05.90 05.90 03.86		24.2419-0932.3	030058	Gz 19,05
	507 D 508 D 508 DK 510	P012600 P012600 P012600 P012600				24.2419-0933.3	030059	Gz 19,05
	507 D 508 D 508 DK 510			03.86 05.90 05.90 03.86		03.2523-0812.3 03.0450-2311.2	040020 082311	Nz 23,81 Nz Reparatursatz
MERCEDES BENZ Transporter (BM 668) 609 D								
	609 D 611 D			03.86 06.94		03.6855-2202.4	300061	9" Tandem ATE
	609 D 611 D			03.86 06.94	- ABS - ABS	03.2130-0102.3	010221	THz 30,00 ATE

1) FA 730.407 / A 730.407 / essieu AV 730.407 / ED 730.407
2) FA 730.602 / A 730.602 / essieu AV 730.602 / ED 730.602
3) FA: -A025460 / A: -A025460 / ess.AV: -A025460 / ED: -A025460
4) FA: A025461 - / A: A025461 - / ess.AV: A025461 - / ED: A025461 -



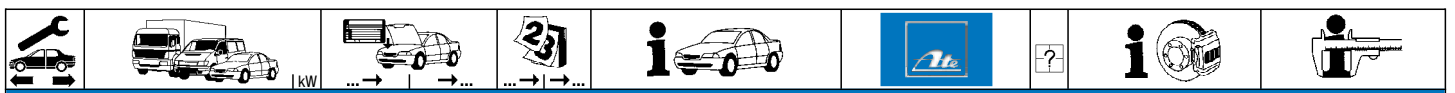

MERCEDES BENZ Transporter (BM 668) 609 D

	609 D 611 D		03.86 06.94	+ 16" Rad ¹⁾ + 16" Rad ¹⁾	11.0441-6002.2	250036		Dichtungssatz	ATE
	609 D 611 D		03.86 06.94		13.0460-6015.2 24.8190-0415.2	606015 620415	2	29835 21,7 /WE WK Satz L=239/180mm	ATE
	609 D 611 D		03.86 06.94		24.0130-0198.1	430198		304 30,0 26,0 V L	
	609 D 611 D		03.86 06.94		83.6204-0470.3	330312	2	L=470	
	609 D 611 D		03.86 06.94		83.6104-0470.3	330253	2	L=470	
	609 D 611 D		03.86 06.94		03.3230-0401.3	020115		Rz 30,16	
	609 D 611 D		03.86 06.94		24.2419-0932.3	030058		Gz 19,05	
	609 D 611 D	P012599 P012599	03.86 06.94		24.2419-0933.3	030059		Gz 19,05	
	609 D 611 D	P012600 P012600	03.86 06.94		24.2528-0907.3	040054		Nz 28,57	

MERCEDES BENZ Transporter (BM 669) 709 D/711 D

	709 D 711 D		03.86 03.86	- ABS - ABS	24.2133-0901.3	010387		THz 33,34	
	709 D 711 D		03.86 03.86	+ 16" Rad ¹⁾ + 16" Rad ¹⁾	11.0441-6002.2	250036		Dichtungssatz	ATE
	709 D 711 D		03.86 03.86	+ 17,5" Rad ²⁾ + 17,5" Rad ²⁾	11.0441-6002.2	250036		Dichtungssatz	ATE
	709 D 711 D		03.86 03.86		13.0460-6015.2 24.8190-0415.2	606015 620415	2	29835 21,7 /WE WK Satz L=239/180mm	ATE
	709 D 711 D		03.86 03.86		24.0130-0198.1	430198		304 30,0 26,0 V L	
	709 D 711 D		03.86 03.86		83.6204-0470.3	330312	2	L=470	
	709 D 711 D		03.86 03.86		83.6104-0470.3	330253	2	L=470	
	709 D 711 D		03.86 03.86		03.3231-3401.3 03.0401-2031.2	020120 052031		Rz 31,75 Rz Reparatursatz	
	709 D 711 D		03.86 03.86		24.2419-0932.3	030058		Gz 19,05	
	709 D 711 D	P012599 P012599	03.86 03.86		24.2419-0933.3	030059		Gz 19,05	
	709 D 711 D	P012600 P012600	03.86 03.86		24.2528-0907.3	040054		Nz 28,57	

MERCEDES BENZ Transporter (BM 670) 809 D-814 D

	809 D 811 D 811 DK 814 D		03.86 03.86 06.90 03.86	- ABS - ABS - ABS - ABS	24.2133-0901.3	010387		THz 33,34	
	809 D 811 D 811 DK 814 D		03.86 03.86 06.90 03.86	+ 17,5" Rad ²⁾ + 17,5" Rad ²⁾ + 17,5" Rad ²⁾ + 17,5" Rad ²⁾	11.0441-6002.2	250036		Dichtungssatz	ATE
	809 D 811 D 811 DK 814 D		03.86 03.86 06.90 03.86		13.0460-6015.2 24.8190-0415.2	606015 620415	2	29835 21,7 /WE WK Satz L=239/180mm	ATE
	809 D 811 D 811 DK 814 D		03.86 03.86 06.90 03.86		24.0130-0103.1	430103		324 30,0 26,0 V L	
	809 D 811 D 811 DK 814 D		03.86 03.86 06.90 03.86		83.6204-0470.3	330312	2	L=470	
	809 D 811 D 811 DK 814 D		03.86 03.86 06.90 03.86		83.6104-0470.3	330253	2	L=470	

¹⁾ + 16" wheel / + ruota 16" / + roue 16" / + rueda 16"

²⁾ + 17,5" wheel / + ruota 17,5" / + roue 17,5" / + rueda 17,5"





MERCEDES BENZ Transporter (BM 670) 809 D-814 D

	809 D 811 D 811 DK 814 D			03.86 03.86 06.90 03.86			03.3231-3401.3 03.0401-2031.2	020120 052031		Rz 31,75 Rz Reparatursatz
	809 D 809 DT 811 D 811 DK 814 D 814 DA		P012599 P012599 P012599 P012599 P012599 P012599	03.86 03.86 03.86 06.90 03.86 06.90			24.2419-0932.3	030058		Gz 19,05
	809 D 809 DT 811 D 811 DK 814 D 814 DA	P012600 P012600 P012600 P012600 P012600					24.2419-0933.3	030059		Gz 19,05
	809 D 809 DT 811 D 811 DK 814 D 814 DA			03.86 03.86 03.86 06.90 03.86 06.90			24.2528-0907.3	040054		Nz 28,57

MERCEDES BENZ Transporter (BM 631) MB 100 D (87-96)

	MB 100 D	021972		02.96			24.2125-1719.3	010666		THz 25,40
	MB 100 D			09.87 02.96	- Triebkopf (BM 631.349) ¹⁾		24.3481-1759.5	240339	2	D=48/48, - Halter BDX
	MB 100 D			09.87 02.96	- Triebkopf (BM 631.349) ¹⁾		13.0460-3945.2 13.0460-0918.2	603945 610918		20932 14,0 + Belagsatz-Zubehör BDX BDX
	Triebkopf			09.87 02.96	BM 631.349		13.0460-0918.2	610918		Belagsatz-Zubehör BDX
	MB 100 D			09.87 02.96	- Triebkopf (BM 631.349) ¹⁾		24.0116-0107.2	416107		239 16,0 14,5
	MB 100 D			09.87 02.96			24.5232-0388.3	330580	4	L=360
	MB 100 D			09.87 02.96			24.3225-1102.3	020318		Rz 25,40
	MB 100 D			09.87 02.96			03.0137-0245.2 03.0137-9145.2	650245 669145		254 x 57 Bremsbacken-Zubehör
	MB 100 D			09.87 02.96			24.0225-4003.1	480049		254/255 x 65
	MB 100 D			09.87 02.96			03.0420-1025.3	681025		25,40/254x57 Kit LUC
	MB 100 D			09.87 02.96	+ Radstand 2450mm /- Triebkopf ²⁾		24.3727-0413.2 24.3727-0415.2	580413 580415	1 2	L=1416 L=1438
	MB 100 D			09.87 02.96	+ Radstand 2675mm ³⁾		24.3727-0414.2 24.3727-0415.2	580414 580415	1 2	L=1647 L=1438
	Triebkopf			09.87 02.96	BM 631.349		24.3727-0415.2	580415		
	MB 100 D	099541		02.96			24.2419-1729.3	030118		Gz 19,05
	MB 100 D	099541		02.96			03.2525-2602.3	040029		Druckstange mit Gabelkopf ⁴⁾ Nz 25,40







MITSUBISHI COLT/LANCER (78-84)

	1.4 T Colt (A152A)			03.82 01.84			24.0118-0109.1	418109		242 18,0 16,4 V
	1.2 Colt (A151/155A) 1.2 Lancer F (A155A) 1.4 Colt (A152/156A) 1.4 Lancer F (A156A) 1.4 T Colt (A152A)			09.78 01.84 09.78 01.84 09.78 01.84 09.78 01.84 03.82 01.84			24.3219-1716.3	020071		Rz 19,05

MITSUBISHI COLT/LANCER Limousine (84-88)

	1.2 (C15A) 1.3 (C11A) 1.5 (C12A)			01.84 06.88 01.84 06.88 01.84 02.89			24.0113-0159.1	413159		243 12,7 11,4
	1.6 i Turbo (C13A) 1.8 D (C14A)			01.84 06.88 01.84 06.88			24.0118-0109.1	418109		242 18,0 16,4 V
	1.2 (C15A) 1.3 (C11A) 1.5 (C12A) 1.6 i Turbo (C13A) 1.8 D (C14A)			01.84 06.88 01.84 06.88 01.84 02.89 01.84 06.88 01.84 06.88			24.3219-1716.3	020071		Rz 19,05

¹⁾ - drive head (BM 631.349) / - motrice sola cabina (BM 631.349) / - tête propulsion (BM 631.349) / - grupo motriz (BM 631.349)
²⁾ + wheel base 2450 mm / + passo 2450 mm / - motr.sola cab. / + empatt.2450 mm / - tête propuls. / + dist.ejes 2450 mm / - grupo dif.
³⁾ + wheel base 2675 mm / + passo 2675 mm / + empattement 2675 mm / + distancia entre ejes 2675mm
⁴⁾ push rod with yoke / asta spinta +testa a forcella / tige poussée avec fourchette / barra de presión con horquilla

MITSUBISHI COLT/LANCER Limousine (84-88)										
	1.2 (C15A) 1.3 (C11A) 1.5 (C12A) 1.6 i Turbo (C13A) 1.8 D (C14A)			01.84 01.84 01.84 01.84 01.84	06.88 06.88 02.89 06.88 06.88		03.0137-0216.2 03.0137-9107.2	650216 669107		180 x 37 HEB Bremsbacken-Zubehör
MITSUBISHI COLT/LANCER Limousine (88-92)										
	1.2 (C65A) 1.3 (C51A/V) 1.3 (C61A) 1.5 (C52A) KAT 1.5 (C62A) 1.5 GLXi (C52A) 1.6 16V (C66A) 1.6 4x4 (C76A) 1.8 4x4 (C77A) 1.8 D (C54A) 1.8 D (C64A) 2.0 D (C67A)			06.90 06.90 06.90 06.90 06.90 06.90 06.92 06.92 06.90 06.90 06.90 06.92	05.92 05.92 10.92 05.92 10.92 05.92 10.92 10.92 05.92 05.92 05.92 10.92		13.0460-5953.2 13.0460-0233.2	605953 610233		21650 15,0 Belagsatz-Zubehör SUM
	1.6 16V (C66A) 1.8 GTi 16V (C58A) 1.8 GTi 16V (C68A) 1.8 GTi 16V (C69A)			06.92 11.89 11.89 06.92	10.92 + ABS 05.92 05.92 10.92		13.0460-5952.2 13.0460-0442.2	605952 610442		21647 16,0 +/WK Belagsatz-Zubehör SUM
	1.2 (C65A) 1.3 (C51A/V) 1.3 EL (C61A) 1.3 GL (C61A) 1.5 (C62A) 1.5 GLXi (C52A)			04.88 04.88 04.88 04.88 04.88 04.88	05.90 05.90 05.90 05.90 05.90 05.90	- elektr. Vergaser ¹⁾ - elektr. Vergaser ¹⁾ + 4 türieg ²⁾	24.0113-0159.1	413159		243 12,7 11,4
	1.3 (C51A/V) 1.3 GL (C61A) 1.3 GL (C61A) 1.5 (C62A) 1.5 GLXi (C52A) 1.8 4x4 (C77A) 1.8 D (C54A) 1.8 D (C64A)			04.88 04.88 04.88 04.88 04.88 05.89 04.88 04.88	05.90 05.90 05.90 05.90 05.90 05.90 05.90 05.90	+ elektr. Vergaser ³⁾ + elektr. Vergaser ³⁾ - elektr. Vergaser ¹⁾ + 5 türieg ⁴⁾	24.0118-0109.1	418109		242 18,0 16,4 V
	1.2 (C65A) 1.3 (C51A/V) 1.3 EL (C61A) 1.3 GL (C61A) 1.3 GLX (C61A) 1.5 (C52A) KAT 1.5 (C62A)			06.90 06.90 06.90 06.90 06.90 06.90 06.90	05.92 05.92 05.92 05.92 05.92 05.92 05.92	- elektr. Vergaser ¹⁾ + Getriebe F5M21 ⁵⁾ - elektr. Vergaser ¹⁾	24.0113-0183.1	413183		234 13,0 11,4
	1.3 (C51A/V) 1.3 (C61A) 1.3 GL (C61A) 1.5 (C52A) KAT 1.5 (C62A) 1.5 GLXi (C52A) 1.6 16V (C66A) 1.6 4x4 (C76A) 1.8 4x4 (C77A) 1.8 D (C54A) 1.8 D (C64A) 2.0 D (C67A)			06.90 06.92 06.90 06.90 06.90 06.90 06.92 06.92 06.90 06.90 06.90 06.92	05.92 10.92 05.92 05.92 05.92 05.92 10.92 10.92 05.92 05.92 05.92 10.92	+ elektr. Vergaser ³⁾ + elektr. Vergaser ³⁾ + 5 türieg ⁴⁾ - ABS	24.0118-0112.1	418112		236 18,0 16,4 V
	1.6 16V (C66A) 1.6 GTi 16V (C53/63A) 1.8 GTi 16V (C58A) 1.8 GTi 16V (C68A) 1.8 GTi 16V (C69A)			06.92 04.88 11.89 11.89 06.92	10.92 + ABS 05.90 05.92 05.92 10.92		24.0110-0238.1	410238		265 10,0 8,4
	1.2 (C65A) 1.3 (C51A/V) 1.3 (C61A) 1.5 (C52A) KAT 1.5 (C62A) 1.8 D (C54A) 1.8 D (C64A)			04.88 04.88 04.88 04.88 04.88 04.88 04.88	05.90 05.90 05.90 05.90 05.90 05.90 05.90		24.3219-1716.3	020071		Rz 19,05
	1.2 (C65A) 1.3 (C51A/V) 1.3 (C61A) 1.5 (C52A) KAT 1.5 (C62A) 1.6 16V (C66A) 1.6 4x4 (C76A) 1.8 4x4 (C77A) 1.8 D (C54A) 1.8 D (C64A) 2.0 D (C67A)			06.90 06.90 06.90 06.90 06.90 06.92 06.92 05.89 06.90 06.90 06.92	05.92 05.92 10.92 05.92 10.92 10.92 10.92 05.92 05.92 05.92 10.92	- ABS	24.3219-1752.3	020505		Rz 19,05
	1.2 (C65A) 1.3 (C51A/V) 1.3 (C61A) 1.5 (C52A) KAT 1.5 (C62A) 1.8 D (C54A) 1.8 D (C64A)			04.88 04.88 04.88 04.88 04.88 04.88 04.88	05.90 05.90 05.90 05.90 05.90 05.90 05.90		03.0137-0216.2 03.0137-9107.2	650216 669107		180 x 37 HEB Bremsbacken-Zubehör

¹⁾ - electric carburetor / - carburatore elettronico / - carburateur électrique / - carburador eléctrico

²⁾ + 4 door / + 4 porte / + 4 portes / + 4 puertas

³⁾ + electric carburetor / + carburatore elettronico / + carburateur électrique / + carburador eléctrico

⁴⁾ + 5 door / + 5 porte / + 5 portes / + 5 puertas

⁵⁾ + transmission F5M21 / + scatola cambio F5M21 / + boîte de vitesse F5M21 / + cambio F5M21

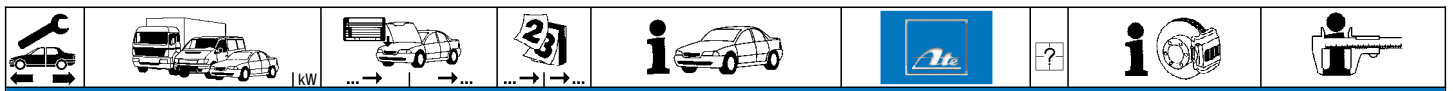

MITSUBISHI COLT/LANCER Limousine (88-92)

	1.2 (C65A)			06.90	05.92	03.0137-0255.2	650255		180 x 37	Bremsbacken-Zubehör	
	1.3 (C51A/V)			06.90	05.92						
	1.3 (C61A)			06.90	10.92						
	1.5 (C52A) KAT			06.90	05.92						
	1.5 (C62A)			06.90	10.92						
	1.6 16V (C66A)			06.92	10.92						- ABS
	1.8 D (C54A)			06.90	05.92						
	1.8 D (C64A)			06.90	05.92						
	2.0 D (C67A)			06.92	10.92						
	1.6 4x4 (C76A)			06.92	10.92						03.0137-0289.2
1.8 4x4 (C77A)			05.89	05.92	03.0137-9192.2	669192					

MITSUBISHI COLT/LANCER Limousine (92-96)

	1.3 (CA1A)			12.91	04.96	13.0460-5953.2	605953		21650	15,0	SUM	
	1.3 (CB1A)			05.92	04.96							
	1.6 (CA4A)			12.91	04.96							
	1.6 (CB4A)			05.92	04.96							
	1.6 4WD (CC4A)			12.91	04.96							
	1.6 4WD (CD4A)			05.92	04.96							
	2.0 D (CB8A)			05.92	04.96							
	1.8 16V GTi (CA5A)			12.91	04.96							13.0460-5952.2
1.8 16V GTi (CB5A)			05.92	04.96	13.0460-0442.2	610442				SUM		
	1.3 (CA1A)			12.91	04.96	24.0113-0186.1	413186		234	13,0 11,4		
	1.3 (CB1A)			05.92	04.96							
	1.3 (CA1A)			12.91	11.93	24.0118-0120.1	418120		236	18,0 16,4 V +B		
	1.3 (CB1A)			05.92	04.96							+ Option Mod. MNDEQL6 ¹⁾
	1.6 (CA4A)			12.91	04.96							+ Option Mod. SNDEQL6 ²⁾
	1.6 (CB4A)			05.92	04.96							
	1.6 4WD (CC4A)			12.91	04.96							
	1.6 4WD (CD4A)			05.92	04.96							
	2.0 D (CB8A)			05.92	04.96							
	1.6 (CA4A)			12.91	04.96							13.0460-5826.2
1.6 (CB4A)			05.92	04.96								
1.6 4WD (CC4A)			12.91	04.96								
1.6 4WD (CD4A)			05.92	11.93								
1.8 16V GTi (CA5A)			12.91	04.96								
1.8 16V GTi (CB5A)			05.92	04.96								
2.0 D (CB8A)			05.92	04.96								
1.6 (CA4A)			12.91	04.96	24.0110-0266.1	410266		236	10,0 8,4			
1.6 (CB4A)			05.92	04.96								
1.6 4WD (CC4A)			12.91	04.96								
1.6 4WD (CD4A)			05.92	11.93								
2.0 D (CB8A)			05.92	04.96								
	1.3 (CA1A)			12.91	04.96	24.3219-1752.3	020505		Rz	19,05		
	1.3 (CB1A)			05.92	04.96							
	1.3 (CA1A)			12.91	04.96	03.0137-0255.2	650255		180 x 37	Bremsbacken-Zubehör		
	1.3 (CB1A)			05.92	04.96							03.0137-9107.2
	1.6 (CA4A)			12.91	04.96	03.0137-0289.2	650289		203 x 37	Bremsbacken-Zubehör		
	1.6 (CB4A)			05.92	04.96							
	2.0 D (CB8A)			05.92	04.96							
	1.6 4WD (CC4A)			12.91	04.96							03.0137-0288.2
1.6 4WD (CD4A)			05.92	11.93								
	1.6 (CA4A)			12.91	04.96	24.0220-3017.1	480108		203/205 x	42,5		
	1.6 (CB4A)			05.92	04.96							
	2.0 D (CB8A)			05.92	04.96							

MITSUBISHI ECLIPSE I (91-95)

	2.0 16V (D22A)	110		04.91	11.95	13.0460-5952.2	605952		21647	16,0 +/WK	SUM
	2.0 16V (D22A)	110		04.91	11.95	24.0124-0142.1	424142		256	24,0 22,4 V	
	2.0 16V 4x4 (D27A)	110		04.91	11.95	24.0124-0144.1	424144		276	24,0 22,4 V	
	2.0 16V (D22A)	110		04.91	11.95						
	2.0 16V 4x4 (D27A)	110		04.91	11.95						













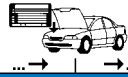













MITSUBISHI GALANT (84-87)

	1.6 (E11A)			05.84	11.87	24.0118-0109.1	418109		242	18,0 16,4 V						
	1.6 (E11A)			05.84	11.87							24.0124-0114.1	424114		266	24,0 22,4 V
	1.8 TD (E14A)			05.84	11.87											
	2.0 (E15A)			05.84	11.87											
	2.0 Turbo (E15A)			05.84	11.87											
2.4 GLS (E16A)			05.84	11.87												
	1.6 (E11A)			05.84	11.87	24.0220-3018.2	480121		203/205 x	42,5	ohne Sensorring ³⁾					
	1.8 TD (E14A)			05.84	11.87											

¹⁾ + option mod. MNDEQL6 / + opzione mod. MNDEQL6 / + option mod. MNDEQL6 / + opción mod. MNDEQL6

²⁾ + option mod. SNDEQL6 / + opzione mod. SNDEQL6 / + option mod. SNDEQL6 / + opción mod. SNDEQL6

³⁾ without sensor ring / senza sensori / sans secours ABS / sin anillo sensor ABS

										
MITSUBISHI GALANT (4-tuerig) (87-92)										
	1.8 (E32A) 1.8 TD (E34A)		06.90 06.90	10.92 10.92	- ABS	24.3541-1815.5 24.3541-1816.5	240383 240384	 	D=54, - Halter D=54, - Halter	SUM SUM
	1.6 (E31A)		06.90	10.92		13.0460-5953.2 13.0460-0233.2	605953 610233		21650 15,0 Belagsatz-Zubehör	SUM SUM
	1.8 (E32A) 1.8 TD (E34A) 2.0 (E33A) 2.0 4x4 (E38A) 2.0 4x4 (E39A)		06.90 06.90 06.90 06.90 06.90	10.92 10.92 10.92 10.92 05.91	+ SOHC	13.0460-5952.2 13.0460-0442.2	605952 610442		21647 16,0 +/WK Belagsatz-Zubehör	SUM SUM
	1.6 (E31A) 1.6 (E31A)		12.87 06.90	05.90 10.92		24.0118-0109.1 24.0118-0112.1	418109 418112	+ 13" Rad ¹⁾ + 13" Rad ¹⁾	242 18,0 16,4 V 236 18,0 16,4 V	
	1.8 (E32A) 1.8 TD (E34A) 2.0 (E33A) 2.0 4x4 (E38A) 2.0 4x4 (E39A) 2.0 4x4 (E39A)		12.87 12.87 12.87 12.88 06.88 11.89	05.90 05.90 05.90 05.90 11.89	+ SOHC	24.0124-0114.1	424114	+ 14" Rad ²⁾	266 24,0 22,4 V	
	1.8 (E32A) 1.8 TD (E34A) 2.0 (E33A) 2.0 4x4 (E38A) 2.0 4x4 (E39A)		10.89 06.90 06.90 06.90 06.90	05.90 10.92 10.92 10.92 05.91	- ABS - ABS - ABS + SOHC	24.0124-0136.1	424136	+ 14" Rad ²⁾	256 24,0 21,5 V +B	
	1.8 (E32A) 2.0 (E33A) 2.0 4x4 (E38A) 2.0 4x4 (E39A)		10.89 12.87 12.88 06.88	10.92 10.92 10.92 10.92	+ ABS	24.0110-0238.1	410238		265 10,0 8,4	
	1.6 (E31A) 1.8 (E32A) 1.8 TD (E34A)		12.88 12.88 12.88	10.92 10.92 10.92	- ABS	03.0137-0289.2 03.0137-9192.2	650289 669192		203 x 37 Bremsbacken-Zubehör	
	1.6 (E31A) 1.8 (E32A) 1.8 TD (E34A)		12.87 12.87 12.87	10.92 10.92 10.92	- ABS	24.0220-3018.2	480121	ohne Sensorring ³⁾	203/205 x 42,5	
MITSUBISHI GALANT (5-tuerig) (88-92)										
	1.8 (E32A) 1.8 TD (E34A)		06.90 06.90	10.92 10.92	- ABS	24.3541-1815.5 24.3541-1816.5	240383 240384	 	D=54, - Halter D=54, - Halter	SUM SUM
	1.8 (E32A) 1.8 TD (E34A) 2.0 (E33A) 2.0 4x4 (E38A) 2.0 4x4 (E39A)		06.90 06.90 06.90 06.90 06.90	10.92 10.92 10.92 10.92 05.91	+ SOHC	13.0460-5952.2 13.0460-0442.2	605952 610442		21647 16,0 +/WK Belagsatz-Zubehör	SUM SUM
	1.8 (E32A) 1.8 TD (E34A) 2.0 (E33A) 2.0 4x4 (E38A) 2.0 4x4 (E39A) 2.0 4x4 (E39A)		11.88 11.88 11.88 04.89 04.89 12.89	05.90 05.90 05.90 05.90 11.89 05.90	+ SOHC	24.0124-0114.1	424114		266 24,0 22,4 V	
	1.8 (E32A) 1.8 TD (E34A) 2.0 (E33A) 2.0 4x4 (E38A) 2.0 4x4 (E39A)		06.90 10.89 06.90 06.90 06.90	10.92 05.90 10.92 10.92 05.91	- ABS - ABS - ABS + SOHC	24.0124-0136.1	424136		256 24,0 21,5 V +B	
	1.8 (E32A) 2.0 (E33A) 2.0 4x4 (E38A) 2.0 4x4 (E39A)		05.90 11.88 04.89 04.89	10.92 10.92 10.92 10.92	+ ABS	24.0110-0238.1	410238		265 10,0 8,4	
	1.8 (E32A) 1.8 TD (E34A)		11.88 11.88	10.92 10.92	- ABS	03.0137-0289.2 03.0137-9192.2	650289 669192		203 x 37 Bremsbacken-Zubehör	
	1.8 (E32A) 1.8 TD (E34A)		11.88 11.88	10.92 10.92	- ABS	24.0220-3018.2	480121	ohne Sensorring ³⁾	203/205 x 42,5	
MITSUBISHI GALANT (92-96)										
	2.5 i V6 4x4 (E88A)		11.92	09.96		24.3431-1701.5 24.3431-1702.5	240437 240438	 	D=43/43, - Halter D=43/43, - Halter	
	1.8 (E52A) 2.0 (E55A) 2.0 4x4 (E75A) 2.0 i V6 (E54A) 2.0 i V6-24 (E64A) 2.0 TD (E57A)	110	11.92 11.92 11.92 11.92 11.92	09.96 09.96 09.96 09.96 09.96		13.0460-5952.2 13.0460-0442.2	605952 610442		21647 16,0 +/WK Belagsatz-Zubehör	SUM SUM
	1.8 (E52A) 2.0 (E55A) 2.0 4x4 (E75A) 2.0 i V6 (E54A) 2.0 i V6-24 (E64A) 2.0 TD (E57A)	110	11.92 11.92 11.92 11.92 11.92	09.96 09.96 09.96 09.96 09.96		24.0124-0136.1	424136		256 24,0 21,5 V +B	

¹⁾ + 13" wheel / + ruota 13" / + roue 13" / + rueda 13"

²⁾ + 14" wheel / + ruota 14" / + roue 14" / + rueda 14"

³⁾ without sensor ring / senza sensori / sans secours ABS / sin anillo sensor ABS



MITSUBISHI GALANT (92-96)												
	1.8 (E52A) 2.0 (E55A) 2.0 4x4 (E75A) 2.0 i V6 (E54A) 2.0 i V6-24 (E64A) 2.0 TD (E57A)	110			11.92 11.92 11.92 11.92 11.92	09.96 09.96 09.96 09.96 09.96	+ ABS	13.0460-5980.2 13.0460-0150.2	605980 610150	+ 14" Rad/ + 2WD ¹⁾	21706 15,5 +WK Belagsatz-Zubehör	AKE AKE
	1.8 (E52A) 2.0 (E55A) 2.0 4x4 (E75A) 2.0 i V6 (E54A) 2.0 i V6-24 (E64A) 2.0 TD (E57A)	110			11.92 11.92 11.92 11.92 11.92	09.96 09.96 09.96 09.96 09.96	+ ABS	24.0110-0240.1	410240		262 10,0 8,4	
	1.8 (E52A) 2.0 TD (E57A)				11.92 11.92	09.96 09.96	- ABS	03.0137-0289.2 03.0137-9192.2	650289 669192		203 x 37 Bremsbacken-Zubehör	
	1.8 (E52A) 2.0 (E55A) 2.0 i V6 (E54A) 2.0 i V6-24 (E64A) 2.0 TD (E57A)	110			11.92 11.92 11.92 11.92	09.96 09.96 09.96 09.96	+ ABS	03.0137-0452.2	650452		167 x 32	

MITSUBISHI L 200 (86-96)												
	1.6 (K11T) 2.0 (K12T) 2.5 D (K14T) 2.5 TD 4WD (K34T)	60 75 51 64			04.87 11.86 11.86 05.93	05.92 08.96 08.96 08.96		24.3571-1737.5 24.3571-1738.5	240387 240388		D=57, - Halter D=57, - Halter	
	1.6 (K11T) 2.0 (K12T) 2.0 4WD (K32T) 2.5 D (K14T) 2.5 D 4WD (K24T) 2.5 TD 4WD (K34T) 2.5 TD 4WD (K34T) 2.5 TD 4WD (K34T)	60 75 75 51 51 64 64 64			04.87 11.86 11.86 11.86 12.87 11.92 05.93	05.92 08.96 05.92 08.96 05.93 04.93 08.96	+ Servolenkung ²⁾	24.3431-1705.5 24.3431-1706.5	240365 240366		D=43/43, - Halter D=43/43, - Halter	SUM SUM
	2.0 4WD (K32T) 2.5 D 4WD (K24T) 2.5 TD 4WD (K34T) 2.5 TD 4WD (K34T) 2.6 4WD (K33T) 2.5 TD 4WD (K34T)	75 51 64 64 76 64			11.86 12.87 11.92 05.93 11.89 05.93	05.92 05.93 04.93 08.96 05.95 08.96	- Servolenkung ³⁾	13.0460-5940.2 13.0460-0335.2	605940 610335		21373 16,0 +WK Belagsatz-Zubehör	AKE
	2.0 4WD (K32T) 2.5 D 4WD (K24T) 2.5 TD 4WD (K34T) 2.5 TD 4WD (K34T) 2.6 4WD (K33T) 2.5 TD 4WD (K34T)	75 51 64 64 76 64			11.86 12.87 11.92 05.93 11.89 05.93	05.92 05.93 04.93 08.96 05.95 08.96	- Servolenkung ³⁾	24.0122-0175.1	422175		277 22,0 20,4 V	
	2.5 TD 4WD (K34T)	64			05.93	08.96	+ Servolenkung ²⁾	24.0124-0140.1	424140		276 24,0 22,4 V +B	
	1.6 (K11T) 2.0 (K12T) 2.0 4WD (K32T) 2.5 D (K14T) 2.5 D 4WD (K24T) 2.5 TD 4WD (K34T) 2.6 4WD (K33T)	60 75 75 51 51 64 76			04.87 11.86 11.86 11.86 12.87 11.92 11.89	05.92 08.96 05.92 08.96 05.93 08.96 05.95		03.0137-0188.2 03.0137-9105.2	650188 669105		254 x 50 Bremsbacken-Zubehör	

























MITSUBISHI L 300 (80-86)												
	1.6 (L032P) 1.6 (L062P) 2.3 D (L038/068P) 1.8 4x4 (L035G) 2.0 4x4 (L037G)				09.81 09.81 09.81 04.83 04.83	10.86 10.86 10.86 10.86 10.86		24.0120-0139.1 24.0120-0130.1	420139 420130		256 20,0 18,4 V 255 20,0 18,4 V	
	1.6 (L032P) 1.6 (L062P) 1.8 4x4 (L035G) 2.0 4x4 (L037G) 2.3 D (L038/068P)				04.83 09.81 04.83 04.83 09.81	10.86 10.86 10.86 10.86 10.86		03.0137-0188.2 03.0137-9105.2	650188 669105		254 x 50 Bremsbacken-Zubehör	

MITSUBISHI L 300 (86-94)												
	1.6 (P02V) 1.6 (P12V) 2.0 (P03V) 2.0 (P03W) 2.0 (P13V) 2.4 (P04V/W/P14V) 2.5 D (P05V/W) 2.5 D (P15V)				11.88 11.88 11.86 11.86 11.86 11.90 11.86 11.86	05.94 05.94 05.94 05.94 05.94 05.94 05.94 05.94		24.3571-1737.5 24.3571-1738.5	240387 240388		D=57, - Halter D=57, - Halter	
	1.6 (L032P) 1.6 (P02V) 1.6 (P12V) 2.0 (P03V) 2.0 (P03W) 2.0 (P13V) 2.0 4WD (P23V) 2.0 4WD (P23W) 2.4 (P04V/W/P14V) 2.4 4WD (P24V) 2.4 4WD (P24W) 2.5 D (L039P) 2.5 D (P05V/W) 2.5 D (P15V) 2.5 D 4WD (P25W/P25V)				11.88 11.88 11.88 11.86 11.86 11.86 07.88 11.86 11.90 07.88 11.86 11.88 11.86 11.86 12.87	05.94 05.94 05.94 05.94 05.94 05.94 10.92 10.92 05.94 05.94 05.94 05.94 05.94 05.94 05.94 05.94		13.0460-5940.2 13.0460-0335.2	605940 610335		21373 16,0 +WK Belagsatz-Zubehör	SUM SUM

¹⁾ + 14" wheel/ + 2WD / + ruota 14"/ + 2WD / + roue 14"/ + 2WD / + rueda 14"/ + 2WD

²⁾ + power steering / + servosterzo / + direction assistée / + dirección asistida

³⁾ - power steering / - servosterzo / - direction assistée / - dirección asistida































								
MITSUBISHI L 300 (86-94)								
	1.6 (L032P) 2.5 D (L039P)			11.86 05.94 11.86 05.94		24.0120-0139.1	420139	256 20,0 18,4 V
	1.6 (P02V) 1.6 (P12V) 2.0 (P03V) 2.0 (P03W) 2.0 (P13V) 2.4 (P04V/W/P14V) 2.5 D (P05V/W) 2.5 D (P15V)			11.88 05.94 11.88 05.94 11.86 05.94 11.86 05.94 11.86 05.94 11.90 05.94 11.86 05.94 11.86 05.94		24.0122-0155.1	422155	258 22,0 20,4 V
	2.0 4WD (P23V) 2.0 4WD (P23W) 2.4 4WD (P24V) 2.4 4WD (P24W) 2.5 D 4WD(P25W/P25V)			11.86 10.92 11.86 10.92 11.86 05.94 11.86 05.94 12.87 05.94		24.0122-0175.1	422175	277 22,0 20,4 V
	1.6 (L032P) 1.6 (P02V) 1.6 (P12V) 2.0 (P03V) 2.0 (P03W) 2.0 (P13V) 2.4 (P04V/W/P14V) 2.5 D (L039P) 2.5 D (P05V/W) 2.5 D (P15V)			11.86 05.94 11.88 05.94 11.88 05.94 11.86 05.94 11.86 05.94 11.86 05.94 11.90 05.94 11.86 05.94 11.86 05.94 11.86 05.94		03.0137-0188.2 03.0137-9105.2	650188 669105	254 x 50 Bremsbacken-Zubehör
MITSUBISHI LANCER Kombi (85-92)								
	1.5 (C12V) 1.8 4x4 (C37V) 1.8 D (C14V)			06.90 05.92 - Option Mod. LKJL6/ LNDL6 ¹⁾ 06.90 05.92 06.90 05.92		13.0460-5953.2	605953	21650 15,0 SUM
	1.5 (C12V) 1.5 (C12V) 1.8 4x4 (C37V) 1.8 D (C14V)			07.85 05.90 - Option Mod. LKJL6/ LNDL6 ¹⁾ 03.88 05.90 + Option Mod. LKJL6/ LNDL6 ²⁾ 11.86 05.90 07.85 05.90		24.0113-0159.1 24.0118-0109.1	413159 418109	243 12,7 11,4 242 18,0 16,4 V
	1.5 (C12V) 1.5 (C12V) 1.8 4x4 (C37V) 1.8 D (C14V)			06.90 05.92 - Option Mod. LKJL6/ LNDL6 ¹⁾ 06.90 05.92 + Option Mod. LKJL6/ LNDL6 ²⁾ 06.90 05.92 06.90 05.92		24.0113-0183.1 24.0118-0112.1	413183 418112	234 13,0 11,4 236 18,0 16,4 V
	1.5 (C12V) 1.8 4x4 (C37V) 1.8 D (C14V)			06.90 05.92 06.90 05.92 06.90 05.92		03.0137-0289.2 03.0137-9192.2	650289 669192	203 x 37 Bremsbacken-Zubehör
	1.5 (C12V) 1.8 D (C14V)			07.85 05.92 07.85 05.92		24.0220-3018.2	480121	ohne Sensorring ³⁾ 203/205 x 42,5
MITSUBISHI LANCER Kombi (92-96)								
	1.6 16V (CB4W) 83 2.0 D (CB8W) 50			06.92 09.96 06.92 09.96		13.0460-5953.2 13.0460-0233.2	605953 610233	21650 15,0 SUM Belagsatz-Zubehör SUM
	1.6 16V 4WD (CD4W) 83			06.92 02.95		13.0460-5952.2 13.0460-0442.2	605952 610442	21647 16,0 +/WK SUM Belagsatz-Zubehör SUM
	1.6 16V (CB4W) 83 2.0 D (CB8W) 50			06.92 09.96 06.92 09.96		24.0118-0120.1	418120	236 18,0 16,4 V +B
	1.6 16V 4WD (CD4W) 83			06.92 02.95		24.0124-0136.1	424136	256 24,0 21,5 V +B
	1.6 16V (CB4W) 83 2.0 D (CB8W) 50			06.92 09.96 + ABS 06.92 09.96 + ABS		13.0460-5826.2	605826	21872 14,5 +/WK AKE
	1.6 16V (CB4W) 83 2.0 D (CB8W) 50			06.92 09.96 + ABS 06.92 09.96 + ABS		24.0110-0266.1	410266	236 10,0 8,4
	1.6 16V (CB4W) 83 2.0 D (CB8W) 50			06.92 09.96 - ABS 06.92 09.96 - ABS		24.3219-1752.3	020505	Rz 19,05
	1.6 16V 4WD (CD4W) 83			06.92 02.95		24.3219-1716.3	020071	Rz 19,05
	1.6 16V (CB4W) 83 2.0 D (CB8W) 50			06.92 09.96 - ABS 06.92 09.96 - ABS		03.0137-0289.2 03.0137-9192.2	650289 669192	203 x 37 Bremsbacken-Zubehör
	1.6 16V 4WD (CD4W) 83			06.92 11.92		03.0137-0288.2	650288	229 x 42
	1.6 16V (CB4W) 83 2.0 D (CB8W) 50			06.92 09.96 - ABS 06.92 09.96 - ABS		24.0220-3017.1	480108	203/205 x 42,5
MITSUBISHI PAJERO (83-91)								
	2.5 TD (L044G) 2.5 TD (L049G) 2.5 TD (L144G) 2.5 TD (L149G)			05.86 10.88 05.86 05.91 11.88 05.91 11.88 05.91		13.0460-5940.2 13.0460-0335.2	605940 610335	21373 16,0 +/WK SUM Belagsatz-Zubehör SUM
	2.6 (L042G) 2.6 (L047G) 3.0 V6 (L141G) 3.0 V6 (L146G)			01.83 10.89 + Option Mod. NJL6/ VNJL6/ VNJR6 ⁴⁾ 09.84 10.89 11.88 05.91 11.88 05.91				
	2.3 TD (L043G) 2.5 TD (L044G) 2.6 (L042G)			01.83 04.86 05.86 05.87 01.83 05.87		24.0120-0130.1	420130	255 20,0 18,4 V
	2.5 TD (L049G) 2.5 TD (L149G)			06.87 05.91 11.89 05.91		24.0122-0175.1	422175	277 22,0 20,4 V

¹⁾ - option mod. LKJL6/ LNDL6 / - opzione mod. LKJL6/ LNDL6 / - option mod. LKJL6/ LNDL6 / - opción mod. LKJL6/ LNDL6



















²⁾ + option mod. LKJL6/ LNDL6 / + opzione mod. LKJL6/ LNDL6 / + option mod. LKJL6/ LNDL6 / + opción mod. LKJL6/ LNDL6

³⁾ without sensor ring / senza sensori / sans secours ABS / sin anillo sensor ABS

⁴⁾ + option mod. NJL6/ VNJL6/ VNJR6 / + opzione mod. NJL6/ VNJL6/ VNJR6 / + option mod. NJL6/ VNJL6/ VNJR6 / + opción mod. NJL6/ VNJL6/ VNJR6

								
MITSUBISHI PAJERO (83-91)								
	2.6 (L047G) 3.0 V6 (L141G) 3.0 V6 (L146G)		06.87 11.88 11.88	05.91 05.91 05.91	24.0122-0175.1	422175		277 22,0 20,4 V
	2.3 TD (L043G) 2.3 TD (L048G) 2.5 TD (L044G) 2.5 TD (L049G) 2.5 TD (L144G) 2.5 TD (L149G) 2.6 (L042G) 2.6 (L047G) 3.0 V6 (L141G) 3.0 V6 (L146G)		01.83 09.84 05.86 05.86 11.89 11.89 01.83 09.84 11.88 11.88	04.86 04.86 10.89 05.91 05.91 05.91 05.91 05.91 05.91 05.91	03.0137-0188.2 03.0137-9105.2	650188 669105		254 x 50 Bremsbacken-Zubehör
MITSUBISHI SAPPORO (87-90)								
	2.4 (E16A)	91	06.87	06.90	24.0124-0136.1	424136		256 24,0 21,5 V +B
	2.4 (E16A)	91	06.87	06.90	13.0460-5980.2	605980		21706 15,5 +/WK AKE
MITSUBISHI SIGMA (90-96)								
	3.0 V6 (F16A) 3.0 V6 (F16A)	130 151	12.90 12.90	07.91 07.91	24.0124-0144.1	424144		276 24,0 22,4 V
	3.0 V6 (F07W) 3.0 V6 (F16A) 3.0 V6 (F16A)	125 130 151	01.93 12.90 12.90	07.96 07.96 07.96	13.0460-5980.2	605980		21706 15,5 +/WK AKE
MITSUBISHI SPACE WAGON/VAN (83-91)								
	1.8 (D05V/W) 1.8 TD (D09V/W) 2.0 (D04W) 2.0 4x4 (D08W)		10.83 06.86 06.86 02.85	04.91 04.91 04.91 04.91	24.0118-0109.1 24.0124-0114.1	418109 424114		242 18,0 16,4 V 266 24,0 22,4 V
	1.8 (D05V/W) 1.8 TD (D09V/W) 2.0 (D04W)		10.83 06.86 06.86	04.91 04.91 04.91	24.0220-3018.2	480121	ohne Sensorring ¹⁾	203/205 x 42,5
MITSUBISHI TREDIA/CORDIA (82-86)								
	1.4 (A211A) 1.5 (A214A) 1.6 (A212A) 1.8 (A215A) 1.6 Turbo (A212A) 1.8 4WD (A215G) 2.0 4WD (A217G)		06.82 06.82 06.82 09.84 06.82 03.85 03.85	08.84 08.84 09.86 09.86 08.84 09.86 09.86	24.0113-0159.1 24.0118-0109.1 24.0124-0114.1	413159 418109 424114		243 12,7 11,4 242 18,0 16,4 V 266 24,0 22,4 V
NISSAN 100 NX (B13) (90-94)								
	1.6		10.90	10.94	24.3481-1726.5	240188		D=48, - Halter SUM
	1.6		10.90	10.94	13.0460-5941.2 13.0460-0336.2	605941 610336		21659 16,4 +/WK SUM Belagsatz-Zubehör SUM
	1.6 2.0 GTI	105	10.90 10.90	10.94 10.94	24.0118-0107.1 24.0126-0112.1	418107 426112		240 18,0 16,0 V +B 257 26,0 24,0 V
	2.0 GTI	105	10.90	10.94	13.0460-5983.2	605983		21713 16,5
	1.6		10.90	10.94 + ABS	24.0107-0108.1	407108		234 7,0 6,0
	1.6		10.90	10.94 - ABS	24.3215-1107.3	020352		Rz 15,87
	1.6		10.90	10.94 - ABS	03.0137-0265.2 03.0137-9165.2	650265 669165		180 x 31 Bremsbacken-Zubehör
	1.6		10.90	10.94 - ABS	24.0218-0025.1	480082		180/181 x 37,5
	1.6 2.0 GTI	105	10.90 10.90	10.94 + ABS 10.94	24.3727-1711.2	581711		L=1312
	1.6		10.90	10.94	24.3728-1703.2	591703		L=728

¹⁾ without sensor ring / senza sensori / sans secours ABS / sin anillo sensor ABS





















NISSAN 200 SX/SILVIA (S12) (83-88)							
	1.8 i Turbo 68 2.0 i 107	10.83 10.83	05.88 05.88 + Europa 1)	13.0460-5937.2 605937 13.0460-0322.2 610322		21119 17,0 +/WK Belagsatz-Zubehör	AKE AKE
NISSAN 200 SX (S13) (88-94)							
	1.8 i Turbo 124	09.88	09.91	13.0460-5933.2 605933		21725 16,8 +/WK	AKE
	1.8 i Turbo 124 1.8 i Turbo 124	09.88 10.91	09.91 03.94	24.0122-0146.1 422146 24.0122-0179.1 422179		257 22,0 20,0 V +B 280 22,0 20,0 V +B	
NISSAN 240 SX (S13) (USA) (88-93)							
	2.4 i 2.4 i	07.88 09.91	08.91 + ABS 11.93	24.0122-0146.1 422146		257 22,0 20,0 V +B	
NISSAN 300 ZX (Z31) (84-89)							
	3.0 i V6 125 3.0 i V6 Turbo	01.84 01.84	02.87 02.87	13.0460-5937.2 605937 13.0460-0322.2 610322		21119 17,0 +/WK Belagsatz-Zubehör	AKE AKE
NISSAN AXCESS (M11) (USA) (89-94)							
	2.4 i 2.4 i 4WD	01.89 01.89	07.94 07.94	24.0122-0146.1 422146		257 22,0 20,0 V +B	
	2.4 i	01.89	07.94 - Fzg. 7 Sitzplätze 2)	03.0137-0210.2 650210 03.0137-9112.2 669112		229 x 41 Bremsbacken-Zubehör	
NISSAN BLUEBIRD (U11/WU11) (83-90)							
	1.8 1.8 Turbo 2.0 2.0 D 2.0 TD	11.83 11.83 11.83 11.83 11.83	09.89 09.89 09.89 09.89 09.89	13.0460-5937.2 605937 13.0460-0322.2 610322		21119 17,0 +/WK Belagsatz-Zubehör	AKE AKE
	1.8 1.8 Turbo 2.0 2.0 D 2.0 TD	11.83 11.83 11.83 11.83 11.83	05.90 05.90 05.90 05.90 05.90	24.0122-0129.1 422129		250 22,0 20,0 V	
	2.0 2.0 D 2.0 TD	11.83 11.83 11.83	05.90 05.90 05.90	24.3220-1703.3 020391		Rz 20,64	
	1.8 2.0 2.0 D 2.0 TD	02.86 02.86 02.86 02.86	05.90 05.90 05.90 05.90	03.0137-0210.2 650210 03.0137-9112.2 669112		229 x 41 Bremsbacken-Zubehör	
	1.8 2.0 2.0 D 2.0 TD	11.83 11.83 11.83 11.83	05.90 05.90 05.90 05.90	24.0222-8025.2 480109	ohne Sensorring 3)	229/230 x 47	
NISSAN BLUEBIRD (T12) (85-90)							
	1.6 1.8 i 1.8 i Turbo 2.0 D 2.0 i	12.85 02.88 12.85 12.85 12.85	02.90 + Europa 1) 11.88 + Europa 1) 01.89 + Europa 1) 02.90 + Europa 1) 02.90 + Europa/ + Golf-Staaten 4)	13.0460-5937.2 605937 13.0460-0322.2 610322		21119 17,0 +/WK Belagsatz-Zubehör	AKE AKE
	1.6 1.8 i 1.8 i Turbo 2.0 D 2.0 i	12.85 02.88 12.85 12.85 12.85	02.90 + Europa 1) 02.90 + Europa 1) 02.90 + Europa 1) 02.90 + Europa 1) 02.90 + Europa/ + Golf-Staaten 4)	24.0122-0129.1 422129		250 22,0 20,0 V	
	1.8 i 2.0 D 2.0 i	02.88 12.85 12.85	02.90 + Europa 1) 02.90 + Europa 1) 02.90 + Europa/ + Golf-Staaten 4)	24.3220-1703.3 020391		Rz 20,64	
	1.6 1.8 i 2.0 D 2.0 i	12.85 02.88 12.85 12.85	02.90 + Europa 1) 02.90 + Europa 1) 02.90 + Europa 1) 02.90 + Europa/ + Golf-Staaten 4)	03.0137-0210.2 650210 03.0137-9112.2 669112		229 x 41 Bremsbacken-Zubehör	
	1.6 1.8 i 2.0 D 2.0 i	12.85 02.88 12.85 12.85	02.90 + Europa 1) 02.90 + Europa 1) 02.90 + Europa 1) 02.90 + Europa/ + Golf-Staaten 4)	24.0222-8025.2 480109	ohne Sensorring 3)	229/230 x 47	
NISSAN BLUEBIRD (T72) (88-90)							
	1.6 1.8 i Turbo 2.0 D 2.0 i	09.88 09.88 09.88 09.88	04.90 04.90 04.90 04.90	13.0460-5937.2 605937 13.0460-0322.2 610322		21119 17,0 +/WK Belagsatz-Zubehör	AKE AKE

1) + Europa / + Europa / + Europa / + Europa





























2) - vehicles with 7 seats / - veicoli con 7 posti a sedere / - véhicules à 7 sièges / - vehículo con 7 plazas





























3) without sensor ring / senza sensori / sans secours ABS / sin anillo sensor ABS

4) + Europa/ + Gulf States / + Europa/ + Stati del Golfo / + Europe/ + Etats Golfe Persique / + Europa/ + estad.Golfo Pérsico

















NISSAN BLUEBIRD (T72) (88-90)				
	1.6 1.8 i 16V 1.8 i Turbo 2.0 D 2.0 i	09.88 04.90 02.89 04.90 09.88 04.90 09.88 04.90 09.88 04.90	24.0122-0129.1 422129	250 22,0 20,0 V
	1.6 2.0 D 2.0 i	07.89 04.90 07.89 04.90 07.89 04.90	24.3220-1703.3 020391	Rz 20,64
	1.6 2.0 D 2.0 i	09.88 04.90 09.88 04.90 09.88 04.90	03.0137-0210.2 650210 03.0137-9112.2 669112	229 x 41 Bremsbacken-Zubehör
	1.6 2.0 D 2.0 i	09.88 04.90 09.88 04.90 09.88 04.90	24.0222-8025.2 480109	ohne Sensorring ¹⁾ 229/230 x 47
NISSAN CHERRY (N12) (82-86)				
	1.0 37 1.3 44 1.5 55 1.5 Turbo 77 1.6	04.82 07.86 04.82 07.86 04.82 07.86 04.82 05.84 06.85 07.86	13.0460-5963.2 605963	20958 16,0 AKE
	1.0 37 1.3 44 1.5 55 1.5 Turbo 77 1.6	04.82 07.86 04.82 07.86 04.82 07.86 04.82 05.84 06.85 07.86	24.0112-0115.1 412115	240 12,0 11,0
NISSAN LAUREL (C32) (84-90)				
	2.0 2.4 i 2.8 D 3.0 i V6	11.84 06.90 11.84 06.90 11.84 06.90 03.86 06.90	13.0460-5937.2 605937 13.0460-0322.2 610322	21119 17,0 +/-WK AKE Belagsatz-Zubehör AKE
	2.0 2.4 i 2.8 D	11.84 06.90 11.84 06.90 11.84 06.90	03.0137-0210.2 650210 03.0137-9112.2 669112	229 x 41 Bremsbacken-Zubehör
NISSAN MAXIMA (J30) (88-94)				
	3.0 i V6 125	12.88 09.91	24.0122-0174.1 422174	280 22,0 20,0 V
	3.0 i V6 125	12.88 09.91	24.0110-0244.1 410244	258 10,0 9,0
NISSAN MICRA/MARCH (K10) (82-92)				
	1.0 1.2	12.82 11.92 12.82 11.92	13.0460-5962.2 605962 13.0460-0319.2 610319	20957 16,0 AKE Belagsatz-Zubehör AKE
	1.0 1.2	12.82 06.87 12.82 06.87	24.0112-0121.1 412121	214 12,0 10,0
	1.0 1.2	12.88 11.92 12.88 11.92	24.0112-0139.1 412139 24.0115-0106.1 415106	214 12,0 10,0 214 15,0 13,0 V
	1.0 1.2	12.82 11.92 12.82 11.92	24.3215-1107.3 020352	Rz 15,87
	1.0 1.2	12.82 11.92 12.82 11.92	03.0137-9111.2 669111	Bremsbacken-Zubehör
	1.0 1.2 1.0 1.2	12.82 11.88 12.82 11.88 12.88 11.92 12.88 11.92	24.0218-0021.1 480067 24.0218-0022.1 480076	180/181 x 31,5 180/181 x 32,5
NISSAN PATROL (160) (79-88)				
	2.8 3.2 D 3.2 TD 4.0	09.83 08.88 09.83 08.88 09.83 08.88 09.83 08.88	13.0460-5960.2 605960 13.0460-0448.2 610448	20863 16,5 SUM Belagsatz-Zubehör SUM
	2.8 3.2 D 3.2 TD 4.0	11.79 08.88 11.79 08.88 11.79 08.88 11.79 08.88	24.0120-0119.1 420119	295 20,0 18,0 V
NISSAN PATROL (260) (89-95)				
	2.8 D 2.8 TD 3.0	04.89 11.95 04.89 11.95 04.89 11.95	13.0460-5960.2 605960 13.0460-0448.2 610448	20863 16,5 SUM Belagsatz-Zubehör SUM
	2.8 D 2.8 TD 3.0	04.89 11.95 04.89 11.95 04.89 11.95	24.0120-0119.1 420119	295 20,0 18,0 V

¹⁾ without sensor ring / senza sensori / sans secours ABS / sin anillo sensor ABS





















									
NISSAN PICK-UP (720) (79-85)									
	1.6 1.8 2.2 4WD 2.3 D 2.5 D 4WD		01.83 01.83 04.83 01.83 04.83	09.85 09.85 09.85 09.85 09.85	13.0460-5937.2 13.0460-0322.2	605937 610322		21119 17,0 +WK Belagsatz-Zubehör	AKE AKE
	2.2 4WD 2.5 D 4WD		04.83 04.83	09.85 09.85	24.0122-0180.1	422180		267 22,0 20,0 V	
NISSAN PRAIRIE (M10) (82-88)									
	2.0 i 4x4		01.86	10.88	13.0460-5937.2 13.0460-0322.2	605937 610322		21119 17,0 +WK Belagsatz-Zubehör	AKE AKE
	2.0 i 4x4		01.86	10.88	24.0122-0129.1	422129		250 22,0 20,0 V	
	2.0 i 4x4		01.86	10.88	03.0137-0210.2 03.0137-9112.2	650210 669112		229 x 41 Bremsbacken-Zubehör	
NISSAN PRAIRIE (M11) (EUROPA) (88-94)									
	2.0 2.0 4x4 2.4 i 2.4 i 4x4	72 72 98 98	10.88 10.88 04.92 04.92	03.92 03.92 07.94 07.94	13.0460-5933.2	605933		21725 16,8 +WK Belagsatz-Zubehör	AKE AKE
	2.0 2.0 4x4	72 72	10.88 10.88	03.92 03.92	24.0122-0146.1	422146		257 22,0 20,0 V +B	
	2.0	72	10.88	03.92	24.3220-1703.3	020391		Rz 20,64	
	2.0 2.0 4x4	72 72	10.88 10.88	03.92 03.92	03.0137-0210.2 03.0137-9112.2	650210 669112		229 x 41 Bremsbacken-Zubehör	
NISSAN PRIMERA (P10E) Limousine (90-96)									
	1.6 1.6 i 2.0 D		06.90 05.93 06.90	01.96 01.96 04.93	13.0460-5949.2 13.0460-0440.2	605949 610440		21280 16,0 Belagsatz-Zubehör	AKE AKE
	1.6 1.6 i 2.0 D 2.0 i 16V 2.0 i 16V 4x4		05.93 05.93 05.93 06.90 06.90	01.96 01.96 01.96 01.96 06.96	13.0460-5950.2	605950		21546 16,7	LUC
	1.6 1.6 i 2.0 D		06.90 05.93 06.90	01.96 01.96 04.93	24.0120-0152.1	420152		242 20,0 18,0 V	
	1.6 1.6 i 2.0 D 2.0 i 16V 2.0 i 16V 4x4		05.93 05.93 05.93 06.90 06.90	01.96 01.96 01.96 01.96 06.96	24.0122-0146.1	422146		257 22,0 20,0 V +B	
	1.6 1.6 i 2.0 D 2.0 i 16V 2.0 i 16V 4x4		05.93 05.93 05.93 06.90 09.94	01.96 01.96 01.96 01.96 06.96	24.3344-1701.5 24.3344-1702.5 24.0101-3401.2	240087 240088 260043	<input type="checkbox"/> <input type="checkbox"/>	D=34, - Halter D=34, - Halter Bremsmittel-Zubehör	LUC LUC LUC
	1.6 1.6 i 2.0 D 2.0 i 16V 2.0 i 16V 4x4		05.93 05.93 05.93 06.90 06.90	01.96 01.96 01.96 01.96 06.96	13.0460-5986.2	605986		21545 14,9	LUC
	1.6 1.6 i 2.0 D 2.0 i 16V 2.0 i 16V 4x4		05.93 05.93 05.93 06.90 06.90	01.96 01.96 01.96 01.96 06.96	24.0110-0215.1	410215		258 10,0 9,0 +B	
	1.6 1.6 i		06.90 05.93	08.94 08.94	24.3220-1625.3	020377	<input type="checkbox"/>	RzR 20,64	
	1.6 1.6 i 2.0 D		06.90 05.93 06.90	01.96 01.96 04.93	03.0137-0276.2 03.0137-9181.2	650276 669181		203 x 39 Bremsbacken-Zubehör	
	1.6 1.6 i 2.0 D		05.93 05.93 05.93	01.96 01.96 01.96	24.3727-1709.2 24.3727-1708.2	581709 581708	<input type="checkbox"/> <input type="checkbox"/>	L=1516 L=1491	
	2.0 i 16V		06.90	01.96	24.3728-1706.2	591706		L=717	

								
NISSAN PULSAR (USA) (83-86)								
	1.6		01.83	12.86	24.0112-0115.1	412115		240 12,0 11,0
NISSAN SENTRA (USA) (82-86)								
	1.5 1.6		01.82 01.82	12.86 12.86	24.0112-0115.1	412115		240 12,0 11,0
NISSAN STANZA (T12) (84-86)								
	2.0		12.84	12.86 + Europa ¹⁾	13.0460-5937.2 13.0460-0322.2	605937 610322		21119 17,0 +/WK Belagsatz-Zubehör AKE AKE
	2.0		12.84	12.86 + Europa ¹⁾	24.0122-0129.1	422129		250 22,0 20,0 V
	2.0		12.84	12.86 + Europa ¹⁾	03.0137-0210.2 03.0137-9112.2	650210 669112		229 x 41 Bremsbacken-Zubehör
NISSAN SUNNY (B11) (82-88)								
	1.3 1.5 1.6		03.82 03.82 03.82	05.88 05.88 05.88	13.0460-5963.2	605963		20958 16,0 AKE
	1.3 1.5 1.6		03.82 03.82 03.82	05.88 05.88 05.88	24.0112-0115.1	412115		240 12,0 11,0
NISSAN SUNNY (B12) Coupe (86-90)								
	1.5 1.6		06.86 06.86	09.88 12.90	13.0460-5963.2	605963		20958 16,0 AKE
	1.5 1.6 1.6 i 1.7 D 1.6 i		06.86 06.86 02.87 06.86 02.87	09.88 12.90 - DOHC 12.90 + DOHC	24.0112-0123.1	412123		240 12,0 11,0
					24.0118-0107.1	418107		240 18,0 16,0 V +B
NISSAN SUNNY (B12) Kombi (86-90)								
	1.5 1.6 i 1.6 i 4x4 1.7 D		06.86 06.86 06.86 06.86	09.88 12.90 12.90 12.90	24.0118-0107.1	418107		240 18,0 16,0 V +B
	1.6 i 4x4		06.86	12.90	03.0137-0210.2 03.0137-9112.2	650210 669112		229 x 41 Bremsbacken-Zubehör
NISSAN SUNNY (B310) (78-82)								
	1.2 1.4 1.5		09.78 09.78 09.78	05.82 05.82 05.82	24.3220-1703.3	020391		Rz 20,64
NISSAN SUNNY (N13) (86-90)								
	1.0 1.3 1.4 1.5 1.6 i		06.86 06.86 10.88 06.86 06.86	12.90 12.90 12.90 09.88 12.90 - DOHC	13.0460-5963.2	605963		20958 16,0 AKE
	1.0 1.3 1.4 1.5 1.6 i		06.86 06.86 10.88 06.86 06.86	12.90 12.90 12.90 09.88 12.90 - DOHC	24.0112-0123.1	412123		240 12,0 11,0
	1.6 i 1.6 i 4x4 1.7 D		02.87 06.86 06.86	09.88 12.90 12.90 + DOHC	24.0118-0107.1	418107		240 18,0 16,0 V +B
	1.4		10.88	12.90	24.0107-0108.1	407108		234 7,0 6,0
	1.6 i 4x4		06.86	12.90	03.0137-0210.2 03.0137-9112.2	650210 669112		229 x 41 Bremsbacken-Zubehör
NISSAN SUNNY (N14) Limousine (90-95)								
	1.4 1.6 16V 1.6 16V 4x4 2.0 D		10.90 10.90 10.90 10.90	05.95 05.95 05.95 05.95	24.3481-1726.5	240188		D=48, - Halter SUM
	1.4 1.6 16V 1.6 16V 4x4 2.0 D 2.0 16V GTI 2.0 GTI R 4x4		10.90 10.90 10.90 10.90 10.90 10.90	05.95 05.95 05.95 05.95 05.95 05.95	13.0460-5941.2 13.0460-0336.2	605941 610336		21659 16,4 +/WK Belagsatz-Zubehör SUM SUM
					13.0460-0294.2	610294		Belagsatz-Zubehör

¹⁾ + Europe / + Europa / + Europe / + Europa

NISSAN SUNNY (N14) Limousine (90-95)								
	1.4 1.6 16V 1.6 16V 4x4 2.0 D 2.0 16V GTI 2.0 GTI R 4x4			10.90 05.95 10.90 05.95 10.90 05.95 10.90 05.95 10.90 05.95 10.90 05.95		24.0118-0107.1 418107 24.0126-0112.1 426112		240 18,0 16,0 V +B 257 26,0 24,0 V
	1.4 1.6 16V 1.6 16V 4x4 2.0 D 2.0 16V GTI 2.0 GTI R 4x4			10.90 05.95 + ABS 10.90 05.95 + ABS 10.90 05.95 + ABS 10.90 05.95 + ABS 10.90 05.95 10.90 05.95		13.0460-0295.2 610295 13.0460-5983.2 605983 13.0460-0295.2 610295		Belagsatz-Zubehör 21713 16,5 Belagsatz-Zubehör
	1.4 1.6 16V 1.6 16V 4x4 2.0 D			10.90 05.95 + ABS 10.90 05.95 + ABS 10.90 05.95 + ABS 10.90 05.95 + ABS		24.0107-0108.1 407108		234 7,0 6,0
	1.4 1.6 16V 2.0 D			10.90 05.95 - ABS 10.90 05.95 - ABS 10.90 05.95 - ABS		24.3215-1107.3 020352		Rz 15,87
	1.4 1.6 16V 2.0 D 1.6 16V 4x4			10.90 05.95 - ABS 10.90 05.95 - ABS 10.90 05.95 - ABS 10.90 05.95 - ABS		03.0137-0265.2 650265 03.0137-9165.2 669165 03.0137-0210.2 650210 03.0137-9112.2 669112		180 x 31 Bremsbacken-Zubehör 229 x 41 Bremsbacken-Zubehör
	1.4 1.6 16V 2.0 D 1.6 16V 4x4			10.90 05.95 - ABS 10.90 05.95 - ABS 10.90 05.95 - ABS 10.90 05.95 - ABS		24.0218-0025.1 480082 24.0222-8021.1 480092		180/181 x 37,5 229/230 x 54,5
	1.4 1.6 16V 2.0 D 1.4 1.6 16V 2.0 16V GTI 2.0 D 1.6 16V 4x4 1.6 16V 4x4 2.0 GTI R 4x4			10.90 05.95 - ABS 10.90 05.95 - ABS 10.90 05.95 - ABS 10.90 05.95 + ABS 10.90 05.95 + ABS 10.90 05.95 + ABS 10.90 05.95 + ABS 10.90 05.95 - ABS 10.90 05.95 + ABS 10.90 05.95 10.90 05.95		24.3727-1701.2 581701 24.3727-1701.2 581701 24.3727-1711.2 581711 24.3727-1701.2 581701 24.3727-1701.2 581701 24.3727-1701.2 581701	↑ ↑ ☐ ↑ ↑ ↑	L=250 L=250 L=1312 L=250 L=250 L=250
	1.4 1.6 16V 1.6 16V 4x4			10.90 04.92 10.90 05.95 10.90 05.95		24.3728-1703.2 591703		L=728
NISSAN VANETTE (C220) (87-95)								
	1.5 2.0 D			04.87 01.95 04.87 01.95		13.0460-5937.2 605937 13.0460-0322.2 610322		21119 17,0 +WK Belagsatz-Zubehör AKE AKE
	1.5 2.0 D			04.87 01.95 04.87 01.95		24.0122-0167.1 422167		250 22,0 20,0 V
	1.5 2.0 D			04.87 01.95 04.87 01.95		24.3220-1703.3 020391		Rz 20,64
NISSAN VANETTE Bus (GC22) (86-95)								
	2.0 2.0 D 2.4 i			10.86 05.87 10.86 05.87 10.86 05.87		13.0460-5957.2 605957		21347 17,0 +WK AKE
	2.0 2.0 D 2.4 i			10.86 12.95 10.86 12.95 10.86 12.95		03.0137-0310.2 650310 03.0137-9273.2 669273		260 x 52 Bremsbacken-Zubehör
NISSAN VANETTE Kasten (GC22) (87-95)								
	1.5 2.0 D			07.87 01.95 07.87 01.95		13.0460-5937.2 605937 13.0460-0322.2 610322		21119 17,0 +WK Belagsatz-Zubehör AKE AKE
	1.5 2.0 D			07.87 01.95 07.87 01.95		24.0122-0167.1 422167		250 22,0 20,0 V
	1.5 2.0 D 1.5 2.0 D			07.87 01.95 - Fenster 1) 07.87 01.95 - Fenster 1) 07.87 01.95 + Fenster 2) 07.87 01.95 + Fenster 2)		03.0137-0210.2 650210 03.0137-9112.2 669112 03.0137-0310.2 650310 03.0137-9273.2 669273		229 x 41 Bremsbacken-Zubehör 260 x 52 Bremsbacken-Zubehör
NISSAN VIOLET/140J/160J (A10) (77-81)								
	1.4 1.6			06.77 05.81 06.77 05.81		24.3220-1703.3 020391		Rz 20,64

1) - window / - finestrino / - fenêtre / - ventana
2) + window / + finestrino / + fenêtre / + ventana

NISSAN (DATSUN) BLUEBIRD (810) (77-79)											
	1.8 1.8			10.77 10.77	12.79 12.79	- Europa/ + Limousine ¹⁾ + Europa/ + Kombiwagen ²⁾	24.3220-1703.3	020391		Rz 20,64	
NSU PRINZ 4 (61-71)											
	600			01.66	11.71	+ VA-Scheibenbremse ³⁾	03.3115-2651.3	010250		Hz 15,87	ATE
	600			01.66	11.71		13.0441-3801.2	250058		Dichtungssatz	ATE
	600			01.66	11.71		13.0460-3010.2 13.0460-0014.2	603010 610014		20009 15,0 Belagsatz-Zubehör	ATE ATE
	600			08.61	11.71		03.3219-0203.3	020037		Rz 19,05	
	600			01.66	11.71	+ VA-Scheibenbremse ³⁾	03.3215-0221.3	020013		Rz 15,87	
NSU RO 80 (67-77)											
	1.0			10.67	07.77		13.0441-4005.2	250075		Dichtungssatz	ATE
	1.0			10.67	07.77		83.7704-0320.3	330851	2	L=320	
	1.0			10.67	07.77		13.0441-3801.2	250058		Dichtungssatz	ATE
NSU TT/TTS (65-71)											
	1000 TTS 1200 TT			01.70 07.65	11.71 11.71		13.0441-3801.2	250058		Dichtungssatz	ATE
	1000 TTS 1200 TT			01.70 07.65	11.71 11.71		03.3215-0221.3	020013		Rz 15,87	
NSU 1000/1200 (63-72)											
	1000			01.68	12.72		03.3115-2651.3	010250		Hz 15,87	ATE
	1000 1200			01.66 09.67	12.72 11.71		13.0441-3801.2	250058		Dichtungssatz	ATE
	1000 1200			01.66 09.67	12.72 11.71		13.0460-3010.2 13.0460-0014.2	603010 610014		20009 15,0 Belagsatz-Zubehör	ATE ATE
	1000			08.63	12.67		03.3217-0401.3	020023		Rz 17,46	
	1000 1200			08.63 09.67	12.72 11.71		03.3215-0221.3 03.3219-0203.3	020013 020037		Rz 15,87 Rz 19,05	
OPEL ADMIRAL (64-78)											
	Admiral A 2.6 / 2.8 Admiral A 4.6 V8 Admiral B	140		04.64 04.65 01.69	03.69 03.69 01.78		13.0460-6027.2	606027		20011 15,0	ATE
	Admiral B Admiral A 4.6 V8 Admiral B	140		01.69 04.65 01.69	01.78 03.69 01.78		24.0122-0109.1 24.0113-0126.1	422109 413126		271 22,0 19,0 V 271 12,7 9,7	
	Admiral B			01.69	01.78		13.0460-4033.2	604033		20034 15,0	ATE
OPEL ASCONA 16 (70-75)											
	1.2 1.2 1.6 1.6 1.6 N 1.6 N 1.6 S 1.6 S 1.6 S 1.9 1.9	2761365 9662825 2761365 9662825 2761365 9662825 2761365 9662825 2761365 9662825 2761365 9662825		09.75 09.75 09.75 09.75 09.75 09.75 09.75 09.75 09.75 09.75 09.75			03.2120-1981.3	010105	+ Behälter ⁴⁾	Thz 20,64	DEL
	1.2 1.6 1.6 N 1.6 S			01.70 01.70 01.70 01.70	09.75 09.75 09.75 09.75		13.0460-4035.2 13.0460-0038.2	604035 610038		20173 15,0 Belagsatz-Zubehör	ATE ATE

1) - Europe/ + Saloon / - Europa/ + Berlina / - Europe/ + Berline / - Europa/ + Berlina
2) + Europe/ + Estate / + Europa/ + Station Wagon / + Europe/ + Break / + Europa/ + Break
3) + FA disc brake / + A disco freno / + frein à disque essieu AV / + ED disco de freno
4) + reservoir / + serbatoio / + réservoir / + recipiente

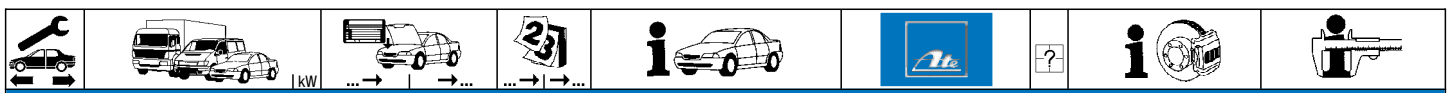

OPEL ASCONA 16 (70-75)												
	1.9				01.70	09.75		13.0460-4035.2	604035		20173 15,0	ATE
								13.0460-0038.2	610038		Belagsatz-Zubehör	ATE
	1.2			52512050	01.70			24.0111-0116.1	411116		238 11,0 8,0	
	1.6			52512050	01.70							
	1.6 N			52512050	01.70							
	1.6 S			52512050	01.70							
	1.9			52512050	01.70							
	1.2	52512051				09.75		24.0113-0125.1	413125		246 12,7 9,7	
	1.6	52512051				09.75						
	1.6 N	52512051				09.75						
	1.6 S	52512051				09.75						
	1.9	52512051				09.75						
	1.6 N			9483907	01.70			03.3215-1701.3	020015		Rz 15,87	
	1.6 N			2453080	01.70							
	1.6 S			9662824	01.70			03.3215-1701.3	020015		Rz 15,87	
	1.6 S			2761436	01.70							
	1.9			9662824	01.70							
	1.9			2761436	01.70							
	1.6 S	2761437				09.75		03.3219-4202.3	020050		Rz 19,05	
	1.6 S	9662825				09.75						
	1.9	2761437				09.75						
	1.9	9662825				09.75						
	1.6 N			2453080	01.70			03.0137-0108.2	650108		230 x 51 HEB	
	1.6 S	2560700				09.75		03.0137-9014.2	669014		Bremsbacken-Zubehör	
	1.9					01.70						
	1.2					01.70		24.0220-0001.2	480013		200/201 x 53,5	
	1.6 N			2453080	01.70			24.0223-0008.2	480038		230/231 x 60	
	1.6 S					01.70						
	1.9					01.70						
	1.6 N	2453081				09.75		24.0220-0001.2	480013		200/201 x 53,5	

OPEL ASCONA B / Vauxhall Cavalier (75-81)												
	1.2				10.74	02.79		03.2120-1981.3	010105	+ Behälter ¹⁾	Thz 20,64	DEL
	1.3				10.74	07.81						
	1.6				10.74	07.81						
	1.9				10.74	12.77						
	2.0				10.74	07.81						
	2.0 D				10.74	07.81						
	1.2				02.79			03.2120-0538.3	010077		Thz 20,64	ATE
	1.2	81000438			02.79							
	1.2	85000001			07.81							
	1.3	81000438			07.81							
	1.3	85000001			07.81							
	1.6	81000438			07.81							
	1.6	85000001			07.81							
	2.0	81000438			07.81							
	2.0	85000001			07.81							
	2.0 D	81000438			07.81							
	2.0 D	85000001			07.81							
	1.2				10.76	12.77		03.3508-7504.3	310045		Behälter	ATE
	1.3				10.76	12.77						
	1.6				10.76	12.77						
	1.9				10.76	12.77						
	1.2				10.74	02.79	+ Festsättel ²⁾	13.0441-4825.2	250107		Dichtungssatz	ATE
	1.3				10.74	07.81	+ Festsättel ²⁾					
	1.6				10.74	07.81	+ Festsättel ²⁾					
	1.9				10.74	12.77	+ Festsättel ²⁾					
	2.0				01.78	07.81						
	2.0 D				09.78	07.81						
	1.3				03.79	07.81	+ Faustsättel ³⁾	24.0101-4801.2	990131		Bremssattel-Zubehör	DEL
	1.6				03.79	07.81	+ Faustsättel ³⁾					
	2.0				03.79	07.81	+ Faustsättel ³⁾					
	2.0 D				03.79	07.81	+ Faustsättel ³⁾					
	1.2				10.74	02.79	+ Festsättel ²⁾	13.0460-5030.2	605030		20323 16,5	ATE
	1.3				10.74	07.81	+ Festsättel ²⁾					
	1.6				10.74	07.81	+ Festsättel ²⁾					
	1.9				10.74	12.77	+ Festsättel ²⁾					
	2.0				01.78	07.81	+ Festsättel ²⁾					
	2.0 D				09.78	07.81	+ Festsättel ²⁾					
	1.3				03.79	07.81	+ Faustsättel ³⁾	13.0460-7048.2	607048		20939 15,8 /WE	DEL
	1.6				03.79	07.81	+ Faustsättel ³⁾	13.0460-0127.2	610127		Belagsatz-Zubehör	DEL
	2.0				03.79	07.81	+ Faustsättel ³⁾					
	2.0 D				03.79	07.81	+ Faustsättel ³⁾					
	1.2				10.74	02.79		24.0113-0125.1	413125		246 12,7 9,7	
	1.3				10.74	07.81						
	1.6				10.74	07.81						
	1.9				10.74	12.77						
	2.0				01.78	07.81						
	2.0 D				09.78	07.81						
	1.3 S				03.79	07.81		03.3219-4202.3	020050		Rz 19,05	
	1.6 N				10.74	07.81	+ Automatikgetriebe ⁴⁾					
	1.6 S				10.74	07.81						
	1.9				10.74	12.77						
	2.0				01.78	07.81						

1) + réservoir / + serbatoio / + réservoir / + recipiente
2) + fixed calipers / + pinze freno fisse / + étriers fixes / + pinza de fija
3) + fist type calipers / + pinza freno flottante / + étriers à griffe / + pinza de puno
4) + autom.transmission / + scatola cambio automatico / + transmission automatique / + cambio automático



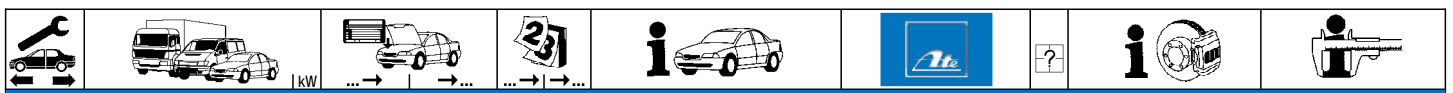

OPEL ASCONA B / Vauxhall Cavalier (75-81)										
	2.0 D				09.78	07.81		03.3219-4202.3	020050	Rz 19,05
	1.3 S				03.79	07.81		03.0137-0108.2	650108	230 x 51 HEB Bremsbacken-Zubehör
	1.6 N				10.74	07.81	+ Automatikgetriebe ¹⁾	03.0137-9014.2	669014	
	1.6 S				10.74	07.81				
	1.9				10.74	12.77				
	2.0				01.78	07.81				
	2.0 D				09.78	07.81				
	1.2				10.74	02.79		24.0220-0001.2	480013	200/201 x 53,5
	1.3 N				10.74	07.81				
	1.6 N				10.74	07.81	+ Schaltgetriebe ²⁾			
	1.3 S				03.79	07.81		24.0223-0008.2	480038	230/231 x 60
	1.6 N				10.74	07.81	+ Automatikgetriebe ¹⁾			
	1.6 S				10.74	07.81				
	1.9				10.74	12.77				
	2.0				01.78	07.81				
	2.0 D				09.78	07.81				

OPEL ASCONA C / Vauxhall Cavalier (82-88)												
	1.3			G1000071	08.81			03.2120-2598.3	010116	Thz 20,64	ATE	
	1.3			F5000000	08.81							
	1.6			G1000071	08.81							
	1.6			F5000000	08.81							
	1.6 D			G1000071	01.82							
	1.6 D			F5000000	01.82							
	1.3		G1000072		08.88			03.2120-2597.3	010115	Thz 20,64	ATE	
	1.6		G1000072		08.88							
	1.6 D		G1000072		08.88							
	1.8		G1000072		08.88		- ABS					
	2.0		G1000072		08.88		- ABS					
	1.3			G6000000	08.81			03.2120-2598.3	010116	Thz 20,64	ATE	
	1.3			F6000000	08.81							
	1.6			G6000000	08.81							
	1.6			F6000000	08.81							
	1.6 D			G6000000	01.82							
	1.6 D			F6000000	01.82							
	1.3		G6000001		08.88			03.2120-2597.3	010115	Thz 20,64	ATE	
	1.6		G6000001		08.88							
	1.6 D		G6000001		08.88							
	1.8		G6000001		08.88		- ABS					
	2.0		G6000001		08.88		- ABS					
	1.3				08.81	08.88		03.2120-2381.3	010111	2 links M10/ 2 unten links M15 ³⁾	Thz 20,64 + Behälter	DEL
	1.6				08.81	08.88						
	1.6 D				01.82	08.88						
	1.8 i				09.82	08.88						
	1.3				08.81	08.88		24.3481-0707.5	240023		D=48, - Halter	DEL
	1.6				08.81	08.88		24.3481-0708.5	240024		D=48, - Halter	DEL
	1.6 D				01.82	08.88		11.0441-4803.2	250018		Dichtungssatz	ATE
	1.8				09.82	08.88		11.0101-4802.2	260007		Hülssensatz	ATE
	1.8 i NE				09.82	08.88	+ Automatikgetriebe ¹⁾	24.0101-4801.2	990131		Bremssattel-Zubehör	DEL
	1.8 i				09.82	08.88		24.0101-4801.2	990131		Bremssattel-Zubehör	DEL
	1.8 i NE				09.82	08.88	+ Schaltgetriebe ²⁾					
	2.0 i N				10.87	08.88						
	2.0 i S				10.87	08.88		24.3521-1701.5	240001		D=52, - Halter	ATE
								24.3521-1702.5	240002		D=52, - Halter	ATE
								11.0441-5202.2	250026		Dichtungssatz	ATE
								11.0101-5407.2	260011		Hülssensatz	ATE
								11.8171-0008.1	990049		Führungsbolzen	ATE
								11.8116-0097.1	390590	2	Haltefeder	ATE
	1.3				08.81	08.88		13.0460-7048.2	607048		20939 15,8 /WE	DEL
	1.6				08.81	08.88		13.0460-0127.2	610127		Belagsatz-Zubehör	DEL
	1.6 D				01.82	08.88						
	1.8				09.82	08.88	- belüftete Scheiben ⁴⁾					
	1.8 i				09.82	08.88	+ belüftete Scheiben ⁵⁾	13.0460-7048.2	607048		20939 15,8 /WE	DEL
	2.0 i N				10.87	08.88		13.0460-0205.2	610205		Belagsatz-Zubehör	DEL
	2.0 i S				10.87	08.88		13.0460-7052.2	607052		21190 17,5 +/WE	ATE
								13.0460-7048.2	607048		20939 15,8 /WE	DEL
								13.0460-0205.2	610205		Belagsatz-Zubehör	DEL
	1.3				08.81	08.88		24.0113-0161.1	413161		236 12,7 9,7 +S +B	
	1.6				08.81	08.88		24.0313-0161.1	513161		236 12,7 9,7 +S +B PD	
	1.6 D				01.82	08.88						
	1.8				09.82	08.88	- belüftete Scheiben ⁴⁾					
	1.8 i				09.82	08.88	+ belüftete Scheiben ⁵⁾	24.0120-0115.1	420115		236 20,0 17,0 V L +S +B	
	2.0 i N				08.81	08.88		24.0320-0115.1	520115		236 20,0 17,0 V L +S +B PD	
	2.0 i S				10.87	08.88		24.0124-0115.1	424115		256 24,0 21,0 V L +S +B	
								24.0324-0115.1	524115		256 24,0 21,0 V L +S +B PD	
	1.3			FV199999	08.81			83.6288-0314.3	330338	2	Bördel E ⁶⁾	L=310
	1.6			FV199999	08.81							
	1.6 D			FV199999	01.82							
	1.8			FV199999	09.82							
	1.8 i			FV199999	08.88							
	2.0			FV199999	08.81							
	1.3		G6000001		08.88			24.5298-0322.3	331314	2	Bördel F ⁷⁾	L=322
	1.6		G6000001		08.88							

¹⁾ + autom.transmission / + scatola cambio automatico / + transmission automatique / + cambio automático
²⁾ + manual transmission / + scatola cambio velocità / + transmission mécanique / + cambio de velocidad
³⁾ 2 left M10/ 2 lower left M15 / 2 sinist.M10/2 sinis.basso M15 / 2 gauch.M10/2 izquie.abajo M15
⁴⁾ - ventilated discs / - dischi ventilati / - disques ventilés / - disco ventilado
⁵⁾ + ventilated discs / + dischi ventilati / + disques ventilés / + disco ventilado
⁶⁾ flare type E / bordatura tipo E / colet E / reborde E
⁷⁾ flare type F / bordatura tipo F / colet F / reborde F

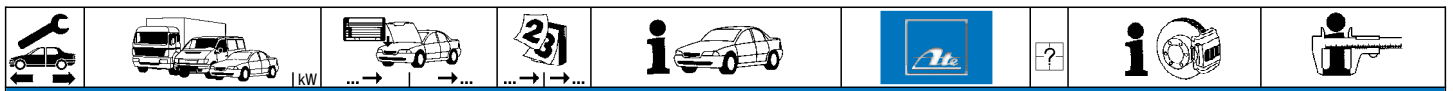

OPEL ASCONA C / Vauxhall Cavalier (82-88)

	1.6 D	G6000001		08.88	24.5298-0322.3	331314	2	Bördel F ¹⁾	L=322	
	1.8	G6000001		08.88						
	1.8 i	G6000001		08.88						
	2.0	G6000001		08.88						
	1.3		G1000071	08.81	83.6267-0195.3	330737	2	Bördel E ²⁾	L=195	
	1.6		G1000071	08.81						
	1.6 D		G1000071	01.82						
	1.8		G1000071	09.82						
	2.0		G1000071	08.81						
	1.3		G1000072		08.88	24.5233-0200.3	330425	2	Bördel F ¹⁾	L=198
	1.6		G1000072		08.88					
	1.6 D		G1000072		08.88					
	1.8		G1000072		08.88					
	2.0		G1000072		08.88					
	1.3		G6000000	08.81	83.6267-0195.3	330737	2	Bördel E ²⁾	L=195	
	1.6		G6000000	08.81						
	1.6 D		G6000000	01.82						
	1.8		G6000000	09.82						
	1.8 i		G6000000	09.82						
	2.0		G6000000	08.81						
	1.3		G6000001		08.88	24.5233-0200.3	330425	2	Bördel F ¹⁾	L=198
	1.6		G6000001		08.88					
	1.6 D		G6000001		08.88					
	1.8		G6000001		08.88					
	1.3		G1001771	08.81	24.3217-1102.3	020168			Rz 17,46 LUC	
	1.6		G1001771	08.81						
	1.6 D		G1001771	01.82						
	1.8		G1001771	01.82						
	2.0 i N		G1001771	08.81						
	1.3		G1001772		08.88	03.3217-3512.3	020032		Rz 17,46 LUC	
	1.6		G1001772		08.88					
	1.6 D		G1001772		08.88					
	1.8		G1001772		08.88					
	2.0 i N		G1001772		08.88					
	1.3		G6000000	08.81	24.3217-1102.3	020168			Rz 17,46 LUC	
	1.6		G6000000	08.81						
	1.6 D		G6000000	01.82						
	1.8		G6000000	01.82						
	2.0 i N		G6000000	08.81						
	1.3		G6000001		08.88	03.3217-3512.3	020032		Rz 17,46 LUC	
	1.6		G6000001		08.88					
	1.6 D		G6000001		08.88					
	1.8		G6000001		08.88					
	2.0 i N		G6000001		08.88					
	2.0 i S			10.87	08.88	24.3219-1767.3	020552	+ GG ³⁾	Rz 19,05	
						24.3219-1715.3	020122	+ ALU ⁴⁾	Rz 19,05 (ALU)	
	1.3		E6005529	08.81	03.0137-9034.2	669034			Bremsbacken-Zubehör	
	1.3		E5008740	08.81						
	1.3		D1288027	08.81						
	1.6		E6005529	08.81						
	1.6		E5008740	08.81						
	1.6		D1288027	08.81						
	1.6 D		E6005529	01.82						
	1.6 D		E5008740	01.82						
1.6 D		D1288027	01.82							
1.8		E6005529	09.82							
1.8		E5008740	09.82							
1.8		D1288027	09.82							
2.0		E6005529	08.81							
2.0		E5008740	08.81							
2.0		D1288027	08.81							
	1.3		D1288028		08.88	03.0137-0166.2	650166		200 x 46 HEB LUC	
	1.3		E5008741		08.88	03.0137-9060.2	669060		Bremsbacken-Zubehör LUC	
	1.3		E6005530		08.88					
	1.6		D1288028		08.88					
	1.6		E5008741		08.88					
	1.6		E6005530		08.88					
	1.6 D		D1288028		08.88					
	1.6 D		E5008741		08.88					
	1.6 D		E6005530		08.88					
	1.8		D1288028		08.88					
1.8		E5008741		08.88						
1.8		E6005530		08.88						
2.0		D1288028		08.88						
2.0		E5008741		08.88						
2.0		E6005530		08.88						
	1.3			08.81	08.88	24.0220-0001.2	480013		200/201 x 53,5	
	1.6			08.81	08.88					
	1.6 D			01.82	08.88					
	1.8			09.82	08.88					
	2.0			08.81	08.88					

1) flare type F / bordatura tipo F / colet F / reborde F
 2) flare type E / bordatura tipo E / colet E / reborde E
 3) + cast iron / + ghisa / + fonte grise / + fundición de gris
 4) + aluminium / + alluminio / + aluminium / + aluminio



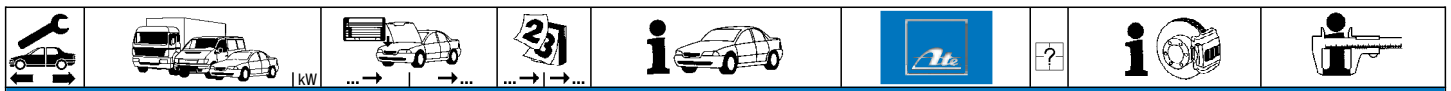

OPEL ASCONA C / Vauxhall Cavalier (82-88)

	1.3		EV111690	08.81		24.3727-0711.2	580711	<input type="checkbox"/>	L=862, + Zub L=2022, + Zub
	1.3		E6005529	08.81		24.3727-0712.2	580712	<input type="checkbox"/>	
	1.3		E5008740	08.81					
	1.3		D1288027	08.81					
	1.6		EV111690	08.81					
	1.6		E6005529	08.81					
	1.6		E5008740	08.81					
	1.6		D1288027	08.81					
	1.6 D		EV111690	01.82					
	1.6 D		E6005529	01.82					
	1.6 D		E5008740	01.82					
	1.6 D		D1288027	01.82					
	2.0		EV111690	08.81					
	2.0		E6005529	08.81					
2.0		E5008740	08.81						
2.0		D1288027	08.81						
	1.3	E6005530	G6000000			24.3727-0723.2	580723	<input type="checkbox"/>	L=850, + Zub
	1.3	D1288028	G1000071						
	1.3	E5008741		08.88					
	1.3	EV111691		08.88					
	1.6	E6005530	G6000000						
	1.6	D1288028	G1000071						
	1.6	E5008741		08.88					
	1.6	EV111691		08.88					
	1.6 D	E6005530	G6000000						
	1.6 D	D1288028	G1000071						
	1.6 D	E5008741		08.88					
	1.6 D	EV111691		08.88					
	1.8		G6000000	09.82					
	1.8		G1000071	09.82					
2.0	E6005530	G6000000							
2.0	D1288028	G1000071							
2.0	E5008741		08.88						
2.0	EV111691		08.88						
	1.3	G1000072		08.88		24.3727-0734.2	580734	<input type="checkbox"/>	L=750, + Zub L=2023, + Zub
	1.3	G6000001		08.88		24.3727-0727.2	580727	<input type="checkbox"/>	
	1.6	G1000072		08.88					
	1.6	G6000001		08.88					
	1.6 D	G1000072		08.88					
	1.6 D	G6000001		08.88					
	1.8	G1000072		08.88					
	1.8	G6000001		08.88					
	2.0	G1000072		08.88					
	2.0	G6000001		08.88					
	1.3			08.81	08.88	24.3728-0708.2	590708		L=795
	1.6			08.81	08.88				
	1.6 D			01.82	08.88				
	1.8			09.82	08.88				
	2.0			08.81	08.88				

OPEL CAMPO (91-96)

	2.2 D			01.92	09.92	03.2120-1981.3	010105		Thz 20,64	DEL
	2.2 D 4x4			09.90	09.92					
	2.3			01.92	09.92					
	2.3 4x4			06.90	09.92					
	2.5 D			01.92	09.92					
	2.5 D 4x4			06.90	09.92					
	3.1 TD			01.92	09.92					
	2.2 D			01.92	08.96	13.0460-5942.2	605942		21544 16,5 +/-WK Belagsatz-Zubehör	AKE AKE
	2.2 D 4x4			09.90	08.96	13.0460-0337.2	610337			
	2.3			01.92	08.96					
	2.3 4x4			06.90	08.96					
	2.5 D			01.92	08.96					
	2.5 D 4x4			06.90	08.96					
	3.1 TD			01.92	08.96					
	2.2 D			01.92	08.96	24.0122-0156.1	422156		257 22,0 20,6 V	
	2.2 D 4x4			09.90	08.96					
	2.3			01.92	08.96					
	2.3 4x4			06.90	08.96					
	2.5 D			01.92	08.96					
	2.5 D 4x4			06.90	08.96					
	3.1 TD			01.92	08.96					
	2.2 D			01.92	08.96	24.3225-1702.3	020425		Rz 25,40	
	2.2 D 4x4			09.90	08.96					
	2.3			01.92	08.96					
	2.3 4x4			06.90	08.96					
	2.5 D			01.92	08.96					
	2.5 D 4x4			06.90	08.96					
	3.1 TD			01.92	08.96					



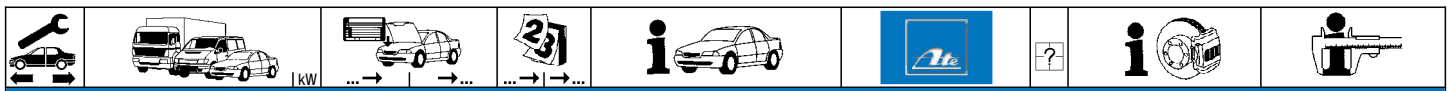

OPEL COMMODORE A / Vauxhall Viceroy (67-71)

	2.5 GS 2.5 GS/E 2.5 S 2.8 GS	96 110 107		08.67 08.69 08.67 05.70	12.71 12.71 12.71 12.71		13.0460-6027.2	606027			20011 15,0	ATE
	2.5 GS 2.5 GS/E 2.5 S 2.8 GS	96 110 107		08.67 08.69 08.67 05.70	12.71 12.71 12.71 12.71		24.0113-0126.1	413126			271 12,7 9,7	

OPEL COMMODORE B / Vauxhall Viceroy (72-78)

	2.5 2.8 GS/E		51000104	01.72 01.72	12.77 + HA-Trommelbremse 1)		03.2123-6207.3	010185			THz 23,81	ATE
	2.8 GS/E		51000105		12.77 + HA-Scheibenbremse 2)		03.2123-4911.3	010182			THz 23,81	ATE
	2.5 2.8 GS/E		51000104	01.72 01.72	12.77 + HA-Trommelbremse 1)		03.3508-7504.3 03.3304-1400.1	310045 390088			Behälter Behälterstopfen	ATE
	2.5 2.8 GS/E			01.72 01.72	12.77 12.77		13.0441-5411.2	250114			Dichtungssatz	ATE
	2.5 2.5 S 2.8 GS/E			01.72 01.72 01.72	07.78 07.78 07.78		13.0460-6027.2	606027			20011 15,0	ATE
	2.5 S 2.8 GS/E			01.72 01.72	12.77 12.77		24.0113-0126.1	413126			271 12,7 9,7	
	2.8 GS/E		51000105		12.77		24.0122-0109.1	422109			271 22,0 19,0 V	
	2.8 GS/E		51000105		12.77		13.0460-4035.2	604035			20173 15,0	ATE
	2.5 2.8 GS/E		51000104	01.72 01.72	12.77 12.77		03.3222-6903.3	020084			Rz 22,20	
	2.5 2.8 GS/E		5161205 51000104	12.77 01.72	12.77		03.0137-0108.2 03.0137-9014.2	650108 669014			230 x 51 HEB Bremsbacken-Zubehör	

OPEL COMMODORE C / Vauxhall Viceroy (78-83)

	2.5 E 2.5 S			04.82 01.78	12.83 12.83	- verstärkte Bremse 3) - verstärkte Bremse 3)	03.2123-6207.3	010185			THz 23,81	ATE
	2.5 S Limousine 2.5 E Limousine		11001886	01.78			13.0441-5411.2	250114			Dichtungssatz	ATE
	2.5 S Limousine 2.5 E Limousine 2.5 S Caravan			04.82 01.81	12.83 12.83		13.0460-4048.2 13.0460-0165.2	604048 610165			20011 15,0 /WE Belagsatz-Zubehör	ATE ATE
	2.5 S Limousine 2.5 E Limousine 2.5 S Caravan			01.78 04.82 01.81	12.83 12.83 12.83		24.0113-0126.1 24.0122-0109.1	413126 422109			271 12,7 9,7 271 22,0 19,0 V	
	2.5 E 2.5 S			01.78 01.78	12.83 12.83		83.6267-0285.3	330332	2		L=285	
	2.5 E 2.5 S			04.82 01.78	12.83 12.83		03.3222-6903.3	020084			Rz 22,20	
	2.5 E Limousine 2.5 S Limousine			04.82 01.78	12.83 12.83		03.0137-0108.2 03.0137-9014.2	650108 669014			230 x 51 HEB Bremsbacken-Zubehör	

OPEL CORSA A / Vauxhall Nova (83-92)











	1.0 S 1.2 1.3 1.4 1.4 N		M4999999 M4999999 M4999999 M4999999 M4999999	09.82 09.82 09.82 08.89 08.89			24.3481-0705.5 24.3481-0706.5 24.0101-4801.2	240021 240022 990131			D=48, - Halter D=48, - Halter Bremsattel-Zubehör	DEL DEL DEL
	1.5 D 1.5 TD 1.6 i N		M4999999 M4999999 M4999999	09.87 03.88 03.88			24.3481-0707.5 24.3481-0708.5 24.0101-4801.2	240023 240024 990131			D=48, - Halter D=48, - Halter Bremsattel-Zubehör	DEL DEL DEL
	1.6 i SE		M4999999	01.88			24.0101-4801.2	990131			Bremsattel-Zubehör	DEL
	1.0 S 1.2 1.4 1.4 N 1.5 D 1.5 TD		N4000001 N4000001 N4000001 N4000001 N4000001 N4000001	10.92 10.92 10.92 10.92 10.92 10.92			24.3481-1733.5 24.3481-1734.5 11.0441-4811.2 11.0101-5407.2 11.8171-0008.1 11.8116-0129.1	240213 240214 250024 260011 990049 390591			D=48, - Halter D=48, - Halter Dichtungssatz Hülzensatz Führungsbolzen Haltefeder	ATE ATE ATE ATE ATE ATE
	1.4 i SE 1.6 i N 1.6 i SE		N4000001 N4000001 N4000001	10.92 10.92 10.92			11.9481-9871.2 11.9481-9872.2 11.0441-4811.2 11.0101-5407.2 11.8171-0008.1 11.8116-0129.1	220681 220682 250024 260011 990049 390591			D=48, - Halter D=48, - Halter Dichtungssatz Hülzensatz Führungsbolzen Haltefeder	ATE ATE ATE ATE ATE ATE
	1.0 S 1.2 1.3		M4999999 M4999999 M4999999	09.82 09.82 09.82			13.0460-7048.2 13.0460-0127.2	607048 610127			20939 15,8 /WE Belagsatz-Zubehör	DEL DEL

1) + RA drum brake / + P freno a tamburo / + frein à tambour essieu AR / + ET-tambores de freno
 2) + RA disc brake / + P disco freno / + frein à disque essieu AR / + ET-disco de freno
 3) - heavy duty brake / - freno rinforzato / - frein renforcé / - freno reforzado



OPEL CORSA A / Vauxhall Nova (83-92)											
	1.4			M4999999	08.89		13.0460-7048.2	607048		20939 15,8 /WE	DEL
	1.4 N			M4999999	08.89		13.0460-0127.2	610127		Belagsatz-Zubehör	DEL
	1.5 D			M4999999	09.87						
	1.5 TD			M4999999	03.88						
	1.6 i N			M4999999	03.88						
	1.6 i SE			M4999999	01.88		13.0460-7048.2	607048		20939 15,8 /WE	DEL
							13.0460-0205.2	610205		Belagsatz-Zubehör	DEL
	1.0 S		N4000001			10.92	13.0460-7051.2	607051		20547 16,5 +/-WE	ATE
	1.2		N4000001			10.92					
	1.4		N4000001			10.92					
1.4 i SE		N4000001			10.92						
1.4 N		N4000001			10.92						
1.5 D		N4000001			10.92						
1.5 TD		N4000001			10.92						
1.6 i N		N4000001			10.92						
1.6 i SE		N4000001			10.92						
	1.0 S			M4999999	09.82		24.0110-0152.1	410152		236 10,0 7,0 +S	
	1.2			M4999999	09.82						
	1.3			M4999999	09.82						
	1.4			M4999999	08.89						
	1.4 N			M4999999	08.89						
	1.0 S		N4000001			10.92	24.0113-0161.1	413161		236 12,7 9,7 +S +B	
	1.2		N4000001			10.92	24.0313-0161.1	513161		236 12,7 9,7 +S +B PD	
	1.4		N4000001			10.92					
	1.4 N		N4000001			10.92					
	1.5 D				09.87	10.92					
1.5 TD				03.88	10.92						
1.6 i N			M4999999	03.88	10.92						
1.4 i SE		N4000001			10.92	24.0120-0115.1	420115		236 20,0 17,0 V L +S +B		
1.6 i N		N4000001			10.92	24.0320-0115.1	520115		236 20,0 17,0 V L +S +B PD		
1.6 i SE				01.88	10.92						
	1.0			F4999999	09.82		24.5232-0283.3	331323	2	L=283	
	1.2			F4999999	09.82						
	1.3			F4999999	09.82						
	1.4 i SE			F4999999	09.91						
	1.4 N			F4999999	08.89						
	1.6 i SE			F4999999	01.88						
	1.0		G4000001			10.92	24.5232-0283.3	331323	2	L=283	
	1.2		G4000001			10.92					
	1.3		G4000001			10.92					
	1.4			08.89	10.92						
1.4 i SE		G4000001			10.92						
1.4 N		G4000001			10.92						
1.5 D			09.87	10.92							
1.5 TD			03.88	10.92							
1.6			03.88	10.92							
1.6 i SE		G4000001			10.92						
	1.0			F4999999	09.82		83.6267-0195.3	330737	2	L=195	
	1.2			F4999999	09.82						
	1.3			F4999999	09.82						
	1.4 i SE			F4999999	09.91						
	1.4 N			F4999999	08.89						
	1.6 i SE			F4999999	01.88						
	1.0		G4000001			10.92	24.5233-0200.3	330425	2	L=198	
	1.2		G4000001			10.92					
	1.3		G4000001			10.92					
	1.4			08.89	10.92						
1.4 i SE		G4000001			10.92						
1.4 N		G4000001			10.92						
1.5 D			09.87	10.92							
1.5 TD			03.88	10.92							
1.6			03.88	10.92							
1.6 i SE		G4000001			10.92						
	1.0 S			F4999999	09.82		24.3214-1101.3	020148		Rz 14,29	LUC
	1.0 S		G4000001	M4999999			24.3214-1102.3	020149		Rz 14,29	LUC
	1.0 S			F4999999	09.82		24.3217-1102.3	020168		Rz 17,46	LUC
	1.2			F4999999	09.82						
	1.3			F4999999	09.82						
	1.0 S		G4000001			10.92	03.3217-3512.3	020032		Rz 17,46	LUC
	1.0 S		M4000001			10.92					
	1.2		G4000001			10.92					
	1.3		G4000001			10.92					
	1.4 N			N4000000	08.89	10.92					
1.5 D				09.87	10.92						
1.5 TD				03.88	10.92						
1.6 i N				03.88	10.92						
1.6 i SE				01.88	10.92						
	1.0			E4008340	09.82		03.0137-0143.2	650143		200 x 29 HEB	
	1.2			E4008340	09.82						
	1.3			E4008340	09.82						
	1.0		E4008341	M4999999			03.0137-0165.2	650165		200 x 29 HEB	LUC
	1.2		E4008341	M4999999			03.0137-9054.2	669054		200 x 29 HEB	LUC
	1.3		E4008341	M4999999							
	1.4			M4999999	08.89						
	1.5 D			M4999999	09.87						

1) - heavy duty brake / - freno rinforzato / - frein renforcé / - freno reforzado
2) + heavy duty brake / + freno rinforzato / + frein renforcé / + freno reforzado
3) - EC regulation / - normativa CEE / - prescription CEE / - según normativa CEE

OPEL CORSA A / Vauxhall Nova (83-92)											
	1.5 TD 1.6		M4999999 M4999999	03.88 03.88		03.0137-0165.2 03.0137-9054.2	650165 669054			200 x 29 HEB Bremsbacken-Zubehör	LUC LUC
	1.0 1.2 1.3 1.4 1.5 D 1.5 TD 1.6	N4000001 N4000001 N4000001 N4000001 N4000001 N4000001 N4000001		10.92 10.92 10.92 10.92 10.92 10.92 10.92		03.0137-0266.2 03.0137-9166.2	650266 669166			200 x 29 HEB Bremsbacken-Zubehör	
	1.0 1.2 1.3 1.4 1.5 D 1.5 TD 1.6			09.82 09.82 09.82 08.89 09.87 03.88 03.88	10.92 10.92 10.92 10.92 10.92 10.92 10.92	24.0220-0012.1 24.0220-0712.2	480017 480208			200/201 x 35 - Lager 200/201 x 35 + Lager	
	1.0 S 1.0 S 1.2 1.3 1.4 N 1.5 D 1.5 TD 1.6 i N 1.6 i SE	G4000001 M4000001 G4000001 G4000001 N4000000 N4000000 N4000000 N4000000 N4000000	N4000000 N4000000 N4000000 N4000000 N4000000 N4000000 N4000000 N4000000 N4000000	08.89 09.87 03.88 03.88 03.88		+ verstärkte Bremse ¹⁾ - EG Vorschrift ²⁾	03.0520-0817.3	690817		17,46/200x29 TopKit	LUC LUC
	1.0 1.2 1.3 1.4 1.5 D 1.5 TD 1.6	N4000001 N4000001 N4000001 N4000001 N4000001 N4000001 N4000001		10.92 10.92 10.92 10.92 10.92 10.92 10.92		03.0520-1917.3	691917			17,46/200x29 TopKit	LUC
	1.0 1.2 1.3		F4999999 F4999999 F4999999	09.82 09.82 09.82		24.3727-0721.2 24.3727-0722.2	580721 580722	<input type="checkbox"/> <input checked="" type="checkbox"/>		L=816, + Zub L=1429, + Zub	
	1.0 1.2 1.3 1.4 1.4 i SE 1.4 N 1.5 D 1.5 TD 1.6 1.6 i SE	G4000001 G4000001 G4000001	N4052760 N4052760 N4052760 N4052760 N4052760 N4052760 N4052760 N4052760 N4052760	08.89 09.91 08.89 09.87 03.88 03.88 01.88		24.3727-0728.2 24.3727-0729.2	580728 580729	<input type="checkbox"/> <input checked="" type="checkbox"/>		L=960, + Zub L=1400, + Zub	
	1.0 1.2 1.3 1.4 1.4 i SE 1.4 N 1.5 D 1.5 TD 1.6 1.6 i SE	N4052761 N4052761 N4052761 N4052761 N4052761 N4052761 N4052761 N4052761 N4052761		10.92 10.92 10.92 10.92 10.92 10.92 10.92 10.92 10.92		24.3727-0737.2 24.3727-0738.2	580737 580738	<input type="checkbox"/> <input checked="" type="checkbox"/>		L=1241, + Zub L=1035, + Zub	
	1.0 S 1.2 1.3 1.4 i SE 1.4 N 1.5 D 1.5 TD 1.6 i N 1.6 i SE			09.82 09.82 09.82 09.91 08.89 09.87 03.88 03.88 01.88	10.92 10.92 10.92 10.92 10.92 10.92 10.92 10.92 10.92	24.3728-0710.2	590710			L=693	
OPEL DIPLOMAT A (64-69)											
	4.6 V8 5.4	140 169		10.64 03.65	03.69 03.69	13.0460-6027.2	606027			20011 15,0	ATE
	4.6 V8 5.4	140 169		10.64 03.65	03.69 03.69	24.0113-0126.1	413126			271 12,7 9,7	
OPEL DIPLOMAT B (69-78)											
	2.8 2.8 E 5.4	103 121 169		09.72 03.69 03.69		13.0460-6027.2	606027			20011 15,0	ATE
	2.8 2.8 E 5.4	103 121 169		09.72 03.69 03.69		24.0122-0109.1	422109			271 22,0 19,0 V	
	2.8 2.8 E 5.4	103 121 169		09.72 03.69 03.69		13.0460-4033.2	604033			20034 15,0	ATE

¹⁾ + heavy duty brake / + freno rinforzato / + frein renforcé / + freno reforzado
²⁾ - EC regulation / - normativa CEE / - prescription CEE / - según normativa CEE



OPEL GT (68-73)										
	1.9	66		09.68	08.73		03.3215-1701.3	020015		Rz 15,87
OPEL KADETT B (65-73)										
	1.1 1.2 1.7 1.9			01.66 01.66 01.66 01.66	12.73 12.73 12.73 12.73	+ Bremsgerät ¹⁾ + Bremsgerät ¹⁾ + Bremsgerät ¹⁾ + Bremsgerät ¹⁾	03.3508-8302.3	310046		Behälter ATE
	1.1 1.2			01.67 01.67	12.73 12.73		13.0460-3010.2	603010		20009 15,0 ATE
	1.7 1.9 1.9 S Rallye			01.67 01.67 01.71	12.71 12.71 12.73		13.0460-4035.2	604035		20173 15,0 ATE
	1.1 1.2 1.7 1.9 1.9 S Rallye			01.67 01.67 01.67 01.67 01.71	12.73 12.73 12.73 12.73 12.73		24.0111-0116.1	411116		238 11,0 8,0
	1.1 1.2			01.65 01.65	12.73 12.73	+ VA-Trommelbremse ²⁾ + VA-Trommelbremse ²⁾	24.3223-1103.3 24.3223-1104.3	020290 020291	 	Rz 23,81 Rz 23,81
	1.1 1.2 1.7 1.9 1.9 S Rallye			01.66 01.66 01.67 01.67 01.71	12.73 12.73 12.71 12.71 12.73	- Skandinavien ³⁾ - Skandinavien ³⁾	24.3215-1101.3 03.3215-1701.3	020155 020015		Rz 15,87 Rz 15,87
	1.9 S Rallye	2624371		12.73	12.73	+ Skandinavien ⁴⁾	03.3219-4202.3	020050		Rz 19,05
	1.1 1.2			01.65 01.65	12.73 12.73		03.0137-9015.2	669015		Bremsbacken-Zubehör
	1.9 1.9 S Rallye	2560670		12.73 01.71	12.73 12.73		03.0137-0108.2 03.0137-9014.2	650108 669014		230 x 51 HEB Bremsbacken-Zubehör
	1.1 1.1 1.2	2624371		01.65 01.65 01.65	12.73 12.73 12.73	- + Skandinavien ⁴⁾ -	24.0220-0001.2	480013		200/201 x 53,5
	1.7 1.9			01.65 01.65	12.73 12.73		24.0223-0008.2	480038		230/231 x 60
OPEL KADETT C / Vauxhall Chevette (73-79)										
	1.0 1.2 1.6 1.9 2.0			08.77 08.77 08.77 08.77 08.77	07.79 07.79 07.79 07.79 07.79	+ VA-Scheibenbremse/+Bremsgerät ⁵⁾ + VA-Scheibenbremse/+Bremsgerät ⁵⁾ + VA-Scheibenbremse/+Bremsgerät ⁵⁾ + VA-Scheibenbremse/+Bremsgerät ⁵⁾ + VA-Scheibenbremse/+Bremsgerät ⁵⁾	03.2120-0538.3 03.2120-1981.3	010077 010105	+ Behälter ⁶⁾	THz 20,64 THz 20,64 ATE DEL
	1.0 1.2			01.73 01.73	12.75 12.75	+ Bremsgerät ¹⁾ + Bremsgerät ¹⁾	03.3508-8302.3	310046		Behälter ATE
	1.0 1.2			01.73 01.73	07.79 07.79		13.0441-4825.2	250107		Dichtungssatz ATE
	1.6 1.9 2.0			01.75 01.75 01.75	07.79 07.79 07.79		13.0441-4825.2	250107		Dichtungssatz ATE
	1.0 1.2			01.75 01.75	07.79 07.79		13.0460-4035.2 13.0460-0038.2	604035 610038		20173 15,0 ATE Belagsatz-Zubehör ATE
	1.6 1.9 2.0			01.75 01.75 01.75	07.79 07.79 07.79		13.0460-5030.2	605030		20323 16,5 ATE
	1.0 1.2			01.73 01.73	07.79 07.79		24.0111-0116.1	411116		238 11,0 8,0
	1.6 1.9 2.0			01.75 01.75 01.75	07.79 07.79 07.79		24.0113-0125.1	413125		246 12,7 9,7
	1.0 1.2			01.77 01.77	07.79 07.79		83.6267-0330.3	330333	2	L=330
	1.6 1.9 2.0			01.78 01.78 01.78	07.79 07.79 07.79		83.6267-0330.3	330333	2	L=330
	1.0 1.2			01.73 01.73	07.79 07.79		24.3223-1103.3 24.3223-1104.3	020290 020291	 	Rz 23,81 Rz 23,81
	1.0 1.2			01.73 01.73	07.79 07.79	- -	24.3215-1101.3	020155		Rz 15,87
	1.6 1.9 2.0			01.75 01.75 01.75	07.79 07.79 07.79		03.3219-4202.3	020050		Rz 19,05
	1.0 1.2			01.73 01.73	07.79 07.79	- EG Vorschrift/ - ⁷⁾ - EG Vorschrift/ - ⁷⁾	03.0137-9015.2	669015		Bremsbacken-Zubehör
	1.6 1.9 2.0			01.75 01.75 01.75	07.79 07.79 07.79		03.0137-0108.2 03.0137-9014.2	650108 669014		230 x 51 HEB Bremsbacken-Zubehör

1) + booster unit / + servofreno / + servo-frein / + servofreno

2) + FA drum brake / + A freno a tamburo / + frein à tambour ess.AV / + ED tambores de freno



























3) - Scandinavia / - Scandinavia / - Scandinavia / - Escandinavia

4) + Scandinavia / + Scandinavia / + Scandinavia / + Escandinavia

5) + FA disc brake/ + booster unit / + A disco freno/ + servofreno / + fr.à disque ess.AV/ + servofr. / + ED-disco de freno/ + servofreno

6) + reservoir / + serbatoio / + réservoir / + recipiente

7) - EG regulation/ - / - normativa CEE/ - / - prescription CEE/ - / - según normativa CEE/ -

        											
OPEL KADETT C / Vauxhall Chevette (73-79)											
	1.0			01.73	07.79	24.0220-0001.2	480013			200/201 x 53,5	
	1.2			01.73	07.79						
	1.6			01.75	07.79	24.0223-0008.2	480038			230/231 x 60	
	1.9			01.75	07.79						
	2.0			01.75	07.79						
OPEL KADETT D / Vauxhall Astra D (79-84)											
	1.0			08.79	07.84	+ Bremsgerät/ + Schaltgetriebe ¹⁾	03.2120-2598.3	010116		THz 20,64	ATE
	1.2 Limousine			08.79	07.84	+ Bremsgerät/ + Schaltgetriebe ¹⁾					
	1.3 Limousine			08.79	07.84	+ Bremsgerät/ + Schaltgetriebe ¹⁾					
	1.6 D Limousine			01.82	07.84	+ Bremsgerät/ + Schaltgetriebe ¹⁾					
	1.6 Limousine			01.82	07.84	+ Bremsgerät/ + Schaltgetriebe ¹⁾					
1.8 i Limousine			01.82	07.84	+ Bremsgerät/ + Schaltgetriebe ¹⁾						
	1.0			05.81	07.84	+ Bremsgerät ²⁾	03.2120-2421.3	010112		THz 20,64 + Behälter	DEL
	1.2			05.81	07.84	+ Bremsgerät ²⁾					
	1.3			05.81	07.84	+ Bremsgerät ²⁾					
	1.6			01.82	07.84						
	1.0			08.79	07.84	+ Bremsgerät ²⁾	03.2120-2381.3	010111		THz 20,64 + Behälter	DEL
	1.2 Limousine			08.79	07.84	+ Bremsgerät ²⁾					
	1.3 Limousine			08.79	07.84	+ Bremsgerät ²⁾					
	1.6 D Limousine			01.82	07.84						
	1.6 Limousine			08.79	07.84						
	1.8 i			08.82	07.84						
	1.0			08.79	09.81		24.0101-4801.2	990131		Bremssattel-Zubehör	DEL
	1.2			08.79	09.81						
	1.3			08.79	09.81	- verstärkte Br./+ Schaltgetr. ³⁾					
	1.0			10.81	07.84		24.3481-0705.5	240021		D=48, - Halter	DEL
	1.2			10.81	07.84		24.3481-0706.5	240022		D=48, - Halter	DEL
	1.3			10.81	07.84	- verstärkte Br./+ Schaltgetr. ³⁾	11.0441-4803.2	250018		Dichtungssatz	ATE
	1.0			10.81	07.84		11.0101-4802.2	260007		Hülzensatz	ATE
	1.2			10.81	07.84		24.0101-4801.2	990131		Bremssattel-Zubehör	DEL
	1.3			08.79	07.84	+ verstärkte Bremse/+ Schaltgetr. ⁴⁾	24.3481-0707.5	240023		D=48, - Halter	DEL
	1.3			08.79	07.84	+ Automatikgetriebe ⁵⁾	24.3481-0708.5	240024		D=48, - Halter	DEL
	1.6			01.82	07.84		11.0441-4803.2	250018		Dichtungssatz	ATE
	1.6 D			01.82	07.84		11.0101-4802.2	260007		Hülzensatz	ATE
	1.6 D			01.82	07.84		24.0101-4801.2	990131		Bremssattel-Zubehör	DEL
	1.8 i			01.82	07.84		24.0101-4801.2	990131		Bremssattel-Zubehör	DEL
		1.0			08.79	07.84		13.0460-7048.2	607048		20939 15,8 /WE
1.2				08.79	07.84		13.0460-0127.2	610127		Belagsatz-Zubehör	DEL
1.3				08.79	07.84		13.0460-0205.2	610205		Belagsatz-Zubehör	DEL
1.6				01.82	07.84						
1.6 D				01.82	07.84						
	1.0			08.79	07.84		24.0110-0152.1	410152		236 10,0 7,0 +S	
	1.2			08.79	07.84						
	1.3			08.79	07.84	- verstärkte Br./+ Schaltgetr. ³⁾					
	1.3			08.79	07.84	+ verstärkte Bremse/+ Schaltgetr. ⁴⁾	24.0113-0161.1	413161		236 12,7 9,7 +S +B	
	1.3			08.79	07.84	+ Automatikgetriebe ⁵⁾	24.0313-0161.1	513161		236 12,7 9,7 +S +B PD	
	1.6			01.82	07.84						
	1.6 D			01.82	07.84						
	1.6 D			01.82	07.84						
	1.8 i			01.82	07.84		24.0120-0115.1	420115		236 20,0 17,0 V L +S +B	
	1.8 i			01.82	07.84		24.0320-0115.1	520115		236 20,0 17,0 V L +S +B PD	
	1.0		D2500064		07.84		83.6288-0314.3	330338	2	L=310	
	1.0		D5000001		07.84						
	1.2		D2500064		07.84						
	1.2		D5000001		07.84						
	1.3		D2500064		07.84						
	1.3		D5000001		07.84						
	1.6 D Limousine			01.82	07.84						
	1.6 Limousine			01.82	07.84						
	1.8 i			01.82	07.84						
	1.0			08.79	07.84		83.6267-0195.3	330737	2	L=195	
	1.2			08.79	07.84						
	1.3			08.79	07.84						
	1.6			01.82	07.84						
	1.6 D			01.82	07.84						
	1.8			01.82	07.84						
	1.8			01.82	07.84						
	1.0			08.79	07.84		24.3214-1101.3	020148		Rz 14,29	LUC
	1.2 Limousine			08.79	07.84						
	1.3 N Limousine			08.79	07.84	- verstärkte Br./+ Schaltgetr. ³⁾					
	1.3 N Limousine			08.79	07.84	+ verstärkte Bremse/+ Schaltgetr. ⁴⁾	24.3217-1102.3	020168		Rz 17,46	LUC
	1.3 N Limousine			08.79	07.84	+ Automatikgetriebe ⁵⁾					
	1.3 S Limousine			08.79	07.84						
	1.6 D Limousine			01.82	07.84						
	1.6 Limousine			01.82	07.84						
	1.8 i			01.82	07.84						
	1.2 Caravan		C2518195		07.84	- verstärkte Bremse ⁶⁾	03.3219-6301.3	020056		Rz 19,05	
1.3 Caravan		C2518195		07.84	+ Schaltgetriebe ⁹⁾						
1.2 Caravan				08.79	+ verstärkte Bremse ¹⁰⁾	03.3219-4202.3	020050		Rz 19,05		
1.3 Caravan				08.79	+ Automatikgetriebe ⁵⁾						
1.6 Caravan		E2501708		07.84		03.3217-3503.3	020031		Rz 17,46		
1.6 Caravan		E5008741		07.84							
1.6 Caravan		E6005530		07.84							
1.6 D Caravan		E2501708		07.84							
1.6 D Caravan		E5008741		07.84							

1) + booster unit/ + manual transm. / + servofreno/+ scatola camb.velocità / + servo-frein/ + transm.mécanique / + servofreno/ + camb.de velocidad
2) + booster unit / + servofreno / + servo-frein / + servofreno
3) - heavy duty br./+ manual trans. / - fr.rinforzato/+ scatola camb.velocità / - frein renforcé/ + transm.mécanique / - freno reforzado/ + camb.velocidad
4) + heavy duty br./+ manual transm. / + fr.rinforzato/+ scatola camb.velocità / + frein renforcé/ + transm.mécanique / + freno reforzado/ + camb.de velocidad
5) + autom.transmission / + scatola cambio automatico / + transmission automatique / + cambio automático

6) - ventilated discs / - dischi ventilati / - disques ventilés / - disco ventilado
7) + ventilated discs / + dischi ventilati / + disques ventilés / + disco ventilado
8) - heavy duty brake / - freno rinforzato / - frein renforcé / - freno reforzado
9) + manual transmission / + scatola cambio velocità / + transmission mécanique / + cambio de velocidad
10) + heavy duty brake / + freno rinforzato / + frein renforcé / + freno reforzado



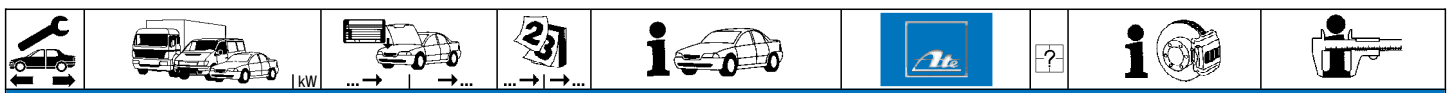

OPEL KADETT D / Vauxhall Astra D (79-84)

	1.6 D Caravan	E6005530		07.84		03.3217-3503.3	020031		Rz 17,46	
	1.0			08.79	07.83	03.0137-0143.2	650143		200 x 29 HEB	
	1.0			08.79	07.81					
	1.2 Limousine			08.79	07.83					
	1.2 Limousine			08.79	07.81					
	1.3 N Limousine			08.79	07.83					
	1.3 N Limousine			08.79	07.81					
	1.0			08.83	07.84	03.0137-0165.2	650165		200 x 29 HEB	LUC
	1.2 Limousine			08.83	07.84	03.0137-9054.2	669054		Bremsbacken-Zubehör	LUC
	1.3 N Limousine			08.83	07.84					
	1.2 Caravan			08.79	07.83	03.0137-9034.2	669034		Bremsbacken-Zubehör	
	1.3 Caravan			08.79	07.83					
	1.3 N Limousine			08.79	07.83					
	1.3 N Limousine			08.81	07.83					
	1.3 N Limousine			08.79	07.83					
	1.3 S Limousine			08.79	07.83					
	1.6 D Limousine			01.82	07.83					
	1.6 Limousine			01.82	07.83					
	1.8 i			01.82	07.83					
	1.0			08.83	07.84	03.0137-0166.2	650166		200 x 46 HEB	LUC
	1.2 Caravan			08.83	07.84	03.0137-9060.2	669060		Bremsbacken-Zubehör	LUC
	1.2 Limousine			08.83	07.84					
	1.3 Caravan			08.83	07.84					
	1.3 N Limousine			08.83	07.84					
	1.3 N Limousine			08.83	07.84					
	1.3 N Limousine			08.83	07.84					
	1.3 S Limousine			08.83	07.84					
	1.6 D Limousine			08.83	07.84					
	1.6 Limousine			08.83	07.84					
	1.8 i			08.83	07.84					
	1.3 Caravan			08.79	07.83	03.0137-0108.2	650108		230 x 51 HEB	
	1.6 Caravan			01.82	07.83	03.0137-9014.2	669014		Bremsbacken-Zubehör	
	1.6 D Caravan			01.82	07.83					
	1.3 Caravan			08.83	07.84	03.0137-0167.2	650167		230 x 51 HEB	LUC
	1.6 Caravan			08.83	07.84	03.0137-9053.2	669053		Bremsbacken-Zubehör	LUC
	1.6 D Caravan			08.83	07.84					
	1.0			08.79	07.84	24.0220-0011.2	480016		200/201 x 38	
	1.0			08.79	07.81					
	1.2 Limousine			08.79	07.84					
	1.2 Limousine			08.79	07.81					
	1.3 N Limousine			08.79	07.84					
	1.3 N Limousine			08.79	07.81					
	1.0			08.81	07.84	24.0220-0001.2	480013		200/201 x 53,5	
	1.2 Caravan			08.79	07.84					
	1.2 Limousine			08.81	07.84					
	1.3 Caravan			08.79	07.84					
	1.3 N Limousine			08.79	07.84					
	1.3 N Limousine			08.79	07.84					
	1.3 N Limousine			08.79	07.81					
	1.3 N Limousine			08.81	07.84					
	1.3 S Limousine			08.79	07.84					
	1.6 D Limousine			01.82	07.84					
	1.6 Limousine			01.82	07.84					
	1.8 i			01.82	07.84					
	1.3 Caravan			08.79	07.84	24.0223-0008.2	480038		230/231 x 60	
	1.6 Caravan			01.82	07.84					
	1.6 D Caravan			01.82	07.84					
	1.0			08.79	07.84	24.3728-0708.2	590708		L=795	
	1.2			08.79	07.84					
	1.3			08.79	07.84					
	1.6			01.82	07.84					
	1.6 D			01.82	07.84					
	1.8			01.82	07.84					













OPEL KADETT E / Vau. Astra E/Belmont (84-93)

	diverse Typen Lim.	J2791977		09.91		24.2120-0913.3	010392	Kennzeichen: EA ⁵⁾	THz 20,64	DEL
	diverse Typen Lim.	J5273428		09.91						
	diverse Typen Lim.	JE222258		09.91						
	diverse Typen Lim.	J2791968		09.91		24.2120-0702.3	010361	Kennzeichen: EB/nicht für Delco BKV ⁶⁾	THz 20,64	
	1.2			08.84	09.91	03.2120-2598.3	010116	mit Adapter für Bördel E ⁷⁾	THz 20,64	ATE
	1.3			08.84	07.90	03.2120-2597.3	010115	Bördel F ⁸⁾	THz 20,64	ATE
	1.4			08.89	09.91					
	1.6			08.84	09.91					
	1.6 D			08.84	12.88					
	1.7 D			01.89	09.91					
	1.6			08.84	09.91	03.2122-0264.3	010129	Kompakt-THz ⁹⁾	THz 22,20	ATE
	1.6 D			08.84	12.88					
	1.7 D			01.89	09.91					
	1.8	L4000000		08.84		03.2120-2598.3	010116	mit Adapter für Bördel E ⁷⁾	THz 20,64	ATE
	1.8	J5273427		08.84		03.2120-2597.3	010115	Bördel F ⁸⁾	THz 20,64	ATE
	1.8	J2791967		08.84						
	2.0 i	L4000000		08.84						
	2.0 i	J5273427		08.84						

1) - heavy duty br./+ manual transm. / - fr.rinforzato/+ scatola camb.velocità / - frein renforcé/ + transm.mécanique / - freno reforzado/ + camb.velocidad
 2) + manual transmission / + scatola cambio velocità / + transmission mécanique / + cambio de velocidad
 3) + heavy duty br./+ manual transm. / + fr.rinforzato/+ scatola camb.velocità / + frein renforcé/ + transm.mécanique / + freno reforzado/ + camb.de velocidad
 4) + autom.transmission / + scatola cambio automatico / + transmission automatique / + cambio automático
 5) registration number: EA / targa: EA / indice: EA / distiutivo: EA

6) registration no.: EB/not for Delco BKV / targa: EB/non per Delco BKV / indice: EB/sans pour Delco BKV / distiutivo: EB/ no para Delco BKV
 7) with adapter for bead type E / con adattatore per bordatura E / avec adaptateur pour coilet E / con adaptador para rebordes E
 8) flare type F / bordatura tipo F / coilet F / reborde F
 9) compact TMC / PFT compatta / MCT compact / CMT compacto



OPEL KADETT E / Vau. Astra E/Belmont (84-93)										
	2.0 i		J2791967	08.84	- ABS	03.2120-2598.3	010116	mit Adapter für Bördel E ¹⁾	THz 20,64	ATE
	1.8 i	J2791968		09.91	- ABS	03.2122-0264.3	010129	Kompakt-THz ³⁾	THz 22,20	ATE
	1.8 i	J5273428		09.91	- ABS					
	1.8 i	L4000001		09.91	- ABS					
	2.0 i	J2791968		09.91	- ABS					
	2.0 i	J5273428		09.91	- ABS					
	2.0 i	L4000001		09.91	- ABS					
	1.2			08.84	09.91 + ABS	03.2122-0282.3	010130		THz 22,20	ATE
	1.3			08.84	09.91 + ABS					
	1.4			08.89	09.91 + ABS					
	1.5 TD			07.88	09.91 + ABS					
	1.6			08.84	09.91 + ABS					
	1.6 D			08.84	09.91 + ABS					
	1.7 D			08.88	09.91 + ABS					
	1.8			08.84	09.91 + ABS					
	2.0			08.85	09.91 + ABS					
	1.2			08.84	09.91 + 10,0 mm Bremsscheiben ⁴⁾	24.3481-0705.5	240021		D=48, - Halter	DEL
	1.3			08.84	09.91 + 10,0 mm Bremsscheiben ⁴⁾	24.3481-0706.5	240022		D=48, - Halter	DEL
	1.4			08.89	09.91 + 10,0 mm Bremsscheiben ⁴⁾	11.0441-4803.2	250018		Dichtungssatz	ATE
	1.4 Limousine			08.89	09.91 + 10,0 mm Bremsscheiben ⁴⁾	11.0101-4802.2	260007		Hülzensatz	ATE
				08.89	09.91 + 10,0 mm Bremsscheiben ⁴⁾	24.0101-4801.2	990131		Bremssattel-Zubehör	DEL
	1.2			08.84	09.91 + 12,7 mm Bremsscheiben ⁵⁾	24.3481-0707.5	240023		D=48, - Halter	DEL
	1.3			08.84	09.91 + 12,7 mm Bremsscheiben ⁵⁾	24.3481-0708.5	240024		D=48, - Halter	DEL
	1.4			08.89	09.91 + 12,7 mm Bremsscheiben ⁵⁾	11.0441-4803.2	250018		Dichtungssatz	ATE
	1.4 Limousine			08.89	09.91 + 12,7 mm Bremsscheiben ⁵⁾	11.0101-4802.2	260007		Hülzensatz	ATE
	1.5 TD			07.88	09.91 + 12,7 mm Bremsscheiben ⁵⁾	24.0101-4801.2	990131		Bremssattel-Zubehör	DEL
	1.6			08.84	09.91 + 12,7 mm Bremsscheiben ⁵⁾					
	1.6 D			08.84	09.91 + 12,7 mm Bremsscheiben ⁵⁾					
	1.7 D			08.88	09.91 + 12,7 mm Bremsscheiben ⁵⁾					
	1.8			08.84	09.91 + 12,7 mm Bremsscheiben ⁵⁾					
	Combo			08.84	09.91 + 12,7 mm Bremsscheiben ⁵⁾					
	1.6			08.84	09.91 + 20,0 mm Bremsscheiben ⁶⁾	24.0101-4801.2	990131		Bremssattel-Zubehör	DEL
	1.6 D			08.84	09.91 + 20,0 mm Bremsscheiben ⁶⁾					
	1.7 D			08.88	09.91 + 20,0 mm Bremsscheiben ⁶⁾					
	1.8 i			08.84	09.91 + 20,0 mm Bremsscheiben ⁶⁾					
	1.8 i			08.84	09.91 + 24,0 mm Bremsscheiben ⁷⁾	24.3521-1701.5	240001		D=52, - Halter	ATE
	2.0 i			08.85	09.91 + 24,0 mm Bremsscheiben ⁷⁾	24.3521-1702.5	240002		D=52, - Halter	ATE
	2.0 i 16V			08.87	09.91 + 24,0 mm Bremsscheiben ⁷⁾	11.0441-5202.2	250026		Dichtungssatz	ATE
						11.0101-5407.2	260011		Hülzensatz	ATE
						11.8171-0008.1	990049		Führungsbolzen	ATE
						11.8116-0097.1	390590	2	Haltefeder	ATE
	1.2			08.84	09.91	13.0460-7048.2	607048		20939 15,8 /WE	DEL
	1.3			08.84	09.91	13.0460-0127.2	610127		Belagsatz-Zubehör	DEL
	1.4			08.89	09.91					
	1.5 TD			07.88	09.91					
	1.6			08.84	09.91					
	1.6 D			08.84	09.91					
	1.7 D			08.88	09.91					
	1.8	L5000000		08.84	09.91	13.0460-7048.2	607048		20939 15,8 /WE	DEL
	1.8 Caravan	K5025260		08.84	09.91	13.0460-0127.2	610127	2	Belagsatz-Zubehör	DEL
	1.8 Caravan	K2500077		08.84	09.91	24.8190-0701.2	620701	2	Warnkontakt L=950mm	DEL
	1.8 Limousine	L5000000		08.84	09.91					
	1.8 Limousine	L2500000		08.84	09.91					
	Combo	L2500000		09.91	09.91					
	1.8	L5000001		09.91	09.91	13.0460-7052.2	607052		21190 17,5 +/WE	ATE
	1.8 Caravan	K2500078		09.91	09.91	13.0460-7048.2	607048		20939 15,8 /WE	DEL
	1.8 Caravan	K5025261		09.91	09.91	13.0460-0205.2	610205		Belagsatz-Zubehör	DEL
	1.8 Limousine	L2500001		09.91	09.91	24.8190-0708.2	620708	2	Warnkontakt L=950mm	ATE
	1.8 Limousine	L5000001		09.91	09.91	24.8190-0701.2	620701	2	Warnkontakt L=950mm	DEL
	2.0 i			08.85	09.91					
	2.0 i 16V			08.87	09.91					
	1.2			08.84	09.91	24.0110-0152.1	410152		236 10,0 7,0 +S	
	1.3			08.84	09.91					
	1.4			08.89	09.91					
	1.2			08.84	09.91	24.0113-0161.1	413161		236 12,7 9,7 +S +B	
	1.3			08.84	09.91	24.0313-0161.1	513161		236 12,7 9,7 +S +B PD	
	1.4			08.89	09.91					
	1.5 TD			07.88	09.91					
	1.6			08.84	09.91					
	1.6 D			08.84	09.91					
	1.7 D			08.88	09.91					
	1.8			08.84	09.91					
	Combo			08.84	09.91					
	1.6			08.84	09.91	24.0120-0115.1	420115		236 20,0 17,0 V L +S +B	
	1.6 D			08.84	09.91	24.0320-0115.1	520115		236 20,0 17,0 V L +S +B PD	
	1.7 D			08.88	09.91					
	1.8 i			08.84	09.91					
	1.8 i			08.84	09.91	24.0124-0115.1	424115		256 24,0 21,0 V L +S +B	
	2.0 i			08.85	09.91	24.0324-0115.1	524115		256 24,0 21,0 V L +S +B PD	
	2.0 i 16V			08.87	09.91					
	1.2		G2502696	08.84	08.84	83.6294-0315.3	330738		L=315	
	1.3		G2502696	08.84	08.84	83.6288-0314.3	330338		L=310	
	1.6		G2502696	08.84	08.84					
	1.6 D		G2502696	08.84	08.84					
	1.8		G2502696	08.84	08.84					

¹⁾ with adapter for bead type E / con adattatore per bordatura E / avec adaptateur pour colet E / con adaptador para rebordes E

²⁾ flare type F / bordatura tipo F / colet F / reborde F

³⁾ compact TMC / PFT compatta / MCT compact / CMT compacto

⁴⁾ + 10,0 mm brake discs / + 10,0 mm dischi freno / + 10,0 mm disques de frein / + 10,0 mm discos de freno

⁵⁾ + 12,7 mm brake discs / + 12,7 mm dischi freno / + 12,7 mm disques de frein / + 12,7 mm discos de freno

⁶⁾ + 20,0 mm brake discs / + 20,0 mm dischi freno / + 20,0 mm disques de frein / + 20,0 mm discos de freno

⁷⁾ + 24,0 mm brake discs / + 24,0 mm dischi freno / + 24,0 mm disques de frein / + 24,0 mm discos de freno



OPEL KADETT E / Vau. Astra E/Belmont (84-93)

	2.0		G2502696	08.84		83.6294-0315.3	330738			L=315 L=310
	1.2	G2502697		09.91		24.5299-0309.3	331315			L=309
	1.3	G2502697		09.91		24.5298-0322.3	331314			L=322
	1.6	G2502697		09.91						
	1.6 D	G2502697		09.91						
	1.8	G2502697		09.91						
	2.0	G2502697		09.91						
	Combo			08.84	07.94					
	1.2		G5000000	08.84		83.6294-0315.3	330738			L=315
	1.3		G5000000	08.84		83.6288-0314.3	330338			L=310
	1.6		G5000000	08.84						
	1.6 D		G5000000	08.84						
	1.8		G5000000	08.84						
	1.8 Caravan		G5000000	08.84						
	2.0		G5000000	08.84						
	2.0 Limousine		G5000000	08.84						
	1.2	G5000001		09.91		24.5299-0309.3	331315			L=309
	1.3	G5000001		09.91		24.5298-0322.3	331314			L=322
	1.4			08.89	09.91					
	1.4 Limousine			08.89	09.91					
	1.5 TD			07.88	09.91					
	1.6	G5000001		09.91						
	1.6 D	G5000001		09.91						
	1.7 D			08.88	09.91					
	1.8	G5000001		09.91						
	1.8 Caravan	G5000001		09.91						
	2.0	G5000001		09.91						
	2.0 i 16V			08.87	09.91					
	2.0 Limousine	G5000001		09.91						
	2.0 i 16V Limousine			08.87	09.91	13.2351-0013.2	210010			D=35
						13.2351-0014.2	210011			ATE
						24.9235-0013.5	230001			D=35
						24.9235-0014.5	230002			ATE
						13.0441-3506.2	250052			Dichtungssatz
										ATE
	2.0 i 16V Limousine			08.87	09.91	13.0460-4043.2	604043			21140 15,0
						13.0460-0217.2	610217			Belagsatz-Zubehör
										ATE
	2.0 i 16V Limousine			08.87	09.91	24.0110-0144.1	410144			261 9,9 8,0
	1.2		G2502696	08.84		83.6267-0195.3	330737	2		L=195
	1.3		G2502696	08.84						
	1.4		G2502696	08.89						
	1.5 TD		G2502696	07.88						
	1.6		G2502696	08.84						
	1.6 D		G2502696	08.84						
	1.7 D		G2502696	08.88						
	1.8		G2502696	08.84						
	1.8 Caravan		G2502696	08.84						
	1.8 i		G2502696	08.84						
	2.0		G2502696	08.84						
	2.0 i 16V		G2502696	08.87						
	1.2 Limousine	G2502697		09.91		24.5233-0200.3	330425	2		L=198
	1.3 Limousine	G2502697		09.91						
	1.4	G2502697		09.91						
	1.5 TD	G2502697		09.91						
	1.6 D Limousine	G2502697		09.91						
	1.6 Limousine	G2502697		09.91						
	1.7 D	G2502697		09.91						
	1.8 Caravan	G2502697		09.91						
	1.8 i	G2502697		09.91						
	1.8 Limousine	G2502697		09.91						
	2.0 i 16V	G2502697		09.91						
	2.0 Limousine	G2502697		09.91						
	1.2		G5000000	08.84		83.6267-0195.3	330737	2		L=195
	1.3		G5000000	08.84						
	1.6		G5000000	08.84						
	1.6 D		G5000000	08.84						
	1.8		G5000000	08.84						
	2.0		G5000000	08.84						
	1.2 Limousine	G5000001		09.91		24.5233-0200.3	330425	2		L=198
	1.3 Limousine	G5000001		09.91						
	1.4 Limousine			08.89	09.91					
	1.5 TD Limousine			07.88	09.91					
	1.6 D Limousine	G5000001		09.91						
	1.6 Limousine	G5000001		09.91						
	1.7 D Limousine			08.88	09.91					
	1.8 Limousine	G5000001		09.91						
	2.0 Limousine	G5000001		09.91						
	diverse Typen Lim.		G5000000	08.84		24.3214-1101.3	020148		Bördel E ¹⁾	Rz 14,29
	diverse Typen Lim.		G2502696	08.84		24.3217-1102.3	020168		Bördel E ¹⁾	Rz 17,46
										LUC
										LUC

¹⁾ fiare type E / bordatura tipo E / colet E / reborde E

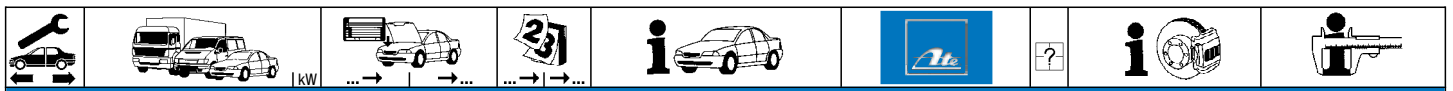

OPEL KADETT E / Vau. Astra E/Belmont (84-93)

	diverse Typen Lim.	G2502697		09.91		24.3214-1102.3	020149	Bördel F ¹⁾	Rz 14,29	LUC
	diverse Typen Lim.	G5000001		09.91		03.3217-3512.3	020032	Bördel F ¹⁾	Rz 17,46	LUC
						24.3219-1767.3	020552	+ GG/ Bördel F ²⁾	Rz 19,05	
						24.3219-1715.3	020122	+ ALU/ Bördel F ³⁾	Rz 19,05 (ALU)	
	diverse Typen Caravan		G5000000	08.84		03.3217-3503.3	020031	Bördel E ⁴⁾	Rz 17,46	
	diverse Typen Caravan		G2502696	08.84		03.3219-6301.3	020056	Bördel E/ - Druckbolzen ⁵⁾	Rz 19,05	
	diverse Typen Caravan	G2502697		09.91		24.3219-1767.3	020552	+ GG/ Bördel F/ - Druckbolzen ⁶⁾	Rz 19,05	
	diverse Typen Caravan	G5000001		09.91		24.3219-1715.3	020122	+ ALU/ Bördel F, - Druckbolzen ⁷⁾	Rz 19,05 (ALU)	
	diverse Typen Caravan			08.84	09.91	24.3219-1111.3	020194	Bördel E ⁴⁾	Rz 19,05	LUC
	1.2			08.84	09.91	03.0137-0165.2	650165	für Rz 14,29(E,F),Rz 17,46 ⁸⁾	200 x 29 HEB	LUC
	1.3 Limousine			08.84	09.91	03.0137-9054.2	669054		Bremsbacken-Zubehör	LUC
	1.4 Limousine			08.89	09.91					
	1.5 TD Limousine			08.88	09.91					
	1.6 D Limousine			08.84	09.91					
	1.6 Limousine			08.84	09.91					
	1.7 D Limousine			08.88	09.91					
	1.2 Limousine			08.84	09.91	03.0137-0166.2	650166	für Rz 17,46 ⁹⁾ ,Rz 19,05 ⁹⁾	200 x 46 HEB	LUC
	1.3 Limousine			08.84	09.91	03.0137-9060.2	669060		Bremsbacken-Zubehör	LUC
	1.4 Limousine			08.89	09.91					
	1.5 TD Limousine			08.88	09.91					
	1.6 D Limousine			08.84	09.91					
	1.6 Limousine			08.84	09.91					
	1.7 D Limousine			08.88	09.91					
	1.8 Limousine			08.84	09.91					
	2.0 Limousine			08.85	09.91					
	1.2 Caravan			08.84	09.91	03.0137-0166.2	650166	für Rz 17,46 ⁹⁾ ,Rz 19,05 ⁹⁾	200 x 46 HEB	LUC
	1.3 Caravan			08.84	09.91	03.0137-9060.2	669060		Bremsbacken-Zubehör	LUC
	1.4 Caravan			08.89	09.91					
1.5 TD Caravan			08.88	09.91						
1.6 Caravan			08.84	09.91						
1.6 D Caravan			08.84	09.91						
1.7 D Caravan			08.88	09.91						
1.2 Caravan			08.84	09.91	03.0137-0167.2	650167		230 x 51 HEB	LUC	
1.3 Caravan			08.84	09.91	03.0137-9053.2	669053		Bremsbacken-Zubehör	LUC	
1.4 Caravan			08.89	09.91						
1.5 TD Caravan			08.88	09.91						
1.6 Caravan			08.84	09.91						
1.6 D Caravan			08.84	09.91						
1.7 D Caravan			08.88	09.91						
1.8 Caravan			08.84	09.91						
2.0 Caravan			08.85	09.91						
	1.2			08.84	09.91	24.0220-0011.2	480016		200/201 x 38	
	1.3			08.84	09.91	24.0220-0001.2	480013		200/201 x 53,5	
	1.4 Limousine			08.89	09.91					
	1.5 TD Limousine			08.88	09.91					
	1.6 D Limousine			08.84	09.91					
	1.6 Limousine			08.84	09.91					
	1.7 D Limousine			08.88	09.91					
	1.8 Limousine			08.84	09.91					
	2.0 Limousine			08.85	09.91					
	1.2 Caravan			08.84	09.91	24.0220-0001.2	480013		200/201 x 53,5	
	1.3 Caravan			08.84	09.91	24.0223-0008.2	480038		230/231 x 60	
	1.4 Caravan			08.89	09.91					
	1.5 TD Caravan			08.88	09.91					
	1.6 Caravan			08.84	09.91					
1.6 D Caravan			08.84	09.91						
1.7 D Caravan			08.88	09.91						
1.8 Caravan			08.84	09.91						
2.0 Caravan			08.85	09.91						
	1.2			08.84	09.91	03.0520-0817.3	690817	Bördel F ¹⁾	17,46/200x29 TopKit	LUC
	1.3			08.84	09.91					
	1.4 Limousine			08.89	09.91					
	1.5 TD Limousine			08.88	09.91					
	1.6 D Limousine			08.84	09.91					
	1.6 Limousine			08.84	09.91					
	1.7 D Limousine			08.88	09.91					
	2.0 i 16V Limousine			08.87	09.91	03.0137-0172.2	650172		160 x 25	
						03.0137-9092.2	669092		Bremsbacken-Zubehör	
	1.2 Limousine		G2502696	08.84		24.3727-0720.2	580720	1 ↓	L=2825, + Zub	
	1.3 Limousine		G2502696	08.84						
	1.6 D Limousine		G2502696	08.84						
	1.6 Limousine		G2502696	08.84						
	1.8 Limousine		G2502696	08.84						
	2.0 N Limousine		G2502696	08.85						
	2.0 S Limousine		G2502696	08.85						
	1.2 Limousine	G2502697		09.91		24.3727-0730.2	580730	1 ↓	L=1272/1676, + Zub	
	1.3 Limousine	G2502697		09.91						
	1.6 D Limousine	G2502697		09.91						
1.6 Limousine	G2502697		09.91							
1.8 Limousine	G2502697		09.91							
2.0 N Limousine	G2502697		09.91							
2.0 S Limousine	G2502697		09.91							
	1.2 Limousine		G5000000	08.84		24.3727-0720.2	580720	1 ↓	L=2825, + Zub	
	1.3 Limousine		G5000000	08.84						

¹⁾ flare type F / bordatura tipo F / colet F / reborde F

²⁾ + CI/ flare type F / + ghis/a/ bordatura tipo F / + fonte grise/ colet F / + FG/ reborde F

³⁾ + aluminium/ flare type F / + alluminio/ bordatura tipo F / + aluminio/ colet F / + aluminio/ reborde F

⁴⁾ flare type E / bordatura tipo E / colet E / reborde E

⁵⁾ flare type E / - tappet / bordat.tipo E/ - punteria / colet E/ - boulon de pression / reborde E/ - perno de presión

⁶⁾ + CI/ flare type F / - tappet / + ghis/a/bordat.tipo F/-punter. / + fonte gr./colet F/-boul.pres. / + FG/ reborde F/-perno presión

⁷⁾ + alu/ flare type F, - tappet / + alu/ borda.tip.F,-punteria / + alu/ colet F,- boul.press. / + alum./rebor.F,-perno presión

⁸⁾ f.WC14,29(E,F),WC17,46 ⁹⁾ / per CR 14,29(E,F),CR 17,46 ⁹⁾ / pour CR 14,29(E,F),CR 17,46 ⁹⁾ / para CR14,29 (E,F),CR17,46 ⁹⁾

⁹⁾ f.WC17,46 ⁹⁾ ,WC19,05 ⁹⁾ / p.CR 17,46 ⁹⁾ ,CR 19,05 ⁹⁾ / p.CR17,46 ⁹⁾ ,CR19,05 ⁹⁾ / p.CR17,46 ⁹⁾ ,CR19,05 ⁹⁾



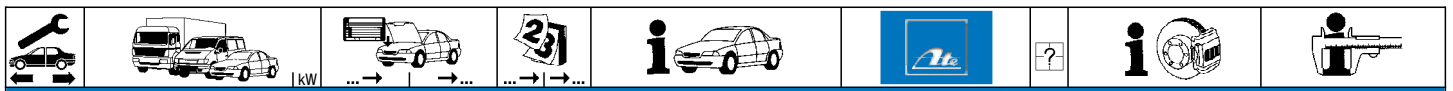

OPEL KADETT E / Vau. Astra E/Belmont (84-93)

	1.6 D Limousine		G5000000	08.84		24.3727-0720.2	580720	1	L=2825, + Zub
	1.6 Limousine		G5000000	08.84					
	1.8 Limousine		G5000000	08.84					
	2.0 N Limousine		G5000000	08.85					
	2.0 S Limousine		G5000000	08.85					
	1.2 Limousine	G5000001		09.91		24.3727-0730.2	580730	1	L=1272/1676, + Zub
	1.3 Limousine	G5000001		09.91					
	1.4 Limousine			08.89	09.91				
	1.5 TD Limousine			07.88	09.91				
	1.6 D Limousine	G5000001		09.91					
	1.6 Limousine	G5000001		09.91					
	1.7 D Limousine			08.88	09.91				
	1.8 Limousine	G5000001		09.91					
	2.0 N Limousine	G5000001		09.91					
	2.0 S Limousine	G5000001		09.91					
	1.2 Caravan			08.84	09.91 + Schaltgetriebe ¹⁾	24.3727-0732.2	580732	1	L=1288/1398, + Zub
	1.3 Caravan			08.84	09.91 + Schaltgetriebe ¹⁾				
	1.5 TD Caravan			07.88	09.91 + Schaltgetriebe ¹⁾				
	1.7 D Caravan			08.89	09.91 + Schaltgetriebe ¹⁾				
	2.0 Caravan			09.87	09.91 + Schaltgetriebe ¹⁾				
	1.2 Caravan			08.84	09.91 + Automatikgetriebe ²⁾	24.3727-0741.2	580741	1	L=1285/1395, + Zub
	1.3 Caravan			08.84	09.91 + Automatikgetriebe ²⁾				
	1.4 Caravan			08.84	09.91				
	1.5 TD Caravan			07.88	09.91 + Automatikgetriebe ²⁾				
	1.6 Caravan			08.84	09.91				
	1.6 D Caravan			08.84	09.91				
	1.7 D Caravan			08.89	09.91 + Automatikgetriebe ²⁾				
	1.8 Caravan			08.84	09.91				
	2.0 Caravan			09.87	09.91 + Automatikgetriebe ²⁾				
		1.2 Caravan	G2502697		09.91		03.6565-0130.3	320098	
1.2 Caravan		G5000001		09.91					
1.3 Caravan		G2502697		09.91					
1.3 Caravan		G5000001		09.91					
1.4 Caravan				08.89	09.91				
1.5 TD Caravan				07.88	09.91				
1.6 Caravan		G2502697		09.91					
1.6 Caravan		G5000001		09.91					
1.6 Caravan		G5000001		09.91					
1.6 D Caravan		G2502697		09.91					
1.7 D Caravan			08.88	09.91					
1.8 Caravan	G2502697		09.91	Ch. G5000001 -					
1.8 Caravan	G5000001		09.91						
2.0 Caravan	G2502697		09.91	Ch. G5000001 -					
2.0 Caravan	G5000001		09.91						
	1.2			08.84	09.91	24.3728-0711.2	590711		L=815
	1.3			08.84	09.91				
	1.4			08.89	09.91				
	1.5 TD			07.88	09.91				
	1.6			08.84	09.91				
	1.6 D			08.84	09.91				
	1.7 D			08.88	09.91				
	1.8			08.84	09.91				
	2.0			08.84	09.91				

OPEL KAPITÄN (55-63)

	2.5	55		05.55	12.58	13.0460-6027.2	606027		20011 15,0 ATE
	P 2.6	66		05.58	12.63				

OPEL KAPITÄN A (64-69)

	4.6 V8	140		04.65	03.69	24.0113-0126.1	413126		271 12,7 9,7
--	--------	-----	--	-------	-------	----------------	--------	--	--------------

OPEL MANTA A (70-75)

	1.2	2761365		08.75		03.2120-1981.3	010105		+ Behälter ³⁾	THz 20,64	DEL
	1.2	9662825		08.75							
	1.6	2761365		08.75							
	1.6	9662825		08.75							
	1.9	2761365		08.75							
	1.2			01.70	08.75	13.0460-4035.2	604035		20173 15,0	ATE	
	1.6			01.70	08.75	13.0460-0038.2	610038		Belagsatz-Zubehör	ATE	
	1.6 N			01.70	08.75						
	1.9			01.70	08.75						
	1.2		51019912	01.70		24.0111-0116.1	411116		238 11,0 8,0		
	1.6		51019912	01.70							
	1.6 N		51019912	01.70							
	1.9		51019912	01.70							
	1.2	51019913		08.75		24.0113-0125.1	413125		246 12,7 9,7		
	1.6	51019913		08.75							
	1.6 N	51019913		08.75							
	1.9	51019913		08.75							

¹⁾ + manual transmission / + scatola cambio velocità / + transmission mécanique / + cambio de velocidad
²⁾ + autom.transmission / + scatola cambio automatico / + transmission automatique / + cambio automático
³⁾ + reservoir / + serbatoio / + réservoir / + recipiente



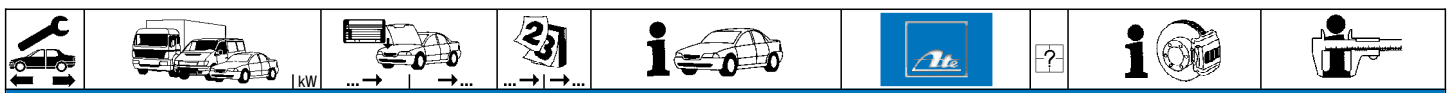

OPEL MANTA A (70-75)									
	1.6 S		9662824	01.70		03.3215-1701.3	020015		Rz 15,87
	1.6 S		2761436	01.70					
	1.9		9662824	01.70					
	1.9		2761436	01.70					
	1.6 N	2724058			08.75 + (N)	03.3219-4202.3	020050		Rz 19,05
	1.6 S	2761437			08.75				
	1.6 S	9662825			08.75				
	1.9	2761437			08.75				
	1.9	9662825			08.75				
	1.6 N			01.70	08.75 + Automatikgetriebe 1)	03.0137-0108.2	650108		230 x 51 HEB
	1.6 S	2560700			08.75	03.0137-9014.2	669014		Bremsbacken-Zubehör
	1.9			01.70	08.75				
	1.2			01.70	08.75	24.0220-0001.2	480013		200/201 x 53,5
	1.6 N		2453080	01.70	08.75	24.0223-0008.2	480038		230/231 x 60
	1.6 S			01.70	08.75				
	1.9			01.70	08.75				
	1.6 N	2453081			08.75	24.0220-0001.2	480013		200/201 x 53,5

OPEL MANTA B / Vauxhall Cavalier Coupe (76-88)										
	1.2	◀		09.75	07.85	03.2120-1981.3	010105	+ Behälter 2)	Thz 20,64	DEL
	1.3	◀		01.80	07.85					
	1.6	◀		09.75	12.82					
	1.8	◀		01.82	07.85					
	1.9	◀		09.75	11.77					
	2.0	◀		12.77	07.85					
	1.2	▶		09.77	08.81	03.2120-0538.3	010077		Thz 20,64	ATE
	1.3	▶		01.80	07.85					
	1.6	▶		09.77	12.82					
	1.8	▶		01.82	07.85					
	1.9	▶		09.77	11.77					
	2.0	▶		12.77	07.85					
	1.2	◀		10.76	12.77	03.3508-7504.3	310045		Behälter	ATE
	1.6	◀		10.76	12.77					
	1.9	◀		10.76	11.77					
	1.2			09.75	07.81 + Festsättel 3)	13.0441-4825.2	250107		Dichtungssatz	ATE
	1.3			01.80	07.81 + Festsättel 3)					
	1.6			09.75	07.81 + Festsättel 3)					
	1.9			09.75	11.77 + Festsättel 3)					
	2.0			12.77	07.81 + Festsättel 3)					
	1.2			09.78	08.81 + Faustsättel 4)	24.0101-4801.2	990131		Bremssattel-Zubehör	DEL
	1.3			01.80	12.86 + Faustsättel 4)					
	1.6			09.78	12.82 + Faustsättel 4)					
	1.8			01.82	12.88 + Faustsättel 4)					
	2.0			09.78	12.88 + Faustsättel 4)					
	1.2			09.75	07.81 + Festsättel 3)	13.0460-5030.2	605030		20323 16,5	ATE
	1.3			01.80	07.81 + Festsättel 3)					
	1.6			09.75	07.81 + Festsättel 3)					
	1.9			09.75	11.77 + Festsättel 3)					
	2.0			12.77	07.81 + Festsättel 3)					
	1.2			09.78	12.88 + Faustsättel 4)	13.0460-7048.2	607048		20939 15,8 /WE	DEL
	1.3			01.80	12.86 + Faustsättel 4)	13.0460-0127.2	610127		Belagsatz-Zubehör	DEL
	1.6			09.78	12.82 + Faustsättel 4)					
	1.8			01.82	12.88 + Faustsättel 4)					
2.0			09.78	12.88 + Faustsättel 4)						
	Manta 400 i			08.81	07.86	13.0460-7048.2	607048		20939 15,8 /WE	DEL
	1.2			09.75	08.81	24.0113-0125.1	413125		246 12,7 9,7	
	1.3			01.80	12.86					
	1.6			09.75	12.82					
	1.8			01.82	12.88					
	1.9			09.75	11.77					
	2.0			12.77	12.88					
	Manta 400 i			08.81	07.86	24.0122-0109.1	422109		271 22,0 19,0 V	
	1.6 S			09.75	12.82	03.3219-4202.3	020050		Rz 19,05	
	1.8			01.82	12.88					
	1.9			09.75	11.77					
	2.0			12.77	12.88					
	Manta 400 i			08.81	07.86					
	1.3 S			01.80	06.83 + Automatikgetriebe 1)	03.0137-0108.2	650108		230 x 51 HEB	
	1.6 N			09.75	12.82 + Automatikgetriebe 1)	03.0137-9014.2	669014		Bremsbacken-Zubehör	
	1.6 S			09.75	12.82					
	1.8			01.82	06.83					
	1.9			09.75	11.77					
	2.0			12.77	06.83					
	1.3 S			07.83	12.86 + Automatikgetriebe 1)	03.0137-0167.2	650167		230 x 51 HEB	LUC
	1.8			07.83	12.88	03.0137-9053.2	669053		Bremsbacken-Zubehör	LUC
	2.0			07.83	12.88					
	Manta 400 i			08.81	07.86					
	1.2			09.75	08.81	24.0220-0001.2	480013		200/201 x 53,5	
	1.3 N			01.80	08.81 + Schaltgetriebe 5)					
	1.6 N			09.75	08.81 + Schaltgetriebe 5)					
	1.3 S			01.80	12.86	24.0223-0008.2	480038		230/231 x 60	
	1.6 N			09.75	12.82 + Automatikgetriebe 1)					
	1.6 S			09.75	12.82					
1.8			01.82	12.88						

1) + autom.transmission / + scatola cambio automatico / + transmission automatique / + cambio automático











2) + reservoir / + serbatoio / + réservoir / + recipiente

3) + fixed calipers / + pinze freno fisse / + étriers fixes / + pinza de fija

4) + fist type calipers / + pinza freno flottante / + étriers à griffe / + pinza de puno

5) + manual transmission / + scatola cambio velocità / + transmission mécanique / + cambio de velocidad



OPEL MANTA B / Vauxhall Cavalier Coupe (76-88)												
	1.9 2.0			09.75 12.77	11.77 12.88			24.0223-0008.2	480038		230/231 x 60	
OPEL OMEGA A / Vauxhall Carlton (87-93)												
	1.8 Limousine	◀		08.86	08.93	- ABS		03.2022-0602.3	010006		Thz 22,20/19,05 ATE	
	2.3 D Limousine	◀		08.86	08.93	- ABS						
	2.3 TD Limousine	◀		08.86	08.93	- ABS						
	1.8 Caravan	◀		08.86	08.93	- ABS		03.2022-0702.3	010007		Thz 22,20/19,05 ATE	
	2.0	◀		08.86	08.93	- ABS						
	2.3 D Caravan	◀		08.86	08.93	- ABS						
	2.3 TD Caravan	◀		08.86	08.93	- ABS						
	2.4	◀		08.88	08.93	- ABS						
	1.8	◀		08.86	08.93	+ ABS		03.2022-1402.3	010010		Thz 22,20/19,05 ATE	
	2.0	◀		08.86	08.93	+ ABS						
	2.3 D	◀		08.86	08.93	+ ABS						
	2.3 TD	◀		08.86	08.93	+ ABS						
	2.4	◀		08.88	08.93	+ ABS						
	2.6	◀		09.90	08.93			03.2023-0642.3	010026		Thz 23,81/20,64 ATE	
	3.0	◀		08.86	08.93							
3.0 24V	◀		08.89	08.93								
	1.8	▶		08.86	08.93	+ ABS		03.2022-1602.3	010011		Thz 22,20/19,05 ATE	
	2.0	▶		08.86	08.93	+ ABS						
	2.3 D	▶		08.86	08.93	+ ABS						
	2.3 TD	▶		08.86	08.93	+ ABS						
	2.4	▶		08.88	08.93	+ ABS						
	1.8		L1019854	08.86				24.0101-4801.2	990131		Bremssattel-Zubehör DEL	
	2.3 D		L1019854	08.86								
	2.3 TD		L1019854	08.86								
	2.0		K1000098	08.86				24.0101-4801.2	990131		Bremssattel-Zubehör DEL	
								11.0101-5407.2	260011		Hülzensatz ATE	
								11.8171-0008.1	990049		Führungsbolzen ATE	
								11.8116-0097.1	390590	2	Haltefeder ATE	
	1.8		L1019855		08.93			11.0441-5402.2	250028		Dichtungssatz ATE	
	2.0		K1000099		08.93			11.0101-5407.2	260011		Hülzensatz ATE	
	2.3 D		L1019855		08.93			11.8171-0008.1	990049		Führungsbolzen ATE	
2.3 TD		L1019855		08.93			11.8116-0097.1	390590	2	Haltefeder ATE		
2.4		K1000099		08.93								
	3.0		M1000000	08.86				11.0441-6003.2	250037		Dichtungssatz ATE	
								11.0101-5407.2	260011		Hülzensatz ATE	
								11.8171-0008.1	990049		Führungsbolzen ATE	
	2.6			09.90	08.93			24.3571-1705.5	240069		D=57, - Halter LUC	
	3.0		M1000001		08.93			24.3571-1706.5	240070		D=57, - Halter LUC	
	3.0 24V			08.89	08.93			24.0101-3401.2	260043		Bremssattel-Zubehör LUC	
		1.8		L1019854	08.86				13.0460-7048.2	607048		20939 15,8 /WE DEL
		2.3 D		L1019854	08.86				13.0460-0127.2	610127		Belagsatz-Zubehör DEL
		2.3 TD		L1019854	08.86				13.0460-0205.2	610205		Belagsatz-Zubehör DEL
									24.8190-0712.2	620712	2	Warnkontakt L=660mm
		2.0		K1000098	08.86				13.0460-7052.2	607052	2	21190 17,5 +/-WE ATE
									24.8190-0947.2	620947	2	Nur bei Umbau von DELCO in ATE Warnkontakt L=865mm ATE
									13.0460-7048.2	607048		20939 15,8 /WE DEL
									13.0460-0205.2	610205		Belagsatz-Zubehör DEL
									24.8190-0702.2	620702	2	Warnkontakt L=860mm DEL
1.8			L1019855		08.93			13.0460-7052.2	607052	2	21190 17,5 +/-WE ATE	
2.0			K1000099		08.93			24.8190-0706.2	620706	2	Warnkontakt L=660mm ATE	
2.3 D			L1019855		08.93							
2.3 TD			L1019855		08.93							
2.4			K1000099		08.93							
		3.0		M1000000	08.86				24.8190-0703.2	620703	2	Warnkontakt L=860mm
	2.6			09.90	08.93			13.0460-2815.2	602815		21368 18,3 /WE/S LUC	
	3.0		M1000001		08.93			24.8190-0716.2	620716	2	Warnkontakt L=680mm	
	3.0 24V			08.89	08.93							
		1.8		L1019854	08.86		- ABS		24.0113-0174.1	413174		258 12,6 9,7
		2.3 D		L1019854	08.86		- ABS					
		2.3 TD		L1019854	08.86		- ABS					
		1.8		L1019854	08.86		+ ABS		24.0124-0111.1	424111		258 24,0 21,0 V +B
		1.8		L1019855		08.93						
		2.0			08.86	08.93						
		2.3 D		L1019854		08.86	+ ABS					
		2.3 D		L1019855		08.93						
		2.3 TD		L1019854	08.86		+ ABS					
		2.3 TD		L1019855		08.93						
		2.4			08.88	08.93						
3.0			M1000000	08.86				24.0124-0110.1	424110		280 24,0 21,0 V	
2.6				09.90	08.93			24.0128-0104.1	428104		296 28,0 25,0 V L +S +B	
3.0			M1000001		08.93							
3.0 24V				08.89	08.93							
	1.8 Limousine		K1000098	08.86				13.0441-3506.2	250052		Dichtungssatz ATE	
	2.0 Limousine		K1000098	08.86								
	2.3 D Limousine		K1000098	08.86								
	2.3 TD Limousine		K1000098	08.86								
	1.8 Limousine		K1000099		08.93			13.0441-3506.2	250052		Dichtungssatz ATE	
	2.0 Limousine		K1000099		08.93							
	2.3 D Limousine		K1000099		08.93							

1) - ventilated discs/ - ABS / - dischi ventilati, - ABS / - disques ventilés, - ABS / - disco ventilado, - ABS
2) + ventilated discs/ + ABS / + dischi ventilati/ + ABS / + disques ventilés/ + ABS / + disco ventilado/ + ABS



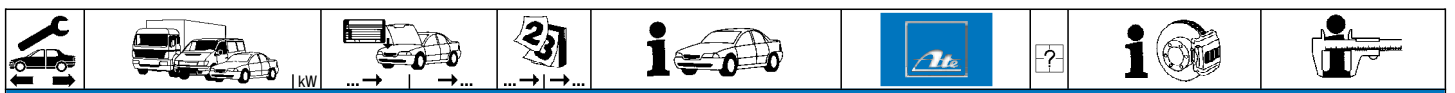

OPEL OMEGA A / Vauxhall Carlton (87-93)

	2.3 TD Limousine 2.4 Limousine	K1000099 K1000099		08.93 08.93		13.0441-3506.2	250052		Dichtungssatz	ATE
	1.8 Limousine 2.0 Limousine 2.3 D Limousine 2.3 TD Limousine		K1000098 K1000098 K1000098 K1000098	08.86 08.86 08.86 08.86		13.0460-0436.2	610436		Belagsatz-Zubehör	ATE
	1.8 Caravan 1.8 Limousine 2.0 Caravan 2.0 Limousine 2.3 D Caravan 2.3 D Limousine 2.3 TD Caravan 2.3 TD Limousine 2.4 2.6 3.0 3.0 24V	K1000099 K1000099 K1000099 K1000099		08.86 08.93 08.86 08.93 08.86 08.93 08.86 08.93 08.88 08.93 08.86 08.93 08.89 08.93		13.0460-4040.2 13.0460-0198.2	604040 610198		21050 15,8 Belagsatz-Zubehör	ATE ATE
	1.8 2.0 2.3 D 2.3 TD 2.4 2.6 3.0 3.0 24V			08.86 08.86 08.86 08.86 08.88 08.93 08.86 08.93 08.89 08.93		24.0110-0191.1	410191		270 10,0 8,0 +B	
	1.8 2.0 2.3 D 2.3 TD 2.4 2.6 3.0 3.0 24V			08.86 08.86 08.86 08.86 08.88 08.93 08.86 08.93 08.89 08.93		24.5233-0200.3	330425	2	L=198	
	1.8 2.0 2.3 D 2.3 TD 2.4 2.6 3.0 3.0 24V			08.86 08.86 08.86 08.86 08.88 08.93 08.86 08.93 08.89 08.93		03.0137-0172.2 03.0137-9092.2	650172 669092		160 x 25 Bremsbacken-Zubehör	
	1.8 2.0 2.3 D 2.3 TD 2.4 2.6 3.0 3.0 24V			08.86 08.86 08.86 08.86 08.88 08.93 08.86 08.93 08.89 08.93	- langer Radstand ¹⁾ - langer Radstand ¹⁾ - langer Radstand ¹⁾ - langer Radstand ¹⁾ - langer Radstand ¹⁾ - langer Radstand ¹⁾ - langer Radstand ¹⁾ - langer Radstand ¹⁾	24.3727-0725.2	580725	1 ↓	L=1550/1550, + Zub	
	2.6 3.0 3.0 24V	M1000001		09.90 08.93 08.89 08.93		24.2419-0938.3	030064		Gz 19,05	
	2.6 3.0 3.0 24V	M1000001		09.90 08.93 08.89 08.93		24.2520-0904.3	040037		Nz 20,64	
	1.8 2.0			08.86 08.86	Getriebe-Nr. - 187545-87 ²⁾ Getriebe-Nr. - 187545-87 ²⁾	24.3728-0714.2	590714		L=1190	
	1.8 2.0			08.93 08.93	Getriebe-Nr. 187546-87 - ³⁾ Getriebe-Nr. 187546-87 - ³⁾	24.3728-0719.2	590719		L=1226	
	2.3 D 2.3 TD 2.4 3.0	H1085389 H1085389 K1000099	L1999999	08.93 08.93 08.88 08.93		24.3728-0717.2	590717		L=1248	

OPEL REKORD A (63-65)

























	1500 1700 1700 1700 1700 Coupe 2600 Coupe	40 44 49 55 49 74		02.63 12.65 02.63 12.65 02.63 12.65 04.64 12.65 01.63 12.65 05.64 12.65		13.0460-4033.2	604033		20034 15,0	ATE
	1500 1700 1700 1700 1700 Coupe 2600 Coupe	40 44 49 55 49 74		02.63 12.65 02.63 12.65 02.63 12.65 04.64 12.65 01.63 12.65 05.64 12.65		24.0111-0116.1	411116		238 11,0 8,0	

OPEL REKORD B (65-67)







	1.9 1.9 Coupe	66 66		08.65 12.66 08.65 02.67		13.0460-6027.2	606027		20011 15,0	ATE
	1.5 1.5 Caravan	44 44		08.65 12.66 08.65 12.66		13.0460-4033.2	604033		20034 15,0	ATE

¹⁾ - long wheel base / - passo lungo / - empattement long / - distancia larga entre ejes
²⁾ transm.no. - 187545-87 / scatola cambio n. - 187545-87 / no.boîte vitesse - 187545-87 / no.de cambio - 187545-87
³⁾ transm.no. 187546-87 - / scatola cambio n. 187546-87 - / no.boîte vitesse 187546-87 - / no.de cambio 187546-87 -



								
OPEL REKORD B (65-67)								
	1.7 1.7 Caravan 1.7 Coupe 1.9	55 55 55 55		08.65 08.65 08.65 09.65	12.66 12.66 12.66 12.66	13.0460-4033.2 604033		20034 15,0 ATE
	1.5 1.5 Caravan 1.7 1.7 Caravan 1.7 Coupe 1.9 1.9 Coupe	44 44 55 55 55 66 66		08.65 08.65 08.65 08.65 08.65 09.65 08.65	12.66 12.66 12.66 12.66 12.66 12.66 02.67	24.0111-0116.1 411116		238 11,0 8,0
OPEL REKORD C (66-71)								
	1.5 1.5 Caravan 1.5 Caravan 1.7 1.7 1.7 Caravan 1.7 Caravan 1.7 S 1.7 S Caravan 1.7 S Coupe 1.9 1.9 Caravan 1.9 Coupe 1.9 Sprint 2.2	43 43 44 44 49 44 49 55 55 55 66 66 66 78 70		08.66 08.66 02.68 08.66 02.68 08.66 08.66 08.66 08.66 08.66 08.66 08.66 08.67 08.66	12.71 12.71 12.71 12.71 12.71 12.71 12.71 12.71 12.71 12.71 12.71 12.71 12.71 12.71	13.0460-4033.2 604033		20034 15,0 ATE
	1.5 1.5 Caravan 1.5 Caravan 1.7 1.7 1.7 Caravan 1.7 Caravan 1.7 S 1.7 S Caravan 1.7 S Coupe 1.9 1.9 Caravan 1.9 Coupe 2.2 1.9 Sprint	43 43 44 44 49 44 49 55 55 55 66 66 66 70 78		08.66 08.66 02.68 08.66 02.68 08.66 02.68 08.66 08.66 08.66 08.66 08.66 08.66 08.66 08.67	12.71 12.71 12.71 12.71 12.71 12.71 12.71 12.71 12.71 12.71 12.71 12.71 12.71 12.71 12.71	24.0111-0116.1 411116		238 11,0 8,0
	1.5 1.5 Caravan 1.5 Caravan 1.7 1.7 1.7 Caravan 1.7 Caravan 1.7 S 1.7 S Caravan 1.7 S Coupe 1.9 1.9 Caravan 1.9 Coupe 2.2 1.9 Sprint	43 43 44 44 49 44 49 55 55 55 66 66 66 70 78		08.66 08.66 02.68 08.66 02.68 08.66 02.68 08.66 08.66 08.66 08.66 08.66 08.66 08.66 08.67	12.71 12.71 12.71 12.71 12.71 12.71 12.71 12.71 12.71 12.71 12.71 12.71 12.71 12.71 12.71	24.0113-0126.1 413126		271 12,7 9,7
OPEL REKORD D / Vauxhall Carlton (72-77)								
	1.7 S 1.9 2.0 2.0 D			01.74 01.74 01.75 08.74	12.77 + (OK) 12.77 12.77 12.77	03.2120-1981.3 010105	+ Behälter 1)	THz 20,64 DEL
	1.7 1.9 2.0 2.1 D			01.72 01.72 01.75 01.72	12.77 12.77 12.77 12.77	03.3508-7504.3 310045		Behälter ATE
	1.7 1.9 2.0 2.1 D			01.72 01.72 01.75 01.72	12.77 12.77 12.77 12.77	13.0441-4825.2 250107		Dichtungssatz ATE
	1.7 1.9 2.1 D			01.72 01.72 01.72	09.73 09.73 09.73	13.0460-4035.2 604035 13.0460-0038.2 610038		20173 15,0 Belagsatz-Zubehör ATE ATE
	1.7 1.9 2.0 2.1 D			10.73 10.73 01.75 10.73	12.77 12.77 12.77 12.77	13.0460-5030.2 605030		20323 16,5 ATE
	1.7 Limousine 1.9 Limousine 2.1 D Caravan 2.1 D Limousine		51041820 51041820 5860629 5861688	01.72 01.72 01.72 01.72		24.0111-0116.1 411116		238 11,0 8,0
	1.7 Limousine 1.9 Limousine 2.0 Limousine 2.1 D Caravan 2.1 D Limousine	51041821 51041821 5860630 5861689			12.77 12.77 12.77 12.77 12.77	24.0113-0125.1 413125		246 12,7 9,7
	1.7 2.1 D			01.72 01.72	12.77 - (S) 09.73	03.3215-1701.3 020015		Rz 15,87
	1.7 1.9 2.0 2.1 D			01.72 01.72 01.75 10.73	12.77 + (S) 12.77 12.77 12.77	03.3219-4202.3 020050		Rz 19,05
	1.7 1.9 2.0 2.1 D			01.72 01.72 01.75 01.72	12.77 12.77 12.77 12.77	03.0137-0108.2 650108 03.0137-9014.2 669014		230 x 51 HEB Bremsbacken-Zubehör

1) + reservoir / + serbatoio / + réservoir / + recipiente

OPEL REKORD D / Vauxhall Carlton (72-77)											
	1.7 1.9 2.0 2.1 D			01.72 01.72 01.75 01.72	12.77 12.77 12.77 12.77	24.0223-0008.2	480038			230/231 x 60	
OPEL REKORD E / Vauxhall Carlton (77-86)											
	1.7 1.9 2.0 D 2.1 D 2.3 D			01.77 01.77 01.81 01.77 01.79	09.82 09.82 09.82 12.80 09.82	03.2120-0538.3	010077			THz 20,64	ATE
	1.7 1.8 1.9 2.0 2.0 D 2.3 D			10.82 10.82 10.82 10.82 10.82	08.84 08.84 08.84 08.84 08.84	03.2122-8806.3 03.3510-0059.1	010157 390270		bis 08.83 mitverwenden 1)	THz 22,20 Schraubstützen	ATE ATE
	1.7 1.9 2.0 2.0 D Limousine 2.1 D Limousine 2.3 D Limousine			01.77 01.77 01.77 01.81 01.77 01.79	10.82 + verstärkte Bremse 2) 10.82 + verstärkte Bremse 2) 10.82 12.82 + Automatikgetriebe 4) 12.80 + Automatikgetriebe 4) 10.82 + Automatikgetriebe 4)	03.2120-1981.3	010105		Kennzeichen: H/ + Behälter 3)	THz 20,64	DEL
	1.7 1.9 2.0 2.0 D 2.1 D 2.3 D			01.77 01.77 01.77 01.81 01.77 01.79	09.82 + Festsättel 5) 09.82 + Festsättel 5) 09.82 + Festsättel 5) 09.82 + Festsättel 5) 12.80 + Festsättel 5) 09.82 + Festsättel 5)	13.0441-4825.2	250107			Dichtungssatz	ATE
	1.7 1.9 2.0 2.0 D 2.1 D 2.3 D	D1000028 D1000028 D1000028 D1000028 D1000028	01.79 01.79 01.79 01.81 01.79	+ Faustsättel 6) + Faustsättel 6) + Faustsättel 6) + Faustsättel 6) + Faustsättel 6)		11.0441-4803.2 11.0101-4802.2	250018 260007			Dichtungssatz Hülensatz	ATE ATE
	2.0 E 2.2 E	F1000189 F1076856	09.85 12.86	- ABS/ - verstärkte Bremse 7)		11.0101-4802.2	260007			Hülensatz	ATE
	alle Typen alle Typen alle Typen		01.84 01.77 01.77	+ ABS + verstärkte Bremse 2) - ABS/ + verstärkte Bremse 6)		11.0101-4802.2 24.0101-4801.2	260007 990131			Hülensatz Bremsattel-Zubehör	ATE DEL
	alle Typen alle Typen		01.77 01.79	+ Festsättel 5) + Faustsättel 6)		13.0460-5030.2 13.0460-7048.2 13.0460-0127.2 13.0460-0205.2	605030 607048 610127 610205		- belüftete Scheiben 9) + belüftete Scheiben 10)	20939 15,8 /WE Belagsatz-Zubehör Belagsatz-Zubehör	DEL DEL DEL
	1.7 1.8 1.9 2.0 2.0 D 2.0 E 2.1 D 2.3 D 2.3 TD	D1000029	F1000188	01.77 10.82 01.77 01.77 01.81 01.77 01.79 01.84	12.86 - ABS/ - verstärkte Bremse 7) 12.86 - ABS/ - verstärkte Bremse 7) 12.86 - ABS/ - verstärkte Bremse 7) 12.86 - ABS/ - verstärkte Bremse 7) 12.83 - ABS 12.83 - ABS 12.80 - ABS 12.86 - ABS/ - verstärkte Bremse 7) 12.86 - ABS/ - verstärkte Bremse 7)	24.0113-0125.1	413125			246 12,7 9,7	
	2.0 E 2.2 E	F1000189	F1076856	09.85 12.86	- ABS - ABS	24.0123-0100.1	423100			246 23,0 21,0 V	ATE
	2.0 E	F1076857		12.86	- ABS	24.0113-0125.1	413125			246 12,7 9,7	
	1.7 1.8 1.9 2.0 2.0 D 2.1 D 2.2 E 2.3 D 2.3 TD			01.77 10.82 01.77 01.77 01.81 01.77 09.85 01.79 01.84	09.82 + Festsättel 5) 12.86 + Festsättel 5) 09.82 + Festsättel 5) 09.82 + Festsättel 5) 09.82 + Festsättel 5) 12.80 + Festsättel 5) 12.86 + Festsättel 5) 09.82 + Festsättel 5) 12.86 + Festsättel 5)	83.6267-0285.3	330332	2		L=285	
	1.7 Limousine 1.8 N Limousine 1.9 Limousine			01.77 10.82 01.77	- verstärkte Bremse 11) - verstärkte Bremse 11) - verstärkte Bremse 11)	03.3215-1701.3	020015			Rz 15,87	
	1.7 Limousine 1.8 N Limousine 1.9 Limousine 2.0 D Limousine 2.0 Limousine 2.1 D Limousine 2.3 D Limousine	F1000188 F1000188 F1000188	01.77 10.82 01.77 01.81 01.77 01.77 01.79	+ verstärkte Bremse 2) + verstärkte Bremse 2) + verstärkte Bremse 2) - S		03.3219-4202.3	020050			Rz 19,05	
	1.7 Limousine 1.8 Limousine 1.9 Limousine 2.0 D Limousine 2.0 Limousine 2.2 E 2.3 D Limousine 2.3 TD Limousine	F1000189 F1000189 F1000189 F1000189 F1000128	10.82 09.85 10.82 09.84	12.86 12.86 12.86 12.83 12.86 12.86		24.3219-1111.3	020194			Rz 19,05	LUC
	1.7 Caravan 1.8 Caravan	F1000188 F1000188	01.77 10.82			03.3222-6903.3	020084			Rz 22,20	

1) reuse up to 08.83 / riutilizzare fino a 08.83 / utiliser jusqu'au 08.83 / hasta 08.83 emplear

2) + heavy duty brake / + freno reforzado / + frein renforcé / + freno reforzado

3) registration no.:H/ + reservoir / targa: H/ + serbatoio / indice: H/ + réservoir / distintivo: H/ + recipiente

4) + autom.transmission / + scatola cambio automatico / + transmission automatique / + cambio automático

5) + fixed calipers / + pinze freno fisse / + étriers fixes / + pinza de fija

6) + fist type calipers / + pinza freno flottante / + étriers à griffe / + pinza de puno















7) - ABS/ - heavy duty brake / - ABS/ - freno reforzado / - ABS/ - frein renforcé / - ABS/ - freno reforzado

8) - ABS/ + heavy duty brake / - ABS/ + freno reforzado / - ABS/ + frein renforcé / - ABS/ + freno reforzado

9) - ventilated discs / - dischi ventilati / - disques ventilés / - disco ventilado

10) + ventilated discs / + dischi ventilati / + disques ventilés / + disco ventilado

11) - heavy duty brake / - freno reforzado / - frein renforcé / - freno reforzado

OPEL REKORD E / Vauxhall Carlton (77-86)											
	1.9 Caravan 2.0 Caravan 2.0 D Caravan 2.0 E 2.1 D Caravan 2.3 D Caravan		F1000188 F1000188 F1000188	01.77 01.77 01.81 01.77 01.77 01.79	12.83 12.86 + ⑤ 12.80		03.3222-6903.3 	020084			Rz 22,20
	1.7 1.9 2.0 2.0 D 2.1 D 2.3 D			01.77 01.77 01.77 01.81 01.77 01.79	07.82 07.82 07.82 07.82 12.80 07.82		03.0137-0108.2 03.0137-9014.2	650108 669014		- autom. Nachstellung 1)	230 x 51 HEB Bremsbacken-Zubehör
	1.7 1.8 1.9 2.0 2.0 D 2.2 E 2.3 D 2.3 TD			08.82 10.82 08.82 08.82 08.82 09.85 08.82 09.84	12.86 12.86 12.86 12.86 12.83 12.86 12.86 12.86		03.0137-0167.2 03.0137-9053.2	650167 669053		+ autom. Nachstellung 2)	230 x 51 HEB Bremsbacken-Zubehör LUC
	1.7 1.8 1.9 2.0 2.0 D 2.1 D 2.2 E 2.3 D 2.3 TD			01.77 10.82 01.77 01.77 01.81 01.77 09.85 01.79 09.84	12.86 12.86 12.86 12.86 12.83 12.80 12.86 12.86 12.86		24.0223-0008.2	480038			230/231 x 60
	diverse Typen Caravan			01.77	12.86		03.0101-0014.2	320004			BRES 3/25 ATE
	1.7 2.0 2.2 E 1.8	D1000029 			12.86 09.85 09.85 10.82		24.3728-0706.2 24.3728-0709.2	590706 590709			L=1005 L=1020
OPEL SENATOR A/MONZA / Vaux. Royal (78-87)											
	2.0 2.5 2.8 3.0		E1000072 E1000072 E1000072	12.82 06.78 06.78 06.78			03.2123-4911.3	010182			THz 23,81 ATE
	2.5 2.8 3.0		11110928 11110928 11110928	06.78 06.78 06.78			13.0441-5411.2	250114			Dichtungssatz ATE
	2.0 2.2 2.3 TD 2.5 3.0	E1019586 E1019586 E1019586			12.84 10.84 11.84 11.84 08.87 08.87	- Klimaanlage 3) + Klimaanlage 4)	11.0441-4803.2 11.0101-4802.2 11.0441-6003.2 11.0101-5407.2 11.8171-0008.1	250018 260007 250037 260011 990049			Dichtungssatz Hülsensatz Dichtungssatz Hülsensatz Führungsbolzen ATE ATE ATE ATE
	2.0 2.5 2.8 3.0		E1019585 E1019585 E1019585 E1019585	12.82 06.78 06.78 06.78		+ Festsättel 5) + Festsättel 5) + Festsättel 5) + Festsättel 5)	13.0460-4048.2 13.0460-0165.2	604048 610165		+ belüftete Scheiben 6)	20011 15,0 /WE Belagsatz-Zubehör ATE ATE
	2.0 2.5 2.8 3.0		E1019585 E1019585 E1019585 E1019585	12.82 06.78 06.78 06.78		+ Klimaanlage 4)	24.0122-0109.1	422109			271 22,0 19,0 V
	2.0 2.2 2.3 TD 2.5 3.0	E1019586 E1019586 E1019586			10.84 08.87 11.84 08.87 08.87 08.87		24.0122-0126.1	422126			271 22,0 19,0 V
	2.0 2.2 2.3 TD 2.5 2.8 3.0		E1019585 E1019585 E1019585 E1019585 E1019585 E1019585	06.78 06.78 11.84 06.78 06.78 06.78			83.6267-0285.3	330332	2		L=285
	2.0 2.2 2.3 TD 2.5 2.8 3.0			12.82 11.84 11.84 06.78 06.78 06.78	10.84 08.87 08.87 08.87 04.81 08.87		03.0137-0172.2 03.0137-9092.2	650172 669092			160 x 25 Bremsbacken-Zubehör
OPEL SENATOR B / Vauxhall Royal (88-93)											
	2.5 2.6 3.0 3.0 24V			09.90 08.90 09.87 08.89	09.93 + ABS 09.93 + ABS 09.93 + ABS 09.93 + ABS		03.2023-0642.3	010026			THz 23,81/20,64 ATE

1) - automatic adjustment / - correzione automatica / - ajustage automatique / - reajuste automatico
2) + automatic adjustment / + correzione automatica / + ajustage automatique / + reajuste automatico
3) - air conditioning / - aria condizionata / - air conditionné / - aire acondicionado
4) + air conditioning / + aria condizionata / + air conditionné / + aire acondicionado
5) + fixed calipers / + pinze freno fisse / + étriers fixes / + pinza de fija
6) + ventilated discs / + dischi ventilati / + disques ventilés / + disco ventilado



OPEL SENATOR B / Vauxhall Royal (88-93)

	2.5		L1999999	09.90		11.0441-6003.2	250037		Dichtungssatz	ATE
	2.6		L1999999	08.90		11.0101-5407.2	260011		Hülensatz	ATE
	3.0		L1999999	09.87		11.8171-0008.1	990049		Führungsbolzen	ATE
	2.5	M1000001			09.93	24.3571-1705.5	240069		D=57, - Halter	LUC
2.6	M1000001			09.93	24.3571-1706.5	240070		D=57, - Halter	LUC	
3.0	M1000001			09.93	24.0101-3401.2	260043		Bremssattel-Zubehör	LUC	
3.0 24V				08.89	09.93					
	2.5		K1000098	09.90		24.8190-0703.2	620703	2	Warnkontakt L=860mm	
	2.6		K1000098	08.90						
	3.0		K1000098	09.87						
	2.5	K1000099	M1000000			24.8190-0709.2	620709	2	Warnkontakt L=660mm	
2.6	K1000099	M1000000								
3.0	K1000099	M1000000								
2.5	M1000001			09.93	13.0460-2815.2	602815		21368 18,3 /WE/S	LUC	
2.6	M1000001			09.93	24.8190-0716.2	620716	2	Warnkontakt L=680mm		
3.0	M1000001			09.93						
3.0 24V				08.89	09.93					
	2.5		L1999999	09.90		24.0124-0110.1	424110		280 24,0 21,0 V	
	2.6		L1999999	08.90						
	3.0		L1999999	09.87						
	2.5	M1000001			09.93	24.0128-0104.1	428104		296 28,0 25,0 V L +S +B	
2.6	M1000001			09.93						
3.0	M1000001			09.93						
3.0 24V				08.89	09.93					
	2.5			09.90	09.93	13.0460-4040.2	604040		21050 15,8	ATE
	2.6			08.90	09.93	13.0460-0347.2	610347		Belagsatz-Zubehör	ATE
	3.0			09.87	09.93	13.0460-0198.2	610198		Belagsatz-Zubehör	ATE
	3.0 24V			08.89	09.93					
	2.5			09.90	09.93	24.0110-0191.1	410191		270 10,0 8,0 +B	
	2.6			08.90	09.93					
	3.0			09.87	09.93					
	3.0 24V			08.89	09.93					
	2.5			09.90	09.93	24.5233-0200.3	330425	2	L=198	
	2.6			08.90	09.93					
	3.0			09.87	09.93					
	3.0 24V			08.89	09.93					
	2.5			09.90	09.93	03.0137-0172.2	650172		160 x 25	
	2.6			08.90	09.93	03.0137-9092.2	669092		Bremsbacken-Zubehör	
	3.0			09.87	09.93					
	3.0 24V			08.89	09.93					
	2.5			09.90	09.93	24.3727-0725.2	580725	1	L=1550/1550, + Zub	
	2.6			08.90	09.93					
	3.0			09.87	09.93					
	3.0 24V			08.89	09.93					
	2.6			08.90	09.93	24.2419-0938.3	030064		Gz 19,05	
	3.0			09.87	09.93					
	3.0 24V			08.89	09.93					
	2.6			08.90	09.93	24.2520-0904.3	040037		Nz 20,64	
	3.0			09.87	09.93					
	3.0 24V			08.89	09.93					
	2.5	K1000099		09.93		24.3728-0717.2	590717		L=1248	











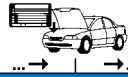

OPEL VECTRA A / Vauxhall Cavalier (89-95)

	1.4		N5299999	09.88	- ABS	24.2120-0913.3	010392		Kennzeichen: EA ¹⁾	Thz 20,64	DEL	
	1.6		N5299999	09.88	- ABS							
	1.7 D		N5299999	09.88	- ABS							
	1.7 TD		N5299999	09.88	- ABS							
	1.8		N5299999	09.88	- ABS							
	1.8 4x4			09.88	08.89	- ABS						
	1.4	P1000001			08.95	- ABS	24.2120-0702.3	010361		Kennzeichen: EB/nicht für Delco BKV ²⁾	Thz 20,64	
	1.6	P1000001			08.95	- ABS						
	1.7 D	P1000001			08.95	- ABS						
	1.7 TD	P1000001			08.95	- ABS						
2.0		NV129999	09.88	- ABS	03.2122-0264.3	010129			Thz 22,20	ATE		
2.0		N5299999	09.88	- ABS								
2.0		N1299999	09.88	- ABS								
2.0 16V		NV129999	09.88	- ABS								
2.0 16V		N5299999	09.88	- ABS								
2.0 16V		N1299999	09.88	- ABS								
2.0	P1000001			08.95	- ABS	03.2122-0264.3	010129			Thz 22,20	ATE	
2.0	P5000001			08.95	- ABS							
2.0	P7000001			08.95	- ABS							
2.0 16V	P1000001			08.95	- ABS							
2.0 16V	P5000001			08.95	- ABS							
2.0 16V	P7000001			08.95	- ABS							
1.4				09.88	08.95	+ ABS	03.2122-0282.3	010130		Thz 22,20	ATE	
1.6				09.88	08.95	+ ABS						
1.7 D				09.88	08.95	+ ABS						
1.7 TD				09.88	08.95	+ ABS						
1.8				09.88	08.95	+ ABS						
1.8 4x4				09.88	08.89	+ ABS						

¹⁾ registration number: EA / targa: EA / indice: EA / distiutivo: EA

²⁾ registration no.: EB/not for Delco BKV / targa: EB/non per Delco BKV / indice: EB/sans pour Delco BKV / distiutivo: EB/no para Delco BKV



OPEL VECTRA A / Vauxhall Cavalier (89-95)									
									
	2.0 2.0 16V			09.88 09.88	08.95 + ABS 08.95 + ABS	03.2122-0282.3	010130		Thz 22,20 ATE
	2.0 Turbo 2.5 i			03.92 02.93	08.95 08.95	03.2123-1121.3	010176		Thz 23,81 ATE
	1.4 1.4 1.6 1.6 1.7 D 1.7 D 1.7 TD 1.7 TD 1.8 1.8			09.88 09.88 09.88 09.88 09.88 09.88 09.88 09.88 09.88 09.88		11.0441-4803.2 11.0101-4802.2	250018 260007		Dichtungssatz Hülsensatz ATE ATE
	1.4 1.4 1.6 1.6 1.7 D 1.7 D 1.7 TD 1.7 TD 1.8 1.8	N1038530 N5000001 N1038530 N5000001		08.95 08.95 08.95 08.95		11.9481-9871.2 11.9481-9872.2 11.0441-4811.2 11.0101-5407.2	220681 220682 250024 260011		D=48, - Halter D=48, - Halter Dichtungssatz Hülsensatz ATE ATE ATE ATE ATE
	1.7 D 1.7 D 1.7 TD 1.7 TD 1.8 1.8 2.0 2.0 16V	R5999999 R1999999 N5000001 N1038530 R1999999 N5000001 N1038530 R1999999 S1000001 S5000001 S5000001		08.95 08.95 08.95 08.95 08.95 08.95 09.88 08.95		11.8171-0008.1 11.8116-0097.1	990049 390590	2	D=52, - Halter D=52, - Halter Dichtungssatz Hülsensatz ATE ATE ATE ATE ATE
	1.8 4x4 2.0 16V 4x4 2.0 4x4			09.88 09.88 09.88	08.89 08.95 08.95	11.0441-5402.2 11.0101-5407.2 11.8171-0008.1	250028 260011 990049	2	Dichtungssatz Hülsensatz ATE ATE ATE ATE ATE
	2.0 Turbo 2.5 i			03.92 02.93	08.95 08.95	11.3541-8085.2 24.3541-8086.5 24.3541-8085.5 11.0101-5407.2 11.8171-0008.1 11.8116-0129.1	220287 240526 240525 260011 990049 390591	2	D=54, + Halter D=54, - Halter D=54, - Halter Hülsensatz ATE ATE ATE ATE ATE
	1.4 1.4 1.6 1.6 1.7 D 1.7 D 1.7 TD 1.7 TD 1.8 1.8			09.88 09.88 09.88 09.88 09.88 09.88 09.88 09.88 09.88 09.88		13.0460-7048.2 13.0460-0127.2 24.8190-0704.2	607048 610127 620704	2	20939 15,8 /WE Belagsatz-Zubehör DEL DEL Warnkontakt L=660mm
	1.4 1.4 1.6 1.6 1.7 D 1.7 D 1.7 TD 1.7 TD 1.8 1.8 1.8 4x4 2.0 2.0 16V 2.0 16V 4x4 2.0 4x4	N1038530 N5000001 N1038530 N5000001		08.95 08.95 08.95 08.95		13.0460-7051.2 24.8190-0707.2	607051 620707	2	20547 16,5 +/-WE ATE Warnkontakt L=685mm
	1.7 D 1.7 D 1.7 TD 1.7 TD 1.8 1.8 1.8 4x4 2.0 2.0 16V 2.0 16V 4x4 2.0 4x4	S1000001 S5000001 S1000001 S5000001 S1000001 S5000001		08.95 08.95 08.95 08.95 08.95 08.95 09.88 08.95 08.95 08.95 08.95 08.95		13.0460-7052.2 24.8190-0705.2	607052 620705	2	21190 17,5 +/-WE ATE Warnkontakt L=670mm
	2.0 Turbo 2.5 i			03.92 02.93	08.95 08.95	13.0460-7080.2 24.8190-0707.2	607080 620707	2	21411 17,5 + ATE Warnkontakt L=685mm
	1.4 1.4 1.6 1.6 1.7 D 1.7 D 1.7 TD 1.7 TD 1.8 1.8			09.88 09.88 09.88 09.88 09.88 09.88 09.88 09.88 09.88 09.88		24.0113-0161.1 24.0313-0161.1	413161 513161		236 12,7 9,7 +S +B 236 12,7 9,7 +S +B PD

OPEL VECTRA A / Vauxhall Cavalier (89-95)											
	1.4	N1038530		08.95		24.0120-0115.1	420115				236 20,0 17,0 VL +S +B
	1.4	N5000001		08.95		24.0320-0115.1	520115				236 20,0 17,0 VL +S +B PD
	1.6	N1038530		08.95							
	1.6	N5000001		08.95							
	1.7 D	N5000001	R5999999			24.0120-0140.1	420140				256 20,0 17,0 VL +S +B
	1.7 D	N1038530	R1999999								
	1.7 TD	N5000001	R5999999								
	1.7 TD	N1038530	R1999999								
	1.8	N5000001	R5999999								
	1.8	N1038530	R1999999								
	1.7 D	S1000001		08.95		24.0124-0115.1	424115				256 24,0 21,0 VL +S +B
	1.7 D	S5000001		08.95		24.0324-0115.1	524115				256 24,0 21,0 VL +S +B PD
	1.7 TD	S1000001		08.95							
	1.7 TD	S5000001		08.95							
	1.8	S1000001		08.95							
	1.8	S5000001		08.95							
	1.8 4x4			09.88	08.89						
	2.0			09.88	08.95						
	2.0 16V			09.88	08.95						
	2.0 16V 4x4			09.88	08.95						
2.0 4x4			09.88	08.95							
	2.0 Turbo			03.92	08.95	24.0124-0133.1	424133				284 24,0 21,0 VL
	2.5 i			02.93	08.95						
	1.4			09.88	08.95	24.5298-0322.3	331314	2			L=322
	1.6			09.88	08.95						
	1.7 D			09.88	08.95						
	1.7 TD			09.88	08.95						
	1.8			09.88	08.95						
	1.8 4x4			09.88	08.89						
	2.0			09.88	08.95						
	2.0 16V			09.88	08.95						
	2.0 16V 4x4			09.88	08.95						
	2.0 4x4			09.88	08.95						
	2.0 Turbo			03.92	08.95						
	2.5 i			02.93	08.95						
	2.0			09.88	08.95	13.2351-0013.2	210010				D=35 ATE
	2.0 16V			09.88	08.95	13.2351-0014.2	210011				D=35 ATE
	2.5 i			02.93	08.95	24.9235-0013.5	230001				D=35 ATE
						24.9235-0014.5	230002				D=35 ATE
						13.0441-3506.2	250052				Dichtungssatz ATE
	1.8 4x4			09.88	08.89	13.0460-4043.2	604043				21140 15,0 ATE
	2.0			09.88	08.95	13.0460-0217.2	610217				Belagsatz-Zubehör ATE
	2.0 16V			09.88	08.95						
	2.0 16V 4x4			09.88	08.95						
	2.0 4x4			09.88	08.95						
	2.0 Turbo			03.92	08.95						
	2.5 i			02.93	08.95						
	1.8 4x4			09.88	08.89	24.0110-0205.1	410205				270 9,9 8,0 +B
	2.0 16V			09.88							
	2.0 16V	NV299999		09.88							
	2.0 16V	N5299999		09.88							
	2.0 16V	N1299999		09.88							
	2.0 16V 4x4			09.88	08.95						
	2.0 4x4			09.88	08.95						
	2.0			09.88		24.0110-0144.1	410144				261 9,9 8,0
	2.0			09.88							
	2.0	NV299999		09.88							
	2.0	N5299999		09.88							
	2.0	N1299999		09.88							
	2.0	P1000001		08.95		24.0110-0204.1	410204				260 10,0 8,0 +B
	2.0 16V	P1000001		08.95							
	2.0 Turbo			03.92	08.95	24.0110-0253.1	410253				270 10,0 8,0
	2.5 i			02.93	08.95	24.0110-0249.1	410249				260 10,0 8,0
	1.4			09.88		24.5233-0200.3	330425	2			L=198
	1.6			09.88							
	1.7 D			09.88							
	1.7 TD			09.88							
	1.8			09.88							
	1.8 4x4			09.88	08.89						
	2.0			09.88							
	2.0 16V			09.88							
	2.0 16V 4x4			09.88							
	2.0 4x4			09.88							
	2.0 Turbo			03.92							
	2.5 i			02.93							
	1.4			08.95		24.5117-0195.3	330565	2			L=198
	1.6			08.95							
	1.7 D			08.95							
	1.7 TD			08.95							
	1.8			08.95							
	2.0			08.95							
	2.0 16V			08.95							
2.0 16V 4x4			08.95								
2.0 4x4			08.95								
2.0 Turbo			08.95								
2.5 i			08.95								

































OPEL VECTRA A / Vauxhall Cavalier (89-95)									
	1.4 1.6 1.7 D 1.7 TD 1.8			09.88 09.88 09.88 09.88 09.88	08.95 08.95 08.95 08.95 08.95	24.3219-1767.3 24.3219-1715.3	020552 020122	+ GG ¹⁾ + ALU ²⁾	Rz 19,05 Rz 19,05 (ALU)
	1.4 1.6 1.7 D 1.7 TD 1.8		N5999999 N5999999 N5999999 N5999999 N5999999	09.88 09.88 09.88 09.88 09.88		03.0137-0166.2 03.0137-9060.2	650166 669060		200 x 46 HEB Bremsbacken-Zubehör LUC
	1.4 1.6 1.7 D 1.7 TD 1.8	P1000001 P1000001 P1000001 P1000001 P1000001			08.95 08.95 08.95 08.95 08.95	03.0137-0267.2 03.0137-9167.2	650267 669167		200 x 46 HEB Bremsbacken-Zubehör
	1.4 1.6 1.7 D 1.7 TD 1.8			09.88 09.88 09.88 09.88 09.88	08.95 08.95 08.95 08.95 08.95	24.0220-0001.2	480013		200/201 x 53,5
	1.4 1.6 1.7 D 1.7 TD 1.8	P1000001 P1000001 P1000001 P1000001 P1000001			08.95 08.95 08.95 08.95 08.95	03.0420-4019.3 03.0520-4019.3	684019 694019		19,05/200x46 Kit DEL 19,05/200x46 TopKit DEL
	1.8 4x4 2.0 2.0 16V 2.0 Turbo 2.5 i		NV299999 NV299999 NV299999 NV299999	09.88 09.88 09.88 03.92 02.93	08.89 08.89 08.89 08.89 08.89	03.0137-0172.2 03.0137-9092.2	650172 669092		160 x 25 Bremsbacken-Zubehör
	2.0 2.0 16V 2.0 Turbo 2.5 i	P1000001 P1000001 P1000001 P1000001			08.95 08.95 08.95 08.95	03.0137-0172.2 03.0137-9242.2	650172 669242		160 x 25 Bremsbacken-Zubehör
	1.4 1.6 1.7 D 1.7 TD 1.8			09.88 09.88 09.88 09.88 09.88	08.95 08.95 08.95 08.95 08.95	24.3727-0734.2 24.3727-0733.2	580734 580733	<input type="checkbox"/> <input type="checkbox"/>	L=750, + Zub L=2120, + Zub
	1.8 4x4 2.0 16V 2.0 4x4 2.0 Turbo		NV299999	09.88 09.88 09.88 03.92	08.89 08.89 08.95 08.95	24.3727-0736.2	580736	1	L=1365/1498, + Zub
	2.0 2.0 16V 2.5 i	P1000001		09.88 08.95 02.93	08.95 08.95 08.95	24.3727-0739.2 24.3727-0740.2	580739 580740	<input type="checkbox"/> <input type="checkbox"/>	L=665, + Zub L=2022, + Zub
	1.4 1.6 1.7 D 1.7 TD 1.8	P1000001 P1000001 P1000001 P1000001 P1000001			08.95 08.95 08.95 08.95 08.95	03.0101-0027.2	320022		BRES 3/45 ATE
	2.5 i			02.93	08.95	03.0101-0025.2	320014		BRES 3/35 ATE
	1.4 1.6 1.7 D 1.7 TD	◀ ◀ ◀ ◀		09.88 09.88 09.88 09.88	08.95 08.95 08.95 08.95	24.3728-0712.2	590712		L=835
	1.8 2.0 2.0 16V 2.5 i	◀ ◀ ◀ ◀		09.88 09.88 09.88 02.93	08.95 08.95 08.95 08.95	24.3728-0715.2	590715		L=835
DIV	1.8 4x4 2.0 4x4 2.0 Turbo 4x4			09.88 09.88 03.92	08.89 08.95 08.95	10.0515-0515.3	340024	+ Verteilergetriebe ³⁾	Hydraulikspeicher ATE

PEUGEOT J7 (65-80)

	1.6 1.8 2.1 D 2.3 D			09.73 09.73 09.73 03.77	09.80 09.80 10.78 09.80	24.0114-0107.1	414107		280 14,0 12,6
	1.6 1.8 2.1 D 2.3 D			09.73 09.73 09.73 03.77	09.80 09.80 10.78 09.80	24.5122-0460.3	330493	4	L=460
	1.6 1.8 2.1 D 2.3 D	◀ ◀ ◀ ◀		09.73 09.73 09.73 03.77	09.80 09.80 10.78 09.80	24.3225-0903.3	020327		Rz 25,40
	1.6 1.8 2.1 D 2.3 D	◀ ◀ ◀ ◀		09.75 09.75 09.75 03.77	09.80 09.80 10.78 09.80	24.2419-1503.3	030079		Gz 19,05

1) + cast iron / + ghisa / + fonte grise / + fundición de gris
 2) + aluminium / + alluminio / + aluminium / + aluminio
 3) + distribution transmission / + differenziale centrale / + transmission 4x4 / + engranaje de distribución
 4) - bus / - autobus / - autobus/car / - autobús

								
PEUGEOT J5 (81-94)								
	1.8 1.9 D 2.0 2.0 2.5 D 2.5 TD	51 55 58 54 70		11.81 10.87 11.81 11.81 11.81 10.87	06.94 06.94 06.94 06.94 06.94 06.94	24.2122-0801.3	010373	1 Anschluß verschließen ¹⁾ Thz 22,20
	1.8 1.9 D 2.0 2.0 2.5 D 2.5 TD	51 55 58 54 70	0154462 0154462 0154462 0154462	11.81 10.87 06.94 06.94 06.94 10.87	06.94 06.94 06.94 06.94 06.94 06.94	24.0101-3801.2	260045	Bremssattel-Zubehör LUC
	1.8 1.9 D 2.0 2.0 2.5 D 2.5 TD	51 55 58 54 70		11.81 10.87 11.81 11.81 11.81 10.87	06.94 06.94 06.94 06.94 06.94 06.94	13.0460-2901.2	602901	20741 19,0 +/WK/S LUC
	2.5 D 2.5 TD	54 70		11.81 10.87	06.94 06.94	13.0460-2902.2	602902	21205 19,0 +/WK/S LUC
	1.8 2.0 2.0 2.5 D	51 55 58 54	0154461 0154461 0154461 0154461	11.81 11.81 11.81 11.81	06.94 06.94 06.94 06.94	24.0113-0168.1	413168	256 13,0 11,0
	1.8 1.9 D 2.0 2.0 2.5 D 2.5 TD	51 55 58 54 70	0154462 0154462 0154462 0154462	11.81 10.87 06.94 06.94 06.94 10.87	06.94 06.94 06.94 06.94 06.94 06.94	24.0116-0105.1	416105	256 16,1 13,5 +B
	2.5 D 2.5 TD	54 70		11.81 10.87	06.94 06.94	24.0116-0106.1	416106	290 16,0 14,8
	1.8 2.0 2.0 2.5 D	51 55 58 54		11.81 11.81 11.81 11.81	08.84 08.84 08.84 08.84	24.5112-0362.3	330512	4 L=362
	1.8 1.9 D 2.0 2.0 2.5 D 2.5 TD	51 55 58 54 70		09.84 10.87 09.84 09.84 09.84 10.87	06.94 06.94 06.94 06.94 06.94 06.94	24.5112-0435.3 24.5112-0436.3	330524 330574	2 2 L=435, + Clip L=435, - Clip
	1.8 2.0 2.0 2.5 TD	51 55 58 70		11.81 11.81 11.81 10.87	06.94 06.94 06.94 06.94	24.5112-0260.3	330577	1 <input type="checkbox"/> L=260
	1.9 D 2.5 D	54		10.87 11.81	06.94 06.94	24.5112-0285.3	330604	1 <input type="checkbox"/> L=285
	2.5 D 2.5 TD	54 70		11.81 10.87	06.94 06.94	24.5112-0285.3	330604	1 <input type="checkbox"/> L=285
	1.9 D 2.0 2.0 2.5 D 2.5 TD	55 58 54 70	0077160 0077160 0077160	10.87 06.94 06.94 06.94 10.87	06.94 06.94 06.94 06.94 06.94	24.3225-1101.3	020294	Rz 25,40 LUC
	2.5 D 2.5 TD	54 70	0077160	10.87	06.94 06.94	24.3226-1101.3	020296	Rz 26,99
	1.8 1.9 D 2.0 2.0 2.5 D 2.5 TD	51 55 58 54 70		11.81 10.87 11.81 11.81 11.81 10.87	06.94 06.94 06.94 06.94 06.94 06.94	03.0137-0330.2 03.0137-9216.2	650330 669216	254 x 57 HEB LUC Bremsbacken-Zubehör LUC
	2.5 D 2.5 TD	54 70		11.81 10.87	06.94 06.94	03.0137-0269.2 03.0137-9169.2	650269 669169	254 x 57 HEB Bremsbacken-Zubehör
	1.8 1.9 D 2.0 2.0 2.5 D 2.5 TD	51 55 58 54 70		11.81 10.87 11.81 11.81 11.81 10.87	06.94 06.94 06.94 06.94 06.94 06.94	24.0225-4002.1	480048	254/255,6 x 63,5
	1.9 D 2.0 2.0 2.5 D 2.5 TD	55 58 54 70	0077160 0077160 0077160	10.87 06.94 06.94 06.94 10.87	06.94 06.94 06.94 06.94 06.94	03.0520-0125.3	690125	25,40/254x57 TopKit LUC
	1.8 1.9 D 2.0 2.5 D 2.5 TD	51 55 54 70		11.81 10.87 11.81 11.81 10.87	07.90 07.90 07.90 07.90 07.90	24.3727-0527.2	580527	1 <input type="checkbox"/> L=2566

¹⁾ 1 close (plug) connection / tappare 1 raccordo / fermer 1 raccord / cerrar 1 conexión

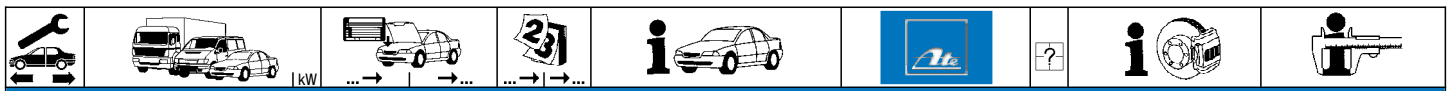

PEUGEOT J5 (81-94)

	1.8 2.0 2.5 D	51 58 54	0077159 0077159	11.81 11.81 11.81	07.90	24.6513-1701.3	320160		BRL 3/10 (4)
	1.8 1.9 D 2.0 2.5 D 2.5 TD	51 58 54 70		11.81 10.87 11.81 11.81 10.87	07.90 07.90 07.90 07.90	24.3728-0515.2	590515		L=1200

PEUGEOT J9 (80-92)

	1.6 2.0 2.1 D 2.3 D 2.5 D			01.80 01.80 01.80 01.80 10.82	12.92 12.92 12.92 09.82 12.92	24.0114-0107.1	414107		280 14,0 12,6
	1.6 2.0 2.1 D 2.3 D 2.5 D			01.80 01.80 01.80 01.80 10.82	12.92 12.92 12.92 09.82 12.92	24.5122-0460.3	330493	4	L=460
	1.6 2.0 2.1 D 2.3 D 2.5 D			01.80 01.80 01.80 01.80 10.82	10.85 10.85 10.85 09.82 10.85	24.3225-0903.3	020327		Rz 25,40
	1.6 2.0 2.1 D 2.3 D 2.5 D			01.80 01.80 01.80 01.80 10.82	12.92 12.92 12.92 09.82 12.92	24.2419-1503.3	030079		Gz 19,05

PEUGEOT 104 (72-87)

	1.1 GL6/SL	42	7.236.001	7.241.000		24.2117-1501.3	010398		THz 17,46
	1.0		5.937.571		09.83	24.2119-1503.3	010404		THz 19,05
	1.0		7.252.260		09.83				
	1.1	37	5.937.571		09.87				
	1.1	37	7.252.260		09.87				
	1.1	42	5.937.571		09.84				
	1.1	42	7.252.260		09.84				
	1.2		5.937.571		09.83				
	1.2		7.252.260		09.83				
	1.4		5.937.571		09.83				
	1.4		7.252.260		09.83				
	1.0				10.72	13.0460-3928.2	603928		20140 14,0 +/WE BDX
	1.1	37			10.78				
	1.1	48			09.73				
	1.1 GR/SR	42			09.79				
	1.2				09.80				
	1.4				09.83				
	1.1	37			10.83	13.0460-3928.2	603928		20140 14,0 +/WE BDX
	1.1 GR/SR	42			10.83				
	1.4				09.85				
	1.0		5.567.080		09.83	24.3222-1102.3	020257		Rz 22,20 BDX
	1.0		7.101.910		09.83				
	1.1	37	5.567.080		09.87				
	1.1	37	7.101.910		09.87				
	1.1 GR/SR	42	5.567.080		09.84				
	1.1 GR/SR	42	7.101.910		09.84				
	1.2		5.567.080		09.83				
	1.2		7.101.910		09.83				
	1.4		5.567.080		09.85				
	1.4		7.101.910		09.85				
	1.1 GL6/SL	42	7.236.001	7.241.000		24.3220-1105.3	020216		Rz 20,64 BDX
	1.0		7.000.001	7.101.099	10.72	03.0137-9032.2	669032		Bremsbacken-Zubehör BDX
	1.0			5.670.079					
	1.1	37	7.000.001	7.101.099					
	1.1	37		5.670.079	10.78				
	1.1	48	7.000.001	7.101.099					
	1.1	48		5.670.079	09.73				
	1.1 GR/SR	42	7.000.001	7.101.099					
	1.1 GR/SR	42		5.670.079	09.79				
	1.2		7.000.001	7.101.099					
	1.2			5.670.079	09.80				
	1.4		7.000.001	7.101.099					
	1.4			5.670.079	09.80				
	1.0		5.567.080		09.83	03.0137-9032.2	669032		Bremsbacken-Zubehör BDX
	1.0		7.101.910		09.83				
	1.1		5.567.080		09.87				
	1.1		7.101.910		09.87				
	1.1 GL6/SL	42	7.236.001	7.241.000	09.84				
	1.1 GR/SR	42	7.101.910		09.84				
	1.2		7.101.910		09.83				
	1.4		7.101.910		09.85				



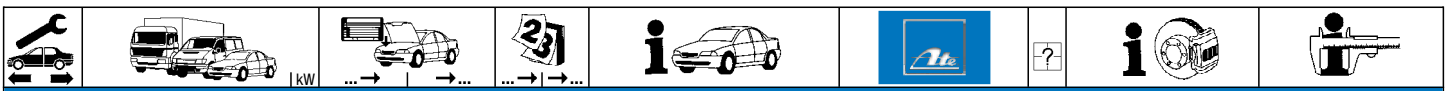

PEUGEOT 104 (72-87)





















	1.0		5.315.633		09.83		03.6043-0201.3	320026			BR S/3 (3)	ATE
	1.0		7.000.001		09.83							
	1.1		37 5.315.633		09.87							
	1.1		37 7.000.001		09.87							
	1.1		48 5.315.633		09.79							
	1.1		48 7.000.001		09.79							
	1.1 GL6/SL		42 7.236.001	7.241.000								
	1.1 GR/SR		42 5.315.633		09.84							
	1.1 GR/SR		42 7.000.001		09.84							
	1.2		5.315.633		09.83							
	1.2		7.000.001		09.83							
	1.4		5.315.633		09.85							
	1.4		7.000.001		09.85							

PEUGEOT 106 (91-96)

	1.0				08.91	04.96 - ABS/ + 3 türig ¹⁾	03.2119-3389.3	010057			Thz 19,05	ATE
	1.1	44			08.91	04.96 - ABS/ + 3 türig ¹⁾						
	1.4	51			08.91	03.96 - ABS						
	1.4	55			08.91	04.96 - ABS						
	1.4 D	37			08.92	04.96 - ABS						
	1.5 D				06.94	04.96 - ABS						
	1.6	65			06.93	04.96 - ABS						
	1.0				08.91	04.96 - ABS/ + 5 türig ²⁾	03.2120-2031.3	010106			Thz 20,64	ATE
	1.1	44			08.91	04.96 - ABS/ + 5 türig ²⁾						
	1.3 Rallye	72			10.93	04.96 - ABS						
	1.4	69			08.91	04.96 - ABS						
	1.4	72			08.91	03.96 - ABS						
	1.6	76			01.94	04.96 - ABS						
	1.0				08.91	04.96 - ABS	11.0441-4501.2	250015			Dichtungssatz	ATE
	1.1	44			08.91	04.96 - ABS						
	1.3 Rallye	72	S 51132347			04.96	11.3481-9833.2	220561			D=48, - Halter	ATE
	1.4	51	S 51132347			03.96 + ABS	11.3481-9834.2	220562			D=48, - Halter	ATE
	1.4	55	S 51132347			04.96 + ABS	24.3481-9833.5	240479			D=48, - Halter	ATE
	1.4 D	37	S 51132347			04.96 + ABS	24.3481-9834.5	240480			D=48, - Halter	ATE
	1.5 D		S 51132347			04.96 + ABS	11.0441-4811.2	250024			Dichtungssatz	ATE
	1.6	65	S 51132347			04.96 + ABS	11.0101-5407.2	260011			Hülssensatz	ATE
	1.6	76	S 51132347			04.96	11.8171-0008.1	990049			Führungsbolzen	ATE
	1.6	76	S 51132347			04.96	11.8116-0129.1	390591	2		Haltefeder	ATE
	1.0			S 50994342	08.91	- ABS	13.0460-4042.2	604042		für 3-Loch-Felge ³⁾	21191 16,8 +/WK	ATE
	1.1	44		S 50994342	08.91	- ABS	13.0460-3943.2	603943		für 4-Loch-Felge ⁴⁾	20906 18,0 +/WK	BDX
							13.0460-0424.2	610424		für 3-Loch-Felge ³⁾	Belagsatz-Zubehör	ATE
							13.0460-0403.2	610403		für 4-Loch-Felge ⁴⁾	Belagsatz-Zubehör	BDX
	1.0		S 50994343			04.96 - ABS	13.0460-4066.2	604066		für 3-Loch-Felge ³⁾	21857 17,7	ATE
	1.1	44	S 50994343			04.96 - ABS	13.0460-3962.2	603962		für 4-Loch-Felge ⁴⁾	20905 18,0 +/WE	BDX
							13.0460-0424.2	610424		für 3-Loch-Felge ³⁾	Belagsatz-Zubehör	ATE
							13.0460-0403.2	610403		für 4-Loch-Felge ⁴⁾	Belagsatz-Zubehör	BDX
	1.0				08.91	04.96 + ABS	13.0460-3943.2	603943			20906 18,0 +/WK	BDX
	1.1	44			08.91	04.96 + ABS	13.0460-0406.2	610406			Belagsatz-Zubehör	BDX
	1.4	51		S 50994342	08.91	- ABS	13.0460-3943.2	603943			20906 18,0 +/WK	BDX
	1.4	55		S 50994342	08.91	- ABS	13.0460-0403.2	610403			Belagsatz-Zubehör	BDX
	1.4 D	37		S 50994342	08.92	- ABS						
	1.5 D			S 50994342	06.94	- ABS						
	1.6	65		S 50994342	06.93	- ABS						
	1.4	51	S 50994343			03.96 - ABS	13.0460-3962.2	603962			20905 18,0 +/WE	BDX
	1.4	55	S 50994343			04.96 - ABS	13.0460-0403.2	610403			Belagsatz-Zubehör	BDX
	1.4 D	37	S 50994343			04.96 - ABS						
	1.5 D		S 50994343			04.96 - ABS						
	1.6	65	S 50994343			04.96 - ABS						
	1.6	76	S 50994343			04.96 - ABS						
	1.3 Rallye	72	S 51132346		10.93		13.0460-3943.2	603943			20906 18,0 +/WK	BDX
	1.4	51	S 51132346		08.91	+ ABS	13.0460-0406.2	610406			Belagsatz-Zubehör	BDX
	1.4	55	S 51132346		08.91	+ ABS						
	1.4	69	S 51132346		08.91	04.96						
	1.4	72	S 51132346		08.91	03.96						
	1.4 D	37	S 51132346		08.92	+ ABS						
	1.5 D		S 51132346		06.94	+ ABS						
	1.6	65	S 51132346		06.93	+ ABS						
	1.6	76	S 51132346		01.94							
	1.3 Rallye	72	S 51132347			04.96	13.0460-7088.2	607088			21827 17,3 +	ATE
	1.4	51	S 51132347			03.96 + ABS						
	1.4	55	S 51132347			04.96 + ABS						
	1.4	69	S 51132347			04.96 + ABS						
	1.4 D	37	S 51132347			04.96 + ABS						
	1.5 D		S 51132347			04.96 + ABS						
	1.6	65	S 51132347			04.96 + ABS						
	1.6	76	S 51132347			04.96						
	1.0				08.91	04.96 - ABS	24.0108-0107.1	408107		für 3-Loch-Felge ³⁾	238 8,0 6,0 +S +B	
	1.1	44			08.91	04.96 - ABS	24.0110-0187.1	410187		für 4-Loch-Felge ⁴⁾	247 10,0 9,0 +S +B	
	1.0				08.91	04.96 + ABS	24.0120-0132.1	420132			247 20,4 18,5 V +S +B	
	1.1	44			08.91	04.96 + ABS	24.0320-0132.1	520132			247 20,4 18,5 V +S +B PD	
	1.4	51			08.91	03.96 - ABS	24.0110-0187.1	410187			247 10,0 9,0 +S +B	
	1.4	55			08.91	04.96 - ABS						
	1.4 D	37			08.92	04.96 - ABS						
	1.5 D				06.94	04.96 - ABS						
	1.6	65			06.93	04.96 - ABS						
	1.3 Rallye	72			10.93	04.96	24.0120-0132.1	420132			247 20,4 18,5 V +S +B	
	1.4	51			08.91	03.96 + ABS	24.0320-0132.1	520132			247 20,4 18,5 V +S +B PD	
	1.4	55			08.91	04.96 + ABS						
	1.4	69			08.91	04.96 + ABS						

1) - ABS/ + 3 door / - ABS/ + 3 porte / - ABS/ + 3 portes / - ABS/ + 3 puertas
 2) - ABS/ + 5 door / - ABS/ + 5 porte / - ABS/ + 5 portes / - ABS/ + 5 puertas
 3) for 3 bore wheel rim / per cerchione a 3 fori / pour jante à 3 trous / para Liantas de 3 taladros
 4) for 4 bore wheel rim / per cerchione a 4 fori / pour jante à 4 trous / para Liantas de 4 taladros



								
PEUGEOT 106 (91-96)								
	1.4	69		08.91 04.96	24.0120-0132.1	420132		247 20,4 18,5 V +S +B
	1.4	72		08.91 03.96	24.0320-0132.1	520132		247 20,4 18,5 V +S +B PD
	1.4 D	37		08.92 04.96 + ABS				
	1.5 D			06.94 04.96 + ABS				
	1.6	65		07.94 04.96 + ABS				
	1.6	76		07.94 04.96				
	1.0			08.91 04.96 - ABS/ + 3 türig ¹⁾	24.5111-0290.3	330108	2	L=290
	1.1	44		08.91 04.96 - ABS/ + 3 türig ¹⁾				
	1.0			08.91 04.96 - ABS/ + 5 türig ²⁾	24.5111-0330.3	330160	2	L=330
	1.1	44		08.91 04.96 - ABS/ + 5 türig ²⁾				
	1.0			08.91 03.95 + ABS	24.5111-0290.3	330108	2	L=290
	1.1	44		08.91 03.95 + ABS				
	1.0			04.95 04.96 + ABS	24.5111-0301.3	330499	2	L=300
	1.1	44		04.95 04.96 + ABS				
	1.3 Rallye	72		10.93 03.95	24.5111-0290.3	330108	2	L=290
	1.4	51		08.91 03.96 - ABS				
	1.4	55		08.91 04.96 - ABS				
	1.4	69		08.91 04.96 - ABS				
	1.4	72		08.91 03.96 - ABS				
	1.4 D	37		08.92 04.96 - ABS				
	1.5 D			06.94 04.96 - ABS				
	1.6	65		06.93 04.96 - ABS				
	1.6	76		01.94 03.95				
	1.4	51		08.91 03.95 + ABS	24.5111-0290.3	330108	2	L=290
	1.4	55		08.91 03.95 + ABS				
	1.4	69		08.91 03.95 + ABS				
	1.4	72		08.91 03.95 + ABS				
	1.4 D	37		08.92 03.95 + ABS				
	1.5 D			06.94 03.95 + ABS				
	1.6	65		01.94 03.95 + ABS				
	1.3 Rallye	72		04.95 04.96	24.5111-0301.3	330499	2	L=300
	1.4	51		04.95 03.96 + ABS				
	1.4	55		04.95 04.96 + ABS				
	1.4	69		04.95 04.96 + ABS				
	1.4	72		04.95 03.96 + ABS				
	1.4 D	37		04.95 04.96 + ABS				
	1.5 D			04.95 04.96 + ABS				
	1.6	65		04.95 04.96 + ABS				
	1.6	76		04.95 04.96				
	1.0			08.91 04.96 - verstärktes Fahrwerk ³⁾	24.5229-0199.3	330534	2	L=200
	1.1	44		08.91 04.96 - verstärktes Fahrwerk ³⁾				
	1.3 Rallye	72		10.93 04.96 - verstärktes Fahrwerk ³⁾				
	1.4	51		08.91 03.96 - verstärktes Fahrwerk ³⁾				
	1.4	55		08.91 04.96 - verstärktes Fahrwerk ³⁾				
	1.4	69		08.91 04.96 - verstärktes Fahrwerk ³⁾				
	1.4	72		08.91 03.96 - verstärktes Fahrwerk ³⁾				
	1.4 D	37		08.92 04.96 - verstärktes Fahrwerk ³⁾				
	1.5 D			06.94 04.96 - verstärktes Fahrwerk ³⁾				
	1.6	65		06.93 04.96 - verstärktes Fahrwerk ³⁾				
	1.6	76		01.94 04.96 - verstärktes Fahrwerk ³⁾				
	1.0			08.91 04.96 + verstärktes Fahrwerk ⁴⁾	24.5229-0199.3	330534		L=200
	1.1	44		08.91 04.96 + verstärktes Fahrwerk ⁴⁾	24.5229-0211.3	330573		L=210
	1.3 Rallye	72		10.93 04.96 + verstärktes Fahrwerk ⁴⁾				
	1.4	51		08.91 03.96 + verstärktes Fahrwerk ⁴⁾				
	1.4	55		08.91 04.96 + verstärktes Fahrwerk ⁴⁾				
	1.4	69		08.91 04.96 + verstärktes Fahrwerk ⁴⁾				
	1.4	72		08.91 03.96 + verstärktes Fahrwerk ⁴⁾				
	1.4 D	37		08.92 04.96 + verstärktes Fahrwerk ⁴⁾				
	1.5 D			06.94 04.96 + verstärktes Fahrwerk ⁴⁾				
	1.6	65		06.93 04.96 + verstärktes Fahrwerk ⁴⁾				
	1.6	76		01.94 04.96 + verstärktes Fahrwerk ⁴⁾				
	1.0			08.91 04.96 - ABS/ + 3 türig ¹⁾	24.3219-1609.3	020319	 + 4-Loch-Felge ⁵⁾	RzR 19,05
	1.1	44		08.91 04.96 - ABS/ + 3 türig ¹⁾	24.3219-1610.3	020320	 + 4-Loch-Felge ⁵⁾	RzR 19,05
	1.0			08.91 04.96 - ABS/ + 5 türig ²⁾	24.3219-1603.3	020200	 + 3-Loch-Felge ⁶⁾	RzR 19,05
	1.1	44		08.91 04.96 - ABS/ + 5 türig ²⁾	24.3219-1604.3	020201	 + 3-Loch-Felge ⁶⁾	RzR 19,05
	1.0			08.91 04.96 + ABS	24.3219-1112.3	020311		Rz 19,05
	1.1	44		08.91 04.96 + ABS				BDX
	1.3 Rallye	72		10.93 04.96 - ABS	24.3219-1609.3	020319		RzR 19,05
	1.4	51		08.91 03.96 - ABS	24.3219-1610.3	020320		RzR 19,05
	1.4	55		08.91 04.96 - ABS				
	1.4	69		08.91 04.96 - ABS				
	1.4	72		08.91 03.96 - ABS				
	1.4 D	37		08.92 04.96 - ABS				
	1.5 D			06.94 04.96 - ABS				
	1.6	65		06.93 04.96 - ABS				
	1.6	76		01.94 04.96 - ABS				
	1.3 Rallye	72		10.93 04.96 + ABS	24.3219-1112.3	020311		Rz 19,05
	1.4	51		08.91 03.96 + ABS				BDX
	1.4	55		08.91 04.96 + ABS				
	1.4	69		08.91 04.96 + ABS				
	1.4	72		08.91 03.96 + ABS				
	1.4 D	37		08.92 04.96 + ABS				
	1.5 D			06.94 04.96 + ABS				
	1.6	65		06.93 04.96 + ABS				
	1.6	76		01.94 04.96 + ABS				

¹⁾ - ABS/ + 3 door / - ABS/ + 3 porte / - ABS/ + 3 portes / - ABS/ + 3 puertas
²⁾ - ABS/ + 5 door / - ABS/ + 5 porte / - ABS/ + 5 portes / - ABS/ + 5 puertas
³⁾ - reinforced suspension / - sospensione rinforzata / - châssis renforcé / - suspensión reforzada
⁴⁾ + reinforced suspension / + sospensione rinforzata / + châssis renforcé / + suspensión reforzada
⁵⁾ + 4 bore wheel rim / + cerchione a 4 fori / + jante à 4 trous / + Llantas de 4 taladros
⁶⁾ + 3 bore wheel rim / + cerchione a 3 fori / + jante à 3 trous / + Llantas de 3 taladros

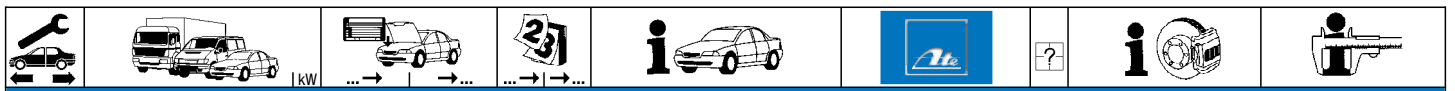

PEUGEOT 106 (91-96)

	1.0			08.91	04.96	- ABS/ + 3 türig ¹⁾	03.0137-0196.2	650196		+ 4-Loch-Felge ²⁾	180 x 32 AUT	BDX
	1.1	44		08.91	04.96	- ABS/ + 3 türig ¹⁾	03.0137-9055.2	669055		+ 4-Loch-Felge ²⁾	Bremsbacken-Zubehör	BDX
	1.0			08.91	04.96	- ABS/ + 5 türig ³⁾	03.0137-0195.2	650195		+ 3-Loch-Felge ⁴⁾	164 x 32 AUT	
	1.1	44		08.91	04.96	- ABS/ + 5 türig ³⁾	03.0137-9079.2	669079		+ 3-Loch-Felge ⁴⁾	Bremsbacken-Zubehör	
	1.0			08.91	04.96	+ ABS	03.0137-0196.2	650196			180 x 32 AUT	BDX
	1.1	44		08.91	04.96	+ ABS	03.0137-9055.2	669055			Bremsbacken-Zubehör	BDX
	1.3 Rallye	72		10.93	04.96		03.0137-0196.2	650196			180 x 32 AUT	BDX
	1.4	51		08.91	03.96		03.0137-9055.2	669055			Bremsbacken-Zubehör	BDX
	1.4	55		08.91	04.96							
	1.4	69		08.91	04.96							
1.4	72		08.91	03.96								
1.4 D	37		08.92	04.96								
1.5 D			06.94	04.96								
1.6	65		06.93	04.96								
1.6	76		01.94	04.96								
	1.0			08.91	04.96	- ABS/ + 3 türig ¹⁾	24.0218-0017.1	480060		+ 4-Loch-Felge ²⁾	180/181 x 40,5 - Lager	
	1.1	44		08.91	04.96	- ABS/ + 3 türig ¹⁾						
	1.0			08.91	04.96	- ABS/ + 5 türig ³⁾	24.0216-5001.1	480001		für 3-Loch-Felge/- Sensorring ⁵⁾	165/166 x 38,5 - Lager	
	1.1	44		08.91	04.96	- ABS/ + 5 türig ³⁾	24.0216-5701.2	480212		für 3-Loch-Felge/- Sensorring ⁵⁾	165/166 x 38,5 + Lager	
	1.0			08.91	04.96	+ ABS	24.0218-0017.1	480060			180/181 x 40,5 - Lager	
	1.1	44		08.91	04.96	+ ABS						
	1.4	51		08.91	03.96		24.0218-0017.1	480060			180/181 x 40,5 - Lager	
	1.4	55		08.91	04.96							
	1.4 D	37		08.92	04.96							
	1.5 D			06.94	04.96	- ABS						
1.6	65		06.93	04.96	- ABS							
1.6	76		01.94	04.96	- ABS							
1.3 Rallye	72		10.93	04.96		24.0218-0020.1	480074			180/181 x 46 - Lager		
1.4	69		08.91	04.96		24.0218-0720.2	480205			180/181 x 46 + Lager		
1.4	72		08.91	03.96								
1.5 D			06.94	04.96	+ ABS							
1.6	65		06.93	04.96	+ ABS							
1.6	76		01.94	04.96								
	1.0			08.91	04.96	- ABS/ + 3 türig ¹⁾	03.0420-1619.3	681619		+ 4-Loch-Felge ²⁾	19,05/180x32 Kit	BDX
	1.1	44		08.91	04.96	- ABS/ + 3 türig ¹⁾	03.0520-1619.3	691619		+ 4-Loch-Felge ²⁾	19,05/180x32 TopKit	BDX
	1.0			08.91	04.96	- ABS/ + 5 türig ³⁾	03.0420-0519.3	680519		+ 3-Loch-Felge ⁴⁾	19,05/164x32 Kit	BDX
	1.1	44		08.91	04.96	- ABS/ + 5 türig ³⁾	03.0520-0519.3	690519		+ 3-Loch-Felge ⁴⁾	19,05/164x32 TopKit	BDX
	1.3 Rallye	72		10.93	04.96	- ABS	03.0420-1619.3	681619			19,05/180x32 Kit	BDX
	1.4	51		08.91	03.96	- ABS	03.0520-1619.3	691619			19,05/180x32 TopKit	BDX
	1.4	55		08.91	04.96	- ABS						
	1.4	69		08.91	04.96	- ABS						
	1.4	72		08.91	03.96	- ABS						
	1.4 D	37		08.92	04.96	- ABS						
1.5 D			06.94	04.96	- ABS							
1.6	65		06.93	04.96	- ABS							
1.6	76		01.94	04.96	- ABS							
	1.0		S 51224674	08.91			24.3727-0807.2	580807	2 ↓		L=1292	
	1.1	44	S 51224674	08.91								
	1.3 Rallye	72	S 51224674	10.93								
	1.4	51	S 51224674	08.91								
	1.4	55	S 51224674	08.91								
	1.4	69	S 51224674	08.91								
	1.4	72	S 51224674	08.91								
	1.4 D	37	S 51224674	08.92								
	1.5 D		S 51224674	06.94								
	1.6	65	S 51224674	06.93								
1.6	76	S 51224674	01.94									
	1.0		S 51224675		04.96		24.3727-0816.2	580816	2 ↓		L=1442	
	1.1	44	S 51224675		04.96							
	1.3 Rallye	72	S 51224675		04.96							
	1.4	51	S 51224675		03.96							
	1.4	55	S 51224675		04.96							
	1.4	69	S 51224675		04.96							
	1.4	72	S 51224675		03.96							
	1.4 D	37	S 51224675		04.96							
	1.5 D		S 51224675		04.96							
	1.6	65	S 51224675		04.96							
1.6	76	S 51224675		04.96								
	1.0			08.91	04.96	- Servolenkung ⁶⁾	24.3728-0812.2	590812			L=658	
	1.1	44		08.91	04.96	- Servolenkung ⁶⁾						
	1.3 Rallye	72		10.93	04.96	- Servolenkung ⁶⁾						
	1.0			08.91	04.96	+ Servolenkung ⁷⁾	24.3728-0814.2	590814			L=678	
	1.1	44		08.91	04.96	+ Servolenkung ⁷⁾						
	1.3 Rallye	72		10.93	04.96	+ Servolenkung ⁷⁾						
	1.4	51		08.91	03.96	- Servolenkung ⁶⁾	24.3728-0819.2	590819			L=1276	
	1.4	55		08.91	04.96	- Servolenkung ⁶⁾						
	1.4	69		08.91	04.96	- Servolenkung ⁶⁾						
	1.4	72		08.91	03.96	- Servolenkung ⁶⁾						
1.4 D	37		08.92	04.96	- Servolenkung ⁶⁾							
1.5 D			06.94	04.96	- Servolenkung ⁶⁾							
1.6	65		06.93	04.96	- Servolenkung/ - Klimaanlage ⁸⁾							
1.6	76		01.94	04.96	- Servolenkung/ - Klimaanlage ⁸⁾							
1.3 Rallye	72		10.93	04.96	+ Servolenkung ⁷⁾	24.3728-0814.2	590814			L=678		
1.4	51		08.91	03.96	+ Servolenkung ⁷⁾							
1.4	55		08.91	04.96	+ Servolenkung ⁷⁾							

¹⁾ - ABS/ + 3 door / - ABS/ + 3 porte / - ABS/ + 3 portes / - ABS/ + 3 puertas
²⁾ + 4 bore wheel rim / + cerchione a 4 fori / + jante à 4 trous / + Llantas de 4 taladros
³⁾ - ABS/ + 5 door / - ABS/ + 5 porte / - ABS/ + 5 portes / - ABS/ + 5 puertas
⁴⁾ + 3 bore wheel rim / + cerchione a 3 fori / + jante à 3 trous / + Llantas de 3 taladros
⁵⁾ f.3 bore wheel rim/-sensorring / p.cerchione a 3 fori/- sensore / p.jant.a 3 trous/- secours ABS / Liant.3 ta./-anillo sens.ABS
⁶⁾ - power steering / - servosterzo / - direction assistée / - dirección asistida
⁷⁾ + power steering / + servosterzo / + direction assistée / + dirección asistida
⁸⁾ - power steering/-air condition / - servosterzo/ + aria condizionata / - direc.assis./ - air conditionné / - direcc.asist./ - aire acondic.



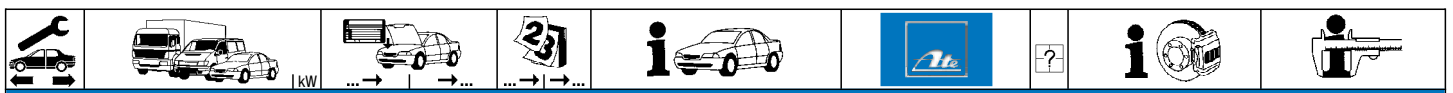

















PEUGEOT 106 (91-96)											
	1.4			08.91	04.96	+ Servolenkung ¹⁾	24.3728-0814.2	590814		L=678	
	1.4			08.91	03.96	+ Servolenkung ¹⁾					
	1.4 D			08.92	04.96	+ Servolenkung ¹⁾					
	1.6			06.93	04.96	+ Servolenkung/ + Klimaanlage ²⁾					
	1.6			01.94	04.96	+ Servolenkung/ + Klimaanlage ²⁾					
	1.5 D			06.94	04.96	+ Servolenkung ¹⁾	24.3728-0315.2	590315		L=673	
PEUGEOT 204 (65-77)											
	1.1 Cabrio			10.67	03.70		24.3219-1114.3	020323		Rz 19,05 BDX	
	1.1 Coupe			10.67	03.70						
	1.1 GL	9.254.614		10.65		+ (A)					
	1.1 GL			10.65	09.72	+ (M) (S)					
	1.1 Kombi	7.677.725		09.75		- (N) (S)					
	1.2 D	7.987.370		10.67		- (N) (S)					
1.2 D			10.67	09.72	+ (M) (S)						
1.3 D		8.341.273	10.74		- (N) (S)						
	1.1 GL	9.254.615		06.77			24.3223-1105.3	020292		Rz 23,81 BDX	
	1.1 Kombi	7.677.726		06.77							
	1.2 D	7.987.371		06.77							
	1.3 D	8.341.274		06.77							
	1.1 GL			07.75	06.77		03.0137-0139.2	650139		229 x 42 BDX	
	1.1 Kombi			07.75	06.77		03.0137-0124.2	650124		229 x 42 HEB AUT BDX	
	1.2 D			07.75	06.77		03.0137-0271.2	650271		229 x 42 HEB LUC	
	1.2 D			07.75	06.77		03.0137-9020.2	669020		Bremsbacken-Zubehör BDX	
	1.3 D			07.75	06.77		03.0137-9027.2	669027		Bremsbacken-Zubehör LUC	
PEUGEOT 205 (83-90)											
	1.0	33		01.83	08.85	- Bremsgerät ³⁾	03.2119-1281.3	010054		Thz 19,05 ATE	
	1.1			01.83	08.85	- Bremsgerät ³⁾					
	1.0	33		01.83	08.90	+ Bremsgerät ⁴⁾	03.2119-3389.3	010057	+ 4 Anschlüsse ⁵⁾	Thz 19,05 ATE	
	1.1			01.83	08.90	+ Bremsgerät ⁴⁾	03.2120-2031.3	010106	+ 4 Anschlüsse ⁵⁾	Thz 20,64 ATE	
	1.1 i			07.89	08.90		03.3517-5100.1	390326		Verschlußschraube ATE	
	1.3 Rallye			09.87	08.90						
	1.4			01.83	08.90						
	1.4 i			07.88	08.90						
	1.5			02.84	10.87						
	1.6			01.83	08.90						
	1.6	58		10.87	08.90	+ Automatikgetriebe ⁶⁾					
	1.6	65		05.90	08.90	+ Automatikgetriebe ⁶⁾					
	1.9 GTI	88		09.88	08.90	- ABS					
	1.9 GTI	94		10.86	08.88	- ABS					
	1.9 GTI/CTI	75		04.89	08.90						
	1.7 D	44		07.83	08.90		03.2119-3389.3	010057		Thz 19,05 ATE	
	1.9 D			09.88	08.90						
	1.0	33		01.83	08.90		24.3481-1609.7	220197	<input type="checkbox"/>	D=48, + Halter LUC	
	1.1			01.83	08.89		24.3481-1610.7	220198	<input type="checkbox"/>	D=48, + Halter LUC	
	1.4			01.83	08.90						
	1.6			01.83	02.87						
	1.7 D	44		07.83	08.90						
	1.9 D			09.88	08.90						
	1.1 i			07.89	08.90		24.3481-1609.7	220197	<input type="checkbox"/>	D=48, + Halter LUC	
	1.4 i			07.88	08.90		24.3481-1610.7	220198	<input type="checkbox"/>	D=48, + Halter LUC	
	1.6			03.87	08.90						
	1.6	58		10.87	08.90	+ Automatikgetriebe ⁶⁾					
	1.6	65		05.90	08.90	+ Automatikgetriebe ⁶⁾					
	1.6 GTI/CTI			01.84	08.90						
	1.9 GTI/CTI	75		04.89	08.90						
	1.9 GTI	88		09.88	08.90		24.3481-1615.5	240031	<input type="checkbox"/>	D=48, - Halter LUC	
	1.9 GTI	94		10.86	08.88		24.3481-1616.5	240032	<input type="checkbox"/>	D=48, - Halter LUC	
							24.0101-4806.2	260052		Bremsmittel-Zubehör LUC	
		1.0	33		01.83	08.90		13.0460-3911.2	603911		20905 18,0 +/-WK BDX
1.1				01.83	08.90		13.0460-2956.2	602956		20989 17,7 +/-WK LUC	
1.4				01.83	08.90		13.0460-0060.2	610060		Belagsatz-Zubehör LUC	
1.6				08.86	08.90		13.0460-0402.2	610402		Belagsatz-Zubehör BDX	
1.6		58		10.87	08.90	+ Automatikgetriebe ⁶⁾					
1.6		65		05.90	08.90	+ Automatikgetriebe ⁶⁾					
1.6 GTI/CTI				01.84	08.90						
1.7 D		44		07.83	08.90						
1.9 D				09.88	08.90						
1.1 i				09.89	08.90		13.0460-3911.2	603911		20905 18,0 +/-WK BDX	
1.3 Rallye				09.87	08.90		13.0460-2956.2	602956		20989 17,7 +/-WK LUC	
1.4 i				09.88	08.90		13.0460-0060.2	610060		Belagsatz-Zubehör LUC	
1.9 GTI/CTI		75		04.89	08.90		13.0460-0404.2	610404		Belagsatz-Zubehör BDX	
1.9 GTI		88		09.88	08.90		13.0460-2955.2	602955		20772 18,0 +/-WK/S LUC	
1.9 GTI		94		10.86	08.88						
		1.0	33		01.83	08.90		24.0110-0187.1	410187		247 10,0 9,0 +S +B
		1.1			01.83	08.90					
	1.1 i			07.89	08.90						
	1.4			01.83	08.90						
	1.4 i			07.88	08.90						
	1.6			08.86	02.87						
	1.7 D	44		07.83	08.90						
	1.9 D			09.88	08.90						
	1.3 Rallye			09.87	08.90		24.0120-0131.1	420131		247 20,4 18,5 V	
	1.6			03.87	08.90						
1.6	58		10.87	08.90	+ Automatikgetriebe ⁶⁾						

1) + power steering / + servosterzo / + direction assistée / + dirección asistida
2) + power steering/ +air condition. / + servosterzo/ + aria condizionata / + direc.assist. / + air conditionné / + direcc.asist./ + aire acondicion.
3) - booster unit / - servofreno / - servo-frein / - servofreno
4) + booster unit / + servofreno / + servo-frein / + servofreno
5) + 4 connections / + 4 attacchi / + 4 raccords / + 4 conexiones
6) + autom. transmission / + scatola cambio automatico / + transmission automatique / + cambio automático



												
PEUGEOT 205 (83-90)												
	1.6 1.6 GTI/CTI 1.9 GTI/CTI	65 75		05.90 01.84 04.89	08.90 08.90 08.90	+ Automatikgetriebe ¹⁾	24.0120-0131.1 420131	247 20,4 18,5 V				
	1.9 GTI 1.9 GTI	88 94		09.88 10.86	08.90 08.88		24.0120-0132.1 24.0320-0132.1	420132 520132				
								247 20,4 18,5 V +S +B 247 20,4 18,5 V +S +B PD				
	1.0 1.1 1.1 i 1.4 1.4 i 1.5 1.6 1.6 1.6 1.9 GTI 1.9 GTI 1.9 GTI/CTI	33 58 65 88 94 75		01.83 01.83 07.89 01.83 07.88 02.84 08.86 10.87 05.90 09.88 10.86 04.89	08.90 08.90 08.90 08.90 08.90 10.87 08.90 08.90 08.90 08.90 08.88 08.90	+ Automatikgetriebe ¹⁾ + Automatikgetriebe ¹⁾	24.5112-0325.3 24.5112-0405.3	330415 330428	2 2	Länge beachten ²⁾ Länge beachten ²⁾	L=355 L=405	
	1.3 Rallye 1.7 D 1.9 D	44		09.87 07.83 09.88	08.90 08.90 08.90		24.5112-0325.3 24.5112-0405.3	330415 330428	2 2	Länge beachten ²⁾ Länge beachten ²⁾	L=355 L=405	
	1.6 1.6 GTI 1.9 GTI 1.9 GTI	85 74 88 94		09.87 02.83 09.88 10.86	08.90 10.87 08.90 08.88		13.0460-3954.2 13.0460-0435.2	603954 610435			20973 11,0 + Belagsatz-Zubehör	BDX BDX
	1.6 1.6 GTI 1.9 GTI 1.9 GTI	85 74 88 94		09.87 02.83 09.88 10.86	08.90 10.87 08.90 08.88		24.0108-0105.1	408105			248 8,0 6,5	
	1.0 1.1 1.1 i 1.4 1.4 i 1.5 1.6 1.6 1.6 1.7 D 1.9 D	33 58 65 88 94 75		01.83 01.83 07.89 01.83 07.88 02.84 08.86 10.87 05.90 07.83 09.88	08.90 08.90 08.90 08.90 08.90 10.87 08.90 08.90 08.90 08.90 08.90	+ Automatikgetriebe ¹⁾ + Automatikgetriebe ¹⁾	24.5228-0255.3	330409	2		L=255	
	1.3 Rallye			09.87	08.90		24.5112-0230.3 24.5228-0255.3	330508 330409			L=230 L=255	
	1.6 1.9 GTI 1.9 GTI 1.9 GTI/CTI	85 88 94 75		09.87 09.88 10.86 04.89	08.90 08.90 08.88 08.90		24.5228-0255.3 24.5112-0155.3	330409 330507	2 2	Länge beachten ²⁾ Länge beachten ²⁾	L=255 L=155	
	1.0 1.1	33		01.83 01.83	08.90 08.89	- Bremsgerät ³⁾ - Bremsgerät ³⁾	24.3220-1609.3 24.3220-1610.3	020236 020237	<input type="checkbox"/> <input type="checkbox"/>		RzR 20,64 RzR 20,64	BDX BDX
	1.0 1.1 1.4 1.4 Kasten 1.6 1.7 D 1.9 D	33 44 44		01.83 01.83 02.83 08.86 07.83 09.88	08.90 08.89 08.90 02.87 08.90 08.90	+ Bremsgerät ⁴⁾ + Bremsgerät ⁴⁾	24.3219-1605.3 24.3219-1606.3 24.3219-1601.3 24.3219-1602.3	020202 020203 020198 020199	<input type="checkbox"/> <input type="checkbox"/> <input type="checkbox"/> <input type="checkbox"/>		RzR 19,05 RzR 19,05 RzR 19,05 RzR 19,05	BDX BDX LUC LUC
	1.1 i 1.3 Rallye 1.4 i 1.4 Kasten 1.6 1.6 1.6 1.6 GTI 1.9 GTI/CTI	44 58 65 74 75		07.89 09.87 07.89 02.83 03.87 10.87 05.90 01.84 04.89	08.90 08.90 08.90 07.87 08.90 08.90 08.90 08.90 08.90	+ Automatikgetriebe ¹⁾ + Automatikgetriebe ¹⁾	24.3219-1118.3	020332			Rz 19,05	LUC
	1.0 1.1 1.4 1.6 1.7 D 1.9 D	33 44		01.83 01.83 01.83 08.86 07.83 09.88	08.90 08.89 08.90 02.87 08.90 08.90		03.0137-0196.2 03.0137-0197.2 03.0137-9055.2 03.0137-9175.2	650196 650197 669055 669175			180 x 32 AUT 180 x 32 HEB Bremsbacken-Zubehör Bremsbacken-Zubehör	BDX LUC BDX LUC
	1.1 i 1.3 Rallye 1.4 i 1.6 1.6 1.6 1.6 GTI 1.9 GTI/CTI	58 65 74 75		07.89 09.87 07.88 03.87 10.87 05.90 01.84 04.89	08.90 08.90 08.90 08.90 08.90 08.90 08.90 08.90	+ Automatikgetriebe ¹⁾ + Automatikgetriebe ¹⁾	03.0137-0201.2 03.0137-9056.2	650201 669056			180 x 41 HEB Bremsbacken-Zubehör	LUC LUC
	1.0 1.1 1.4 1.6 1.7 D 1.9 D	33 44		01.83 01.83 01.83 08.86 07.83 09.88	08.90 08.89 08.90 02.87 08.90 08.90		24.0218-0014.1	480009			180/181 x 43 - Lager	
	1.1 i 1.3 Rallye			07.89 09.87	08.90 08.90		24.0218-0015.1	480010			180/181 x 53,5 - Lager	

¹⁾ + autom.transmission / + scatola cambio automatico / + transmission automatique / + cambio automático

²⁾ notice length / attenzione lunghezza / faire attention longueur / atención largo

³⁾ - booster unit / - servofreno / - servo-frein / - servofreno

⁴⁾ + booster unit / + servofreno / + servo-frein / + servofreno

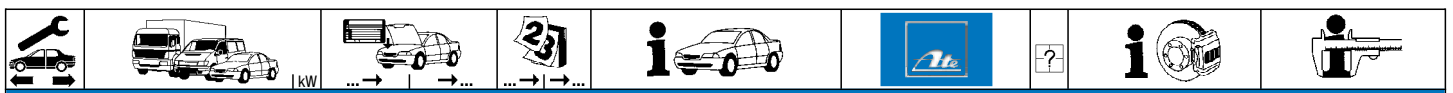

PEUGEOT 205 (83-90)

	1.4 i 1.6 1.6 1.6 1.6 GTI 1.9 GTI/CTI			07.88 03.87 10.87 05.90 01.84 04.89	08.90 08.90 + Automatikgetriebe 1) + Automatikgetriebe 1) 08.90 08.90	24.0218-0015.1	480010			180/181 x 53,5 - Lager
	1.0 1.1	33		01.83 01.83	08.90 08.89	- Bremsgerät 2) - Bremsgerät 2)	03.0520-2420.3	692420		20,64/180x32 TopKit BDX
	1.0 1.1 1.4 1.6 1.7 D 1.9 D	33 44		01.83 01.83 01.83 08.86 07.83 09.88	08.90 08.89 + Bremsgerät 3) + Bremsgerät 3) 02.87 08.90 08.90		03.0520-0619.3 03.0520-0419.3	690619 690419		19,05/180x32 TopKit BDX 19,05/180x32 TopKit LUC
	1.1 i 1.3 Rallye 1.4 i 1.6 1.6 1.6 1.6 GTI 1.9 GTI/CTI			07.89 09.87 07.88 03.87 10.87 05.90 01.84 04.89	08.90 08.90 08.90 + Automatikgetriebe 1) + Automatikgetriebe 1) 08.90 08.90		03.0520-0919.3	690919		19,05/180x41 TopKit LUC
	1.0 1.1 1.1 i 1.3 Rallye 1.4 1.4 i 1.5 1.6 1.6 1.6 1.7 D 1.9 D 1.9 GTI/CTI	33		01.83 01.83 07.89 09.87 01.83 07.88 02.84 08.86 10.87 05.90 07.83 09.88 04.89	08.90 08.90 08.90 08.90 + Automatikgetriebe 1) + Automatikgetriebe 1) 10.87 08.90 08.90		24.3727-0802.2 24.3727-0801.2	580802 580801	<input type="checkbox"/> <input checked="" type="checkbox"/>	L=1372 L=1386
	1.9 GTI 1.9 GTI	88 94		09.88 10.86	08.90 08.88		24.3727-0810.2 24.3727-0811.2	580810 580811	<input type="checkbox"/> <input checked="" type="checkbox"/>	L=1417 L=1432
	1.9 GTI 1.9 GTI	94 94	S 1831920 S 1811241	10.86 10.86	- ABS/ + (E) - ABS/ - (E)		24.6043-1701.3	320150		BRE 3/15
	1.9 GTI 1.9 GTI	88 S 1811242 88 S 1831921		08.90 08.90	- ABS/ - (E) - ABS/ + (E)		24.6042-1701.3	320149		BRE 2/20
	1.3 Rallye 1.4	44 44		08.88 08.88	07.89 + MA-Getriebe 4) 07.89 + MA-Getriebe 4)		24.3728-0807.2	590807		L=1262
	1.0 1.1 1.1 i	33		08.89 08.89 07.89	08.90 + MA-Getriebe 4) 08.90 + MA-Getriebe 4) 08.90 + MA-Getriebe 4)		24.3728-0810.2	590810		L=625
	1.3 Rallye 1.4	44 44		08.89 08.89	08.90 + MA-Getriebe 4) 08.90 + MA-Getriebe 4)		24.3728-0811.2	590811		L=1271
	1.6 1.7 D 1.9 GTI/CTI	44 44		01.84 07.83 10.86	07.88 + BE1-Getriebe 5) 07.88 + BE1-Getriebe 5) 07.88 + BE1-Getriebe 5)		24.3728-0803.2	590803		L=705
	1.6 1.7 D 1.9 GTI/CTI	44 44		08.88 08.88 08.88	08.90 + BE1-Getriebe 5) 08.90 + BE1-Getriebe 5) 08.90 + BE1-Getriebe 5)		24.3728-0806.2	590806		L=710
	1.6 GTI/CTI 1.7 D 1.9 GTI/CTI	44 44		09.89 09.89 09.89	08.90 + BE3-Getriebe 6) 08.90 + BE3-Getriebe 6) 08.90 + BE3-Getriebe 6)		24.3728-0813.2	590813		L=660

PEUGEOT 304 (69-80)























	1.3 Cabrio 1.3 Cabrio 1.3 Coupe 1.3 Coupe 1.3 Kombi 1.3 Kombi 1.3 Lim. 1.3 Lim.	48 48 48 48	3.298.000 3.298.000 3.733.769 3.733.769	03.70 03.70 03.70 09.70 09.70 09.69 09.69	- (N) (S) + (N) (S) - (N) (S) + (N) (S) - (N) (S) + (N) (S) - (N) (S) + (N) (S)	24.3219-1114.3	020323			Rz 19,05 BDX
	1.1 1.3 Kombi 1.4 D Lim.	43 33	3.733.770 3.733.770 3.733.770	10.80 10.80 10.79		24.3223-1105.3	020292			Rz 23,81 BDX
	1.1 1.3 Cabrio 1.3 Kombi 1.3 Lim. 1.4 D Lim.	43 55 33		10.76 07.75 07.75 07.75 10.76	10.80 07.76 10.80 09.75 10.80	03.0137-0139.2 03.0137-0124.2 03.0137-0271.2 03.0137-9020.2 03.0137-9027.2	650139 650124 650271 669020 669027			229 x 42 BDX 229 x 42 HEB AUT BDX 229 x 42 HEB LUC Bremsbacken-Zubehör BDX Bremsbacken-Zubehör LUC

PEUGEOT 305 (77-90)

	1.3 Kombi 1.3 Lim. 1.5 D Kombi 1.5 D Lim. 1.5 Kombi 1.5 Lim.	8.619.360 8.622.710 8.619.360 8.622.710 8.619.360 8.622.710		08.86 08.85 09.82 09.82 10.86 07.90		24.2119-1704.3	010339			Thz 19,05
	1.3 1.5			10.82 10.82	08.86 08.86	03.2119-3389.3 03.3517-5100.1	010057 390326			Thz 19,05 ATE Verschlusschraube ATE

































1) + autom.transmission / + scatola cambio automatico / + transmission automatique / + cambio automático
 2) - booster unit / - servofreno / - servo-frein / - servofreno
 3) + booster unit / + servofreno / + servo-frein / + servofreno
 4) + MA transmission / + scatola cambio MA / + boîte de vitesse MA / + cambio MA
 5) + BE1 transmission / + scatola cambio BE1 / + boîte de vitesse BE1 / + cambio BE1
 6) + BE3 transmission / + scatola cambio BE3 / + boîte de vitesse BE3 / + cambio BE3



										
PEUGEOT 305 (77-90)										
	1.6 1.8 1.8 D 1.9 1.9 D 1.9 i	59 44 75 72		10.82 11.82 11.82 10.82 10.82 10.86	12.88 12.88 12.88 10.87 12.88 12.88	03.2119-3389.3 03.3517-5100.1	010057 390326	THz 19,05 Verschlusschraube	ATE ATE	
	1.3 1.5 1.6 1.6 GT 1.8 1.8 D 1.9 1.9 D 1.9 i	59 44 75 72		10.82 10.82 10.82 07.84 11.82 11.82 10.82 10.82 10.86	08.86 07.90 12.88 08.87 12.88 12.88 10.87 12.88 12.88	13.0460-3911.2 13.0460-0402.2	603911 610402	20905 18,0 +/WK Belagsatz-Zubehör	BDX BDX	
	1.3 1.5 1.6 1.8 1.8 D 1.9 D 1.6 GT 1.9 1.9 i	59 44 75 72		10.82 10.82 10.82 11.82 11.82 10.82 07.84 10.82 10.86	08.86 07.90 12.88 12.88 12.88 12.88 08.87 10.87 12.88	13.0460-3911.2 13.0460-0404.2	603911 610404	20905 18,0 +/WK Belagsatz-Zubehör	BDX BDX	
	1.3 1.5 1.6 1.8 1.8 D 1.9 D 1.6 GT 1.9 1.9 i	59 44 75 72		10.82 10.82 10.82 11.82 11.82 10.82 07.84 10.82 10.86	08.86 07.90 12.88 12.88 12.88 12.88 08.87 10.87 12.88	24.0110-0183.1	410183	266 10,0 8,0		
	1.3 Lim. 1.5 D Lim. 1.5 Lim. 1.6 Lim. 1.8 1.8 D 1.9 D Lim. 1.9 i Lim. 1.9 Lim.	59 44 72 75		11.77 11.77 11.79 10.82 11.82 11.82 10.82 11.86 10.82	08.85 09.82 07.90 07.88 12.88 12.88 07.88 12.88 08.85	24.5228-0215.3	330529	2	L=215	
	1.3 Kombi 1.5 D Kombi 1.5 Kombi 1.6 Kombi 1.8 1.8 D 1.9 D Kombi 1.9 i Kombi 1.9 Kombi	59 44 72 75		08.80 08.80 08.80 10.82 11.82 11.82 10.82 11.86 10.82	08.86 09.82 10.86 12.88 12.88 12.88 12.88 12.88 10.87	24.5228-0185.3	330107	2	L=185	
	1.3 Lim. 1.5 D Lim. 1.5 Lim. 1.3 Lim. 1.5 D Lim. 1.5 Lim. 1.3 Lim. 1.5 Lim. 1.6 GT 1.6 Lim. 1.8 1.8 D 1.9 D Lim. 1.9 i Lim. 1.9 Lim.	8.209.617 8.209.617 8.209.617		09.82 09.82 09.82 11.77 11.77 11.79 10.82 10.82 07.84 10.82 11.82 11.82 10.82 11.86 10.82	08.85 09.82 09.82 09.82 09.82 08.85 07.90 08.87 07.88 12.88 12.88 07.88 12.88 08.85	24.3222-1708.3	020407		Rz 22,20	ATE
	1.3 Lim. 1.5 D Lim. 1.5 Lim. 1.3 Lim. 1.5 Lim. 1.6 GT 1.6 Lim. 1.8 1.8 D 1.9 D Lim. 1.9 i Lim. 1.9 Lim.			11.77 11.77 11.79 10.82 10.82 07.84 10.82 11.82 11.82 10.82 11.86 10.82	09.82 09.82 09.82 08.85 07.90 08.87 07.88 12.88 12.88 07.88 12.88 08.85	24.3223-1105.3	020292		Rz 23,81	BDX
	1.3 Lim. 1.5 Lim. 1.6 GT 1.6 Lim. 1.8 1.8 D 1.9 D Lim. 1.9 i Lim. 1.9 Lim.	59 44 75		10.82 10.82 07.84 10.82 11.82 11.82 10.82 11.86 10.82	08.85 07.90 08.87 07.88 12.88 12.88 07.88 12.88 08.85	24.3220-1115.3 24.3220-0905.3	020312 020207		Rz 20,64 Rz 20,64	BDX LUC
	1.3 Kombi 1.5 Kombi 1.6 Kombi 1.8 1.8 D 1.9 D Kombi 1.9 i Kombi 1.9 Kombi	59 44 72 75		10.82 10.82 10.82 11.82 11.82 10.82 11.86 10.82	08.86 10.86 12.88 12.88 12.88 12.88 12.88 12.88	24.3220-0905.3	020207		Rz 20,64	LUC
	1.3 1.5 1.5 D 1.3 1.5 1.5 D 1.3 1.5 1.6 1.6 GT 1.8 1.8 D 1.9 1.9 D 1.9 i	59 44 75 72		11.77 11.79 11.77 11.77 11.79 11.77 10.82 10.82 10.82 07.84 11.82 11.82 10.82 10.82 11.86	09.82 09.82 09.82 09.82 09.82 09.82 08.86 08.86 12.88 08.87 12.88 12.88 10.87 12.88 12.88	03.0137-0124.2 03.0137-0139.2 03.0137-9020.2	650124 650139 669020		229 x 42 HEB AUT 229 x 42 Bremsbacken-Zubehör	BDX BDX BDX
	1.3 1.5 1.5 D 1.3 1.5 1.6 1.6 GT 1.8 1.8 D 1.9 1.9 D 1.9 i	59 44 75 72		11.77 11.79 11.77 10.82 10.82 10.82 07.84 11.82 11.82 10.82 10.82 11.86	09.82 09.82 09.82 08.86 08.86 12.88 08.87 12.88 12.88 10.87 12.88 12.88	03.0137-0271.2 03.0137-9027.2	650271 669027		229 x 42 HEB Bremsbacken-Zubehör	LUC LUC
	1.3 1.5 1.6 1.6 GT 1.8 1.8 D 1.9 1.9 D 1.9 i	59 44 75 72		10.82 10.82 10.82 07.84 11.82 11.82 10.82 10.82 11.86	08.86 08.86 12.88 08.87 12.88 12.88 10.87 12.88 12.88	03.0137-0285.2 03.0137-9188.2	650285 669188		229 x 42 AUT Bremsbacken-Zubehör	BDX BDX

PEUGEOT 309 (85-93)												
	1.1	47	09.85	12.93	03.2119-3389.3 03.3517-5100.1	010057 390326						THz 19,05 Verschlusschraube ATE ATE
	1.3											
	1.4											
	1.5											
	1.6											
	1.8 D											
	1.8 TD											
	1.9											
	1.9 D											
	1.9 GTi											
	1.9 GTi	88	09.88	12.93	03.2120-2031.3	010106						THz 20,64 ATE
	1.9 GTi											
	1.9 GTi											
	1.9 GTi 16V											
	1.9 i											
	1.9 i											
	1.9 i											
	1.9 i											
	1.9 i											
	1.9 i											
	1.1	47	09.85	12.93	24.3481-1609.7 24.3481-1610.7	220197 220198						D=48, + Halter D=48, + Halter LUC LUC
	1.3											
	1.4											
	1.5											
	1.6											
	1.6											
	1.8 D											
	1.8 TD											
	1.9											
	1.9 D											
	1.9 D	44	07.89	12.93	24.3481-1615.5 24.3481-1616.5 24.0101-4806.2	240031 240032 260052					D=48, - Halter D=48, - Halter D=48, + Halter D=48, + Halter LUC LUC LUC LUC	
	1.8 TD											
	1.9											
	1.9 D											
	1.9 i											
	1.9 i											
	1.9 i											
	1.9 i											
	1.9 i											
	1.9 i											
	1.9 GTi	88	09.88	12.93	13.0460-3911.2 13.0460-2956.2 13.0460-0060.2 13.0460-0402.2	603911 602956 610060 610402					20905 18,0 +/WK 20989 17,7 +/WK Belagsatz-Zubehör Belagsatz-Zubehör BDX LUC LUC LUC BDX	
	1.9 GTi											
	1.9 GTi											
	1.9 GTi											
	1.9 GTi 16V											
	1.9 GTi											
	1.9 GTi											
	1.9 GTi											
	1.9 GTi											
	1.9 GTi											
	1.9 GTi	88	09.88	12.93	13.0460-3911.2 13.0460-2955.2 13.0460-0404.2	603911 602955 610404					20905 18,0 +/WK 20772 18,0 +/WK/S Belagsatz-Zubehör BDX LUC LUC BDX	
	1.9 GTi											
	1.9 GTi											
	1.9 GTi											
	1.9 GTi 16V											
	1.9 GTi											
	1.9 GTi											
	1.9 GTi											
	1.9 GTi											
	1.9 GTi											
	1.1	47	09.85	12.93	24.0110-0187.1	410187						247 10,0 9,0 +S +B
	1.3											
	1.4											
	1.5											
	1.6											
	1.8 D											
	1.8 TD											
	1.9											
	1.9											
	1.9											
	1.9 D	44	07.89	12.93	24.0120-0132.1 24.0320-0132.1	420132 520132					247 20,4 18,5 V +S +B 247 20,4 18,5 V +S +B PD	
	1.8 TD											
	1.9											
	1.9											
	1.9											
	1.9 D											
	1.9 GTi											
	1.9 GTi											
	1.9 GTi											
	1.9 GTi 16V											
	1.1	47	09.85	08.89	24.5112-0327.3	330417	2					L=325
	1.3											
	1.4											
	1.5											
	1.6											
	1.8 D											
	1.8 TD											
	1.9											
	1.9											
	1.9											
	1.9 D	44	07.89	08.89	24.5112-0327.3 24.5112-0405.3	330417 330428	2 2				L=325 L=405	
	1.8 TD											
	1.9											
	1.9 D											
	1.9 i											
	1.9 i											
	1.9 i											
	1.9 i											
	1.9 i											
	1.9 i											

1) + manual transmission / + scatola cambio velocità / + transmission mécanique / + cambio de velocidad
2) + autom.transmission / + scatola cambio automatico / + transmission automatique / + cambio automatico
3) notice length / attenzione lunghezza / faire attention longueur / atención largo

									
PEUGEOT 309 (85-93)									
	1.9 GTI 1.9 GTI 1.9 GTI 1.9 GTI 16V 1.9 i	88 94 96 80	09.88 12.93 10.86 07.89 10.86 12.93 08.89 12.93 07.88 08.89	+ ⊕ + ⊕ - ⊕ + ⊕ - ⊕	24.5112-0405.3	330428	2	L=405	
	1.6 GTi 1.9 GTI 1.9 GTI 1.9 GTI 1.9 GTI 16V	76 88 94 96	03.86 12.93 09.88 12.93 10.86 07.89 10.86 12.93 08.89 12.93	+ ⊕ + ⊕ - ⊕ - ⊕	13.0460-3954.2 13.0460-0435.2	603954 610435		20973 11,0 + Belagsatz-Zubehör BDX BDX	
	1.6 GTi 1.9 GTI 1.9 GTI 1.9 GTI 1.9 GTI 16V	76 88 94 96	03.86 12.93 09.88 12.93 10.86 07.89 10.86 12.93 08.89 12.93	+ ⊕ + ⊕ + ⊕ - ⊕	24.0108-0105.1	408105		248 8,0 6,5	
	1.1 1.3 1.4 1.5 1.6 1.8 D 1.8 TD 1.9 1.9 D 1.9 D 1.9 i 1.9 i	47 44 57 75 72 80	09.85 08.89 09.85 07.89 03.89 08.89 06.87 08.89 09.85 08.89 07.89 08.89 07.89 08.89 09.85 07.89 08.89 06.86 08.89 03.86 08.89 07.88 08.89		24.5112-0230.3 24.5228-0255.3	330508 330409		L=230 L=255	
	1.1 1.4 1.5 1.6 1.8 D 1.8 TD 1.9 D 1.9 D 1.9 i 1.9 i	44 57 72 80	09.89 12.93 09.89 12.93 09.89 12.93 09.89 12.93 09.89 12.93 09.89 12.93 09.89 12.93 09.89 12.93 09.89 12.93 09.89 12.93 09.89 12.93		24.5228-0255.3	330409	2	L=255	
	1.6 GTi 1.9 GTi 1.9 GTi 1.9 GTi 1.9 GTi 16V	76 88 94 96	03.86 12.93 09.88 12.93 10.86 07.89 10.86 12.93 08.89 12.93	+ ⊕ + ⊕ + ⊕ - ⊕	24.5228-0255.3 24.5112-0155.3	330409 330507		L=255 L=155	
	1.1 1.4 1.5 1.6 1.9 1.9 1.9 D 1.9 i 1.6 1.9 1.9 D 1.9 i 1.8 D 1.8 TD 1.8 D 1.8 TD	72 75 80 72 75 80 44 57 44 57 44 57	09.89 12.93 09.89 12.93 09.89 12.89 09.85 08.89 03.87 08.89 10.85 07.89 06.86 08.89 07.88 08.89 09.89 12.93 03.89 12.93 09.89 12.93 09.89 12.93 07.89 08.89 07.89 08.89 09.89 12.93 09.89 12.93		24.3220-1609.3 24.3220-1610.3 24.3220-1607.3 24.3220-1608.3 24.3222-1709.3 24.3222-1710.3 24.3222-1106.3 24.3222-1107.3 24.3220-1607.3 24.3220-1608.3 24.3222-1709.3 24.3222-1710.3 24.3220-1619.3	020236 020237 020234 020235 020111 020112 020261 020262 020234 020235 020111 020112 020246	             	RzR 20,64 RzR 20,64 RzR 20,64 RzR 20,64 Rz 22,20 Rz 22,20 Rz 22,20 Rz 22,20 RzR 20,64 RzR 20,64 Rz 22,20 Rz 22,20 Rz 22,20 Rz 22,20 Rz 20,64	BDX BDX LUC LUC BDX BDX LUC LUC LUC LUC BDX BDX LUC
	1.1 1.3 1.5 1.1 1.4 1.5 1.6 1.8 D 1.8 TD 1.9 1.9 D 1.9 i 1.9 1.6 1.9 1.9 D 1.9 i	47 44 57 75 80 72	09.85 08.89 09.85 07.89 06.87 08.89 09.89 12.93 03.89 12.93 09.89 12.89 09.85 08.89 07.89 08.89 07.89 08.89 09.85 07.89 06.86 08.89 07.88 08.89 03.86 12.93 09.85 12.93 09.85 07.89 06.86 12.93 07.88 12.93		03.0137-0203.2 03.0137-9055.2 03.0137-0196.2 03.0137-0197.2 03.0137-9055.2 03.0137-9175.2 03.0137-0203.2 03.0137-9055.2 03.0137-0201.2 03.0137-9056.2	650203 669055 650196 650197 669055 669175 650203 669055 650201 669056		180 x 42 AUT Bremsbacken-Zubehör BDX BDX 180 x 32 AUT 180 x 32 HEB Bremsbacken-Zubehör BDX LUC Bremsbacken-Zubehör BDX LUC 180 x 42 AUT Bremsbacken-Zubehör BDX BDX 180 x 42 AUT 180 x 41 HEB Bremsbacken-Zubehör BDX LUC Bremsbacken-Zubehör BDX LUC 180 x 41 HEB Bremsbacken-Zubehör LUC LUC	
	1.1 1.3 1.4 1.5 1.6	47	09.85 08.89 09.85 07.89 03.89 08.89 06.87 08.89 09.85 08.89		24.0218-0015.1	480010		180/181 x 53,5 - Lager	

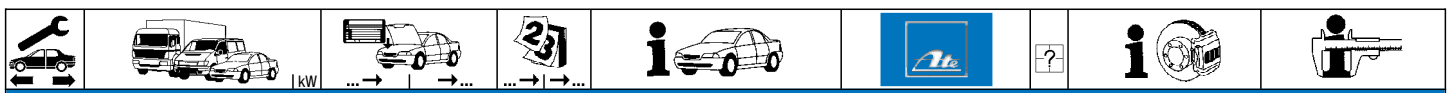

PEUGEOT 309 (85-93)

















	1.8 D	44		07.89	08.89	24.0218-0015.1	480010		180/181 x 53,5 - Lager
	1.8 TD	57		07.89	08.89				
	1.9	72		03.86	08.89				
	1.9	75		09.85	07.89				
	1.9 D			06.86	08.89				
	1.9 i	80		07.88	08.89				
	1.1			09.89	12.93	24.0218-0016.1	480011		180/181 x 44,5 - Lager
	1.4			09.89	12.93	24.0218-0716.2	480203		180/181 x 44,5 + Lager
	1.5			09.89	12.89				
	1.6			09.89	12.93				
1.8 D	44		09.89	12.93					
1.8 TD	57		09.89	12.93					
1.9	72		09.89	12.93					
1.9 D			09.89	12.93					
1.9 i	80		09.89	12.93					
	1.1			09.85	08.89	03.0520-1117.3	691117		17,46/180x42 TopKit BDX
	1.3	47		09.85	07.89				
	1.5			06.87	08.89				
	1.1			09.89	12.93	03.0520-2420.3	692420		20,64/180x32 TopKit BDX
	1.4			03.89	12.93	03.0520-1820.3	691820		20,64/180x32 TopKit LUC
	1.5			09.89	12.89				
	1.6			09.85	08.89	03.0520-0922.3	690922		22,20/180x42 TopKit BDX
	1.9	72		03.86	08.89				
	1.9	75		09.85	07.89				
	1.9 D			06.86	08.89				
	1.9 i	80		07.88	08.89				
	1.6			09.89	12.93	03.0520-2720.3	692720		20,64/180x41 TopKit LUC
	1.9	72		09.89	12.93				
	1.9 D			09.89	12.93				
1.9 i	80		09.89	12.93					
1.8 D	44		07.89	08.89	03.0520-0922.3	690922		22,20/180x42 TopKit BDX	
1.8 TD	57		07.89	08.89					
1.8 D	44		09.89	12.93	03.0520-3120.3	693120		20,64/180x41 TopKit LUC	
1.8 TD	57		09.89	12.93					
	1.1			09.85	12.93	24.3727-0806.2	580806	<input type="checkbox"/> + HA-Trommelbremse ¹⁾	L=1426
	1.3	47		09.85	07.89	24.3727-0805.2	580805	<input type="checkbox"/> + HA-Trommelbremse ¹⁾	L=1445
	1.4			03.89	12.93				
	1.5			06.87	12.89				
	1.6			09.85	12.93				
	1.8 D	44		07.89	12.93				
	1.8 TD	57		07.89	12.93				
	1.9	75		09.85	07.89				
	1.9 D			06.86	12.93				
	1.9 i	72		03.86	12.93				
1.9 i	80		07.88	12.93					
	1.1	S 2815520		08.90	08.90	24.6042-1701.3	320149		BRE 2/20
	1.3	47 S 2815520		07.89	07.89				
	1.4			03.89	08.90				
	1.5	S 2815520		12.89	12.89				
	1.6	S 2815520		08.90	08.90				
	1.8 D	44		07.89	08.90	- ABS			
	1.8 TD	57		07.89	08.90	- ABS			
	1.9	72 S 2815520		07.88	08.90	- ABS			
	1.9	75 S 2815520		07.89	08.90	- ABS			
	1.9	80 S 2815520		08.90	08.90	- ABS			
1.9 D	S 2815520		08.90	08.90					
1.9 GTi	88	S 2851976	09.88		24.6043-1701.3	320150		BRE 3/15	
1.9 GTi	94	S 2851976	10.86						
1.9 GTi	96	S 2851976	10.86						
	1.1	◀		09.85	07.89	+ MA-Getriebe ²⁾	24.3728-0807.2	590807	L=1262
	1.4	◀		03.89	07.89	+ MA-Getriebe ²⁾			
	1.1	◀		08.89	12.93	+ MA-Getriebe ²⁾	24.3728-0810.2	590810	L=625
	1.4	◀ 49		08.89	12.93	+ MA-Getriebe ²⁾			
	1.4 i	◀ 55		08.89	12.93	+ MA-Getriebe ²⁾			
	1.6	◀		08.89	12.93	+ MA-Getriebe ²⁾			
	1.8 D	◀ 44		08.89	12.93	+ MA-Getriebe ²⁾			
	1.8 TD	◀ 57		08.89	12.93	+ MA-Getriebe ²⁾			
	1.9	◀		08.89	12.93	+ MA-Getriebe ²⁾			
	1.4 i	◀ 62		03.89	12.93	+ MA-Getriebe ²⁾	24.3728-0811.2	590811	L=1271
	1.6	◀		09.85	07.88	+ XU-Motor/ + BE1-Getriebe ³⁾	24.3728-0803.2	590803	L=705
	1.9	◀		09.85	07.88	+ XU-Motor/ + BE1-Getriebe ³⁾			
	1.6	◀		08.88	12.93		24.3728-0806.2	590806	L=710
	1.9	◀		08.88	12.93				
	1.5	◀		06.87	12.89	+ BE3-Getriebe ⁴⁾	24.3728-0813.2	590813	L=660
1.6	◀		09.85	12.93	+ BE3-Getriebe ⁴⁾				
1.8 TD	◀ 57		07.89	12.93	+ BE3-Getriebe ⁴⁾				
1.9	◀		09.85	12.93	+ BE3-Getriebe ⁴⁾				



















PEUGEOT 404 (62-75)

	1.6			07.66	09.68	24.3219-1114.3	020323		Rz 19,05 BDX
--	-----	--	--	-------	-------	----------------	--------	--	--------------

1) + RA drum brake / + P freno a tamburo / + frein à tambour essieu AR / + ET-tambores de freno
 2) + MA transmission / + scatola cambio MA / + boîte de vitesse MA / + cambio MA
 3) + XU engine / + BE1 transmission / + motore XU / + scatola cambio BE1 / + moteur XU / + boîte vitesse BE1 / + motor de XU / + cambio BE1
 4) + BE3 transmission / + scatola cambio BE3 / + boîte de vitesse BE3 / + cambio BE3



								
PEUGEOT 405 (87-92)								
	1.6 1.9	70		09.87 09.87	08.92 08.92	24.2120-1701.3	010427	THz 20,64
	1.8 TD 1.9 1.9 1.9 i 1.9 i 1.9 Mi 16 1.9 Mi 16	66 80 93 77 88 108 116		09.88 09.88 07.87 09.87 09.88 05.88 09.87	08.92 + ABS 08.92 + ABS 08.92 + ABS 08.88 + ABS 08.92 + ABS 08.92 + ABS 12.88 + ABS	24.2122-1704.3	010423	THz 22,20
	1.8 TD 1.9 1.9 D	66 70 S 70536852 S 70536852		09.90 08.92 08.92	08.92 08.92 08.92	24.3481-1707.5 24.3481-1708.5 24.0101-3601.2	240073 240074 260044	D=48, - Halter LUC D=48, - Halter LUC Bremsattel-Zubehör LUC
	1.9 1.9 1.9 i 1.9 i 1.9 Mi 16 1.9 Mi 16	80 93 77 88 108 116		09.88 07.87 09.87 09.88 05.88 09.87	08.92 08.92 08.88 08.92 08.92 12.88	24.0101-3601.2	260044	Bremsattel-Zubehör LUC
	1.4 i 1.6 1.8 D Kombi 1.8 TD 1.9 1.9 D	47 66 70	S 70536851 S 70536851	01.87 09.87 03.88 09.88 09.87 05.88	08.92 08.92 08.92 + ⊕ 08.90 08.92 05.88	13.0460-3911.2 13.0460-0402.2	603911 610402	20905 18,0 +/WK BDX Belagsatz-Zubehör BDX
	1.6 1.8 TD 1.9 1.9 1.9 D 1.9 i 1.9 i 1.9 Mi 16 1.9 Mi 16	66 70 S 70536852 80 93 S 70536852 77 88 108 116		09.87 09.90 08.92 09.88 07.87 09.87 09.88 05.88 09.87	08.92 08.92 08.92 08.92 08.92 08.88 08.92 08.92 12.88	13.0460-2971.2	602971	21209 18,5 +/WK/S LUC
	1.4 i 1.6 1.8 D Kombi 1.8 TD 1.9 1.9 D	47 66 70	S 70536851 S 70536851	01.87 09.87 03.88 09.88 09.87 05.88	08.92 08.92 08.92 + ⊕ 08.90 08.92 05.88	24.0110-0183.1	410183	266 10,0 8,0
	1.8 TD 1.9 1.9 1.9 D 1.9 i 1.9 i 1.9 Mi 16 1.9 Mi 16	66 70 S 70536852 80 93 S 70536852 77 88 108 116		09.90 08.92 09.88 07.87 08.92 09.87 09.88 05.88 09.87	08.92 08.92 08.92 08.92 08.88 08.92 08.92 12.88	24.0120-0133.1 24.0320-0133.1	420133 520133	266 20,5 18,5 V +S +B 266 20,5 18,5 V +S +B PD
	1.4 i 1.6 1.8 D Kombi 1.8 TD 1.9 1.9 1.9 D 1.9 i 1.9 i 1.9 Mi 16 1.9 Mi 16	47 66 70 80 93 77 88 108 116		01.87 09.87 03.88 09.88 09.87 07.87 05.88 09.87 09.88 05.88 09.87	08.92 08.92 08.92 + ⊕ 08.92 08.92 08.92 08.88 08.92 08.92 12.88	24.5118-0470.3 24.5118-0420.3	330462 330444	L=470 L=420
	1.9 1.9 1.9 i 1.9 i 1.9 Mi 16 1.9 Mi 16	80 93 77 88 108 116		09.88 07.87 09.87 09.88 05.88 09.87	08.92 08.92 08.88 08.92 08.92 12.88	24.3384-1605.5 24.3384-1606.5	240295 240296	D=38, - Halter LUC D=38, - Halter LUC
	1.9 1.9 1.9 i 1.9 i 1.9 Mi 16 1.9 Mi 16	80 93 77 88 108 116		09.88 07.87 09.87 09.88 05.88 09.87	08.92 08.92 08.88 08.92 08.92 12.88	13.0460-2842.2 13.0460-0072.2	602842 610072	20961 15,2 /S LUC Belagsatz-Zubehör LUC
	1.9 Mi 16 X4 1.9 X4	108 80		05.88 09.88	08.92 08.92	13.0460-2937.2 13.0460-0419.2	602937 610419	20961 15,2 /Zub/S LUC Belagsatz-Zubehör LUC
	1.9 1.9 1.9 i 1.9 i 1.9 Mi 16 1.9 Mi 16	80 93 77 88 108 116		09.88 07.87 09.87 09.88 05.88 09.87	08.92 08.92 08.88 08.92 08.92 12.88	24.0110-0199.1	410199	247 10,0 8,0
	1.9 Mi 16 X4 1.9 X4	108 80		05.88 09.88	08.92 08.92	24.0110-0187.1	410187	247 10,0 9,0 +S +B





























										
PEUGEOT 405 (87-92)										
	1.4 i	47	01.87	08.92	- Bremskraftregler ¹⁾	24.5111-0235.3	330477	1	L=234 L=180	
	1.6		09.87	08.92	- Bremskraftregler ¹⁾	24.5229-0181.3	330533	2		
	1.8 D Kombi		03.88	08.92	+ ⊕ / - Bremskraftregler ²⁾					
	1.9	70	09.87	08.92	- Bremskraftregler ¹⁾					
	1.9	80	09.88	08.92	- ABS/ - Bremskraftregler ³⁾					
	1.9	93	07.87	08.92	- ABS/ - Bremskraftregler ³⁾					
	1.9 D		05.88	08.92	- Bremskraftregler ¹⁾					
	1.9 i	77	09.87	08.88	- ABS/ - Bremskraftregler ³⁾					
	1.9 i	88	09.88	08.92	- ABS/ - Bremskraftregler ³⁾					
	1.9 Mi 16	108	05.88	08.92	- ABS/ - Bremskraftregler ³⁾					
	1.9 Mi 16	116	09.87	12.88	- ABS/ - Bremskraftregler ³⁾					
	1.4 i	47	01.87	08.92	+ Bremskraftregler ⁴⁾	24.5229-0181.3	330533	2		L=180
	1.6		09.87	08.92	+ Bremskraftregler ⁴⁾					
	1.8 D Kombi		03.88	08.92	+ ⊕ / + Bremskraftregler ⁵⁾					
	1.9	70	09.87	08.92	+ Bremskraftregler ⁴⁾					
	1.9	80	09.88	08.92	- ABS/ + Bremskraftregler ⁶⁾					
	1.9	93	07.87	08.92	- ABS/ + Bremskraftregler ⁶⁾					
	1.9 D		05.88	08.92	+ Bremskraftregler ⁴⁾					
1.9 i	77	09.87	08.88	- ABS/ + Bremskraftregler ⁶⁾						
1.9 i	88	09.88	08.92	- ABS/ + Bremskraftregler ⁶⁾						
1.9 Mi 16	108	05.88	08.92	- ABS/ + Bremskraftregler ⁶⁾						
1.9 Mi 16	116	09.87	12.88	- ABS/ + Bremskraftregler ⁶⁾						
1.8 TD	66	09.88	08.92	+ ABS	24.5229-0181.3	330533	2	Länge beachten ⁷⁾	L=180 L=234	
1.9	80	09.88	08.92	+ ABS	24.5111-0235.3	330477	2			
1.9	93	07.87	08.92	+ ABS						
1.9 i	77	09.87	08.88	+ ABS						
1.9 i	88	09.88	08.92	+ ABS						
1.9 Mi 16	108	05.88	08.92	+ ABS						
1.9 Mi 16	116	09.87	12.88	+ ABS						
1.4 i	47	01.87	08.92	- ABS	24.3220-1611.3	020238				RzR 20,64 RzR 20,64
1.6 Lim.		09.87	08.92	- ABS	24.3220-1612.3	020239				
1.8 TD Lim.	66	09.88	08.92	- ABS						
1.9 D Lim.		05.88	08.92	- ABS						
1.9 Lim.	70	09.87	08.92	- ABS						
1.4 i	47	01.87	08.92	+ ABS	24.3220-0905.3	020207		Rz 20,64	LUC	
1.6 Kombi		10.88	08.92							
1.6 Lim.		09.87	08.92	+ ABS						
1.8 D Kombi		10.88	08.92	+ ⊕						
1.8 TD Kombi	66	10.88	08.92							
1.8 TD Lim.	66	09.88	08.92	+ ABS						
1.9 D Kombi		10.88	08.92							
1.9 D Lim.		05.88	08.92	+ ABS						
1.9 Kombi	70	10.88	08.92							
1.9 Lim.	70	09.87	08.92							
	1.4 i	47	01.87	08.92	- ABS	03.0137-0202.2	650202		229 x 42 Bremsbacken-Zubehör	BDX
	1.6 Lim.		09.87	08.92	- ABS	03.0137-9089.2	669089			
	1.8 TD Lim.	66	09.88	08.92	- ABS					
	1.9 D Lim.		05.88	08.92	- ABS					
	1.9 Lim.	70	09.87	08.92	- ABS					
1.4 i	47	01.87	08.92	+ ABS	03.0137-0271.2	650271		229 x 42 HEB Bremsbacken-Zubehör	LUC	
1.6 Kombi		10.88	08.92		03.0137-9027.2	669027				
1.6 Lim.		09.87	08.92	+ ABS						
1.8 D Kombi		10.88	08.92	+ ⊕						
1.8 TD Kombi	66	10.88	08.92							
1.8 TD Lim.	66	09.88	08.92	+ ABS						
1.9 D Kombi		10.88	08.92							
1.9 D Lim.		05.88	08.92	+ ABS						
1.9 Kombi	70	10.88	08.92							
1.9 Lim.	70	09.87	08.92	+ ABS						
	1.4 i	47	01.87	08.92		24.0222-8017.1	480071		229/230 x 50,8	
	1.6		09.87	08.92						
	1.8 D Kombi		03.88	08.92	+ ⊕					
	1.8 TD	66	09.88	08.92						
	1.9 D	70	09.88	08.92						
	1.4 i	47	01.87	08.92	- ABS	03.0520-1220.3	691220		20,64/229x42 TopKit	BDX
	1.6 Lim.		09.87	08.92	- ABS					
	1.8 TD Lim.	66	09.88	08.92	- ABS					
	1.9 D Lim.		05.88	08.92	- ABS					
	1.9 Lim.	70	09.87	08.92	- ABS					
1.4 i	47	01.87	08.92	+ ABS	03.0520-4120.3	694120		20,64/229x42 TopKit	LUC	
1.6 Kombi		10.88	08.92							
1.6 Lim.		09.87	08.92	+ ABS						
1.8 D Kombi		10.88	08.92	+ ⊕						
1.8 TD Kombi	66	10.88	08.92							
1.8 TD Lim.	66	09.88	08.92	+ ABS						
1.9 D Kombi		10.88	08.92							
1.9 D Lim.		05.88	08.92	+ ABS						
1.9 Kombi	70	10.88	08.92							
1.9 Lim.	70	09.87	08.92	+ ABS						
	1.4 i	47	01.87	08.92		24.3727-0831.2	580831	1	L=1842 L=855 L=550	
	1.6		09.87	08.92		24.3727-0804.2	580804			
	1.8 D Kombi		03.88	08.92	+ ⊕	24.3727-0803.2	580803			
	1.8 TD	66	09.88	08.92						
	1.9 D	70	09.87	08.92						

¹⁾ - brake pressure regulator / - correttore di frenata / - correcteur de freinage / - corrector de frenado
²⁾ + ⊕ / - brake press.regulator / + ⊕ / - correttore di frenata / + ⊕ / - correcteur de freinage / + ⊕ / - corrector de frenado
³⁾ - ABS/ - brake press.regulator / - ABS/ - correttore di frenata / - ABS/ - correcteur de freinage / - ABS/ - corrector de frenado
⁴⁾ + brake pressure regulator / + correttore di frenata / + correcteur de freinage / + corrector de frenado
⁵⁾ + ⊕ / + brake press.regulator / + ⊕ / + correttore di frenata / + ⊕ / + correcteur de freinage / + ⊕ / + corrector de frenado
⁶⁾ - ABS/ + brake press.regulator / - ABS/ + correttore di frenata / - ABS/ + correcteur de freinage / - ABS/ + corrector de frenado
⁷⁾ notice length / attenzione lunghezza / faire attention longueur / atención largo

PEUGEOT 405 (87-92)										
	1.9	80		09.88	08.92	24.3727-0831.2	580831	1		L=1842
	1.9	93		07.87	08.92	24.3727-0809.2	580809			L=872
	1.9 i	77		09.87	08.88	24.3727-0808.2	580808			L=558
	1.9 i	88		09.88	08.92					
	1.9 Mi 16	108		05.88	08.92					
	1.9 Mi 16	116		09.87	12.88					
	1.4 i	47		01.87	08.92	03.6583-0037.3	320107			BRL 8/3 (4) ATE
	1.6			09.87	08.92					
	1.8 D Kombi			03.88	08.92 + (E)					
	1.8 TD	66		09.88	08.92					
	1.9	70		09.87	08.92					
	1.9	80		09.87	08.92					
	1.9	93		07.87	08.92					
	1.9 D			05.88	08.92					
	1.9 i	77		09.87	08.92					
	1.9 i	88		09.88	08.92					
	1.9 Mi 16	108		05.88	08.92					
	1.9 Mi 16	116		09.87	12.88					
	1.6			09.87	08.92 + BE3/5-Getriebe 1)	24.3728-0818.2	590818			L=1365
	1.8 TD	66		09.88	08.92 + BE3/5-Getriebe 1)					
	1.9	70		09.87	08.92 + BE3/5-Getriebe 1)					
	1.9	80		09.87	08.92 + BE3/5-Getriebe 1)					
	1.9	93		07.87	08.92 + BE3/5-Getriebe 1)					
	1.9 D			05.88	08.92 + BE3/5-Getriebe 1)					
	1.9 i	77		09.87	08.92 + BE3/5-Getriebe 1)					
	1.9 i	88		09.88	08.92 + BE3/5-Getriebe 1)					
	1.9 Mi 16	108		05.88	08.92 + BE3/5-Getriebe 1)					
	1.9 Mi 16	116		09.87	12.88 + BE3/5-Getriebe 1)					
	1.6			09.87	08.92 + BE1/5-Getriebe 2)	24.3728-0817.2	590817			L=735
	1.8 TD	66		09.88	08.92 + BE1/5-Getriebe 2)					
	1.9	70		09.87	08.92 + BE1/5-Getriebe 2)					
	1.9	80		09.87	08.92 + BE1/5-Getriebe 2)					
	1.9	93		07.87	08.92 + BE1/5-Getriebe 2)					
	1.9 D			05.88	08.92 + BE1/5-Getriebe 2)					
	1.9 i	77		09.87	08.92 + BE1/5-Getriebe 2)					
	1.9 i	88		09.88	08.92 + BE1/5-Getriebe 2)					
	1.9 Mi 16	108		05.88	08.92 + BE1/5-Getriebe 2)					
	1.9 Mi 16	116		09.87	12.88 + BE1/5-Getriebe 2)					
PEUGEOT 405 (93-95)										
	1.4 i	55		09.92	10.95 - ABS	24.2120-1701.3	010427			Thz 20,64
	1.6	65		09.92	10.95 - ABS					
	1.8 i	74		09.92	10.95 - ABS					
	1.4 i	55		09.92	10.95 + ABS	24.2122-1704.3	010423			Thz 22,20
	1.6	65		09.92	10.95 + ABS					
	1.8 i	74		09.92	10.95 + ABS					
	1.9	93		09.92	12.93 + ABS					
	1.9 D			09.92	10.95 + ABS					
	1.9 TD	66		09.92	10.95 + ABS					
	2.0 16V	144		09.92	10.95 + ABS					
	2.0 i	89		09.92	10.95 + ABS					
	1.8 i	74		09.92	10.95 - ABS	24.3481-1707.5	240073			D=48, - Halter LUC
	1.9 D			09.92	10.95 - ABS	24.3481-1708.5	240074			D=48, - Halter LUC
	1.9 TD	66		09.92	10.95 - ABS	24.0101-3601.2	260044			Bremssattel-Zubehör LUC
	1.8 i	74		09.92	10.95 + ABS	24.0101-3601.2	260044			Bremssattel-Zubehör LUC
	1.9	93		09.92	12.93					
	1.9 D			09.92	10.95 + ABS					
	1.9 TD	66		09.92	10.95 + ABS					
	2.0 16V	144		09.92	10.95					
	2.0 i	89		09.92	10.95					
	2.0 i X4	89		09.92	10.95					
	1.4 i	55		09.92	10.95	13.0460-3911.2	603911			20905 18,0 +/WK BDX
	1.6	65		09.92	10.95	13.0460-0403.2	610403			Belagsatz-Zubehör BDX
	1.6	65		09.92	10.95	13.0460-2971.2	602971			21209 18,5 +/WK/S LUC
	1.8 i	74		09.92	10.95					
	1.9	93		09.92	12.93					
	1.9 D			09.92	10.95					
	1.9 TD	66		09.92	10.95					
	2.0 16V	144		09.92	10.95					
	2.0 i	89		09.92	10.95					
	2.0 i X4	89		09.92	10.95					
	1.4 i	55		09.92	10.95	24.0110-0183.1	410183			266 10,0 8,0
	1.6	65		09.92	10.95					
	1.8 i	74		09.92	10.95	24.0120-0133.1	420133			266 20,5 18,5 V +S +B
	1.9	93		09.92	12.93	24.0320-0133.1	520133			266 20,5 18,5 V +S +B PD
	1.9 D			09.92	10.95					
	1.9 TD	66		09.92	10.95					
	2.0 16V	144		09.92	10.95					
	2.0 i	89		09.92	10.95					
	2.0 i X4	89		09.92	10.95					
	2.0 T16 X4	144		07.93	10.95	24.0122-0142.1	422142			283 22,0 20,0 V L +B
	1.4 i	55		09.92	10.95	24.5118-0420.3	330444	2		L=420
	1.6	65		09.92	10.95					
	1.8 i	74		09.92	10.95					
	1.9	93		09.92	12.93					

1) + BE3/5 transmission / + scatola cambio BE3/5 / + boîte de vitesse BE3/5 / + cambio BE3/5

2) + BE1/5 transmission / + scatola cambio BE1/5 / + boîte de vitesse BE1/5 / + cambio BE1/5

										
PEUGEOT 405 (93-95)										
	1.9 D 1.9 TD 2.0 16V 2.0 i	66 144 89		09.92 09.92 09.92 09.92	10.95 10.95 10.95 10.95	24.5118-0420.3	330444	2	L=420	
	1.9 1.9 TD 2.0 16V 2.0 i	93 66 144 89		09.92 09.92 09.92 09.92	12.93 10.95 + ABS 10.95 10.95	24.3384-1605.5 24.3384-1606.5	240295 240296	 	D=38, - Halter D=38, - Halter	LUC LUC
	1.9 1.9 TD 2.0 16V 2.0 i	93 66 144 89		09.92 09.92 09.92 09.92	12.93 10.95 + ABS 10.95 10.95	13.0460-2842.2 13.0460-0072.2	602842 610072		20961 15,2 /S Belagsatz-Zubehör	LUC LUC
	2.0 i X4 2.0 T16 X4	89 144		09.92 07.93	10.95 10.95	13.0460-2937.2 13.0460-0419.2	602937 610419		20961 15,2 /Zub/S Belagsatz-Zubehör	LUC LUC
	1.9 1.9 TD 2.0 16V 2.0 i	93 66 144 89		09.92 09.92 09.92 09.92	12.93 10.95 + ABS 10.95 10.95	24.0110-0199.1	410199		247 10,0 8,0	
	2.0 i X4 2.0 T16 X4	89 144		09.92 07.93	10.95 10.95	24.0110-0187.1	410187		247 10,0 9,0 +S +B	
	1.4 i 1.6 1.8 i 1.9 D	55 65 74		09.92 09.92 09.92 09.92	10.95 10.95 10.95 10.95	24.5229-0181.3	330533	2	L=180	
	1.9 1.9 TD 2.0 16V 2.0 i	93 66 144 89		09.92 09.92 09.92 09.92	12.93 10.95 10.95 10.95	24.5229-0181.3 24.5111-0235.3	330533 330477	2 2	Länge beachten ¹⁾ Länge beachten ¹⁾	L=180 L=234
	2.0 i X4 2.0 T16 X4	89 144		09.92 07.93	10.95 10.95	24.5111-0235.3	330477	2	L=234	
	1.4 i Lim. 1.6 Lim. 1.8 i Lim. 1.9 D Lim.	55 65 74		09.92 09.92 09.92 09.92	10.95 - ABS 10.95 - ABS 10.95 - ABS 10.95 - ABS	24.3220-1611.3 24.3220-1612.3	020238 020239	 	RzR 20,64 RzR 20,64	BDX BDX
	1.4 i Kombi 1.4 i Kombi 1.4 i Lim. 1.6 Kombi 1.6 Kombi 1.6 Lim. 1.8 i Kombi 1.8 i Kombi 1.8 i Lim. 1.9 D Kombi 1.9 D Kombi 1.9 D Lim.	55 55 S 71211989 55 65 65 S 71211989 65 74 74 S 71211989 74 74 S 71211989 74 S 71211989 66	S 71211989 S 71211989 S 71211989 S 71211989 S 71211989 S 71211989	09.92 09.92 09.92 09.92 09.92 09.92 09.92 09.92 09.92 09.92 09.92	- ABS + ABS (Bendix) + ABS (Bendix) - ABS + ABS (Bendix) + ABS (Bendix) - ABS + ABS (Bendix) + ABS (Bendix) - ABS + ABS (Bendix) + ABS (Bendix)	24.3220-0905.3	020207		Rz 20,64	LUC
	1.4 i Kombi 1.4 i Kombi 1.6 Kombi 1.6 Kombi 1.8 i Kombi 1.8 i Kombi 1.9 D Kombi 1.9 D Kombi 1.9 TD Kombi	55 55 S 71211989 65 65 S 71211989 74 74 S 71211989 74 S 71211989 66	S 71211989 S 71211989 S 71211989 S 71211989 S 71211989 S 71211989	09.92 09.92 09.92 09.92 09.92 09.92 09.92 09.92	+ ABS (Bosch) - ABS + ABS (Bosch) - ABS + ABS (Bosch) - ABS + ABS (Bosch) - ABS	24.3220-1715.3	020412		Rz 20,64	LUC
	1.4 i Lim. 1.6 Lim. 1.8 i Lim. 1.9 D Lim.	55 65 74	S 71407666 S 71407666 S 71407666 S 71407666	09.92 09.92 09.92 09.92	- ABS - ABS - ABS - ABS	03.0137-0202.2 03.0137-9089.2	650202 669089		229 x 42 Bremsbacken-Zubehör	BDX BDX
	1.4 i Lim. 1.6 Lim. 1.8 i Lim. 1.9 D Lim.	55 65 74	S 71407667 S 71407667 S 71407667 S 71407667	10.95 10.95 10.95 10.95	- ABS - ABS - ABS - ABS	03.0137-0202.2 03.0137-9228.2	650202 669228		229 x 42 Bremsbacken-Zubehör	BDX BDX
	1.4 i Kombi 1.4 i Kombi 1.4 i Lim. 1.6 Kombi 1.6 Kombi 1.6 Lim. 1.8 i Kombi 1.8 i Kombi 1.8 i Lim. 1.9 D Kombi 1.9 D Kombi 1.9 D Lim.	55 55 S 71211989 55 65 65 S 71211989 65 74 74 S 71211989 74 74 S 71211989 74 S 71211989 66	S 71211989 S 71211989 S 71211989 S 71211989 S 71211989 S 71211989	09.92 09.92 09.92 09.92 09.92 09.92 09.92 09.92 09.92 09.92 09.92	- ABS + ABS (Bendix) + ABS (Bendix) - ABS + ABS (Bendix) + ABS (Bendix) - ABS + ABS (Bendix) + ABS (Bendix) - ABS + ABS (Bendix) + ABS (Bendix)	03.0137-0271.2 03.0137-9027.2	650271 669027		229 x 42 HEB Bremsbacken-Zubehör	LUC LUC
	1.4 i Kombi 1.4 i Kombi 1.6 Kombi 1.6 Kombi 1.8 i Kombi 1.8 i Kombi 1.9 D Kombi 1.9 D Kombi 1.9 TD Kombi	55 55 S 71211989 65 65 S 71211989 74 74 S 71211989 74 S 71211989 66	S 71211989 S 71211989 S 71211989 S 71211989 S 71211989 S 71211989	09.92 09.92 09.92 09.92 09.92 09.92 09.92 09.92	+ ABS (Bosch) - ABS + ABS (Bosch) - ABS + ABS (Bosch) - ABS + ABS (Bosch) - ABS	03.0137-0347.2 03.0137-9220.2	650347 669220		229 x 42 HEB Bremsbacken-Zubehör	LUC LUC

¹⁾ notice length / attenzione lunghezza / faire attention longueur / atención largo

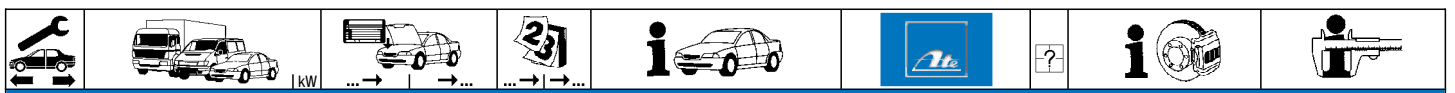

PEUGEOT 405 (93-95)























	1.4 i 1.6 1.8 i 1.9 D 1.9 TD	55 65 74 66		09.92 09.92 09.92 09.92 09.92	10.95 10.95 10.95 10.95 10.95	24.0222-8017.1	480071		229/230 x 50,8
	1.4 i Lim. 1.6 Lim. 1.8 i Lim. 1.9 D Lim.	55 S 71407667 65 S 71407667 74 S 71407667 S 71407667			10.95 - ABS 10.95 - ABS 10.95 - ABS 10.95 - ABS	03.0520-1220.3	691220		20,64/229x42 TopKit BDX
	1.4 i Kombi 1.4 i Kombi 1.4 i Lim. 1.6 Kombi 1.6 Kombi 1.6 Lim. 1.8 i Kombi 1.8 i Kombi 1.8 i Lim. 1.9 D Kombi 1.9 D Kombi 1.9 D Lim.	55 55 S 71211989 55 65 65 S 71211989 65 74 74 S 71211989 74 S 71211989 S 71211989	S 71211989 S 71211989 S 71211989 S 71211989	09.92 09.92 09.92 09.92 09.92 09.92 09.92 09.92 09.92 09.92 09.92	- ABS + ABS (Bendix) + ABS (Bendix) - ABS + ABS (Bendix) + ABS (Bendix) - ABS + ABS (Bendix) + ABS (Bendix) - ABS + ABS (Bendix) + ABS (Bendix)	03.0520-4120.3	694120		20,64/229x42 TopKit LUC
	1.4 i Kombi 1.4 i Kombi 1.6 Kombi 1.6 Kombi 1.8 i Kombi 1.8 i Kombi 1.9 D Kombi 1.9 D Kombi 1.9 TD Kombi	55 55 S 71211989 65 65 S 71211989 74 74 S 71211989 S 71211989 66		09.92 09.92 09.92 09.92 09.92 09.92 09.92 09.92	+ ABS (Bosch) - ABS + ABS (Bosch) - ABS + ABS (Bosch) - ABS + ABS (Bosch) - ABS - ABS	03.0520-5420.3	695420		20,64/229x42 TopKit LUC
	1.4 i 1.6 1.8 i 1.9 D 1.9 TD 1.9 1.9 TD 2.0 16V 2.0 i	55 65 74 66 93 66 144 89		09.92 09.92 09.92 09.92 09.92 09.92 09.92 09.92 09.92	10.95 10.95 10.95 10.95 10.95 + HA-Trommelbremse 1) 12.93 10.95 + HA-Scheibenbremse 2) 10.95 10.95	24.3727-0831.2 24.3727-0804.2 24.3727-0803.2	580831 580804 580803	1 <input type="checkbox"/> <input type="checkbox"/>	L=1842 L=855 L=550
	1.4 i 1.6 1.8 i 1.9 1.9 D 1.9 TD 2.0 16V 2.0 i	55 65 74 93 66 144 89		09.92 09.92 09.92 09.92 09.92 09.92 09.92	10.95 10.95 10.95 12.93 10.95 10.95 10.95	03.6583-0037.3	320107		BRL 8/3 (4) ATE
	1.6 1.8 i 1.9 1.9 D 2.0 i	65 74 93 89		09.92 09.92 09.92 09.92 09.92	10.95 10.95 12.93 10.95 10.95	24.3728-0843.2	590843		L=1443, + AUT

PEUGEOT 504 (68-89)

















	1.8 Kombi 1.8 Lim. 1.9 D Lim. 2.0 Kombi 2.0 Lim. 2.0 Ti 2.1 D Kombi 2.1 D Lim. 2.3 D Kombi 2.3 D Lim.	3.597.843 3.597.843 3.597.843 3.597.843 3.597.843 3.597.843 3.597.843 3.597.843 3.597.843 3.597.843	3.624.586 3.624.586 3.624.586		06.83 07.86 06.83 06.83 07.86 12.83	03.2120-1122.3	010084		Thz 20,64 ATE
	1.6 Pick up 1.8 1.8 Pick-up 1.9 D 2.0 2.0 Ti 2.1 D 2.3 D 2.7 V6 Cabrio 2.7 V6 Coupe	2.782.006 2.782.006 2.782.006 2.782.006 2.782.006 2.782.006 2.782.006		10.81 10.81	06.87 07.86 + (N) (S) (FR) 12.89 12.89 + (N) (S) (FR) 07.86 + (N) (S) (FR) 06.83 + (N) (S) (FR) 07.86 + (N) (S) (FR) 12.89 + (N) (S) (FR)	11.0441-5401.2	250027		Dichtungssatz ATE
	1.6 Pick up 1.8 1.9 D 2.0 2.0 Ti 2.1 D 2.3 D			09.74 09.74	08.84 08.84	11.0441-5401.2	250027		Dichtungssatz ATE
	1.6 Pick up 1.8 1.9 D 2.0 2.0 Ti 2.1 D 2.3 D			10.79 07.68 03.73 03.71 01.71 02.71 07.75	06.87 12.89 12.89 07.86 06.83 07.86 12.89	24.0113-0128.1	413128		273 13,0 10,7
	1.6 Pick up 1.8 Cabrio 1.8 Coupe 1.8 Kombi 1.8 Lim.	2.058.001 2.058.001		10.81 09.77 09.77	06.87 08.84 08.84 07.86 06.83	24.5112-0381.3	330711	2	L=380

























1) + RA drum brake / + P freno a tamburo / + frein à tambour essieu AR / + ET-tambores de freno
2) + RA disc brake / + P disco freno / + frein à disque essieu AR / + ET-disco de freno



									
PEUGEOT 504 (68-89)									
	1.8 Pick-up 1.9 D Lim. 2.0 Cabrio 2.0 Coupe 2.0 Kombi 2.0 Lim. 2.1 D Kombi 2.1 D Lim. 2.3 D Kombi 2.3 D Lim. 2.7 V6 Cabrio 2.7 V6 Coupe	2.058.001 2.058.001 2.058.001 2.058.001 2.058.001 2.058.001 2.058.001 2.058.001 2.058.001 2.058.001	11.81 09.77 09.77 07.86 06.86 07.86 07.86 07.86 07.86 12.83 09.77 09.77	12.89 07.86 08.84 08.84 07.86 06.86 07.86 07.86 07.86 12.83 08.84 08.84	24.5112-0381.3	330711	2	L=380	
	1.6 Pick up		09.78	08.81	24.2730-1101.3	020339	4	Rz 30,00	
	1.8 Cabrio 1.8 Coupe 1.8 GL 1.9 D Lim. 2.0 Cabrio 2.0 Coupe 2.0 GL 2.0 Ti 2.1 D Lim. 2.3 D Lim. 2.7 V6 Cabrio 2.7 V6 Coupe	2.058.001 2.058.001 2.058.001 2.058.001 2.058.001 2.058.001 2.058.001 2.058.001 2.058.001 2.058.001 2.058.001 2.058.001	08.84 08.84 06.83 08.79 07.86 08.84 08.84 06.86 10.77 06.83 08.79 07.86 08.79 12.83 09.74 12.84 09.74 12.84	08.84 08.84 06.83 07.86 08.84 08.84 06.86 06.83 07.86 12.83 12.84 12.84	24.5228-0216.3	330908	2	L=216	
	1.8 Lim. 1.6 Pick up 1.8 Pick-up		09.77 09.81 09.81	06.83 06.87 12.89	24.3222-1106.3 24.3222-1107.3 24.3222-1615.3	020261 020262 020285	 	Rz 22,20 Rz 22,20 Rz 22,20	LUC LUC
	1.6 Pick up 1.8 Lim. 2.1 D Kastenw.		09.80 09.77 09.80	08.81 06.83 08.81	03.0137-9082.2	669082		Bremsbacken-Zubehör	LUC
	1.8 1.8 GL 1.8 Pick-up 1.9 D Lim. 2.0 Cabrio 2.0 Coupe 2.0 GL 2.0 Ti 2.1 D Lim. 2.3 D Lim. 2.7 V6 Cabrio 2.7 V6 Coupe	2.058.001 2.058.001 2.058.001 2.058.001 2.058.001 2.058.001 2.058.001 2.058.001 2.058.001 2.058.001 2.058.001 2.058.001	10.77 10.77 10.77 10.77 10.77 09.77 06.83 07.86 12.83 09.74 09.74	08.84 09.77 08.84 07.86 08.84 08.84 09.77 06.83 07.86 12.83 08.84 08.84	+ VA-Scheibenbremse 1) + VA-Scheibenbremse 1)	03.6515-1000.3	320089	BRL 1/5 (3)	ATE
	1.8 Kombi 1.8 L/GR/SR 2.0 Kombi 2.0 L/GR/SR 2.1 D Kombi 2.3 D Kombi	2.058.001 2.058.001 2.058.001 2.058.001 2.058.001 2.058.001	07.86 06.83 07.86 06.86 07.86 07.86	07.86 06.83 07.86 06.86 07.86 07.86	03.6515-0600.3	320088		BRL 1/5 (2)	ATE
	1.8 1.9 D 2.0 2.0 Ti 2.1 D 2.3 D 2.7 V6	1.974.191 1.974.191 1.974.191 1.974.191 1.974.191 1.974.191 1.974.191	12.89 12.89 07.86 06.83 07.86 12.89 09.74	12.89 12.89 07.86 06.83 07.86 12.89 08.84	24.2419-0929.3	030057		Gz 19,05	
	1.8 1.9 D 2.0 2.0 Ti 2.1 D 2.3 D 2.7 V6	3.650.193 1.974.191 3.650.193 3.650.193 1.974.191 1.974.191 3.650.193	12.89 12.89 07.86 06.83 07.86 12.89 08.84	12.89 12.89 07.86 06.83 07.86 12.89 08.84	24.2528-1601.3	040063		Nz 28,57	
PEUGEOT 505 (79-93)									
	1.8 2.0 Lim. 2.0 Ti/STi 2.2 GTi Lim. 2.2 i Lim. 2.2 Ti 2.3 TD 2.5 D Lim. 2.5 TD Lim. 2.8 V6		01.82 11.80 08.79 08.83 05.81 03.84 09.80 06.81 10.83 06.86	10.86 10.86 10.86 12.93 12.93 10.88 06.86 12.93 12.93 12.93	03.2120-1122.3	010084		THz 20,64	ATE
	1.8 2.0 2.0 Ti/STi 2.2 GTi 2.2 i 2.3 TD 2.5 D 2.5 TD		01.82 11.80 08.79 08.83 05.81 09.80 06.81 10.83	10.86 11.87 10.86 12.93 12.93 06.86 12.93 12.93	11.0441-5401.2	250027		Dichtungssatz	ATE

1) + FA disc brake / + A disco freno / + frein à disque essieu AV / + ED disco de freno

								
PEUGEOT 505 (79-93)								
	2.2 Ti 2.8 V6			03.84 06.86	10.88 12.93	11.0441-5401.2	250027	Dichtungssatz ATE
	1.8 2.0 2.0 Ti/STi 2.2 GTi 2.2 i 2.3 TD 2.5 D 2.5 TD			01.82 11.80 08.79 08.83 05.81 09.80 06.81 10.83	10.86 11.87 10.86 12.93 12.93 06.86 12.93 12.93	24.0113-0128.1	413128	273 13,0 10,7
	1.8 2.0 2.0 Ti/STi 2.2 GTi 2.2 i 2.2 Ti 2.3 TD 2.5 D 2.5 TD 2.8 V6			01.82 11.80 08.79 08.83 05.81 03.84 09.80 06.81 10.83 06.86	10.86 11.87 10.86 12.93 12.93 10.88 06.86 12.93 12.93 12.93	24.5112-0381.3	330711 2	L=380
	1.8 2.0 Lim. 2.0 Ti/STi 2.2 GTi Lim. 2.2 i Lim. 2.2 Ti 2.3 TD 2.5 D Lim. 2.5 TD Lim. 2.8 V6			01.82 11.80 08.79 08.83 05.81 03.84 09.80 06.81 10.83 06.86	10.86 10.86 10.86 12.93 12.93 10.88 06.86 12.93 12.93 12.93	24.5228-0216.3	330908 2	L=216
	2.0 Lim. 2.0 Ti/STi 2.2 i Lim. 2.3 TD 2.5 D Lim.		1.214.334 1.214.334 1.214.334 1.214.334 1.214.334	11.80 08.79 05.81 09.80 06.81		24.3222-1106.3 24.3222-1107.3	020261 020262	Rz 22,20 Rz 22,20 LUC
	1.8 2.0 Lim. 2.0 Ti/STi 2.2 i Lim. 2.3 TD 2.5 D Lim. 2.5 TD Lim.	1.214.335 1.214.335 1.214.335 1.214.335 1.214.335		01.82 10.86 10.86 12.93 06.86 12.93 10.83	10.86 10.86 10.86 12.93 06.86 12.93 12.93	24.3220-1619.3	020246	Rz 20,64 LUC
	2.0 Kombi 2.2 i Kombi 2.5 D Kombi 2.5 TD Kombi			04.82 01.86 08.83 10.85	11.87 12.93 12.93 12.93	24.3222-1615.3	020285	Rz 22,20 LUC
	2.0 Ti/STi 1.8 2.0 Lim. 2.0 Ti/STi 2.2 i Lim. 2.3 TD 2.5 D Lim. 2.5 TD Lim.	1.132.382	1.132.381	08.79 01.82 11.80 05.81 09.80 06.81 10.83	10.86 10.86 10.86 12.93 06.86 12.93 12.93	03.0137-9082.2	669082	Bremsbacken-Zubehör LUC
	2.0 Kombi 2.2 i Kombi 2.5 D Kombi 2.5 TD Kombi			04.82 01.86 08.83 10.85	11.87 12.93 12.93 12.93	03.0137-9082.2	669082	Bremsbacken-Zubehör LUC
	1.8 2.0 Lim. 2.0 Ti/STi 2.2 GTi Lim. 2.2 i Lim. 2.2 Ti 2.3 TD 2.5 D Lim. 2.5 TD Lim. 2.8 V6			01.82 11.80 08.79 08.83 05.81 03.84 09.80 06.81 10.83 06.86	10.86 10.86 10.86 12.93 12.93 10.88 06.86 12.93 12.93 12.93	03.6515-1000.3	320089	BRL 1/5 (3) ATE
	2.0 Kombi 2.2 GTi Kombi 2.2 i Kombi 2.5 D Kombi 2.5 TD Kombi			04.82 09.85 01.86 08.83 10.85	11.87 12.86 12.93 12.93 12.93	03.6515-0600.3	320088	BRL 1/5 (2) ATE
	1.8 2.0 2.0 Ti/STi 2.2 GTi 2.2 i 2.2 Ti 2.3 TD 2.5 D 2.5 TD 2.8 V6			01.82 11.80 08.79 08.83 05.81 03.84 09.80 06.81 10.83 06.86	10.86 11.87 10.86 12.93 12.93 10.88 06.86 12.93 12.93 12.93	24.2419-0929.3	030057	Gz 19,05

																			
PEUGEOT 505 (79-93)																			
	1.8			01.82	10.86			24.2528-1601.3	040063									Nz 28,57	
	2.0			11.80	11.87														
	2.0 Ti/STi			08.79	10.86														
	2.2 GTi			08.83	12.93														
	2.2 i			05.81	12.93														
	2.2 Ti			03.84	10.88														
	2.3 TD			09.80	06.86														
	2.5 D			06.81	12.93														
	1.8			01.82	10.86			24.5228-0216.3	330908									L=216	
	2.0 Kombi			04.82	11.87														
	2.0 Lim.			11.80	10.86														
	2.0 Ti/STi			08.79	10.86														
	2.2 GTi Kombi			09.85	12.86														
	2.2 GTi Lim.			08.83	12.93														
	2.2 i Kombi			01.86	12.93														
	2.2 i Lim.			05.81	12.93														
	2.2 Ti			03.84	10.88														
	2.3 TD			09.80	06.86														
	2.5 D Kombi			08.83	12.93														
	2.5 D Lim.			06.81	12.93														
	2.5 TD Kombi			10.85	12.93														
	2.5 TD Lim.			10.83	12.93														
	2.8 V6			06.86	12.93														
	2.3 TD		1.292.000	09.80				24.5112-0381.3	330711									L=380	
	2.5 D Lim.		1.292.000	06.81															
PEUGEOT 604 (75-86)																			
	2.0	70		03.83	02.87			11.0441-5401.2	250027									Dichtungssatz	ATE
	2.3 TD	59		10.78	10.83														
	2.5 TD	66		10.83	10.86														
	2.7 V6	100		09.75	10.84			11.0441-5401.2	250027									Dichtungssatz	ATE
	2.7 V6	106		10.77	10.83														
	2.8 V6	110		10.83	10.86														
	2.0	70		03.83	02.87			24.0113-0128.1	413128									273 13,0 10,7	
	2.3 TD	59		10.78	10.83														
	2.5 TD	66		10.83	10.86														
	2.0	70		03.83	02.87			24.5112-0381.3	330711	2								L=380	
	2.3 TD	59		10.78	10.83														
	2.5 TD	66		10.83	10.86														
	2.7 V6	100		09.75	10.84														
	2.7 V6	106		10.77	10.83														
	2.8 V6	110		10.83	10.86														
	2.0	70		03.83	02.87			24.5228-0216.3	330908	2								L=216	
	2.3 TD	59		10.78	10.83														
	2.5 TD	66		10.83	10.86														
	2.7 V6	100		09.75	10.84														
	2.7 V6	106		10.77	10.83														
	2.8 V6	110		10.83	10.86														
	2.0	70		03.83	02.87			24.2419-0929.3	030057									Gz 19,05	
	2.3 TD	59		10.78	10.83														
	2.5 TD	66		10.83	10.86														
	2.7 V6	100		09.75	10.84														
	2.7 V6	106		10.77	10.83														
	2.8 V6	110		10.83	10.86														
	2.0	70		03.83	02.87			24.2528-1601.3	040063									Nz 28,57	
	2.3 TD	59		10.78	10.83														
	2.5 TD	66		10.83	10.86														
	2.7 V6	106		10.77	10.83			24.5228-0216.3	330908									L=216	
	2.8 V6	110		10.83	10.86														
POL MOT 125 (67-74)																			
	alle Typen			09.67	08.74			24.2119-0806.3	010345									THz 19,05	
POL MOT 126 (72-90)																			
	alle Typen			01.79	07.90			24.2119-0815.3	010347									THz 19,05	
	alle Typen			04.72	12.78			24.3223-0801.3	020316									Rz 23,81	
	alle Typen			01.79	07.90			24.3223-0802.3	020286									Rz 23,81	FI
	alle Typen			04.72	07.90			03.0137-0015.2	650015									185 x 31 AUT	FI
								03.0137-9021.2	669021									Bremsbacken-Zubehör	FI
	alle Typen			04.72	12.78			24.3215-0802.3	020308									Rz 15,87	FI
	alle Typen			01.79	07.90			24.3219-0801.3	020181									Rz 19,05	FI
	alle Typen			04.72	07.90			03.0137-0015.2	650015									185 x 31 AUT	FI
								03.0137-9021.2	669021									Bremsbacken-Zubehör	FI

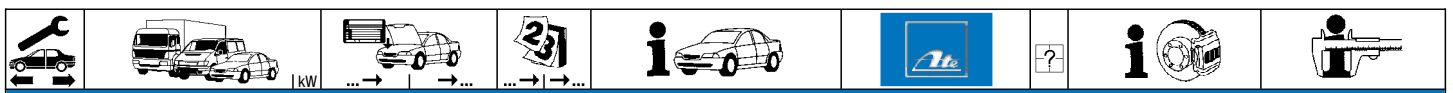

PORSCHE 356 (51-65)											
	356 1.1/1.3/1.5			01.51	12.53		03.3119-0201.3	010257		Hz 19,05	ATE
	356 A 1.3/1.5			01.54	12.59		03.3119-0211.3	010258		Hz 19,05 + Behälter	ATE
	356 B 1.6			01.60	12.62						
	502 Super 1.5			01.52	12.53						
	550 Spyder 1.5			01.55	12.56						
	1600			01.63	12.65		03.3119-6551.3	010270		Hz 19,05	ATE
	1600 C/SC			01.63	12.65						
	1600 Super 90			01.63	12.65						
	1600 C/SC			01.63	12.65		13.0441-4801.2	250100		Dichtungssatz	ATE
	1600 Super 90			01.63	12.65						
	356 1.1/1.3/1.5			01.60	12.65						
	356 A 1.3/1.5			01.61	12.64						
	356 A 1.5			01.61	12.64						
	356 B 1.6			01.61	12.64						
	B 2000 GS Carrera			01.61	12.64						
	C 2000 GS Carrera			01.61	12.64						
	1600			01.55	12.65		24.5165-0350.3	331257	2	L=350	
	1600 C/SC			01.63	12.65						
	1600 Super 90			01.63	12.65						
	356 A 1.3/1.5			01.56	12.65						
	356 B 1.6			01.60	12.65						
	1500 S			01.50	12.59		03.2719-0209.3	020002	2	links oben + rechts unten ¹⁾ rechts oben + links unten ²⁾	Rz 19,05
	356 A 1.3/1.5			01.50	12.59		03.2719-0309.3	020003	2		Rz 19,05
	356 B 1.6			01.60	12.63						
	550 Spyder 1.5			01.50	12.59						
	1600 C/SC			01.63	12.65		13.0441-3502.2	250049		Dichtungssatz	ATE
	1600 Super 90			01.63	12.65						
	356 1.1/1.3/1.5			01.60	12.65						
	356 A 1.3/1.5			01.61	12.64						
	356 A 1.5			01.61	12.64						
	356 B 1.6			01.61	12.64						
	B 2000 GS Carrera			01.61	12.64						
	C 2000 GS Carrera			01.61	12.64						
	356 A 1.3/1.5			01.55	12.59		83.6101-0520.3	330215	2	L=520	
	1600			01.63	12.65		83.6101-0240.3	330202	2	L=240	
	1600 C/SC			01.63	12.65						
	1600 Super 90			01.63	12.65						
	356 B 1.6			01.60	12.62						
	1600 C/SC			01.60	12.65		03.3219-0102.3	020036		Rz 19,05	
	1600 GT			01.60	12.65		03.0470-2619.2	060051		Rz Dichtungssatz	
	1600 Super 90			01.60	12.65						
	356 1.1/1.3/1.5	G 18 605		01.51	12.53						
	356 A 1.3/1.5	G 18 605			12.59						
	356 A 1.5				12.59						
	356 B 1.6			01.60	12.65						
	502 Super 1.5			01.52	12.53						
	550 Spyder 1.5			01.55	12.56						
	B 2000 GS Carrera			01.60	12.65						
	C 2000 GS Carrera			01.60	12.65						

PORSCHE 911 (63-90)											
	911			01.64	12.67		03.3119-7251.3	010272		Hz 19,05	ATE
	912			01.64	12.67						
	911			01.68	12.75		03.2119-2301.3	010055		THz 19,05	ATE
	912			01.68	12.69		03.2119-0881.3	010053		THz 19,05 + WE	ATE
	911			01.76	12.77		03.2119-0881.3	010053		THz 19,05 + WE	ATE
	911 Carrera 3.0			01.74	12.77						
	911 S			01.74	12.77						
	911 Cabrio			01.84	12.89		03.2120-2462.3	010113		THz 20,64 + WE	ATE
	911 Coupe			01.84	12.89						
	911 SC			01.78	12.83						
	911 Targa			01.78	12.89						
	911 Turbo Look Coupe			01.84	12.89		03.2123-0162.3	010162		THz 23,81 + WE	ATE
	911			01.69	12.75		13.2481-9999.2	210103	<input type="checkbox"/> Flanschmaß=76,2 ³⁾	D=48	ATE
	911 S			01.74	12.75		13.2481-9998.2	210102	<input type="checkbox"/> Flanschmaß=76,2 ³⁾	D=48	ATE
	911 T			01.69	12.70		13.0441-4815.2	250102		Dichtungssatz	ATE
	911 USA			01.69	12.70						
	911			01.76	12.77		13.2481-8067.2	210098	<input type="checkbox"/>	D=48	ATE
	911 Carrera 3.0			01.74	12.77		13.2481-8068.2	210099	<input type="checkbox"/>	D=48	ATE
	911 E/S			01.69	12.76		13.0441-4819.2	250104	<input type="checkbox"/> + GG-Sättel ⁴⁾	Dichtungssatz	ATE
	911 S			01.76	12.77		13.0441-4806.2	250101	<input type="checkbox"/> + ALU-Sättel ⁵⁾	Dichtungssatz	ATE
	911 SC			01.78	12.83						
	911 Targa			01.78	12.83						
	911 Cabrio			01.84	12.89		13.2481-0075.2	210081	<input type="checkbox"/>	D=48	ATE
	911 Carrera			01.84	12.89		13.2481-0076.2	210082	<input type="checkbox"/>	D=48	ATE
	911 Coupe			01.84	12.89		13.0441-4819.2	250104		Dichtungssatz	ATE
	911 Targa			01.84	12.89						
	911 Turbo Look Coupe			01.84	12.89						
	911			01.74	12.75		13.0462-4855.2	600018		für M-Sättel ⁶⁾	20910 15,0 /WE
	911 S			01.74	12.77						
	911			01.76	12.77		13.0460-4048.2	604048			20011 15,0 /WE
	911 Carrera 3.0			01.74	12.77						

¹⁾ upper left and lower right / sinistra alto e destra basso / gauche, en haut + droite, en bas / izquierda arriba+derecha abajo

²⁾ upper right and lower left / destra alto e sinistra basso / droite, en haut+gauche, en bas / derecha arriba+izquierda abajo

³⁾ flange dimension=76,2 / misura flangia=76,2 / dimension de la bride=76,2 / medida de brida=76,2

⁴⁾ + cast iron caliper / + pinza in ghisa / + étriers en fonte grise / + fundición gris-pinza

⁵⁾ + aluminium calipers / + pinze in alluminio / + étriers en aluminium / + pinzas de aluminio

⁶⁾ for M caliper / per pinze M / pour étrier M / para pinza de M



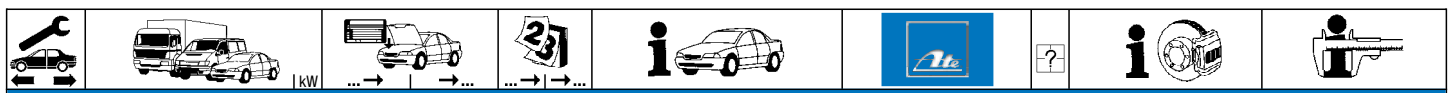































PORSCHE 911 (63-90)

	911 SC		01.78	12.83	13.0460-4048.2	604048		20011 15,0 /WE	ATE
	911 Targa		01.78	12.83					
	911 Cabrio		01.84	12.89	13.0460-4048.2	604048	2	20011 15,0 /WE Warnkontakt L=276mm	ATE
	911 Carrera		01.84	12.89	24.8190-0927.2	620927			
	911 Coupe		01.84	12.89					
	911 Turbo Look Coupe		01.84	12.89					
911 Turbo		01.78	12.89	24.8190-0904.2	620904	2	Warnkontakt L=275mm		
	911		01.69	12.77	24.0120-0103.1	420103		283 20,5 19,1 V L	
	911 Carrera 3.0		01.74	12.77					
	911 S		01.74	12.77					
	911 Carrera 3.2		08.83	12.89	24.0124-0189.1	424189		283 24,0 22,6 V L	
	911 Turbo 3.3		01.81	12.90	24.0132-0140.1	432140	☐ ☐	304 32,0 30,6 V L +B	
				24.0132-0146.1	432146			304 32,0 30,6 V L +B	
	911		01.74	12.77	24.5225-0300.3	331266	2	L=300	
	911 Cabrio		01.84	12.89					
	911 Carrera		01.84	12.89					
	911 Carrera 3.0		01.74	12.77					
	911 Coupe		01.84	12.89					
	911 S		01.74	12.77					
	911 SC		01.78	12.83					
	911 Targa		01.78	12.89					
	911 Turbo		01.78	12.89					
	911 Turbo Look Coupe		01.84	12.89					
	911		01.69	12.77	13.0441-3805.2	250061		Dichtungssatz	ATE
	911 E/S		01.69	12.77					
	911 S		01.69	12.77					
	911 T		01.69	12.77					
	911 USA		01.69	12.77					
	911		01.74	12.77	13.2381-9996.2	210039	☐ ☐	D=38	ATE
	911 Carrera 3.0		01.74	12.77	13.2381-9997.2	210040		D=38	ATE
	911 S		01.74	12.77	13.0441-3801.2	250058		Dichtungssatz	ATE
	911 SC		01.78	12.83					
	911 Targa		01.78	12.83					
	911 Cabrio		01.84	12.89	13.2421-0026.2	210146	☐ ☐	D=42	ATE
	911 Carrera		01.84	12.89	13.2421-0025.2	210145		D=42	ATE
	911 Coupe		01.84	12.89	13.0441-4206.2	250087		Dichtungssatz	ATE
	911 Turbo Look Coupe		01.84	12.89					
912		01.65	12.68	13.0441-3502.2	250049		Dichtungssatz	ATE	
	911		01.74	12.74	13.0462-4855.2	600018		20910 15,0 /WE	ATE
	911 Carrera 3.0		01.74	12.74	13.0460-0192.2	610192		Belagsatz-Zubehör	ATE
	911 S		01.74	12.74					
	911 Cabrio		01.84	12.89	13.0462-4855.2	600018	2	20910 15,0 /WE Belagsatz-Zubehör Warnkontakt L=275mm	ATE
	911 Carrera		01.84	12.89	13.0460-0193.2	610193			
	911 Coupe		01.84	12.89	24.8190-0904.2	620904			
911 Targa		01.78	12.89						
911 Turbo Look Coupe		01.84	12.89						
	911		01.74	12.83	24.0120-0185.1	420185		290 20,0 18,7 V L	
	911 Carrera 3.0		01.74	12.83					
	911 S		01.74	12.77					
	911 SC		01.78	12.83					
	911 Targa		01.78	12.83					
	911 Carrera 3.2		08.83	12.89	24.0124-0190.1	424190		290 24,0 22,6 V L	
	911 Turbo 3.3		01.87	12.90	24.0128-0171.1	428171	☐ ☐	309 28,0 26,0 V L +B	
				24.0128-0172.1	428172			309 28,0 26,0 V L +B	
	911		01.64	12.69	83.6101-0240.3	330202	2	L=240	
	911 E/S		01.64	12.69					
	911 S		01.66	12.68					
	911		01.74	12.77	24.5225-0240.3	331321			
	911 Carrera 3.0		01.74	12.77					
	911 E/S		01.64	12.69					
	911 S		01.74	12.77					
	911 SC		01.78	12.83					
	911 Targa		01.78	12.83					
	911 Turbo		01.78	12.83					
	911 USA		01.70	12.77					
911 Cabrio		01.84	12.89	83.6205-0252.3	330315	2	L=250		
911 Carrera		01.84	12.89						
911 Coupe		01.84	12.89						
911 Targa		01.84	12.89						
911 Turbo		01.84	12.89						
911 Turbo Look Coupe		01.84	12.89						
	911 Cabrio		01.87	12.89	24.2523-0909.3	040050		Nz 23,81	
	911 Carrera		01.87	12.89					
	911 Coupe		01.87	12.89					
	911 Targa		01.87	12.89					
	911 Turbo Look Coupe		01.87	12.89					

PORSCHE 911 (964) (88-93)

	3.3 TURBO	235	08.90	09.93	24.8190-0917.2	620917	2	Warnkontakt L=518mm	
	3.6 CARRERA RS	191	06.91	09.93					
	3.6 CARRERA	184	07.89	09.93	24.8190-0917.2	620917			
	3.6 CARRERA 4	184	12.88	09.93					
	3.6 TURBO	265	01.93	09.93	13.0460-4056.2	604056			
				24.8190-0926.2	620926	2	21402 17,5 /WE	BRE	
								Warnkontakt L=475mm	

								
PORSCHE 911 (964) (88-93)								
	3.6 CARRERA 3.6 CARRERA 4	184 184		07.89 12.88	09.93 09.93	24.0128-0174.1	428174	298 28,0 26,0 V L
	3.6 CARRERA 3.6 CARRERA 4 3.6 CARRERA RS	184 184 191		07.89 12.88 06.91	09.93 09.93 09.93	83.6220-0296.3	330324	L=295
	3.3 TURBO 3.3 TURBO 3.6 CARRERA 4 3.6 CARRERA RS 3.6 TURBO 3.6 CARRERA	235 235 184 191 265 184		08.90 01.92 12.88 06.91 01.93 07.89	12.91 09.93 09.93 09.93 09.93 09.93	24.8190-0918.2	620918	Warnkontakt L=440mm
	3.6 CARRERA 3.6 CARRERA 4	184 184		07.89 12.88	09.93 09.93	24.0124-0117.1	424117	21163 14,5 /WE Warnkontakt L=440mm
	3.3 TURBO 3.3 TURBO S 3.6 CARRERA 3.6 CARRERA 4 3.6 CARRERA RS 3.6 TURBO	235 261 184 184 191 265		08.90 06.91 07.89 12.88 06.91 01.93	09.93 12.92 09.93 09.93 09.93 09.93	83.6205-0252.3	330315	L=250
	3.3 TURBO 3.3 TURBO S 3.6 CARRERA 3.6 CARRERA 4 3.6 CARRERA RS 3.6 TURBO	235 261 184 184 191 265		08.90 06.91 07.89 12.88 06.91 01.93	09.93 12.92 09.93 09.93 09.93 09.93	03.0137-3002.2	653002	180 x 25
PORSCHE 911 CABRIO (964) (89-94)								
	3.6 CARRERA 3.6 CARRERA 4	184 184		07.89 05.89	05.94 05.94	24.8190-0917.2	620917	Warnkontakt L=518mm
	3.6 CARRERA 3.6 CARRERA 4	184 184		07.89 05.89	05.94 05.94	24.0128-0174.1	428174	298 28,0 26,0 V L
	3.6 CARRERA 3.6 CARRERA 4	184 184		07.89 05.89	05.94 05.94	83.6220-0296.3	330324	L=295
	3.6 CARRERA 3.6 CARRERA 4	184 184		07.89 05.89	05.94 05.94	13.0460-4070.2 24.8190-0918.2	604070 620918	21163 14,5 /WE Warnkontakt L=440mm
	3.6 CARRERA 3.6 CARRERA 4	184 184		07.89 05.89	05.94 05.94	24.0124-0117.1	424117	299 24,0 22,0 V L
	3.6 CARRERA 3.6 CARRERA 4	184 184		07.89 05.89	05.94 05.94	83.6205-0252.3	330315	L=250
	3.6 CARRERA 3.6 CARRERA 4	184 184		07.89 05.89	05.94 05.94	03.0137-3002.2	653002	180 x 25
PORSCHE 912 TARGA (65-70)								
	1.6 1.6	66 66		01.65 01.68	12.67 12.69	03.3119-7251.3 03.2119-2301.3 03.2119-0881.3	010272 010055 010053	Hz 19,05 THz 19,05 THz 19,05 + WE
	1.6	66		01.65	12.69	24.5225-0300.3	331266	L=300
	1.6 1.6	66 66		01.65 01.69	12.68 12.69	83.6101-0240.3 24.5225-0240.3	330202 331321	L=240 L=240
PORSCHE 912 (65-69)								
	912 1.6 912 1.6	66 66		01.65 01.68	12.67 12.69	03.3119-7251.3 03.2119-2301.3 03.2119-0881.3	010272 010055 010053	Hz 19,05 THz 19,05 THz 19,05 + WE
	912 1.6 912 USA	66 66		01.65 01.64	12.68 12.68	13.0441-4815.2	250102	Dichtungssatz
	912 1.6 912 USA	66 66		01.64 01.67	12.69 12.69	24.5225-0300.3	331266	L=300
	912 1.6 912 USA	66 66		01.69 01.69	12.69 12.69	13.0441-3805.2	250061	Dichtungssatz
	912 1.6 912 1.6 912 USA	66 66 66		01.65 01.69 01.69	12.68 12.69 12.69	83.6101-0240.3 24.5225-0240.3	330202 331321	L=240 L=240

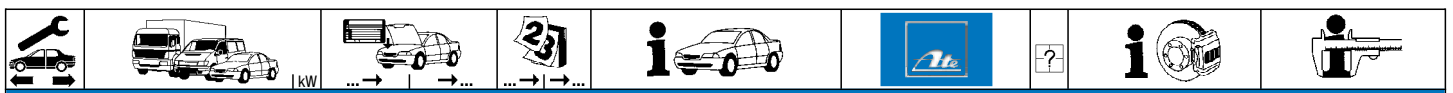

PORSCHE 914/4 (69-76)											
	1.7 1.8 2.0 2.0	59 63 65 74		01.70 01.74 01.75 01.73	12.73 12.76 12.76 12.76		03.2117-1601.3	010039		THz 17,46 + WE	ATE
	1.7	59		01.70	12.72		13.0441-4209.2	250088		Dichtungssatz	ATE
	1.7	59		01.70	12.72		13.0460-4033.2	604033		20034 15,0	ATE
	1.7 1.8 2.0 2.0	59 47279 19032 63 47279 19032 65 47279 19032 74 47279 19032			12.72 12.72 12.72 12.72		13.0462-4855.2	600018		20910 15,0 /WE	ATE
	1.7 1.8 2.0 2.0	59 47229 19033 63 47229 19033 65 47229 19033 74 47229 19033			12.73 12.76 12.76 12.76		13.0462-4855.2	600018		20910 15,0 /WE	ATE
	1.7 1.7 1.8 2.0 2.0	59 59 63 65 74		01.70 01.72 01.74 01.75 01.73	12.71 12.73 12.76 12.76 12.76		24.5225-0300.3	331266	2	L=300	
	1.7 1.7 1.8 2.0 2.0	59 59 63 65 74		01.70 01.72 01.74 01.75 01.73	12.73 12.73 12.76 12.76 12.76		24.5224-0295.3	331261	2	L=295	
	1.7 1.8 2.0 2.0	59 63 65 74		01.70 01.74 01.75 01.73	12.73 12.76 12.76 12.76		13.0441-3302.2	250042		Dichtungssatz	ATE
	1.7 1.8 2.0 2.0	59 63 65 74		01.70 01.74 01.75 01.73	02.73 12.76 12.76 12.76		24.5224-0240.3	331260	2	L=240	

PORSCHE 914/6 (70-73)											
	2.0	81		01.70	12.72		03.2119-2301.3 03.2119-0881.3	010055 010053		THz 19,05 THz 19,05 + WE	ATE ATE
	2.0	81		01.70	12.72		13.2481-9999.2 13.2481-9998.2 13.0441-4815.2	210103 210102 250102		D=48 D=48 Dichtungssatz	ATE ATE ATE
	2.0	81 47279 19032			12.72		13.0462-4855.2	600018		20910 15,0 /WE	ATE
	2.0	81 47229 19033			12.73		13.0462-4855.2	600018		20910 15,0 /WE	ATE
	2.0	81		01.70	12.72		24.0120-0103.1	420103		283 20,5 19,1 V L	
	2.0	81		01.70	12.72		24.5225-0300.3	331266	2	L=300	
	2.0	81		01.70	12.72		13.0441-3810.2	250066		Dichtungssatz	ATE
	2.0	81		01.70	12.72		24.5224-0240.3	331260	2	L=240	





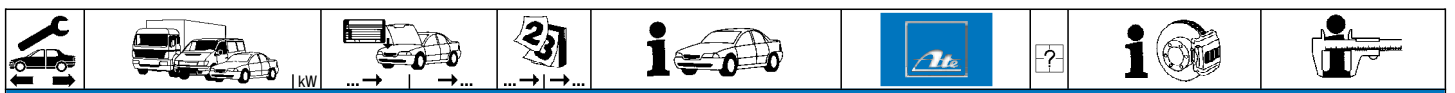































PORSCHE 924 (76-85)											
	2.0 2.0 CARRERA GT 2.0 Turbo 2.0 Turbo	92 154 125 130		01.80 06.80 01.80 01.81	12.85 12.81 12.80 12.84		03.7750-5702.4	300083		9"	ATE
	2.0 2.0 2.0	74 85 92		01.77 01.77 01.76	12.77 12.79 12.79		03.2120-0322.3	010074		THz 20,64 + WE	ATE
	2.0 Turbo	125		01.77	12.77		03.2123-9002.3	010198		THz 23,81 + WE	ATE
	2.0 2.0 Turbo	92 125		01.80 01.80	12.80 12.80		03.2123-7902.3	010191		THz 23,81 + WE	ATE
	2.0 2.0 Turbo	92 130		01.81 01.81	12.85 12.84		03.2123-8902.3	010197		THz 23,81	ATE
	2.0 CARRERA GT	154		06.80	12.81		03.2023-0172.3	010016		THz 23,81/19,05	ATE
	2.0 2.0 2.0	74 85 92		01.77 01.77 01.76	12.77 12.79 12.79		11.0441-4802.2	250017		Dichtungssatz	ATE
	2.0 2.0 CARRERA GT 2.0 Turbo 2.0 Turbo 2.0 Turbo	92 154 125 125 130		01.80 06.80 01.79 01.80 01.81	12.85 12.81 12.79 12.80 12.84		11.0441-5401.2	250027		Dichtungssatz	ATE
	2.0 2.0 2.0	74 85 92		01.77 01.77 01.76	12.77 12.79 12.79		13.0460-3612.2	603612		20482 18,5 /WE	ATE
	2.0 2.0 2.0	74 85 92		01.77 01.77 01.76	12.77 12.79 12.79		24.0113-0170.1	413170		257 13,0 11,5	
	2.0 2.0 CARRERA GT	92 154		01.80 06.80	12.85 12.81		24.0120-0103.1	420103		283 20,5 19,1 V L	





































PORSCHE 924 (76-85)										
	2.0 Turbo	125		01.77	12.77	24.0120-0103.1	420103			283 20,5 19,1 V L
	2.0 Turbo	125		01.80	12.80					
	2.0 Turbo	130		01.81	12.84					
	2.0	74		01.77	12.77	24.5171-0393.3	331311	2		L=393
	2.0	85		01.77	12.79					
	2.0	92		01.76	12.79					
	2.0	92		01.80	12.85	83.6101-0412.3	330212	2		L=410
	2.0 CARRERA GT	154		06.80	12.81					
	2.0 Turbo	125		01.77	12.77					
	2.0 Turbo	125		01.80	12.80					
	2.0 Turbo	130		01.81	12.84					
	2.0 CARRERA GT	154		06.80	12.81	11.0441-3601.2	250007			Dichtungssatz ATE
	2.0 Turbo	125		01.77	12.77					
	2.0 Turbo	125		01.80	12.80					
	2.0 Turbo	130		01.81	12.84					
	2.0 CARRERA GT	154		06.80	12.81	13.0460-3612.2	603612			20482 18,5 /WE ATE
	2.0 Turbo	125		01.77	12.77					
	2.0 Turbo	125		01.80	12.80					
	2.0 Turbo	130		01.81	12.84					
	2.0 CARRERA GT	154		06.80	12.81	24.0120-0112.1	420112			289 19,9 18,7 V L
	2.0 Turbo	125		01.77	12.77					
	2.0 Turbo	125		01.80	12.80					
	2.0 Turbo	130		01.81	12.84					
	2.0	74		01.77	12.77	83.6201-0175.3	330663	2		L=175
	2.0	85		01.77	12.79					
	2.0	92		01.76	12.85					
	2.0 CARRERA GT	154		06.80	12.81					
	2.0 Turbo	125		01.79	12.79					
	2.0 Turbo	125		01.80	12.80					
	2.0 Turbo	130		01.81	12.84					
	2.0	74		01.77	12.77	24.3219-0906.3	020187			Rz 19,05
	2.0	85		01.77	12.79					
	2.0	92		01.76	12.85					
	2.0	74		01.77	12.77	03.0137-0041.2	650041			230 x 40 ATE
	2.0	85		01.77	12.79	03.0137-9005.2	669005			Bremsbacken-Zubehör
	2.0	92		01.76	12.85					
	2.0	74		01.77	12.77	24.0223-0004.1	480034			230/231 x 50,5
	2.0	85		01.77	12.79					
	2.0	92		01.76	12.85					
	2.0	74		01.77	12.77	24.3727-0902.2	580902	<input type="checkbox"/>		L=2034
	2.0	85		01.77	12.79					
	2.0	92		01.76	12.80					
	2.0 Turbo	125		01.80	12.80					
	2.0	74		01.77	12.77	24.2419-0926.3	030054			Gz 19,05
	2.0	85		01.77	12.79					
	2.0	92		01.76	12.85					
	2.0 CARRERA GT	154		06.80	12.81					
	2.0 Turbo	125		01.79	12.79					
	2.0 Turbo	125		01.80	12.80					
	2.0 Turbo	130		01.81	12.84					
PORSCHE 924S (86-88)										
	2.5 S	110		09.85	07.87	03.7750-5702.4	300083			9" ATE
	2.5 S	118		08.87	12.88					
	2.5 S	110		09.85	07.87	03.2023-0172.3	010016			THz 23,81/19,05 ATE
	2.5 S	118		08.87	12.88					
	2.5 S	110		09.85	07.87	11.0441-5401.2	250027			Dichtungssatz ATE
	2.5 S	118		08.87	12.88					
	2.5 S	110		09.85	07.87	24.0120-0103.1	420103			283 20,5 19,1 V L
	2.5 S	118		08.87	12.88					
	2.5 S	110		09.85	07.87	83.6101-0412.3	330212	2		L=410
	2.5 S	118		08.87	12.88					
	2.5 S	110		09.85	07.87	11.0441-3601.2	250007			Dichtungssatz ATE
	2.5 S	118		08.87	12.88					
	2.5 S	110		09.85	07.87	13.0460-3612.2	603612			20482 18,5 /WE ATE
	2.5 S	118		08.87	12.88					
	2.5 S	110		09.85	07.87	24.0120-0112.1	420112			289 19,9 18,7 V L
	2.5 S	118		08.87	12.88					
	2.5 S	110		09.85	07.87	83.6201-0175.3	330663	2		L=175
	2.5 S	118		08.87	12.88					
	2.5 S	110		09.85	07.87	03.0137-3002.2	653002			180 x 25
	2.5 S	118		08.87	12.88					

































								
PORSCHE 924S (86-88)								
	2.5 S 2.5 S	110 118		09.85 08.87	07.87 12.88	24.2419-0926.3	030054	Gz 19,05
	2.5 S 2.5 S	110 118		09.85 08.87	07.87 12.88	24.2523-0903.3	040045	Nz 23,81
PORSCHE 928 (77-95)								
	4.5 4.7 S 4.7 S 4.7 S 5.0 GT 5.0 S4 5.4 GTS	177 212 221 228 243 235 257	92A0800750	08.82 09.85 09.79 08.83 01.89 08.86 08.91	08.82 12.86 12.83 12.86 07.91 07.91 11.95	03.7760-0402.4	300087	10" ATE
	4.5 4.7 S 4.7 S	177 221 228		09.77 09.79 08.83	08.82 12.83 12.86	03.2123-9002.3	010198	THz 23,81 + WE ATE
	4.7 S 4.7 S 4.7 S 5.0 GT 5.0 S4 5.4 GTS	228 212 228 243 235 257		08.83 09.85 08.83 01.89 08.86 08.91	12.86 12.86 07.91 07.91 07.91 11.95	03.2023-0183.3	010017	THz 23,81/19,05 ATE
	4.7 S 4.7 S 5.0 GT 5.0 S4 5.4 GTS	212 228 243 235 257		09.85 08.83 01.89 08.86 08.91	12.86 12.86 07.91 07.91 11.95	03.2023-0262.3	010020	THz 23,81/20,64 ATE
	4.5 4.5 4.7 S 4.7 S	177 177 221 228	92A0800749	09.77 08.82 09.79 08.83	09.77 08.82 12.83 12.85	11.0441-5401.2	250027	Dichtungssatz ATE
	4.5 4.5 4.7 S 4.7 S	177 177 221 228	92A0800750	09.77 08.82 09.79 08.83	09.77 08.82 12.83 12.85	11.0441-5402.2	250028	Dichtungssatz ATE
	4.7 S 4.7 S 5.0 GT 5.0 S4 5.4 GTS	212 228 243 235 257		09.85 01.86 01.89 08.86 08.91	12.86 12.86 07.91 07.91 11.95	11.0101-5407.2	260011	Hülensatz ATE
	4.7 S 4.7 S 5.0 GT 5.0 S4 5.4 GTS	212 228 243 235 257		09.85 01.86 01.89 08.86 08.91	12.86 12.86 07.91 07.91 11.95	11.8171-0008.1	990049	Führungsbolzen ATE
	4.7 S 4.7 S 5.0 GT 5.0 S4 5.4 GTS	212 228 243 235 257		09.85 01.86 01.89 08.86 08.91	12.86 12.86 07.91 07.91 11.95	24.8190-0909.2	620909	Warnkontakt L=207mm
	4.7 S 4.7 S 5.0 GT 5.0 S4 5.4 GTS	212 228 243 235 257		09.85 01.86 01.89 08.86 08.91	12.86 12.86 07.91 07.91 11.95	24.8190-0915.2	620915	Warnkontakt L=333mm
	4.5 4.5 4.7 S 4.7 S	177 177 221 228	92A0800750	09.77 08.82 09.79 08.83	08.82 12.83 12.83 12.85	13.0460-4056.2	604056	21402 17,5 /WE BRE
	4.5 4.5 4.7 S 4.7 S	177 177 221 228	92A0800749	09.77 08.82 09.79 08.83	08.82 12.83 12.83 12.85	24.8190-0925.2	620925	2 Warnkontakt L=265mm
	4.5 4.5 4.7 S 4.7 S	177 177 221 228	92A0800750	09.77 08.82 09.79 08.83	08.82 12.83 12.83 12.85	24.0132-0127.1	432127	282 32,0 30,6 V L
	4.5 4.5 4.7 S 4.7 S	177 177 221 228	92A0800749	09.77 08.82 09.79 08.83	08.82 12.83 12.83 12.85	24.0132-0128.1	432128	282 32,0 30,6 V L
	4.7 S 4.7 S 5.0 GT 5.0 S4 5.4 GTS	212 228 243 235 257		09.85 01.86 01.89 08.86 08.91	12.86 12.86 07.91 07.91 11.95	24.0132-0151.1	432151	304 32,0 30,0 V L +B
	4.7 S 4.7 S 5.0 GT 5.0 S4 5.4 GTS	212 228 243 235 257		09.85 01.86 01.89 08.86 08.91	12.86 12.86 07.91 07.91 11.95	24.0132-0150.1	432150	304 32,0 30,0 V L +B
	4.5 4.5 4.7 S 4.7 S	177 177 221 228	92A0800749	09.77 08.82 09.79 08.83	08.82 12.83 12.83 12.85	83.6121-0340.3	330261	L=340
	4.5 4.5 4.7 S 4.7 S	177 177 221 228	92A0800749	09.77 08.82 09.79 08.83	08.82 12.83 12.83 12.85	83.6289-0391.3	330341	L=390
	4.5 4.5 4.7 S 4.7 S	177 177 221 228		09.77 08.82 09.79 08.83	08.82 12.83 12.83 12.85	11.0441-3601.2	250007	Dichtungssatz ATE
	4.5 4.5 4.7 S 4.7 S	177 177 221 228		09.77 08.82 09.79 08.83	08.82 12.83 12.83 12.85	13.0460-3612.2	603612	20482 18,5 /WE ATE
	4.5 4.5 4.7 S 4.7 S	177 177 221 228		09.77 08.82 09.79 08.83	08.82 12.83 12.83 12.85	24.8190-0903.2	620903	2 Warnkontakt L=1005mm
	4.5 4.5 4.7 S 4.7 S	177 177 221 228		09.77 08.82 09.79 08.83	08.82 12.83 12.83 12.85	13.0460-3612.2	603612	20482 18,5 /WE ATE
	4.7 S 4.7 S 5.0 GT 5.0 S4 5.4 GTS	212 228 243 235 257		09.85 01.86 01.89 08.86 08.91	12.86 12.86 07.91 07.91 11.95	24.8190-0910.2	620910	Warnkontakt L=515mm
	4.7 S 4.7 S 5.0 GT 5.0 S4 5.4 GTS	212 228 243 235 257		09.85 01.86 01.89 08.86 08.91	12.86 12.86 07.91 07.91 11.95	24.8190-0919.2	620919	2 Warnkontakt L=638mm
	4.5 4.5 4.7 S 4.7 S	177 177 221 228		09.77 08.82 09.79 08.83	08.82 12.83 12.83 12.85	24.0120-0112.1	420112	289 19,9 18,7 V L
	4.5 4.5 4.7 S 4.7 S	177 177 221 228		09.77 08.82 09.79 08.83	08.82 12.83 12.83 12.85	24.0124-0116.1	424116	299 24,0 22,0 V L
	4.5 4.5 4.7 S 4.7 S	177 177 221 228	9289101485	09.77 08.82 09.85 09.79	08.82 12.86 12.86 12.83	83.6101-0250.3	330203	L=250
	4.5 4.5 4.7 S 4.7 S	177 177 221 228	9289101486	09.77 08.82 09.85 09.79	08.82 12.86 12.86 12.83	83.6121-0250.3	330260	L=250
	4.5 4.5 4.7 S 4.7 S	177 177 221 228		09.77 08.82 09.85 09.79	08.82 12.83 12.86 12.83	03.0137-3002.2	653002	180 x 25
	4.5 4.5 4.7 S 4.7 S	177 177 221 228		09.77 08.82 09.85 09.79	08.82 12.83 12.86 12.83			
	4.5 4.5 4.7 S 4.7 S	177 177 221 228		09.77 08.82 09.85 09.79	08.82 12.83 12.86 12.83			
	5.0 GT 5.0 S4 5.4 GTS	243 235 257		01.89 08.86 08.91	07.91 07.91 11.95			



										
PORSCHE 928 (77-95)										
	5.0 GT 5.0 S4 5.4 GTS	243 235 257		01.89 08.86 08.91	07.91 07.91 11.95		24.2522-0908.3	040044		Nz 22,20
PORSCHE 944 (81-91)										
	944 944 S 944 Turbo			10.81 01.87 04.85	12.89 08.91 08.91		03.7750-5702.4	300083		9" ATE
	944 944 Turbo			10.81 04.85	12.86 12.86	- ABS - ABS	03.2023-0172.3	010016		THz 23,81/19,05 ATE
	944 944 S 944 Turbo			01.87 01.87 01.87	12.89 08.91 08.91	- ABS - ABS - ABS	03.2023-0562.3	010025		THz 23,81/20,64 ATE
	944 944 S 944 Turbo			01.85 01.85 04.85	12.89 08.91 08.91	+ ABS + ABS + ABS	03.2023-0542.3 03.3517-0101.2	010024 390322		THz 23,81/20,64 Verschlusschraube ATE
	944 944 S			10.81 01.87	12.89 12.88		11.0441-5401.2	250027		Dichtungssatz ATE
	944 944 S			10.81 01.87	12.89 12.88		24.8190-0904.2	620904	2	Warnkontakt L=275mm
	944 S2 944 Turbo			01.89 04.85	08.91 07.88		24.8190-0904.2 24.8190-0916.2	620904 620916	2 2	Warnkontakt L=275mm Warnkontakt L=395mm
	944 Turbo			08.88	08.91		24.8190-0916.2	620916	2	Warnkontakt L=395mm
	944 944 944 S			10.81 01.87 01.87	12.86 12.89 12.88		24.0120-0103.1 24.0121-0112.1	420103 421112		283 20,5 19,1 V L 282 20,5 19,0 V L +B
	944 Turbo			04.85	12.86		24.0128-0165.1	428165		298 28,0 26,0 V L
	944 S2 944 Turbo			01.89 01.87	12.91 12.88	- Sportfahrwerk ¹⁾	24.0128-0167.1	428167		298 28,0 26,0 V L +B
	944 S2 944 Turbo			01.89 01.89	12.91 12.91	+ Sportfahrwerk ²⁾	24.0132-0151.1 24.0132-0150.1	432151 432150	<input type="checkbox"/> <input type="checkbox"/>	304 32,0 30,0 V L +B 304 32,0 30,0 V L +B
	944 944 944 S			10.81 01.87 01.87	12.86 12.89 08.91		83.6101-0412.3 24.5165-0415.3	330212 331320	2 2	L=410 L=415
	944 Turbo			01.87	08.91		83.6251-0301.3	330556	2	L=300
	944 944 S 944 Turbo			10.81 01.87 04.85	12.89 08.91 08.91		11.0441-3601.2	250007		Dichtungssatz ATE
	944 944 S			10.81 01.87	12.89 12.88		13.0460-3612.2 24.8190-0905.2 24.8190-0913.2	603612 620905 620913	2 2	20482 18,5 /WE ATE Warnkontakt L=357mm Warnkontakt L=308mm
	944 S 944 Turbo			01.89 04.85	08.91 08.91		24.8190-0916.2	620916	2	Warnkontakt L=395mm
	944 944 944 S			10.81 01.87 01.87	12.86 12.89 12.88		24.0120-0112.1 24.0120-0104.1	420112 420104		289 19,9 18,7 V L 289 20,0 18,6 V L
	944 Turbo			04.85	12.86		24.0124-0116.1	424116		299 24,0 22,0 V L
	944 S 944 Turbo			01.89 01.87	08.91 08.91		24.0124-0117.1	424117		299 24,0 22,0 V L
	944			10.81	07.84		83.6201-0175.3	330663	2	L=175
	944 944 S 944 Turbo			10.81 01.87 01.85	12.89 12.89 12.89		24.2419-0926.3	030054		Gz 19,05
	944 944 S 944 Turbo			01.85 01.87 08.85	12.89 08.91 08.91		24.2523-0903.3	040045		Nz 23,81
PORSCHE 968 COUPE (91-95)										
	3.0	176		06.91	11.95		03.7750-5702.4	300083		9" ATE
	3.0	176		06.91	11.95		03.2023-0542.3 03.3517-0101.2	010024 390322		THz 23,81/20,64 Verschlusschraube ATE
	3.0	176		06.91	11.95	- Sportfahrwerk ¹⁾	24.8190-0916.2	620916	2	Warnkontakt L=395mm
	3.0	176		06.91	11.95	+ Sportfahrwerk ²⁾	24.8190-0916.2	620916	2	Warnkontakt L=395mm
	3.0	176		06.91	11.95	- Sportfahrwerk ¹⁾	24.0128-0167.1	428167		298 28,0 26,0 V L +B
	3.0	176		06.91	11.95	- Sportfahrwerk ¹⁾	24.5165-0415.3	331320	2	L=415
	3.0	176		06.91	11.95	+ Sportfahrwerk ²⁾	83.6251-0301.3	330556	2	L=300
	3.0	176		06.91	11.95		24.8190-0916.2	620916	2	Warnkontakt L=395mm

¹⁾ - sports suspension / - sospensione sportiva / - châssis de sport / - suspensión deportiva

²⁾ + sports suspension / + sospensione sportiva / + châssis de sport / + suspensión deportiva



























										
PORSCHE 968 COUPE (91-95)										
	3.0	176		06.91	11.95	- Sportfahrwerk ¹⁾	24.0124-0117.1	424117	299 24,0 22,0 V L	
	3.0	176		06.91	11.95		83.6201-0175.3	330663	2	L=175
PORSCHE 968 CABRIO (91-95)										
	3.0	176		06.91	11.95		03.7750-5702.4	300083		9" ATE
	3.0	176		06.91	11.95		03.2023-0542.3 03.3517-0101.2	010024 390322		THz 23,81/20,64 Verschlusschraube ATE
	3.0	176		06.91	11.95	- Sportfahrwerk ¹⁾	24.8190-0916.2	620916	2	Warnkontakt L=395mm
	3.0	176		06.91	11.95	+ Sportfahrwerk ²⁾	24.8190-0916.2	620916	2	Warnkontakt L=395mm
	3.0	176		06.91	11.95	- Sportfahrwerk ¹⁾	24.0128-0167.1	428167		298 28,0 26,0 V L +B
	3.0	176		06.91	11.95	- Sportfahrwerk ¹⁾	24.5165-0415.3	331320	2	L=415
	3.0	176		06.91	11.95	+ Sportfahrwerk ²⁾	83.6251-0301.3	330556	2	L=300
	3.0	176		06.91	11.95		24.8190-0916.2	620916	2	Warnkontakt L=395mm
	3.0	176		06.91	11.95	- Sportfahrwerk ¹⁾	24.0124-0117.1	424117		299 24,0 22,0 V L
	3.0	176		06.91	11.95		83.6201-0175.3	330663	2	L=175
RENAULT ALPINE A310 (77-84)										
	2.7 (2700VA)		0047708	01.77		- ☉	13.0460-3928.2	603928		20140 14,0 +/-WE BDX
	2.7 (2700VA)		0047708	01.77			13.0460-3961.2	603961		20336 14,0 +/-WK BDX
	2.7 (2700VA)			01.77	12.84		24.2528-0908.3	040065		Nz 28,57
RENAULT ESPACE I (J/S 11_) (84-90)										
	2.0 (J/S112)	74		01.88	12.90		03.2120-2031.3	010106		THz 20,64 ATE
	2.0 (J/S112)	80	T022234		12.90					
	2.0 (J/S112)	80	T000349		12.90					
	2.0 i (J116)	87		01.89	12.90	- ABS				
	2.0 i Quadra (J116)	87		03.88	12.90	- ABS				
	2.1 TD (J/S115)	65	T012278		12.90					
	2.1 TD (J/S115)	65	T000494		12.90					
	2.2 (J117)	79		07.86	12.90	- ABS				
	2.2 Quadra	81		06.87	12.87	- ABS				
	2.2 Quadra (J117)	79		01.88	12.90	- ABS				
	2.0 (J/S112)	74		01.88	12.90		24.3541-1625.5	240045		D=54, - Halter LUC
	2.0 (J/S112)	80		07.84	12.90		24.3541-1626.5	240046		D=54, - Halter LUC
	2.0 i (J116)	87		01.89	12.90					
	2.0 i Quadra (J116)	87		03.88	12.92					
	2.1 TD (J/S115)	65		10.84	12.90					
	2.2 (J117)	79		07.86	12.90					
	2.2 Quadra	81		06.87	12.87					
	2.2 Quadra (J117)	79		01.88	12.90					
	2.0 (J/S112)	74		01.88	12.90		13.0460-3911.2	603911		20905 18,0 +/-WK BDX
	2.0 (J/S112)	80		07.84	12.90		13.0460-2834.2	602834		21463 18,0 /WK/S LUC
	2.0 i (J116)	87		01.89	12.90		13.0460-0411.2	610411		Belagsatz-Zubehör BDX
	2.0 i Quadra (J116)	87		03.88	12.92					
	2.1 TD (J/S115)	65		10.84	12.90					
	2.2 (J117)	79		07.86	12.90					
	2.2 Quadra	81		06.87	12.87					
	2.2 Quadra (J117)	79		01.88	12.90					
	2.0 (J/S112)	80	T022233	07.84			24.0120-0148.1	420148		238 20,0 17,7 V
	2.0 (J/S112)	80	T000348	01.86						
	2.1 TD (J/S115)	65	T012277	10.84						
	2.1 TD (J/S115)	65	T000493	01.86						
	2.0 (J/S112)	74		01.88	12.90		24.0120-0126.1	420126		259 20,2 17,7 V +B
	2.0 (J/S112)	80	T022234		12.90					
	2.0 (J/S112)	80	T000349		12.90					
	2.0 i (J116)	87		01.89	12.90					
	2.0 i Quadra (J116)	87		03.88	12.92					
	2.1 TD (J/S115)	65	T012278		12.90					
	2.1 TD (J/S115)	65	T000494		12.90					
	2.2 (J117)	79		07.86	12.90					
	2.2 Quadra	81		06.87	12.87					

¹⁾ - sports suspension / - sospensione sportiva / - châssis de sport / - suspensión deportiva
²⁾ + sports suspension / + sospensione sportiva / + châssis de sport / + suspensión deportiva



RENAULT ESPACE I (J/S 11_) (84-90)									
	2.2 Quadra (J117)	79		01.88	12.90	24.0120-0126.1	420126		259 20,2 17,7 V +B
	2.0 (J/S112)	74		01.88	12.90	24.5112-0385.3	330392	2	L=385
	2.0 (J/S112)	80		07.84	12.90				
	2.0 i (J116)	87		01.89	12.90				
	2.0 i Quadra (J116)	87		03.88	12.92				
	2.1 TD (J/S115)	65		10.84	12.90				
	2.2 (J117)	79		07.86	12.90				
	2.2 Quadra	81		06.87	12.87				
	2.2 Quadra (J117)	79		01.88	12.90				
	2.0 i (J116)	87		01.89	12.90 + ABS	13.0460-3961.2	603961		20336 14,0 +/WK BDX
	2.0 i Quadra (J116)	87		03.88	12.92				
	2.1 TD (J/S115)	65		10.84	12.90 + Niveauregulierung 1)				
	2.2 (J117)	79		07.86	12.90 + ABS				
	2.2 Quadra	81		06.87	12.87				
	2.2 Quadra (J117)	79		01.88	12.90				
	2.0 i (J116)	87		01.89	12.90 + ABS	24.0112-0134.1	412134		254 12,0 10,5
	2.1 TD (J/S115)	65		10.84	12.90 + Niveauregulierung 1)				
	2.2 (J117)	79		07.86	12.90 + ABS				
	2.0 i Quadra (J116)	87		03.88	12.92	24.0111-0122.1	411122		255 10,5 9,5
	2.2 Quadra	81		06.87	12.87				
	2.2 Quadra (J117)	79		01.88	12.90				
	2.0 (J/S112)	74		01.88	12.90 - ABS/ - Niveauregulierung 2)	24.5228-0350.3	330396	2	L=350
	2.0 (J/S112)	80		07.84	12.90 - ABS/ - Niveauregulierung 2)				
	2.0 i (J116)	87		01.89	12.90 - ABS/ - Niveauregulierung 2)				
	2.1 TD (J/S115)	65		10.84	12.90 - ABS/ - Niveauregulierung 2)				
	2.2 (J117)	79		07.86	12.90 - ABS/ - Niveauregulierung 2)				
	2.0 (J/S112)	74		01.88	12.90 + ABS/ + Niveauregulierung 3)	24.5112-0220.3	330613	2	L=220
	2.0 (J/S112)	80		07.84	12.90 + ABS/ + Niveauregulierung 3)				
	2.0 i (J116)	87		01.89	12.90 + ABS/ + Niveauregulierung 3)				
	2.1 TD (J/S115)	65		10.84	12.90 + ABS/ + Niveauregulierung 3)				
	2.2 (J117)	79		07.86	12.90 + ABS/ + Niveauregulierung 3)				
	2.0 (J/S112)	74		01.88	12.90	24.3222-1118.3	020315		Rz 22,20 BDX
	2.0 (J/S112)	80		07.84	12.90				
	2.0 i (J116)	87		01.89	12.90 - ABS				
	2.1 TD (J/S115)	65		10.84	12.90 - Niveauregulierung 4)				
	2.2 (J117)	79		07.86	12.90 - ABS				
	2.0 (J/S112)	74		01.88	12.90	03.0137-0124.2	650124		229 x 42 HEB AUT BDX
	2.0 (J/S112)	80		07.84	12.90	03.0137-9020.2	669020		BDX
	2.0 i (J116)	87		01.89	12.90 - ABS				
	2.1 TD (J/S115)	65		10.84	12.90 - Niveauregulierung 4)				
	2.2 (J117)	79		07.86	12.90 - ABS				
	2.0 (J/S112)	74		01.88	12.90	24.0222-8015.1	480055		229/229,5 x 52,5
	2.0 (J/S112)	80		07.84	12.90	24.0222-8019.2	480087		229/229,5 x 52,5
	2.0 i (J116)	87		01.89	12.90 - ABS				
	2.1 TD (J/S115)	65		10.84	12.90 - Niveauregulierung 4)				
	2.2 (J117)	79		07.86	12.90 - ABS				
	2.0 (J/S112)	74		01.88	12.90	03.0520-3122.3	693122		22,20/229x42 TopKit BDX
	2.0 (J/S112)	80		07.84	12.90				
	2.0 i (J116)	87		01.89	12.90 - ABS				
	2.1 TD (J/S115)	65		10.84	12.90 - Niveauregulierung 4)				
	2.2 (J117)	79		07.86	12.90 - ABS				
	2.0 (J/S112)	74		01.88	12.90	24.3727-1031.2	581031	1 ↓	L=1984/1045
	2.0 (J/S112)	80	T005830	07.84	12.90 +				
	2.0 (J/S112)	80		01.89	12.90 - Niveauregulierung 4)				
	2.0 i (J116)	87		10.84	12.90 - Niveauregulierung 4)				
	2.1 TD (J/S115)	65		07.86	12.90 - Niveauregulierung 4)				
	2.2 (J117)	79							
	2.0 (J/S112)	74	T041871	01.88		03.6583-0005.3	320099		BRL 8/3 (4) ATE
	2.0 (J/S112)	74	K001772	01.88					
	2.0 (J/S112)	80	T041871	07.84					
	2.0 (J/S112)	80	T000771	01.86					
	2.0 (J/S112)	80	K001772	07.84					
	2.0 i (J116)	87	T004699	01.89	- Niveauregulierung 4)				
	2.0 i (J116)	87	K001363	01.89	- Niveauregulierung 4)				
	2.1 TD (J/S115)	65	T031062	10.84	- Niveauregulierung 4)				
	2.1 TD (J/S115)	65	T001266	01.86					
	2.2 (J117)	79	T009177	07.86	- Niveauregulierung 4)				
	2.0 (J/S112)	74		01.88	12.90	24.3728-1010.2	591010		L=702
	2.0 (J/S112)	80		07.84	12.90				
	2.0 i (J116)	87		01.89	12.90				
	2.0 i Quadra (J116)	87		03.88	12.92				
	2.2 (J117)	79		07.86	12.90				
	2.2 Quadra	81		06.87	12.87				
	2.2 Quadra (J117)	79		01.88	12.90				
RENAULT ESPACE II (J/S 63_) (91-96)									
	2.0 (J/ - 636)	76		01.91	10.96	03.6750-2902.4	300037		9° ATE
	2.1 RTDT Quadra	65		01.91	05.92				
	2.1 TD (J633-635,63D)	65		01.91	10.96				
	2.1 TD (J63E)	66		11.94	10.96				
	2.2 (J/S637,J63G)	79		01.91	10.96				
	2.2 4x4 (J/S637,J63G)	79		03.91	12.96				

1) + suspension level control / + correttore assetto / + correcteur d'assiette / + regulación altura suspensión
2) - ABS/ - suspens.level control / - ABS/ - correttore assetto / - ABS/ - correcteur d'assiette / - ABS/ - regul.alt.suspension
3) + ABS/ + suspens.level control / + ABS/ + correttore d'assetto / + ABS/ + correcteur d'assiette / + ABS/ + regul.alt.suspension
4) - suspension level control / - correttore assetto / - correcteur d'assiette / - regulación altura suspensión

											
RENAULT ESPACE II (J/S 63_) (91-96)											
	2.0 (J/- 636)	76		01.91	10.96	- ABS/ - Niveauregulierung ¹⁾	03.2120-2682.3	010118		Thz 20,64	ATE
	2.1 RTDT Quadra	65		01.91	05.92	- Niveauregulierung ²⁾					
	2.1 TD (J633-635,63D)	65		01.91	10.96	- Niveauregulierung ²⁾					
	2.2 (J/S637,J63G)	79		01.91	10.96	- ABS/ - Niveauregulierung ¹⁾					
	2.2 4x4 (J/S637,J63G)	79		03.91	12.96	- ABS/ - Niveauregulierung ¹⁾					
	2.0 (J/- 636)	76		01.91	10.96	- ABS	03.2122-9631.3	010160		Thz 22,20	ATE
	2.1 RTDT Quadra	65		01.91	05.92	- ABS					
	2.1 TD (J633-635,63D)	65		01.91	10.96	- ABS					
	2.1 TD (J63E)	66		11.94	10.96	- ABS					
	2.2 (J/S637,J63G)	79		01.91	10.96	- ABS					
	2.0 (J/- 636)	76		07.93	10.96	+ ABS	03.2122-0626.3	010539		Thz 22,20	ATE
	2.1 TD (J633-635,63D)	65		07.93	10.96	+ ABS					
	2.1 TD (J63E)	66		11.94	10.96	+ ABS					
	2.2 (J/S637,J63G)	79		07.93	10.96	+ ABS					
	2.2 4x4 (J/S637,J63G)	79		07.93	12.96	+ ABS					
	2.8 V6 (J638,J63J)	110		01.91	10.96		24.2123-1701.3	010424		Thz 23,81	
	2.0 (J/- 636)	76		01.91	10.96		24.3541-1625.5	240045		D=54, - Halter	LUC
	2.1 RTDT Quadra	65		01.91	05.92		24.3541-1626.5	240046		D=54, - Halter	LUC
	2.1 TD (J633-635,63D)	65		01.91	10.96						
	2.1 TD (J63E)	66		11.94	10.96						
	2.2 (J/S637,J63G)	79		01.91	10.96						
	2.2 4x4 (J/S637,J63G)	79		03.91	12.96						
	2.0 (J/- 636)	76		01.91	10.96		13.0460-2810.2	602810		20236 18,0 +/-WK/S	LUC
	2.1 RTDT Quadra	65		01.91	05.92						
	2.1 TD (J633-635,63D)	65		01.91	10.96						
	2.1 TD (J63E)	66		11.94	10.96						
	2.2 (J/S637,J63G)	79		01.91	10.96						
	2.2 4x4 (J/S637,J63G)	79		03.91	12.96						
	2.8 V6 (J638,J63J)	110		01.91	10.96		13.0460-2983.2	602983		21388 18,0 +/-WK/S	LUC
	2.0 (J/- 636)	76		01.91	10.96		24.0120-0126.1	420126		259 20,2 17,7 V +B	
	2.1 RTDT Quadra	65		01.91	05.92						
	2.1 TD (J633-635,63D)	65		01.91	10.96						
	2.1 TD (J63E)	66		11.94	10.96						
	2.2 (J/S637,J63G)	79		01.91	10.96						
	2.2 4x4 (J/S637,J63G)	79		03.91	12.96						
	2.8 V6 (J638,J63J)	110		01.91	10.96		24.0122-0143.1	422143		280 22,0 20,0 V	
	2.0 (J/- 636)	76		01.91	10.96		24.5111-0396.3	330609	2	L=395	
	2.1 RTDT Quadra	65		01.91	05.92						
	2.1 TD (J633-635,63D)	65		01.91	10.96						
	2.1 TD (J63E)	66		11.94	10.96						
	2.2 (J/S637,J63G)	79		01.91	10.96						
	2.2 4x4 (J/S637,J63G)	79		03.91	12.96						
	2.0 (J/- 636)	76		01.91	10.96	+ ABS/ + Niveauregulierung ³⁾	13.0460-3961.2	603961		20336 14,0 +/-WK	BDX
	2.1 RTDT Quadra	65		01.91	05.92	+ Niveauregulierung ⁴⁾					
	2.1 TD (J633-635,63D)	65		01.91	10.96	+ Niveauregulierung ⁴⁾					
	2.1 TD (J63E)	66		11.94	10.96	+ Niveauregulierung ⁴⁾					
	2.2 (J/S637,J63G)	79		05.93	10.96	+ ABS/ + Niveauregulierung ³⁾					
	2.2 4x4 (J/S637,J63G)	79		05.93	12.96	+ ABS/ + Niveauregulierung ³⁾					
	2.8 V6 (J638,J63J)	110		01.91	10.96						
	2.0 (J/- 636)	76		01.91	10.96	+ ABS/ + Niveauregulierung ³⁾	24.0112-0134.1	412134		254 12,0 10,5	
	2.1 RTDT Quadra	65		01.91	05.92	+ Niveauregulierung ⁴⁾					
	2.1 TD (J633-635,63D)	65		01.91	10.96	+ Niveauregulierung ⁴⁾					
	2.1 TD (J63E)	66		11.94	10.96	+ Niveauregulierung ⁴⁾					
	2.2 (J/S637,J63G)	79		01.91	10.96	+ ABS/ + Niveauregulierung ³⁾					
	2.2 4x4 (J/S637,J63G)	79		05.93	12.96	+ ABS/ + Niveauregulierung ³⁾					
	2.2 4x4 (J/S637,J63G)	79		03.91	10.96		24.0111-0150.1	411150		257 10,5 9,5	
	2.8 V6 (J638,J63J)	110		01.91	10.96		24.0112-0133.1	412133		254 12,0 10,5	
	2.0 (J/- 636)	76		01.91	10.96		24.5112-0220.3	330613	2	Länge beachten ⁵⁾	L=220
	2.1 RTDT Quadra	65		01.91	05.92		24.5228-0350.3	330396	2	Länge beachten ⁵⁾	L=350
	2.1 TD (J633-635,63D)	65		01.91	10.96						
	2.1 TD (J63E)	66		11.94	10.96						
	2.2 (J/S637,J63G)	79		05.93	10.96						
	2.2 4x4 (J/S637,J63G)	79		05.93	12.96						
	2.8 V6 (J638,J63J)	110		01.91	10.96						
	2.2 (J/S637,J63G)	79		01.91	10.96		24.5112-0220.3	330613	2	Länge beachten ⁵⁾	L=220
	2.2 4x4 (J/S637,J63G)	79		03.91	12.96						
	2.0 (J/- 636)	76		01.91	10.96	- ABS/ - Niveauregulierung ¹⁾	24.3222-1118.3	020315		Rz 22,20	BDX
	2.1 RTDT Quadra	65		01.91	05.92	- Niveauregulierung ²⁾					
	2.1 TD (J633-635,63D)	65		01.91	10.96	- Niveauregulierung ²⁾					
	2.1 TD (J63E)	66		11.94	10.96	- Niveauregulierung ²⁾					
	2.2 (J/S637,J63G)	79		01.91	10.96	- ABS/ - Niveauregulierung ¹⁾					
	2.2 4x4 (J/S637,J63G)	79		03.91	12.96	- ABS/ - Niveauregulierung ¹⁾					
	2.0 (J/- 636)	76		01.91	10.96	- ABS/ - Niveauregulierung ¹⁾	24.3222-1615.3	020285		Rz 22,20	LUC
	2.1 RTDT Quadra	65		01.91	05.92	- Niveauregulierung ²⁾					
	2.1 TD (J633-635,63D)	65		01.91	10.96	- Niveauregulierung ²⁾					
	2.1 TD (J63E)	66		11.94	10.96	- Niveauregulierung ²⁾					
	2.2 (J/S637,J63G)	79		01.91	10.96	- ABS/ - Niveauregulierung ¹⁾					
	2.2 4x4 (J/S637,J63G)	79		03.91	12.96	- ABS/ - Niveauregulierung ¹⁾					
	2.0 (J/- 636)	76		01.91	10.96	- ABS/ - Niveauregulierung ¹⁾	03.0137-0124.2	650124		229 x 42 HEB AUT	BDX
	2.1 RTDT Quadra	65		01.91	05.92	- Niveauregulierung ²⁾	03.0137-9020.2	669020		Bremsbacken-Zubehör	BDX

1) - ABS/ - suspens.level control / - ABS/ - correttore assetto / - ABS/ - correcteur d'assiette / - ABS/ - regul.alt.suspensión
2) - suspension level control / - correttore assetto / - correcteur d'assiette / - regulación altura suspensión
3) + ABS/ + suspens.level control / + ABS/ + correttore d'assetto / + ABS/ + correcteur d'assiette / + ABS/ + regul.alt.suspensión
4) + suspension level control / + correttore assetto / + correcteur d'assiette / + regulación altura suspensión
5) notice length / attenzione lunghezza / faire attention longueur / atención largo



RENAULT ESPACE II (J/S 63_) (91-96)											
	2.2 4x4 (J/S637,J63G)	79		03.91	12.96	- ABS/ - Niveauregulierung ¹⁾	03.0137-0124.2	650124		229 x 42 HEB AUT	BDX
	2.0 (J/- 636)	76		01.91	10.96	- ABS/ - Niveauregulierung ¹⁾	03.0137-0271.2	650271		229 x 42 HEB	LUC
	2.1 RTDT Quadra	65		01.91	05.92	- Niveauregulierung ²⁾	03.0137-9020.2	669020		Bremsbacken-Zubehör	LUC
	2.1 TD (J633-635,63D)	65		01.91	10.96	- Niveauregulierung ²⁾					
	2.1 TD (J63E)	66		11.94	10.96	- Niveauregulierung ²⁾					
	2.2 (J/S637,J63G)	79		01.91	10.96	- ABS/ - Niveauregulierung ¹⁾					
2.2 4x4 (J/S637,J63G)	79		03.91	12.96	- ABS/ - Niveauregulierung ¹⁾						
	2.0 (J/- 636)	76		01.91	10.96	- ABS/ - Niveauregulierung ¹⁾	24.0222-8015.1	480055		229/229,5 x 52,5	
	2.1 RTDT Quadra	65		01.91	05.92	- Niveauregulierung ²⁾	24.0222-8019.2	480087		229/229,5 x 52,5	
	2.1 TD (J633-635,63D)	65		01.91	10.96	- Niveauregulierung ²⁾					
	2.1 TD (J63E)	66		11.94	10.96	- Niveauregulierung ²⁾					
	2.2 (J/S637,J63G)	79		01.91	10.96	- ABS/ - Niveauregulierung ¹⁾					
	2.2 4x4 (J/S637,J63G)	79		03.91	12.96	- ABS/ - Niveauregulierung ¹⁾					
	2.0 (J/- 636)	76		01.91	11.92	- ABS/ - Niveauregulierung ¹⁾	03.0520-3122.3	693122		22,20/229x42 TopKit	BDX
	2.1 TD (J633-635,63D)	65		01.91	11.92	- Niveauregulierung ²⁾					
	2.0 (J/- 636)	76		12.92	10.96	- ABS/ - Niveauregulierung ¹⁾	03.0520-2422.3	692422		22,20/229x42 TopKit	LUC
	2.1 TD (J633-635,63D)	65		12.92	10.96	- Niveauregulierung ²⁾					
	2.1 TD (J63E)	66		11.94	10.96	- Niveauregulierung ²⁾					
	2.2 (J/S637,J63G)	79		01.91	10.96	- ABS/ - Niveauregulierung ¹⁾					
2.2 4x4 (J/S637,J63G)	79		03.91	12.96	- ABS/ - Niveauregulierung ¹⁾						
	2.0 (J/- 636)	76		01.91	10.96	- ABS/ - Niveauregulierung ¹⁾	24.3727-1031.2	581031	1	L=1984/1045	
	2.1 RTDT Quadra	65		01.91	05.92	- Niveauregulierung ²⁾					
	2.1 TD (J633-635,63D)	65		01.91	10.96	- Niveauregulierung ²⁾					
	2.1 TD (J63E)	66		11.94	10.96	- Niveauregulierung ²⁾					
	2.2 (J/S637,J63G)	79		01.91	10.96	- ABS/ - Niveauregulierung ¹⁾					
	2.2 4x4 (J/S637,J63G)	79		03.91	12.96	- ABS/ - Niveauregulierung ¹⁾					
	2.0 (J/- 636)	76		01.91	10.96	+ ABS/ + Niveauregulierung ³⁾	24.3727-1024.2	581024	1	L=1285/1891	
	2.1 RTDT Quadra	65		01.91	05.92	+ Niveauregulierung ⁴⁾					
	2.1 TD (J633-635,63D)	65		01.91	10.96	+ Niveauregulierung ⁴⁾					
	2.1 TD (J63E)	66		11.94	10.96	+ Niveauregulierung ⁴⁾					
2.2 (J/S637,J63G)	79		01.91	10.96	+ ABS/ + Niveauregulierung ³⁾						
2.2 4x4 (J/S637,J63G)	79		03.91	12.96	+ ABS/ + Niveauregulierung ³⁾						
2.8 V6 (J638,J63J)	110		01.91	10.96							
	2.0 (J/- 636)	76		01.91	01.95		24.3728-1015.2	591015		L=1330	
	2.1 RTDT Quadra	65		01.91	05.92						
	2.1 TD (J633-635,63D)	65		01.91	01.95						
	2.1 TD (J63E)	66		11.94	01.95						
	2.2 (J/S637,J63G)	79		01.91	01.95						
	2.2 4x4 (J/S637,J63G)	79		03.91	01.95						
	2.0 (J/- 636)	76		02.95	10.96		24.3728-1026.2	591026		L=1318, + AUT	
	2.1 TD (J633-635,63D)	65		02.95	10.96						
	2.1 TD (J63E)	66		02.95	10.96						
	2.2 (J/S637,J63G)	79		02.95	10.96						
	2.2 4x4 (J/S637,J63G)	79		02.95	12.96						
					02.95	12.96					
RENAULT ESTAFETTE (R_) (69-80)											
	1.3 (R2136)	29		01.69	12.80		24.3222-1125.3	020356		Rz 22,20	
	1.3 (R2137)	29		01.69	12.80						
RENAULT FUEGO (80-92)											
	1.4 (R1360)			01.80	12.85	- (N)	03.2119-0781.3	010052		Thz 19,05	ATE
	1.6 (R1361)			01.83	12.85	- (N)					
	1.6 (R1362)			01.80	12.85		24.3541-1625.5	240045		D=54, - Halter	LUC
							24.3541-1626.5	240046		D=54, - Halter	LUC
	1.6 T (R1365)			01.84	12.85		24.3541-1625.5	240045		D=54, - Halter	LUC
	2.1 (R1366)			01.83	12.84		24.3541-1626.5	240046		D=54, - Halter	LUC
	1.4 (R1360)			01.80	12.85		13.0460-3911.2	603911		20905 18,0 +/WK	BDX
	1.6 (R1361)			01.83	12.85		13.0460-2834.2	602834		21463 18,0 /WK/S	LUC
	1.6 (R1362)			01.80	12.85		13.0460-0411.2	610411		Belagsatz-Zubehör	BDX
	2.0 (R1363)			01.81	12.85		13.0460-3911.2	603911		20905 18,0 +/WK	BDX
							13.0460-0411.2	610411		Belagsatz-Zubehör	BDX
	1.6 T (R1365)			01.84	12.85		13.0460-2834.2	602834		21463 18,0 /WK/S	LUC
2.1 (R1366)			01.83	12.84							
	1.6 (R1362)	0060851			12.85		24.0120-0148.1	420148		238 20,0 17,7 V	
	2.0 (R1363)	0046551			12.85						
	2.1 (R1366)		0003900	01.83							
	2.2 (R136B)	87		09.83	12.85						
	1.6 T (R1365)			01.84	12.85		24.0120-0126.1	420126		259 20,2 17,7 V +B	
	2.1 (R1366)		0003901		12.84						
	1.6 T (R1365)			01.84	12.85		13.0460-3961.2	603961		20336 14,0 +/WK	BDX
	1.6 T (R1365)			01.84	12.85		24.0112-0134.1	412134		254 12,0 10,5	
	1.4 (R1360)			01.80	12.85		24.5112-0220.3	330613	2	L=220	
	1.6 (R1361)			01.83	12.85						
	1.6 (R1362)			01.80	12.85						
	1.6 T (R1365)			01.84	12.85						
	2.0 (R1363)			01.82	12.85						
	2.1 (R1366)			01.83	12.84						

1) - ABS/ - suspens.level control / - ABS/ - correttore assetto / - ABS/ - correcteur d'assiette / - ABS/ - regul.alt.suspension
2) - suspension level control / - correttore assetto / - correcteur d'assiette / - regulacion altura suspension
3) + ABS/ + suspens.level control / + ABS/ + correttore d'assetto / + ABS/ + correcteur d'assiette / + ABS/ + regul.alt.suspension
4) + suspension level control / + correttore assetto / + correcteur d'assiette / + regulacion altura suspension



RENAULT FUEGO (80-92)											
	1.4 (R1360)		0059000	01.80			24.3222-1710.3	020112		Rz 22,20	BDX
	1.6 (R1361)		0006100	01.83			24.3222-1709.3	020111		Rz 22,20	BDX
							24.3222-1106.3	020261		Rz 22,20	LUC
	1.4 (R1360)		0059001	12.85			24.3222-1710.3	020112		Rz 22,20	BDX
	1.6 (R1361)		0006101	12.85			24.3222-1106.3	020261		Rz 22,20	LUC
							24.3222-1107.3	020262		Rz 22,20	LUC
	1.6 (R1362)			01.80	12.85		24.3222-1118.3	020315		Rz 22,20	BDX
	2.0 (R1363)			01.81	12.85						
	2.1 (R1366)			01.83	12.84						
	1.6 (R1362)			01.80	12.85		03.0137-0124.2	650124		229 x 42 HEB AUT	BDX
	2.0 (R1363)			01.81	12.85		03.0137-9020.2	669020		Bremsbacken-Zubehör	BDX
	2.1 (R1366)			01.83	12.84						
	1.6 (R1362)			01.80	12.85		03.0520-3122.3	693122		22,20/229x42 TopKit	BDX
	2.0 (R1363)			01.81	12.85						
	2.1 (R1366)			01.83	12.84						
RENAULT R4 (62-90)											
	0.8 (R1123)		1357385	01.71		+ (OK)	24.3120-1702.3	010467		Hz 20,64	
	0.8 (R1123)		1109666	01.71		+ (F)					
	0.8 (R1123)		1077042	01.71		+ (CH)					
	0.8 (R1123)		1006411	01.71		+ (N)					
	0.8 (R1123)		0765581	10.62							
	0.8 (R1123)	0765582			12.70	- (S)					
	0.8 (R1126)		0028263	01.72							
	0.8 (R2105)		0044278	01.65							
	0.8 (R2106)		0025949	01.66							
	0.8 (R2106)		0021494	01.66							
	0.8 (R1123)	1109667	1742851			+ (F)	24.3119-1702.3	010465		Hz 19,05	
	0.8 (R1123)	0765582	1077042			+ (S)					
	0.8 (R1126)	0028264	0469894			+ (F)					
	0.8 (R1129)			01.76	12.78						
	0.8 (R2106)	0042589	0082242			+ (S)					
	0.8 (R2391)		0002129	01.74							
	0.8 (R2392)		0005564	01.74							
	0.8 (R2430)		0001119	01.76							
	1.1 (R2370)		0056080	01.76		+ (D) (I) (RH)					
	1.1 (R2370)		0027449	01.76		+ (F) (A)					
1.1 (R2370)		0001660	01.76		+ (CH) (OK)						
	0.8 (R1123)		2159152	01.76			24.2120-1503.3	010397		THz 20,64	BDX
	0.8 (R1126)		0736614	01.76		+ (F) (S)					
	0.8 (R2106)		0279900	01.76							
	0.8 (R2109)	0223420	0372900			+ (F)					
	0.8 (R2391)	0002130	0006250								
	0.8 (R2392)	0005565	0011800								
	1.1 (R1128)		0121915	01.76							
	1.1 (R2370)		0027449	01.76		+ (CH) (OK) (N)					
	0.8 (R1123)	2159153			12.86		24.2120-1715.3	010469		THz 20,64	
	0.8 (R1123)	1951460			12.86						
	0.8 (R1126)	0736615			12.82	+ (F) (S)					
	0.8 (R2106)	0279901			12.86						
	0.8 (R2106)	0239871			12.86						
	0.8 (R2109)	0372901			12.82						
	0.8 (R2391)	0006251			12.82	+ (F)					
	0.8 (R2391)			01.83		12.86					
	0.8 (R2392)	0011801			12.82						
	1.1 (R1128)	0033060	0212750			+ (CH)					
	1.1 (R1128)	0121916	0212750								
	1.1 (R1128)	0033060	0212750			- (CH) (GB)	24.2120-1718.3	010491		THz 20,64	BDX
1.1 (R2370)	0086721	0168855			- (IL) (IS) (RH) (GB)						
	1.0 (R112C)			01.87	06.90		24.2119-1703.3	010323		THz 19,05	
	1.1 (R1128)	0461101			06.90	- (CH)					
	1.1 (R1128)	0212751			06.90	- (CH) (GB)					
	1.1 (R210B)	0025501			06.88						
	1.1 (R2370)	0168856			12.86	+ (D)					
	1.1 (R2370)	0361751			12.86	- (CH)					
	1.1 (R239B)	0002181			06.88						
	1.1 (S 128)			06.89	06.90						
	1.0 (R112C)			01.87	06.90		13.0460-3928.2	603928		20140 14,0 +/-WE	BDX
	1.1 (R1128)			01.83	06.90	+ (D)	13.0460-2967.2	602967		20480 15,5 /S	LUC
	1.1 (R2370)			01.83	12.86						
	1.1 (S 128)			06.89	06.90						
	1.1 (R210B)			01.83	06.88	- (D)	13.0460-3928.2	603928		20140 14,0 +/-WE	BDX
	1.1 (R239B)			01.83	06.88	- (D)					
	1.1 (R210B)			01.83	06.88	+ (D)	13.0460-2967.2	602967		20480 15,5 /S	LUC
	1.1 (R239B)			01.83	06.88	+ (D)					
	1.0 (R112C)			01.87	06.90		24.0110-0139.1	410139		228 10,0 9,0	
	1.1 (R1128)			01.83	06.90	+ (D)					
	1.1 (R210B)			01.83	06.88						
	1.1 (R2370)			01.83	12.86						
	1.1 (R239B)			01.83	06.88						
	1.1 (S 128)			06.89	06.90						

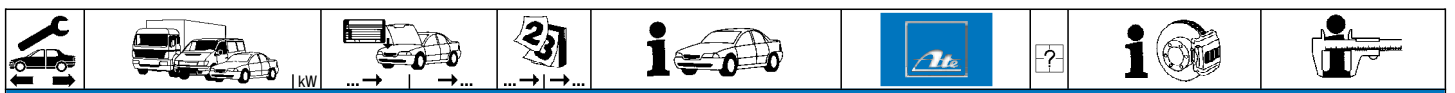





RENAULT R4 (62-90)

	1.0 (R112C) 1.1 (R1128) 1.1 (R210B) 1.1 (R2370) 1.1 (R239B) 1.1 (S 128)			01.87 01.83 01.83 01.83 01.83 06.89	06.90 06.90 + (D) 06.88 12.86 06.88 06.90	24.5115-0400.3	330413	2		L=400	
	0.8 (R1120) 0.8 (R1123) 0.8 (R1123) 0.8 (R1126) 0.8 (R1129) 0.8 (R2105) ◀ 0046235 0.8 (R2105) ▶ 0048235 0.8 (R2106) ◀ 0022627 0.8 (R2106) ▶ 0022289 0.8 (R2106) 0.8 (R2109) 0.8 (R2391) 0.8 (R2392) 0.8 (R2430) 1.1 (R1128) 1.1 (R1128) 1.1 (R2370)		0046244	01.67 10.62 01.76 01.76 01.76 01.76 12.75 12.75 12.75 01.76 01.72 01.74 01.74 01.76 01.78 01.83 01.76	12.71 12.75 + (N) (S) 12.86 12.82 + (F) 12.78 12.75 12.75 12.86 12.82 12.86 12.82 12.78 12.82 06.90 - (D) 12.86	24.3223-1101.3 24.3223-1102.3	020288 020289		Rz 23,81 Rz 23,81	BDX BDX	
	0.8 (R1120) 0.8 (R1123) 0.8 (R1123) 0.8 (R1126) 0.8 (R2105) 0.8 (R2106)			01.67 01.67 01.83 01.72 01.65 01.66	12.71 12.80 12.86 12.82 + (F) 12.71 12.71	03.0137-9028.2	669028			Bremsbacken-Zubehör	BDX
	0.8 (R1123) 0.8 (R1126) 0.8 (R1129) 0.8 (R2105) 0.8 (R2106) 0.8 (R2109) 0.8 (R2391) 0.8 (R2392) 0.8 (R2430) 1.1 (R1128) 1.1 (R2370)			01.81 01.72 01.76 01.72 01.72 01.76 01.74 01.74 01.76 01.78 01.76	12.82 12.76 + (S) 12.78 12.75 12.86 12.82 + (S) 12.86 12.82 + (F) 12.78 06.90 - (D) 12.86	03.0137-9020.2	669020	+ autom. Nachstellung ¹⁾	Bremsbacken-Zubehör	BDX	
	0.8 (R1120) 0.8 (R1123) 0.8 (R1123) 0.8 (R1126) 0.8 (R1126)	1226001	1229200 1112761 1077042	10.62 10.62 10.62 01.72 01.76	+ (CH) + (N) (S) - (CH) (N) (S) + (F)	24.3219-1101.3	020189		Rz 19,05	BDX	
	0.8 (R1120) 0.8 (R1123) 0.8 (R1126) 0.8 (R1129) 0.8 (R2105) 0.8 (R2106) 0.8 (R2106) 0.8 (R2109) 0.8 (R2391) 0.8 (R2392) 0.8 (R2430) 1.1 (R1128) 1.1 (R1128) 1.1 (R2370)	0621991 1077043 0007089 0002799 0002799	1226000 1379976 0137567 0002390 0056080	01.76 01.76 12.75 01.71 01.74 01.74 01.71 01.76 01.83 01.76	+ (S) + (S) 12.82 12.78 12.75 12.86 - (OK) (N) (S) 12.82 12.86 06.90 - (D) 12.82	24.3220-1101.3	020212		Rz 20,64	BDX	
	0.8 (R1123) 0.8 (R2106) 0.8 (R2430) 1.1 (R2370)	1379977 0137568 0002391 0056081		12.86 12.86 12.78 12.82	+ (S) + (OK) (N) (S)	24.3222-1101.3	020256		Rz 22,20	BDX	
	1.0 (R112C) 1.1 (R1128) 1.1 (R210B) 1.1 (R2370) 1.1 (R239B) 1.1 (S 128)			01.87 01.83 01.83 01.83 01.83 06.89	06.90 06.90 + (D) 06.88 12.86 06.88 06.90	24.3222-1101.3 24.3222-1103.3	020256 020258		Rz 22,20 Rz 22,20	BDX LUC	
	0.8 (R1120) 0.8 (R1123) 0.8 (R1129) 0.8 (R2106) 0.8 (R2430) 1.1 (R2370)		0000020 0001660	01.67 01.67 01.76 01.66 01.76 01.76	12.72 12.82 - (OK) (N) 12.78 12.82 12.82	03.0137-0082.2 03.0137-9031.2	650082 669031		180 x 32 Bremsbacken-Zubehör	BDX BDX	
	0.8 (R1123) 0.8 (R1126) 0.8 (R2105) 0.8 (R2106) 0.8 (R2109) 0.8 (R2391) 0.8 (R2392)			01.83 01.76 01.65 01.83 01.72 01.74 01.74	12.86 12.82 + (F) 12.75 06.87 12.82 + (F) 12.86 12.82	03.0137-9039.2	669039		Bremsbacken-Zubehör	BDX	
	0.8 (R1123) 0.8 (R1126) 0.8 (R2109)			01.76 01.76 01.72	12.82 + (OK) (N) 12.82 + (S) 12.82 + (S)	03.0137-9032.2	669032		Bremsbacken-Zubehör	BDX	

¹⁾ + automatic adjustment / + correzione automatica / + ajustage automatique / + reajuste automático



RENAULT R4 (62-90)												
	0.8 (R2430)		0000021			12.82			03.0137-9032.2	669032	Bremsbacken-Zubehör BDX	
	1.0 (R112C)				01.87	06.90						
	1.1 (R1128)				01.78	06.90						
	1.1 (R210B)				01.83	06.88						
	1.1 (R239B)				01.83	06.88						
	1.1 (S 128)				06.89	06.90						
	1.1 (R2370)		0001661			12.86			03.0137-9032.2	669032	Bremsbacken-Zubehör BDX	
	0.8 (R2430)		0002391			12.78			03.0520-0622.3	690622	22,20/180x32 TopKit BDX	
	1.1 (R2370)		0056081			12.82						
	1.0 (R112C)				01.87	06.90			03.0520-0622.3	690622	22,20/180x32 TopKit BDX	
	1.1 (R1128)				01.83	06.90						
	1.1 (R210B)				01.83	06.88						
	1.1 (R2370)				01.83	12.86						
	1.1 (R239B)				01.83	06.88						
	1.1 (S 128)				06.89	06.90						
	1.0 (R112C)				01.87	06.90			24.3727-1004.2	581004	2 ↓	L=1500
	1.1 (R1128)		0414670			06.90	- F					
	1.1 (R1128)		0390246			06.90	+ F					
	1.1 (R1128)				01.83	06.90						
1.1 (R210B)		0015201				06.88						
1.1 (R239B)		0000480				06.88						
1.1 (S 128)					06.89	06.90						

RENAULT R5 SUPER (85-96)											
	1.0 (B/C/S 400)				01.85	08.90			24.2117-1503.3	010400	Thz 17,46 BDX
	1.0 (B/C/S 400)				01.85	08.90			03.2119-3389.3	010057	Thz 19,05 ATE
	1.1 (B/C/- 40H)				06.87	08.90					
	1.1 (B/C/S 401)				01.85	03.95					
	1.2 (B/C/S 40F)				01.86	08.90					
	1.4 (-/C/- 405)				01.85	08.90					
	1.4 (B/C/- 402)				01.85	08.90					
	1.4 (B/C/- 403)				01.85	08.90					
	1.4 (B/C/- 407)				01.85	12.96					
	1.4 (B/C/- 40J)				06.87	08.90					
	1.4 (B/C/- 40M)				06.87	08.90					
	1.6 (B/C/S 404)				01.85	12.96					
	1.7 (-/C/- 409)				01.87	08.91					
	1.7 (B/C/- 408)				01.87	03.95					
	1.7 (B/C/- 40G)				06.87	03.95					
	1.7 (B/C/- 40K)				06.87	03.95					
		1.0 (B/C/S 400)				01.85	08.90			24.3451-1501.5	240263
1.1 (B/C/- 40H)					06.87	08.90			24.3451-1502.5	240264	D=45, - Halter BDX
1.1 (B/C/S 401)					01.85	03.95					
1.2 (-/I-S 40F)		J0002048			06.87				24.3481-1611.5	240029	D=48, - Halter LUC
1.2 (-/I-S 40F)		F0003023			06.87				24.3481-1612.5	240030	D=48, - Halter LUC
1.2 (-/C/- 40F)		F0041900			01.87				24.0101-4807.2	260053	Bremssattel-Zubehör LUC
1.2 (-/C/- 40F)		E0031616			01.87						
1.2 (-/C/- 40F)		A0014817			01.87						
1.2 (B/-/- 40F)		F0036138			01.86						
1.2 (B/-/- 40F)		E0022098			01.86						
1.2 (B/-/- 40F)		A0015020			01.86						
1.4 (-/C/- 402)		E0032423			01.85						
1.4 (-/C/- 403)		F0091886			01.85						
1.4 (-/C/- 403)		E0010323			01.85						
1.4 (-/C/- 407)		F0011863			01.85						
1.4 (-/C/- 40J)		F0002765			06.87						
1.4 (-/C/- 40M)		F0012574			06.87						
1.4 (B/-/- 402)		F0040540			01.85						
1.4 (B/-/- 402)		E0039388			01.85						
1.4 (B/-/- 403)		H0024395			01.85						
1.4 (B/-/- 403)		F0040959			01.85						
1.4 (B/-/- 403)		E0005420			01.85						
1.4 (B/-/- 407)		F0007769			01.86						
1.4 (B/-/- 40J)		H0000118			06.87						
1.4 (B/-/- 40J)		F0000321			06.87						
1.4 (B/-/- 40M)		H0000389			06.87						
1.4 (B/-/- 40M)		F0003205			06.87						
1.6 (-/I-S 404)		J0015987			01.85						
1.6 (-/I-S 404)	F0033520			01.85							
1.6 (-/C/- 404)	E0003969			01.85							
1.6 (B/-/- 404)	H0004300			01.86							
1.6 (B/-/- 404)	F0092729			01.86							
1.6 (B/-/- 404)	E0005191			01.86							
1.7 (-/C/- 408)	F0003232			01.87							
1.7 (B/-/- 408)	F0001836			01.87							
1.2 (-/I-S 40F)	F0003024				08.90			24.3481-1505.5	240047	D=48, - Halter BDX	
1.2 (-/I-S 40F)	J0002049				08.90			24.3481-1506.5	240048	D=48, - Halter BDX	
1.2 (-/C/- 40F)	A0014818				08.90	- E		24.3481-1611.5	240029	D=48, - Halter LUC	
1.2 (-/C/- 40F)	E0031617				08.90	- E		24.3481-1612.5	240030	D=48, - Halter LUC	
1.2 (-/C/- 40F)	F0041901				08.90	- E		24.0101-4803.2	260049	Bremssattel-Zubehör BDX	
1.2 (B/-/- 40F)	A0015021				08.90	- E		24.0101-4807.2	260053	Bremssattel-Zubehör LUC	
1.2 (B/-/- 40F)	E0022099				08.90	- E					
1.2 (B/-/- 40F)	F0036139				08.90	- E					
1.2 (B/C/- 40F)				01.86	08.90	+ E					
1.4 (-/C/- 402)	E0032424				06.89	- E	MA				
1.4 (-/C/- 403)	E0010324				08.90	- E	MA				

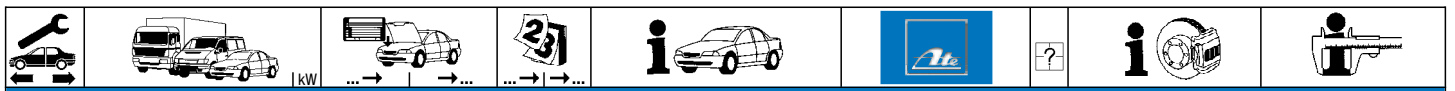

RENAULT R5 SUPER (85-96)

	1.4 (-/C/- 403)	F0091887	08.90	- E (MA)	24.3481-1505.5	240047		D=48, - Halter D=48, - Halter D=48, - Halter D=48, - Halter Bremsattel-Zubehör Bremsattel-Zubehör	BDX BDX LUC LUC BDX LUC	
	1.4 (-/C/- 407)	F0011864	12.96		24.3481-1506.5	240048				
	1.4 (-/C/- 40J)	F0002766	08.90		24.3481-1611.5	240029				
	1.4 (-/C/- 40M)	F0012575	08.90		24.3481-1612.5	240030				
	1.4 (B/-/- 402)	E0039389	08.90	- E	24.0101-4803.2	260049				
	1.4 (B/-/- 402)	F0040541	08.90	- E	24.0101-4807.2	260053				
	1.4 (B/-/- 403)	E0005421	08.90	- E						
	1.4 (B/-/- 403)	F0040960	08.90	- E						
	1.4 (B/-/- 403)	H0024396	08.90	- E						
	1.4 (B/-/- 407)	F0007770	12.96							
	1.4 (B/-/- 40J)	F0000322	08.90							
	1.4 (B/-/- 40J)	H0000119	08.90							
	1.4 (B/-/- 40M)	F0003206	08.90							
	1.4 (B/-/- 40M)	H0000390	08.90							
	1.4 (B/C/- 402)		01.85	08.90	+ E (MA)					
	1.4 (B/C/- 403)		01.85	08.90	+ E (MA)					
	1.6 (-/-/S 404)	F0033521	12.96	- E (MA)						
	1.6 (-/-/S 404)	J0015988	12.96	- E (MA)						
	1.6 (-/-/S 404)		01.85	12.96	+ E (MA)					
	1.6 (-/C/- 404)	E0003970	12.96	- E (MA)						
1.6 (B/-/- 404)	E0005292	12.96	- E							
1.6 (B/-/- 404)	F0092730	12.96	- E							
1.6 (B/-/- 404)	H0004301	12.96	- E							
1.6 (B/C/- 404)		01.85	12.96	+ E (MA)						
1.7 (-/C/- 408)	F0003233	03.95								
1.7 (B/-/- 408)	F0001837	03.95								
1.4 (-/C/- 405)		01.85	08.90		24.3481-1615.5	240031		D=48, - Halter D=48, - Halter Bremsattel-Zubehör	LUC LUC LUC	
1.7		06.87	03.95		24.3481-1616.5	240032				
1.7 (-/C/- 409)		01.87	08.91		24.0101-4806.2	260052				
1.7 (B/C/- 40G)		06.87	03.95							
1.7 (B/C/- 40K)		06.87	03.95							
	1.0 (B/C/S 400)		01.85	08.90	13.0460-3955.2	603955		21097 15,0 +/-WK	BDX	
	1.1 (B/C/- 40H)		06.87	08.90						
	1.1 (B/C/S 401)		01.85	03.95						
	1.2 (B/C/S 40F)		01.86	08.90	13.0460-3911.2	603911				
	1.4 (-/C/- 405)		01.85	08.90	13.0460-2834.2	602834				
	1.4 (B/C/- 402)		01.85	08.90	13.0460-0411.2	610411				
	1.4 (B/C/- 403)		01.85	08.90						
	1.4 (B/C/- 407)		01.85	12.96						
	1.4 (B/C/- 40J)		06.87	08.90						
	1.4 (B/C/- 40M)		06.87	08.90						
	1.6 (B/C/S 404)		01.86	12.96						
	1.7		06.87	03.95						
	1.7 (-/C/- 409)		01.87	08.91						
1.7 (B/C/- 408)		01.87	03.95							
1.7 (B/C/- 40G)		06.87	03.95							
1.7 (B/C/- 40K)		06.87	03.95							
	1.0 (B/C/S 400)		01.85	08.90	24.0108-0104.1	408104		238 8,2 7,0 +S +B		
	1.1 (B/C/- 40H)		06.87	08.90						
	1.1 (B/C/S 401)		01.85	03.95						
	1.2 (B/C/S 40F)		01.85	08.90	24.0112-0116.1	412116				
	1.4 (B/C/- 402)		01.85	08.90						
	1.4 (B/C/- 403)		01.85	08.90						
	1.4 (B/C/- 407)		01.85	12.96						
	1.4 (B/C/- 40J)		06.87	08.90						
	1.4 (B/C/- 40M)		06.87	08.90						
	1.6 (B/C/S 404)		01.85	12.96						
	1.7 (B/C/- 408)		01.87	03.95						
	1.4 (-/C/- 405)		01.85	08.90	24.0120-0125.1	420125				
	1.7		06.87	03.95						
1.7 (-/C/- 409)		01.87	08.91							
1.7 (B/C/- 40G)		06.87	03.95							
1.7 (B/C/- 40K)		06.87	03.95							
	1.0 (B/C/S 400)		01.85	08.90	24.5111-0300.3	330407		L=300		
	1.1 (B/C/- 40H)		06.87	08.90						
	1.1 (B/C/S 401)		01.85	03.95						
	1.2 (B/C/S 40F)		01.86	08.90						
	1.4 (-/C/- 405)		01.85	08.90						
	1.4 (B/C/- 402)		01.85	08.90						
	1.4 (B/C/- 403)		01.85	08.90						
	1.4 (B/C/- 407)		01.85	12.96						
	1.4 (B/C/- 40J)		06.87	08.90						
	1.4 (B/C/- 40M)		06.87	08.90						
	1.6 (B/C/S 404)		01.85	12.96						
	1.7 (-/C/- 409)		01.87	08.91						
	1.7 (B/C/- 408)		01.87	03.95						
1.7 (B/C/- 40G)		06.87	03.95							
1.7 (B/C/- 40K)		06.87	03.95							
	1.4 (-/C/- 405)		01.85	08.90	13.0460-3954.2	603954		20973 11,0 +	BDX	
	1.7		06.87	03.95						
	1.7 (-/C/- 409)		01.87	08.91						
	1.0 (B/C/S 400)		01.85	08.90	24.5229-0240.3	330400		L=242 L=285		
	1.1 (-/C/- 401)		01.85	08.90	24.5229-0285.3	330032				
	1.1 (B/-/S 401)		01.85	03.95						
	1.1 (B/C/- 40H)		06.87	08.90						
	1.2 (B/C/S 40F)		01.86	08.90						



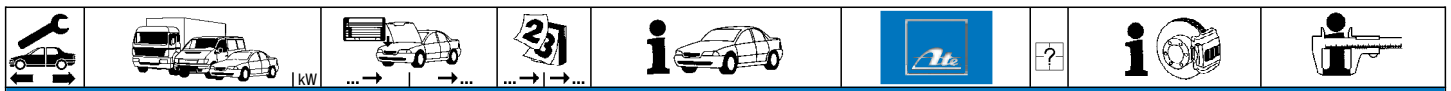

RENAULT R5 SUPER (85-96)

	1.4 (B/C/- 402)		01.85	08.90	+ (D)	24.5229-0240.3	330400			L=242		
	1.4 (B/C/- 403)		01.85	08.90		24.5229-0285.3	330032			L=285		
	1.4 (B/C/- 407)		01.85	12.96								
	1.4 (B/C/- 40J)		06.87	08.90								
	1.4 (B/C/- 40M)		06.87	08.90								
	1.6 (B/C/S 404)		01.85	12.96								
	1.7 (B/C/- 408)		01.87	03.95								
	1.7 (B/C/- 40G)		06.87	03.95								
	1.7 (B/C/- 40K)		06.87	03.95								
		1.1 (-/C/- 401)		01.85	03.95	- (D)	24.5229-0240.3	330400	2		L=242	
	1.4 (-/C/- 405)		01.85	08.90								
	1.4 (B/C/- 402)		01.85	08.90	- (D)							
	1.7 (-/C/- 409)		01.87	08.91								
	1.0 (B/C/S 400)		01.85	05.87	- (E) (MA)	24.3222-1709.3	020111			Rz 22,20	BDX	
	1.1 (B/C/S 401)		01.85	05.87	- (E) (MA)	24.3222-1710.3	020112			Rz 22,20	BDX	
	1.2 (B/-/- 40F)		06.87	08.90	- (E)							
	1.2 (B/C/S 40F)		01.86	05.87								
	1.4 (B/C/- 402)		01.85	05.87	- (E) (MA)							
	1.4 (B/C/- 403)		01.85	05.87	- (E) (MA)							
	1.4 (B/C/- 407)		01.85	05.87								
	1.6 (B/C/S 404)		01.86	05.87	- (E) (MA)							
	1.7 (B/C/- 408)		01.87	05.87								
		1.0 (B/C/- 400)		06.87	08.90		24.3220-1623.3	020353			RzR 20,64	BDX
	1.1 (B/C/- 401)		06.87	03.95		24.3220-1624.3	020354			RzR 20,64	BDX	
	1.1 (B/C/- 40H)		06.87	08.90								
	1.2 (-/C/S 40F)		06.87	08.90								
	1.2 (B/-/- 40F)		06.87	08.90	- (E)							
	1.4 (-/C/- 403)		06.87	08.90								
	1.4 (B/-/- 403)		06.87	08.90	- (E)							
	1.4 (B/C/- 402)		06.87	08.90								
	1.4 (B/C/- 407)		06.87	12.96								
	1.4 (B/C/- 40J)		06.87	08.90								
	1.4 (B/C/- 40M)		06.87	08.90								
	1.6 (-/C/S 404)		06.87	12.96								
	1.6 (B/-/- 404)		06.87	12.96	- (E)							
	1.7 (B/C/- 408)		06.87	03.95								
	1.7 (B/C/- 40K)		06.87	03.95								
	1.0 (-/C/- 400)	J0002661	01.85			24.3222-1106.3	020261			Rz 22,20	LUC	
	1.0 (-/C/- 400)	F0136026	01.85			24.3222-1107.3	020262			Rz 22,20	LUC	
	1.0 (-/C/- 400)	E0019232	01.85									
	1.0 (-/C/- 400)	A0004689	01.85									
	1.1 (-/C/- 401)	H0014971	01.85									
	1.1 (-/C/- 401)	F0241694	01.85									
	1.1 (-/C/- 401)	E0033906	01.85									
	1.1 (-/C/- 401)	A0026303	01.85									
	1.1 (B/-/- 401)	H0090813	01.85									
	1.1 (B/-/- 401)	F0141915	01.85									
	1.1 (B/-/- 401)	A0017137	01.85									
	1.2 (-/C/- 40F)	F0014301	01.87									
	1.2 (-/C/- 40F)	A0007044	01.87									
	1.2 (B/-/- 40F)	F0012819	01.86									
	1.2 (B/-/- 40F)	A0008584	01.86									
	1.4 (-/C/- 402)	H0017842	01.85									
	1.4 (-/C/- 402)	F0047933	01.85									
	1.4 (-/C/- 402)	E0004507	01.85									
	1.4 (-/C/- 403)	H0015774	01.85									
	1.4 (-/C/- 403)	F0074221	01.85									
	1.4 (-/C/- 407)	F0005257	01.85									
	1.4 (-/C/- 40J)	F0000958	06.87									
	1.4 (-/C/- 40M)	F0003838	06.87									
	1.4 (B/-/- 402)	H0018358	01.85									
	1.4 (B/-/- 402)	F0039701	01.85									
	1.4 (B/-/- 403)	H0018137	01.85									
	1.4 (B/-/- 403)	F0028155	01.85									
	1.4 (B/-/- 40J)	F0000136	06.87									
	1.4 (B/-/- 40M)	F0001177	06.87									
	1.6 (-/S 404)	J0009075	01.85									
	1.6 (-/S 404)	F0018026	01.85									
	1.6 (-/C/- 404)	F0021950	01.85									
	1.6 (B/-/- 404)	F0067508	01.86									
	1.7 (-/C/- 408)	F0001222	01.87									
	1.7 (-/C/- 40G)	F0007082	06.87									
	1.7 (-/C/- 40K)	F0001063	06.87									
	1.7 (B/-/- 408)	F0000958	01.87									
	1.7 (B/-/- 40G)	F0004650	06.87									
	1.7 (B/-/- 40K)	F0000015	06.87									
		1.0 (-/C/- 400)	A0004690	08.90			24.3220-1713.3	020410			RzR 20,64	LUC
		1.0 (-/C/- 400)	E0019233	08.90			24.3220-1714.3	020411			RzR 20,64	LUC
		1.0 (-/C/- 400)	F0136027	08.90								
		1.0 (-/C/- 400)	H0002281	08.90								
		1.0 (-/C/- 400)	J0002662	08.90								
		1.1 (-/C/- 401)	A0026304	03.95								
		1.1 (-/C/- 401)	E0033907	03.95								
		1.1 (-/C/- 401)	F0241695	03.95								
		1.1 (-/C/- 401)	J0017039	03.95								
		1.1 (B/-/- 401)	A0017138	03.95								
		1.1 (B/-/- 401)	F0141916	03.95								



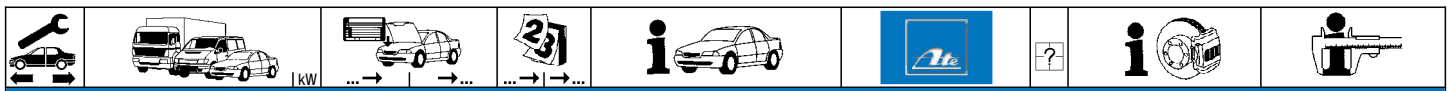

RENAULT R5 SUPER (85-96)

	1.1 (B/-/ 401) 1.2 (-/C/- 40F) 1.2 (-/C/- 40F) 1.2 (B/-/ 40F) 1.2 (B/-/ 40F) 1.4 (-/C/- 402) 1.4 (-/C/- 402) 1.4 (-/C/- 403) 1.4 (-/C/- 403) 1.4 (-/C/- 407) 1.4 (-/C/- 40J) 1.4 (-/C/- 40M) 1.4 (B/-/ 402) 1.4 (B/-/ 402) 1.4 (B/-/ 403) 1.4 (B/-/ 403) 1.4 (B/-/ 40J) 1.4 (B/-/ 40M) 1.6 (-/S 404) 1.6 (-/S 404) 1.6 (-/C/- 404) 1.6 (B/-/ 404) 1.6 (B/-/ 408) 1.7 (-/C/- 40G) 1.7 (-/C/- 40G) 1.7 (-/C/- 40K) 1.7 (B/-/ 408) 1.7 (B/-/ 40G) 1.7 (B/-/ 40K)	H0090814 A0007045 F0014302 A0008585 F0012820 E0004508 F0047934 F0074222 H0015775 F0005258 F0000959 F0003839 F0039702 H0018359 F0028156 H0018138 F0000137 F0001178 F0018027 J0009076 F0021951 F0067509 F0001223 F0007083 F0001064 F0000959 F0004651 F0000016	03.95 08.90 08.90 08.90 08.90 06.89 06.89 08.90 08.90 12.96 08.90 08.90 08.90 08.90 08.90 08.90 08.90 12.96 12.96 12.96 12.96 03.95 03.95 03.95 03.95 03.95 03.95	24.3220-1713.3 24.3220-1714.3	020410 020411		RzR 20,64 RzR 20,64	LUC LUC
	1.0 1.1 1.2 1.4 1.6 1.7	85	01.85 08.90 01.85 03.95 01.86 08.90 01.85 12.96 01.85 12.96 06.87 03.95	03.0137-0209.2 03.0137-0203.2 03.0137-0201.2 03.0137-9086.2 03.0137-9055.2 03.0137-9056.2	650209 650203 650201 669086 669055 669056	- autom. Nachstellung ¹⁾ + autom. Nachstellung ²⁾	180 x 42 180 x 42 AUT 180 x 41 HEB Bremsbacken-Zubehör Bremsbacken-Zubehör Bremsbacken-Zubehör	BDX BDX LUC BDX BDX LUC
	1.0 1.1 1.2 1.4 1.6 1.7	85	01.85 08.90 01.85 03.95 01.86 08.90 01.85 12.96 01.85 12.96 06.87 03.95	24.0218-0032.1 24.0218-0732.2	480118 480207		180/181 x 53,5 - Lager 180/181 x 53,2 + Lager	
	1.0 (B/C/S 400) 1.1 (B/C/S 401) 1.2 (B/C/S 40F) 1.4 (B/C/- 402) 1.4 (B/C/- 403) 1.4 (B/C/- 407) 1.6 (B/C/S 404)		01.85 06.86 01.85 06.86 01.86 06.86 01.85 06.86 01.85 06.86 01.85 06.86 01.86 06.86	- (E) MA - (E) MA - (E) MA - (E) MA - (E) MA - (E) MA	03.0520-0922.3	690922		22,20/180x42 TopKit BDX
	1.0 (B/C/S 400) 1.1 (B/C/S 401) 1.2 (B/-/ 40F) 1.2 (B/C/S 40F) 1.4 (B/C/- 402) 1.4 (B/C/- 403) 1.4 (B/C/- 407) 1.6 (B/C/S 404) 1.7 (B/C/- 408)		07.86 05.87 07.86 05.87 07.86 05.87 07.86 05.87 07.86 05.87 07.86 05.87 07.86 05.87 07.86 05.87 01.87 05.87	- (E) MA - (E) MA - (E) - (E) MA - (E) MA - (E) MA - (E) MA	03.0520-1022.3	691022		22,20/180x42 TopKit BDX
	1.0 (B/C/- 400) 1.1 (B/C/- 401) 1.1 (B/C/- 40H) 1.2 (-/C/S 40F) 1.2 (B/-/ 40F) 1.4 (-/C/- 403) 1.4 (B/-/ 403) 1.4 (B/C/- 402) 1.4 (B/C/- 407) 1.4 (B/C/- 40J) 1.4 (B/C/- 40M) 1.6 (-/C/S 404) 1.6 (B/-/ 404) 1.7 (B/C/- 408) 1.7 (B/C/- 40K)		06.87 08.90 06.87 03.95 06.87 08.90 06.87 08.90 06.87 08.90 06.87 08.90 06.87 08.90 06.87 08.90 06.87 12.96 06.87 08.90 06.87 08.90 06.87 12.96 06.87 12.96 06.87 03.95 06.87 03.95	- (E) - (E) - (E)	03.0420-1020.3 03.0520-1020.3	681020 691020		20,64/180x42 Kit 20,64/180x42 TopKit BDX BDX
	1.0 (-/C/- 400) 1.0 (-/C/- 400) 1.0 (-/C/- 400) 1.0 (-/C/- 400) 1.0 (-/C/- 400) 1.1 (-/C/- 401) 1.1 (-/C/- 401) 1.1 (-/C/- 401) 1.1 (-/C/- 401) 1.1 (-/C/- 401) 1.1 (B/-/ 401) 1.1 (B/-/ 401) 1.1 (B/-/ 401) 1.2 (-/C/- 40F) 1.2 (-/C/- 40F) 1.2 (B/-/ 40F) 1.2 (B/-/ 40F)	J0002661 H0002280 F0136026 E0019232 A0004689 H0014971 F0241694 E0033906 A0026303 H0090813 F0014915 A0017137 F0014301 A0007044 F0012819 A0008584	01.85 01.85 01.85 01.85 01.85 01.85 01.85 01.85 01.85 01.85 01.85 01.85 01.85 01.87 01.87 01.86 01.86		03.0520-1122.3	691122		22,20/180x41 TopKit LUC

¹⁾ - automatic adjustment / - correzione automatica / - ajustage automatique / - reajuste automatico

²⁾ + automatic adjustment / + correzione automatica / + ajustage automatique / + reajuste automático



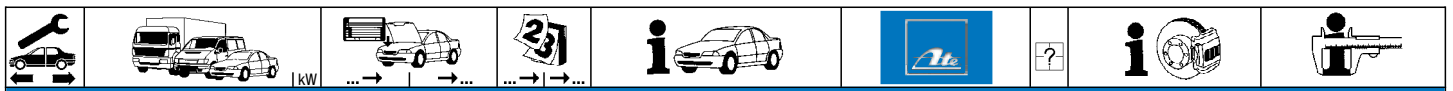

RENAULT R5 SUPER (85-96)























	1.0			01.85	08.90		24.3728-1006.2	591006		L=1050
	1.1			01.85	03.95					
	1.2			01.86	08.90					
	1.4		85	01.85	12.96					
	1.6			01.85	12.96					
	1.7			06.87	03.95					

RENAULT R5 (72-84)

	0.8 (R1220)			01.72	12.81	+ A F	24.3119-1702.3	010465		Hz 19,05
	0.8 (R1221)		0238423	01.73		+ L				
	0.8 (R1221)		0127674	01.73		+ D				
	0.8 (R1221)		0037964	01.73		+ B A (L) (NL)				
	0.8 (R1221)		0009569	01.73		+ (K)				
	0.8 (R1221)			01.73	12.84	+ (M) (S)				
	0.8 (R1220)			01.72	12.81	+ (M) (S)	24.2120-1503.3	010397		THz 20,64
	0.8 (R1221)	0238424	0280142			+ L				BDX
	0.8 (R1221)	0127676	0280142							
	1.0 (R1222)		1117921	01.72		+ L	24.3119-1703.3	010466		Hz 19,05
	1.0 (R1222)		0897764	01.72		+ D				
	1.0 (R1222)		0774925	01.72		+ F (M)				
	1.0 (R1222)		0574925	01.72		+ B (NL)				
	1.0 (R1222)		0173346	01.72		+ (K)				
	1.0 (R2382)		0008799	01.72		+ F (M)				
	1.1 (R1227)	0151059			12.84	+ (M)				
	0.8 (R1221)	0288143	0335200				24.2120-1715.3	010469		THz 20,64
	0.8 (R1391)	0009234	0051150							
	0.8 (R2381)	0020549	0038990							
	1.0 (R1222)	0574926	0775074			+ (M) (N)				
	1.0 (R1222)	1015701			12.84	+ D F A B (M)				
	1.0 (R2382)		0008799	01.76		+ (K)				
	1.0 (R2382)	0034296			12.84	- (K)				
	0.8 (R1221)	0335201			12.84		24.2119-1703.3	010323		THz 19,05
	0.8 (R1391)	0051151			12.84					
	0.8 (R2381)	0038991			12.84					
	1.0 (R1222)	1117922			12.84					
	1.0 (R1392)			01.80	12.84	- Bremsgerät 1)				
	1.1 (R1227)		0151058	01.80		+ (M)				
	1.1 (R1227)			01.80	12.84	- (M)				
	1.1 (R1397)			01.80	12.84					
	1.1 (R1397)			01.80	12.84					
	1.3 (R2387)			01.80	12.84					
	1.0 (R1222)	0897755	1015700			+ D	24.2120-1718.3	010491		THz 20,64
	1.0 (R1222)	0775075	1015700			+ F A (M) (N)				BDX
	1.0 (R1222)	0762309	1015700			+ (M)				
	1.0 (R1222)	0774926	1015700			+ L				
	1.0 (R1222)	0574926	1015700			+ B (L) (M)				
	1.0 (R2382)	0008800	0036295			+ F (K) (M)				
	1.0 (R2382)		0025883		01.72	+ B				
	1.0 (R1392)			01.80	12.84	+ Bremsgerät 2)	03.2119-0781.3	010052		THz 19,05
	1.1 (R1227)		0151058	01.80		+ (M)				ATE
	1.1 (R1227)			01.80	12.84	- (M)				
	1.1 (R1397)			01.80	12.84					
	1.3 (R1395)			01.80	12.84					
	1.3 (R2387)			01.80	12.84	+ Bremsgerät 2)				
	1.4 (R122B)			01.82	12.84					
	1.4 (R1399)			01.81	12.84	- (M)				
	0.8 (R1221)	0335201			12.84		13.0460-2967.2	602967		20480 15,5/S
	0.8 (R1391)	0051151			12.84					LUC
	0.8 (R2381)	0038981			12.84					
	1.0 (R1222)			01.72	12.84					
	1.1 (R1227)			01.80	12.84					
	1.3 (R1224)			01.76	12.84					
	1.3 (R1225)			01.76	12.84					
	1.3 (R2387)			01.80	12.84					
	1.4 (R1229)			01.80	12.84					
	1.0 (R1222)	1185269			12.84		13.0460-3928.2	603928		20140 14,0 +/WE
	1.0 (R1392)	0026816			12.84					BDX
	1.1 (R1227)	0411329			12.84					
	1.1 (R1397)	0503339			12.84					
	1.3 (R1224)	0497566			12.84					
	1.3 (R1225)	0399951			12.84					
	1.3 (R1395)	0048701			12.84					
	1.3 (R2387)	0052900			12.84					
	1.4 (R1229)	0083872			12.84					
	1.4 (R1399)	0026223			12.84					
	1.4 (R1223)			01.76	12.81		13.0460-3928.2	603928		20140 14,0 +/WE
	1.4 (R122B)			01.82	12.84					BDX
	0.8 (R1221)	0335201			12.84		24.0110-0139.1	410139		228 10,0 9,0
	0.8 (R1391)	0051151			12.84					
	0.8 (R2381)	0038981			12.84					
	1.0 (R1222)			01.72	12.84					
	1.0 (R1392)	0026816			12.84					
	1.1 (R1227)			01.80	12.84					
	1.1 (R1397)	0503339			12.84					
	1.3 (R1224)			01.76	12.84					
	1.3 (R1225)			01.76	12.84					
	1.3 (R1395)	0048701			12.84					

1) - booster unit / - servofreno / - servo-frein / - servofreno
 2) + booster unit / + servofreno / + servo-frein / + servofreno



RENAULT R5 (72-84)											
	1.3 (R2387) 1.4 (R1223) 1.4 (R1229) 1.4 (R122B) 1.4 (R1399) 1.4 (R8220)				01.80 01.76 01.80 01.82 12.84 01.80	12.84 12.81 12.84 12.84 12.84 12.84	24.0110-0139.1	410139		228 10,0 9,0	
	1.0 (R1222) 1.0 (R1392) 1.1 (R1227) 1.1 (R1397) 1.3 (R1224) 1.3 (R1225) 1.3 (R1395) 1.3 (R2387) 1.4 (R1223) 1.4 (R1229) 1.4 (R1399)				01.72 01.80 01.80 01.80 01.76 01.76 01.80 01.80 01.76 01.80 01.81	12.84 12.84 12.84 12.84 12.84 12.84 12.84 12.84 12.81 12.84 12.84	24.5115-0400.3	330413	2	L=400	
	0.8 (R1220) 0.8 (R1221) 0.8 (R1391) 0.8 (R2381)		0335200 0051150 0038980		01.72 01.73 01.80 01.78	12.81	24.3223-1101.3 24.3223-1102.3	020288 020289	 	Rz 23,81 Rz 23,81	BDX BDX
	0.8 (R1220) 0.8 (R1221) 0.8 (R1221) 0.8 (R2381)		0238423 0009569 0011591		01.72 01.73 01.73 01.78	12.81 - (S) - (OK) (N) (S) + (OK)	03.0137-9028.2	669028		Bremsbacken-Zubehör	BDX
	0.8 (R1220) 0.8 (R1221) 0.8 (R1221) 0.8 (R1391) 0.8 (R2381)	0238424 0009570	0335200 0335200 0335200 0051150 0038980		01.72 12.81 12.81 01.73 01.80	+ (S) - (OK) (N) (S) + (OK) + (N) (S)	03.0137-9020.2	669020	+ autom. Nachstellung ¹⁾	Bremsbacken-Zubehör	BDX
	1.4 (R122B)				01.82	12.84	24.0110-0139.1	410139		228 10,0 9,0	
	0.8 (R1220) 0.8 (R1221) 0.8 (R2381)		0118673 0238423 0011591		01.72 01.73 01.78		24.3219-1101.3	020189		Rz 19,05	BDX
	0.8 (R1220) 0.8 (R1221) 0.8 (R1391) 0.8 (R2381)	0118674 0238424	0335200 0051150 0038980		12.81 01.80		24.3220-1101.3	020212		Rz 20,64	BDX
	0.8 (R1221) 0.8 (R1391) 0.8 (R2381)	0335201 0051151 0038981			12.84 12.84 12.84		24.3222-1101.3	020256		Rz 22,20	BDX
	1.0 (R1222) 1.0 (R1392) 1.1 (R1227) 1.1 (R1397) 1.3 (R1224) 1.3 (R1225) 1.3 (R1395) 1.4 (R1229) 1.4 (R1399)				01.72 01.80 01.80 01.80 01.74 01.76 01.80 01.80 01.81	12.84 12.84 12.84 12.84 12.84 12.84 12.84 12.84 12.84	24.3222-1101.3 24.3222-1103.3	020256 020258		Rz 22,20 Rz 22,20	BDX LUC
	1.3 (R2387)				01.80	12.84	24.3222-1103.3	020258		Rz 22,20	LUC
	0.8 (R1220) 0.8 (R1221) 0.8 (R1391) 0.8 (R2381)		0335200 0051150 0038980		01.72 01.73 01.80 01.78	12.81 - (S)	03.0137-9039.2	669039		Bremsbacken-Zubehör	BDX
	0.8 (R1220)				01.72	12.81 + (S)	03.0137-9032.2	669032		Bremsbacken-Zubehör	BDX
	0.8 (R1221) 0.8 (R1391) 0.8 (R2381)	0009570 0051151 0038981	0360620 0062540 0044870		01.72 01.80 01.80		03.0137-0082.2 03.0137-9031.2	650082 669031		180 x 32 Bremsbacken-Zubehör	BDX BDX
	1.0 (R1222) 1.0 (R1392) 1.1 (R1227) 1.1 (R1397)		1197930 0032000 0502120 0637940		01.72 01.80 01.80 01.80						
	1.3 (R1224) 1.3 (R1225) 1.3 (R1395)		0409290 0400600 0049300		01.74 01.76 01.80						
	1.3 (R2387) 1.4 (R1229) 1.4 (R1399)		0073140 0133890 0040100		01.80 01.80 01.81						
	0.8 (R1221) 0.8 (R1391) 0.8 (R2381)	0360621 0062541 0044871			12.84 12.84 12.84		03.0137-9032.2	669032		Bremsbacken-Zubehör	BDX
	1.0 (R1222) 1.0 (R1392) 1.1 (R1227) 1.1 (R1397)	1197931 0032001 0502121 0637941			12.84 12.84 12.84 12.84						
	1.3 (R1224) 1.3 (R1225) 1.3 (R1395)	0409291 0400601 0049301			12.84 12.84 12.84						
	1.3 (R2387) 1.4 (R1229) 1.4 (R1399)	0073141 0133891 0040101			12.84 12.84 12.84						

¹⁾ + automatic adjustment / + correzione automatica / + ajustage automatique / + reajuste automático



RENAULT R5 (72-84)

	0.8 (R1221) 0.8 (R1391) 0.8 (R2381)	0360621 0062541 0044871		12.84 12.84 12.84		03.0520-0622.3	690622		22,20/180x32 TopKit	BDX
	1.0 (R1222) 1.0 (R1392) 1.1 (R1227) 1.1 (R1397) 1.3 (R1224) 1.3 (R1225) 1.3 (R1395) 1.4 (R1229) 1.4 (R1399)	1197931 0032001 0502121 0637941 0409291 0400601 0049301 0133891 0040101		12.84 12.84 12.84 12.84 12.84 12.84 12.84 12.84 12.84		03.0520-0622.3	690622		22,20/180x32 TopKit	BDX
	0.8 (R1220) 0.8 (R1221) 0.8 (R1391) 0.8 (R2381) 1.0 (R1222) 1.0 (R1392) 1.1 (R1227) 1.1 (R1397) 1.3 (R1224) 1.3 (R1225) 1.3 (R1395) 1.3 (R2387) 1.4 (R1223) 1.4 (R1229) 1.4 (R122B) 1.4 (R1399) 1.4 (R8220)			01.72 12.81 01.73 12.84 01.80 12.84 01.78 12.84 01.72 12.84 01.80 12.84 01.80 12.84 01.80 12.84 01.76 12.84 01.76 12.84 01.80 12.84 01.80 12.84 01.76 12.81 01.80 12.84 01.82 12.84 01.81 12.84 01.80 12.84		24.3727-1004.2	581004	<input type="checkbox"/>	L=1500	

RENAULT R6 (69-80)















	0.8 (R1180) 0.8 (R1180) 0.8 (R1180) 0.8 (R1180) 0.8 (R1180) 0.8 (R1180) 0.8 (R1180)	0325727 0244979 0325727 0581127	0581126 0555819 0439661 0325726 0244978	01.76 01.76 01.69	+ D + F MA + OK + S - OK + A + I GB FN	24.3119-1702.3	010465		Hz 19,05	
	0.8 (ACL1A) Rodeo 0.8 (R1180) 1.1 (R1181) 1.1 (R1181) 1.1 (R1181) 1.1 (R1181) 1.1 (R1181)	0222715		12.80 12.80 01.70 01.70 01.70 01.76	12.80 12.80 + CH S + OK + N - OK CH S N + GB MA P FN	24.2120-1503.3	010397		THz 20,64	BDX
	1.1 (R1181)		0433930 0337811 0050697	01.70 01.70 01.70 01.76	12.80 12.80 + CH S + OK + N - OK CH S N + GB MA P FN	24.3119-1703.3	010466		Hz 19,05	
	1.1 (R1181)			01.70	12.80	24.2120-1715.3	010469		THz 20,64	
	1.1 (R1181)			01.70	12.80	13.0460-3928.2	603928		20140 14,0 +/-WE	BDX
	1.1 (R1181)			01.70	12.80	24.0110-0139.1	410139		228 10,0 9,0	
	0.8 (ACL1A) Rodeo 0.8 (R1180)			01.71 01.69	12.80 12.80	24.3223-1101.3 24.3223-1102.3	020288 020289	<input type="checkbox"/> <input type="checkbox"/>	Rz 23,81 Rz 23,81	BDX BDX
	0.8 (ACL1A) Rodeo 0.8 (R1180) 0.8 (R1180)	0455168	0455167	01.71 01.69 01.69	12.80 12.80 + OK - OK	24.3220-1101.3	020212		Rz 20,64	BDX
	0.8 (R1180) 1.1 (R1181)			12.75 12.80	+ OK	24.3222-1101.3	020256		Rz 22,20	BDX
	0.8 (R1180) 1.1 (R1181)		0555819	01.69 01.76	+ CH	03.0137-0082.2 03.0137-9031.2	650082 669031		180 x 32 Bremsbacken-Zubehör	BDX BDX
	0.8 (R1180)	0439662	0555819	01.69	+ OK	03.0137-9032.2	669032		Bremsbacken-Zubehör	BDX
	0.8 (R1180)	0455168		01.69	12.80	03.0137-9039.2	669039		Bremsbacken-Zubehör	BDX
	0.8 (R1180)				12.80 + OK	03.0520-0622.3	690622		22,20/180x32 TopKit	BDX













RENAULT R9 (82-89)

	1.1 (L421) 1.2 (L42S) 1.4 (L422) 1.4 (L423) 1.4 (L423) 1.4 (L423) 1.4 (L42C) 1.4 (L42R) 1.4 i (L42A) 1.4 T (L425) 1.6 (L424) 1.7 (L42D) 1.7 (L42L) 1.7 (L42N) 1.7 i (L42E)	35 40 44 44 44 44 44 49 44 44 40 55 65 69		01.82 06.87 10.86 11.89 01.82 12.86 01.82 09.86 01.82 09.86 10.86 11.89 10.86 11.89 10.86 11.89 06.87 11.89 01.85 11.89 01.83 11.89 06.87 11.89 10.86 11.89 10.86 11.89 10.86 11.89	- E + Schaltgetriebe 1) + Klimaanlage/ + Automatikgetr. 2) - E - E	03.2119-1281.3	010054		THz 19,05	ATE
--	--	--	--	---	--	----------------	--------	--	-----------	-----

1) + manual transmission / + scatola cambio velocità / + transmission mécanique / + cambio de velocidad
2) + air conditioning/+autom.transm. / + aria condizionata/+scatola camb.autom. / + air conditionné / + transm.automatique / + aire acondicionado/ + camb.automático























RENAULT R9 (82-89)											
	1.7 i (L42F)	54		01.85	11.89	03.2119-1281.3	010054			THz 19,05	ATE
	1.4 T (L425)			01.85	11.89	03.2119-3389.3	010057			THz 19,05	ATE
	1.2 (L42S)	40		01.86	11.89	24.3481-1611.5	240029			D=48, - Halter	LUC
	1.4 (L422)	44		01.82	12.86	24.3481-1612.5	240030			D=48, - Halter	LUC
	1.4 (L423)			01.82	11.89	24.0101-4807.2	260053			Bremssattel-Zubehör	LUC
	1.4 (L42C)	44		10.86	11.89						
	1.4 (L42R)	49		10.86	11.89						
	1.4 i (L42A)			06.87	11.89						
	1.6 (L424)	40		01.83	11.89						
	1.7 (L426)	59		01.85	06.87						
	1.7 (L42L)	55		10.86	11.89						
	1.7 i (L42F)	54		01.85	11.89						
	1.4 T (L425)			01.85	11.89	24.3481-1615.5	240031			D=48, - Halter	LUC
	1.7 (L42D)			06.87	11.89	24.3481-1616.5	240032			D=48, - Halter	LUC
	1.7 (L42N)	65		10.86	11.89	24.0101-4806.2	260052			Bremssattel-Zubehör	LUC
	1.7 i (L42E)	69		10.86	11.89						
	1.1 (L421)	35		01.82	06.87	13.0460-3911.2	603911			20905 18,0 +/WK	BDX
	1.2 (L42S)	40		01.86	11.89	13.0460-2834.2	602834			21463 18,0 /WK/S	LUC
	1.4 (L422)	44		01.82	12.86	13.0460-0411.2	610411			Belagsatz-Zubehör	BDX
	1.4 (L423)			01.82	11.89						
	1.4 (L42C)	44		10.86	11.89						
	1.4 (L42R)	49		10.86	11.89						
	1.4 i (L42A)			06.87	11.89						
	1.6 (L424)	40		01.83	11.89						
	1.7 (L426)	59		01.85	06.87						
	1.7 (L42L)	55		10.86	11.89						
	1.7 i (L42F)	54		01.85	11.89						
	1.4 T (L425)			01.85	11.89	13.0460-2834.2	602834			21463 18,0 /WK/S	LUC
	1.7 (L42D)			06.87	11.89						
	1.7 (L42N)	65		10.86	11.89						
	1.7 i (L42E)	69		10.86	11.89						
	1.1 (L421)	35	0084201	01.82	06.87	24.0112-0116.1	412116			238 12,0 10,5 +S +B	
	1.2 (L42S)	40		01.86	11.89						
	1.4 (L422)	44	0170421		12.86						
	1.4 (L423)			01.82	11.89						
	1.4 (L42C)	44		10.86	11.89						
	1.4 (L42R)	49		10.86	11.89						
	1.4 i (L42A)			06.87	11.89						
	1.6 (L424)	40		01.83	11.89						
	1.7 (L426)	59		01.85	06.87						
	1.7 (L42L)	55		10.86	11.89						
	1.7 i (L42F)	54		01.85	11.89						
	1.4 T (L425)			01.85	11.89	24.0120-0125.1	420125			238 20,1 17,7 V +S +B	
	1.7 (L42D)			06.87	11.89						
	1.7 (L42N)	65		10.86	11.89						
	1.7 i (L42E)	69		10.86	11.89						
	1.1 (L421)	35		01.82	06.87	24.5111-0345.3	330406	2		L=345	
	1.2 (L42S)	40		01.86	11.89						
	1.4 (L422)	44		01.82	12.86						
	1.4 (L423)			01.82	11.89						
	1.4 (L42C)	44		10.86	11.89						
	1.4 (L42R)	49		10.86	11.89						
	1.4 i (L42A)			06.87	11.89						
	1.4 T (L425)			01.85	11.89						
	1.6 (L424)	40		01.83	11.89						
	1.7 (L426)	59		01.85	06.87						
	1.7 (L42D)			06.87	11.89						
	1.7 (L42L)	55		10.86	11.89						
	1.7 (L42N)	65		10.86	11.89						
	1.7 i (L42E)	69		10.86	11.89						
	1.7 i (L42F)	54		01.85	11.89						
	1.4 T (L425)			10.86	11.89	13.0460-3954.2	603954			20973 11,0 +	BDX
	1.1 (L421)	35		01.82	06.87	24.5229-0240.3	330400	2		L=242	
	1.2 (L42S)	40		01.86	11.89						
	1.4 (L422)	44		01.82	12.86						
	1.4 (L423)			01.82	11.89						
	1.4 (L42C)	44		10.86	11.89						
	1.4 (L42R)	49		10.86	11.89						
	1.4 i (L42A)			06.87	11.89						
	1.4 T (L425)			01.85	11.89						
	1.6 (L424)	40		01.83	11.89						
	1.7 (L426)	59		01.85	06.87						
	1.7 (L42D)			06.87	11.89						
	1.7 (L42L)	55		10.86	11.89						
	1.7 (L42N)	65		10.86	11.89						
	1.7 i (L42E)	69		10.86	11.89						
	1.7 i (L42F)	54		01.85	11.89						
	1.1 (L421)	35		10.86	06.87	24.3222-1709.3	020111			Rz 22,20	BDX
						24.3222-1710.3	020112			Rz 22,20	BDX













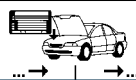















RENAULT R9 (82-89)		RENAULT R11 (83-89)				
	1.2 (L42S) 40 1.2 (L42S) 40 1.4 (L422) 44 1.4 (L423) 40 1.4 (L423) 40 1.6 (L424) 40 1.6 (L424) 40 1.7 (L426) 59 1.7 i (L42F) 54	01.86 09.86 - E 01.86 11.89 + E 01.82 12.86 01.82 09.86 - E 01.82 11.89 + E 01.83 09.86 - E 01.83 11.89 + E 01.85 09.86 01.85 09.86	24.3222-1709.3 020111 24.3222-1710.3 020112 24.3222-1106.3 020261 24.3222-1107.3 020262	 	Rz 22,20 Rz 22,20 Rz 22,20 Rz 22,20	BDX BDX LUC LUC
	1.2 (L42S) 40 1.4 (L423) 44 1.4 (L42C) 44 1.4 (L42R) 49 1.4 i (L42A) 40 1.6 (L424) 40 1.7 (L426) 59 1.7 (L42D) 59 1.7 (L42N) 65 1.7 i (L42E) 69 1.7 i (L42F) 54	10.86 11.89 - E 10.86 11.89 - E 10.86 11.89 10.86 11.89 06.87 11.89 10.86 11.89 - E 10.86 06.87 06.87 11.89 10.86 11.89 10.86 11.89 10.86 11.89	24.3220-1603.3 020230 24.3220-1604.3 020231 24.3222-1106.3 020261 24.3222-1107.3 020262	   	RzR 20,64 RzR 20,64 Rz 22,20 Rz 22,20	BDX BDX LUC LUC
	1.1 (L421) 35 1.2 (L42S) 40 1.4 (L422) 44 1.4 (L423) 44 1.4 (L42C) 44 1.4 (L42R) 49 1.4 i (L42A) 40 1.6 (L424) 40 1.7 (L426) 59 1.7 (L42D) 55 1.7 (L42L) 69 1.7 i (L42E) 69 1.7 i (L42F) 54	01.82 06.87 01.86 11.89 01.82 12.86 01.82 11.89 10.86 11.89 10.86 11.89 06.87 11.89 01.83 11.89 01.85 06.87 06.87 11.89 10.86 11.89 10.86 11.89 01.85 11.89	03.0137-0209.2 650209 03.0137-0203.2 650203 03.0137-0201.2 650201 03.0137-9086.2 669086 03.0137-9055.2 669055 03.0137-9056.2 669056	- autom. Nachstellung ¹⁾ + autom. Nachstellung ²⁾	180 x 42 180 x 42 AUT 180 x 41 HEB Bremsbacken-Zubehör Bremsbacken-Zubehör Bremsbacken-Zubehör	BDX BDX LUC BDX BDX LUC
	1.1 (L421) 35 1.2 (L42S) 40 1.4 (L422) 44 1.4 (L423) 44 1.4 (L42C) 44 1.4 (L42R) 49 1.4 i (L42A) 40 1.6 (L424) 40 1.7 (L426) 59 1.7 (L42D) 55 1.7 (L42L) 69 1.7 i (L42E) 69 1.7 i (L42F) 54	01.82 06.87 01.86 11.89 01.82 12.86 01.82 11.89 10.86 11.89 10.86 11.89 06.87 11.89 01.83 11.89 01.85 06.87 06.87 11.89 10.86 11.89 10.86 11.89 01.85 11.89	24.0218-0032.1 480118 24.0218-0732.2 480207		180/181 x 53,5 - Lager 180/181 x 53,2 + Lager	
	1.1 (L421) 35 1.1 (L421) 35 1.2 (L42S) 40 1.4 (L422) 44 1.4 (L423) 40 1.6 (L424) 40 1.7 (L426) 59 1.7 i (L42F) 54	01.82 09.86 10.86 06.87 01.86 09.86 01.82 12.86 01.82 09.86 01.83 09.86 01.85 09.86 01.85 09.86	03.0520-1117.3 691117 03.0520-0922.3 690922 03.0520-0922.3 690922 03.0520-1122.3 691122	+ autom. Nachstellung ²⁾ + autom. Nachstellung ²⁾	17,46/180x42 TopKit 22,20/180x42 TopKit 22,20/180x42 TopKit 22,20/180x41 TopKit	BDX BDX BDX LUC
	1.2 (L42S) 40 1.4 (L423) 44 1.4 (L42C) 44 1.4 (L42R) 49 1.4 i (L42A) 40 1.6 (L424) 40 1.7 (L426) 59 1.7 (L42D) 65 1.7 (L42N) 69 1.7 i (L42E) 69 1.7 i (L42F) 54	10.86 11.89 10.86 11.89 10.86 11.89 10.86 11.89 06.87 11.89 10.86 11.89 10.86 06.87 06.87 11.89 10.86 11.89 10.86 11.89 10.86 11.89	03.0520-0920.3 690920 03.0520-1122.3 691122		20,64/180x42 TopKit 22,20/180x41 TopKit	BDX LUC
RENAULT R11 (83-89)						
	1.1 (B/C/S 371) 35 1.2 (B/-/ 37S) 40 1.4 (-/ /S 373) ▶ 44 1.4 (B/C/ 372) ▶ 44 1.4 (B/C/ 373) ▶ 44 1.4 (B/C/ 373) ▶ 44 1.4 (B/C/ 373) ▶ 44 1.4 (B/C/ 37C) 44 1.4 (B/C/ 37R) 49 1.4 i (B/C/ 37A) 49 1.4 T (-/C/ 375) 44 1.4 T (B/-/ 375) 44 1.6 D (-/C/ 374) 40 1.6 D (B/-/ 374) 40 1.7 (B/-/ 376) 59 1.7 (B/-/ 37N) 65 1.7 (B/C/ 37D) 64 1.7 (B/C/ 37L) 54 1.7 i (B/C/ 37E) 69	01.83 06.87 10.86 11.89 01.85 09.86 01.83 12.86 01.83 09.86 01.83 09.86 + Klimaanlage/ + Automatikgetr. ³⁾ 10.86 11.89 - E 10.86 11.89 10.86 11.89 06.87 11.89 01.84 11.89 - E 01.84 11.89 01.84 11.89 01.84 11.89 - E (GB) 01.84 11.89 - E (GB) 10.86 11.89 06.87 11.89 10.86 11.89 10.86 11.89	03.2119-1281.3 010054		Thz 19,05	ATE

¹⁾ - automatic adjustment / - correzione automatica / - ajustage automatique / - reajuste automatico

²⁾ + automatic adjustment / + correzione automatica / + ajustage automatique / + reajuste automatico

³⁾ + air conditioning/ + autom.transm. / + aria condizionata/ + scatola camb.autom. / + air conditionné/ + transm.automatique / + aire acondicionado/ + camb.automático

								
RENAULT R11 (83-89)								
	1.7 i (B/C/- 37F)	55		01.85 11.89	03.2119-1281.3	010054		THz 19,05 ATE
	1.4 T (B/C/- 37S)			01.84 11.89	03.2119-3389.3	010057		THz 19,05 ATE
	1.1 (-/-/S 371)	35		01.84 10.86	24.3481-1611.5	240029		D=48, - Halter LUC
	1.1 (B/C/- 371)	35		01.83 06.87	24.3481-1612.5	240030		D=48, - Halter LUC
	1.2 (B/C/S 37S)	40		01.86 11.89	24.0101-4807.2	260053		Bremssattel-Zubehör LUC
	1.4 (-/-/S 373)			01.85 10.86				
	1.4 (B/C/- 372)	44		01.83 12.86				
	1.4 (B/C/- 373)			01.83 11.89				
	1.4 (B/C/- 37C)	44		10.86 11.89				
	1.4 (B/C/- 37R)	49		06.87 11.89				
	1.4 i (B/C/- 37A)			06.87 11.89				
	1.6 D (B/C/S 374)	40		01.84 11.89				
	1.7 (B/C/- 376)	59		01.84 11.89				
	1.7 (B/C/- 37L)	54		10.86 11.89				
	1.7 i (B/C/- 37F)	55		01.85 11.89				
	1.4 T (B/-/- 375)			01.84 11.89	24.3481-1615.5	240031		D=48, - Halter LUC
	1.4 T (B/C/- 375)			01.84 11.89	24.3481-1616.5	240032		D=48, - Halter LUC
	1.7 (B/C/- 37D)	64		06.87 11.89	24.0101-4806.2	260052		Bremssattel-Zubehör LUC
	1.7 (B/C/- 37N)	65		10.86 11.89				
	1.7 i (B/C/- 37E)	69		10.86 11.89				
	1.1 (-/-/S 371)	35		01.84 10.86	13.0460-3911.2	603911		20905 18,0 +/WK BDX
	1.1 (B/C/- 371)	35		01.83 06.87	13.0460-2834.2	602834		21463 18,0 /WK/S LUC
	1.2 (B/C/S 37S)	40		01.86 11.89	13.0460-0411.2	610411		Belagsatz-Zubehör BDX
	1.4 (-/-/S 373)			01.85 10.86				
	1.4 (B/C/- 372)	44		01.83 12.86				
	1.4 (B/C/- 373)			01.83 11.89				
	1.4 (B/C/- 37C)	44		10.86 11.89				
	1.4 (B/C/- 37R)	49		06.87 11.89				
	1.4 i (B/C/- 37A)			06.87 11.89				
	1.6 D (B/C/S 374)	40		01.84 11.89				
	1.7 (B/C/- 376)	59		01.84 06.87				
	1.7 (B/C/- 37L)	54		10.86 11.89				
	1.7 i (B/C/- 37F)	55		01.85 11.89				
	1.4 T (B/C/- 375)	64		01.84 11.89	13.0460-2834.2	602834		21463 18,0 /WK/S LUC
	1.7 (B/C/- 37D)	65		06.87 11.89				
	1.7 (B/C/- 37N)	65		10.86 11.89				
	1.7 i (B/C/- 37E)	69		10.86 11.89				
	1.1 (-/-/S 371)	35		01.84 10.86	24.0112-0116.1	412116		238 12,0 10,5 +S +B
	1.1 (B/C/- 371)	35		01.83 06.87				
	1.2 (B/C/S 37S)	40		01.86 11.89				
	1.4 (-/-/S 373)			01.85 10.86				
	1.4 (B/C/- 372)	44		01.83 12.86				
	1.4 (B/C/- 373)			01.83 11.89				
	1.4 (B/C/- 37C)	44		10.86 11.89				
	1.4 (B/C/- 37R)	49		06.87 11.89				
	1.4 i (B/C/- 37A)			06.87 11.89				
	1.6 D (B/C/S 374)	40		01.84 11.89				
	1.7 (B/C/- 376)	59		01.84 06.87				
	1.7 (B/C/- 37L)	54		10.86 11.89				
	1.7 i (B/C/- 37F)	55		01.85 11.89				
	1.4 T (B/C/- 375)	64		01.84 11.89	24.0120-0125.1	420125		238 20,1 17,7 V +S +B
	1.7 (B/C/- 37D)	65		06.87 11.89				
	1.7 (B/C/- 37N)	65		10.86 11.89				
	1.7 i (B/C/- 37E)	69		10.86 11.89				
	1.1 (-/-/S 371)	35		01.84 10.86	24.5111-0345.3	330406	2	L=345
	1.1 (B/C/- 371)	35		01.83 06.87				
	1.2 (B/C/S 37S)	40		01.86 11.89				
	1.4 (-/-/S 373)			01.85 10.86				
	1.4 (B/C/- 372)	44		01.83 12.86				
	1.4 (B/C/- 373)			01.83 11.89				
	1.4 (B/C/- 37C)	44		10.86 11.89				
	1.4 (B/C/- 37R)	49		06.87 11.89				
	1.4 i (B/C/- 37A)			06.87 11.89				
	1.4 T (B/C/- 375)	40		01.84 11.89				
	1.6 D (B/C/S 374)	40		01.84 11.89				
	1.7 (B/C/- 376)	59		01.84 06.87				
	1.7 (B/C/- 37D)	64		06.87 11.89				
	1.7 (B/C/- 37N)	65		10.86 11.89				
	1.7 i (B/C/- 37E)	69		10.86 11.89				
	1.4 T (B/C/- 375)			10.86 11.89	13.0460-3954.2	603954		20973 11,0 + BDX
	1.1 (-/-/S 371)	35		01.84 10.86	24.5229-0240.3	330400	2	L=242
	1.1 (B/C/- 371)	35		01.83 06.87				
	1.2 (B/C/S 37S)	40		01.86 11.89				
	1.4 (-/-/S 373)			01.85 10.86				
	1.4 (B/C/- 372)	44		01.83 12.86				
	1.4 (B/C/- 373)			01.83 11.89				
	1.4 (B/C/- 37C)	44		10.86 11.89				
	1.4 (B/C/- 37R)	49		06.87 11.89				
	1.4 i (B/C/- 37A)			06.87 11.89				
	1.4 T (B/C/- 375)	40		01.84 11.89				
	1.6 D (B/C/S 374)	40		01.84 11.89				
	1.7 (B/C/- 376)	59		01.84 06.87				
	1.7 (B/C/- 37D)	64		06.87 11.89				

























RENAULT R11 (83-89)										
		kw								
	1.7 (B/C/- 37N) 1.7 i (B/C/- 37E)	65 69		10.86 10.86	11.89 11.89	24.5229-0240.3	330400	2	L=242	
	1.1 (B/C/S 371)	35		10.86	06.87	24.3222-1709.3 24.3222-1710.3	020111 020112	 	Rz 22,20 Rz 22,20	BDX BDX
	1.2 (B/C/S 37S) 1.4 (B/C/- 372) 1.4 (B/C/S 373) 1.4 T (B/C/- 375) 1.6 D (B/C/S 374) 1.7 (B/C/- 376) 1.7 i (B/C/- 37F)	40 44 44 44 40 59 55		01.86 01.83 01.83 01.84 01.84 01.84 01.85	09.86 12.86 09.86 09.86 09.86 08.86 09.86	24.3222-1709.3 24.3222-1710.3 24.3222-1106.3 24.3222-1107.3	020111 020112 020261 020262	   	Rz 22,20 Rz 22,20 Rz 22,20 Rz 22,20	BDX BDX LUC LUC
	1.2 (B/C/S 37S) 1.4 (B/C/- 37C) 1.4 (B/C/- 37R) 1.4 (B/C/S 373) 1.4 i (B/C/- 37A) 1.4 T (B/C/- 375) 1.6 D (B/C/S 374) 1.7 (B/C/- 376) 1.7 (B/C/- 37D) 1.7 (B/C/- 37L) 1.7 (B/C/- 37N) 1.7 i (B/C/- 37E) 1.7 i (B/C/- 37F)	40 44 49 40 40 59 64 54 65 69 55		10.86 10.86 06.87 10.86 06.87 10.86 10.86 09.86 06.87 10.86 10.86 10.86 01.85	11.89 11.89 11.89 11.89 11.89 11.89 11.89 06.87 11.89 11.89 11.89 11.89 11.89	24.3220-1603.3 24.3220-1604.3 24.3222-1106.3 24.3222-1107.3	020230 020231 020261 020262	   	RzR 20,64 RzR 20,64 Rz 22,20 Rz 22,20	BDX BDX LUC LUC
	1.1 (B/C/S 371) 1.2 (B/C/S 37S) 1.4 (B/C/- 37C) 1.4 (B/C/- 37R) 1.4 (B/C/S 373) 1.4 i (B/C/- 37A) 1.6 D (B/C/S 374) 1.7 (B/C/- 376) 1.7 (B/C/- 37D) 1.7 (B/C/- 37L) 1.7 (B/C/- 37N) 1.7 i (B/C/- 37E) 1.7 i (B/C/- 37F)	35 40 44 49 40 59 64 54 65 69 55		01.83 01.86 10.86 06.87 10.86 06.87 10.86 09.86 06.87 10.86 10.86 10.86 01.85	06.87 11.89 11.89 11.89 11.89 11.89 06.87 06.87 11.89 11.89 11.89 11.89 11.89	03.0137-0209.2 03.0137-0203.2 03.0137-0201.2 03.0137-9086.2 03.0137-9055.2 03.0137-9056.2	650209 650203 650201 669086 669055 669056	- autom. Nachstellung ¹⁾ + autom. Nachstellung ²⁾	180 x 42 180 x 42 AUT 180 x 41 HEB Bremsbacken-Zubehör Bremsbacken-Zubehör Bremsbacken-Zubehör	BDX BDX LUC BDX BDX LUC
	1.1 (B/C/S 371) 1.2 (B/C/S 37S) 1.4 (B/C/- 37C) 1.4 (B/C/- 37R) 1.4 (B/C/S 373) 1.4 i (B/C/- 37A) 1.6 D (B/C/S 374) 1.7 (B/C/- 376) 1.7 (B/C/- 37D) 1.7 (B/C/- 37L) 1.7 (B/C/- 37N) 1.7 i (B/C/- 37E) 1.7 i (B/C/- 37F)	35 40 44 49 40 59 64 54 65 69 55		01.83 10.86 10.86 06.87 10.86 06.87 10.86 09.86 06.87 10.86 10.86 10.86 01.85	06.87 11.89 11.89 11.89 11.89 11.89 11.89 06.87 11.89 11.89 11.89 11.89 11.89	24.0218-0032.1 24.0218-0732.2	480118 480207		180/181 x 53,5 - Lager 180/181 x 53,2 + Lager	
	1.1 (B/C/S 371) 1.1 (B/C/S 371) 1.2 (B/C/S 37S) 1.4 (B/C/- 372) 1.4 (B/C/S 373) 1.4 T (B/C/- 375) 1.6 D (B/C/S 374) 1.7 (B/C/- 376) 1.7 i (B/C/- 37F)	35 35 40 44 40 59 64 55		01.83 10.86 01.86 01.83 01.84 01.84 01.84 01.84 01.85	09.86 06.87 09.86 12.86 09.86 09.86 09.86 09.86 09.86	03.0520-1117.3 03.0520-0922.3 03.0520-0922.3 03.0520-1122.3	691117 690922 690922 691122	+ autom. Nachstellung ²⁾ + autom. Nachstellung ²⁾	17,46/180x42 TopKit 22,20/180x42 TopKit 22,20/180x42 TopKit 22,20/180x41 TopKit	BDX BDX BDX LUC
	1.2 (B/C/S 37S) 1.4 (B/C/- 37C) 1.4 (B/C/- 37R) 1.4 (B/C/S 373) 1.4 i (B/C/- 37A) 1.6 D (B/C/S 374) 1.7 (B/C/- 376) 1.7 (B/C/- 37D) 1.7 (B/C/- 37L) 1.7 (B/C/- 37N) 1.7 i (B/C/- 37E) 1.7 i (B/C/- 37F)	40 44 49 40 59 64 54 65 69 55		10.86 10.86 06.87 10.86 06.87 10.86 10.86 06.87 10.86 10.86 10.86 10.86	11.89 11.89 11.89 11.89 11.89 11.89 11.89 11.89 11.89 11.89 11.89 11.89	03.0520-0920.3 03.0520-1122.3	690920 691122		20,64/180x42 TopKit 22,20/180x41 TopKit	BDX LUC
RENAULT R12 (70-80)										
	1.3 (R1170) 1.3 (R1170) 1.3 (R1170) 1.3 (R1170) 1.3 (R1170) 1.3 (R1170) 1.3 (R1177) 1.3 (R1177) 1.3 (R1177) 1.3 (R1177) 1.3 (R1177) 1.3 (R1177) 1.3 (R1177)	1396401 1281821 1281821 1460412 1624301 0266701 0266701 0266701 0331341 0331643 0382301	1403219 1396327 0312522	+ F + E 12.80 - D 12.80 + A B CH DK N 12.80 + D GB TR 12.80 + P + F 12.79 + F B A CH 12.79 + DK N 12.79 + D GB TR 12.79 + F 12.79 + P MA	03.2119-0781.3	010052			Thz 19,05	ATE

¹⁾ - automatic adjustment / - correzione automatica / - ajustage automatique / - reajuste automatico

²⁾ + automatic adjustment / + correzione automatica / + ajustage automatique / + reajuste automático

RENAULT R12 (70-80)									
	1.3 (R1330) 1.3 (R1330) 1.3 (R1330) 1.3 (R1330) 1.3 (R1337) 1.3 (R1337) 1.3 (R1337) 1.3 (R1337) 1.3 (R1337) 1.3 (R2360) 1.3 (R2360) 1.3 (R2360) 1.3 (R2360) 1.3 (R2360) 1.4 (R1179) 1.4 (R1338)	0262013 0262013 0317821 0375981 0028396 0031001 0035168 0028396 0035155 0003887 0006151 0006114 0003887 0009201 0002937 0001975	0301630 0033533 0004984	12.80 12.80 12.80 12.80 12.80 12.80 12.80 12.80 12.80 12.80 12.80 12.80 12.80 12.80 12.80 12.80	+ F + B A DK N IL + F + F / + Automatikgetriebe ¹⁾ + F B / + Schaltgetriebe ²⁾ + F / + Automatikgetriebe ¹⁾ + B CH DK IL / + Automatik. ³⁾ + F + F + B + E DK MA IL + RA BR C + S + S	03.2119-0781.3 010052		THz 19,05	ATE
	1.3 (R1170) 1.3 (R1170) 1.3 (R1330) 1.4 (R1179) 1.4 (R1338)	1460412 0317359 0009901	1624841 0376767 0017282	01.70 01.76	+ MEX + MEX + CHN + CHN	13.0460-3928.2 603928		20140 14,0 +/WE	BDX
	1.3 (R1170) 1.3 (R1330) 1.3 (R1337) 1.3 (R2360) 1.4 (R1179) 1.4 (R1338)			01.70 01.72 01.74 01.76 01.76 01.76	12.80 12.80 12.80 12.80 12.80 12.80	24.0110-0139.1 410139		228 10,0 9,0	
	1.6 (R1173)			01.71	12.74	24.0110-0139.1 410139		228 10,0 9,0	
	1.3 (R1330) Kombi 1.3 (R1337) Kombi 1.3 (R2360) 1.4 (R1179) 1.4 (R1338) Kombi	0007115		01.76 01.76 01.76 01.76	12.80 12.80 12.80 12.80 + CHN 12.80	24.3222-1125.3 020356		Rz 22,20	
	1.3 (R1330) 1.3 (R1337) 1.3 (R2360) 1.4 (R1338)			01.76 01.76 01.76 01.76	12.80 12.80 12.80 12.80	03.0137-0124.2 650124 03.0137-0139.2 650139 03.0137-9020.2 669020		229 x 42 HEB AUT 229 x 42 Bremsbacken-Zubehör	BDX BDX BDX
RENAULT R14 (76-83)									
	1.2 (R1210) 1.2 TL/GTL (R1210) 1.4 (R1212) 1.4 (R1212) 1.4 (R1213)		0570870 0083700	01.76 01.80 01.82	+ CH - CH + CH - CH - CH	03.2119-0781.3 010052		THz 19,05	ATE
	1.2 (R1210) 1.4 (R1212) 1.4 (R1213)			01.76 01.80 01.82	12.83 12.83 12.83	13.0460-3928.2 603928		20140 14,0 +/WE	BDX
	1.2 (R1210) 1.4 (R1212) 1.4 (R1213)			01.76 01.80 01.82	12.83 12.83 12.83	24.3222-1709.3 020111 24.3222-1710.3 020112 24.3222-1106.3 020261 24.3222-1107.3 020262	 	Rz 22,20 Rz 22,20 Rz 22,20 Rz 22,20	BDX BDX LUC LUC
RENAULT R15 (72-79)									
	1.3 (R1300)	0126200		12.79		03.2119-0781.3 010052		THz 19,05	ATE
	1.3 (R1300) 1.6 (R1304) 1.6 (R1308)			01.72 01.72 01.72	12.79 12.76 + CHN 12.76 + USA	13.0460-3928.2 603928		20140 14,0 +/WE	BDX
	1.3 (R1300) 1.6 (R1304) 1.6 (R1308)			01.72 01.72 01.72	12.79 12.76 + CHN 12.76 + USA	24.0110-0139.1 410139		228 10,0 9,0	
RENAULT R16 (68-80)									
	1.6 (R1152) 1.6 (R1153) 1.6 (R1155) 1.6 (R1157)			01.68 01.69 01.75 01.77	12.80 + F 12.79 + F 12.79 + F 12.79 + F	24.3222-1125.3 020356		Rz 22,20	
	1.6 (R1152) 1.6 (R1153) 1.6 (R1155) 1.6 (R1156) 1.6 (R1157)			01.72 01.72 01.75 01.74 01.77	12.80 12.80 12.79 12.80 12.79	03.0137-0271.2 650271 03.0137-9027.2 669027		229 x 42 HEB Bremsbacken-Zubehör	LUC LUC
RENAULT R17 (72-80)									
	1.6 (R1312) 1.6 (R1314) 1.6 (R1316) 1.6 (R1317) 1.6 (R1318) 1.6 (R1322) 1.6 (R1323) 1.6 (R1324) 1.6 (R1326)	0008153	0030470	01.72 01.72 01.72 01.76 01.72 01.72 01.72 01.72 01.72	12.75 12.75 12.78 12.80 12.76 12.77 12.75 12.75 12.80	13.0460-3928.2 603928		20140 14,0 +/WE	BDX

1) + F / + autom.transmission / + B / + scatola cambio autom. / + F / + transmission automatique / + F / + cambio automático
 2) + F B / + manual transm. / + F B / + scatola camb.velocità / + F B / + transmission mécanique / + F B / + cambio de velocidad
 3) + B CH DK IL / + autom.transm. / + B CH DK IL / +scat.camb.autom. / + B CH DK IL / + transm.autom. / + B CH DK IL / + camb.autom.

								
RENAULT R17 (72-80)								
	1.6 (R1327) 1.6 (R1328)			01.76 01.76	12.78 12.78		13.0460-3928.2 603928	20140 14,0 +/-WE BDX
	1.6 (R1313) 1.6 (R1316) 1.6 (R1323) 1.6 (R1326)	0007371 0001511		01.72 01.72 01.72 01.72	12.76 + CHN 12.75 12.77 + CHN 12.80		24.0110-0139.1 410139	228 10,0 9,0
	1.6 (R1313) 1.6 (R1317) 1.6 (R1327) 1.6 TS (R1323)			01.72 01.72 01.72 01.72	12.76 - CHN USA 12.80 12.80 12.77		13.0460-3961.2 603961	20336 14,0 +/-WK BDX
	1.6 (R1313) 1.6 (R1317) 1.6 (R1327) 1.6 TS (R1323)			01.72 01.72 01.72 01.72	12.76 - CHN USA 12.80 12.80 12.77		24.0110-0139.1 410139	228 10,0 9,0
	1.6 (R1312) 1.6 (R1313) 1.6 (R1316) 1.6 (R1318) 1.6 (R1322) 1.6 (R1326) 1.6 (R1328) 1.6 (R1328) 1.6 TL (R1323)			01.72 01.72 01.72 01.76 01.72 01.72 01.76 01.79 01.72	12.76 12.76 12.75 12.80 12.76 12.80 12.78 - CHN USA 12.80 12.80		24.3222-1125.3 020356	Rz 22,20
RENAULT R18 Kasten (79-86)								
	1.4 (R2350) 2.1 D (R2354)	47 49		01.82 01.82	07.86 07.86		03.2119-0781.3 010052 03.2119-1281.3 010054	THz 19,05 ATE THz 19,05 ATE
	1.4 (R2350) 2.1 D (R2354)	47 49		01.83 01.83	07.86 07.86		13.0460-3911.2 603911 13.0460-2834.2 602834 13.0460-0411.2 610411 13.0460-3911.2 603911 13.0460-0411.2 610411	20905 18,0 +/-WK BDX 21463 18,0 /WK/S LUC Belagsatz-Zubehör BDX 20905 18,0 +/-WK BDX Belagsatz-Zubehör BDX
	1.4 (R2350)	47		01.82	12.83		24.0110-0139.1 410139	228 10,0 9,0
	2.1 D (R2354)	49		11.81	07.86		24.5112-0385.3 330392	2 L=385
	1.4 (R2350) 2.1 D (R2354)	47 49		05.79 11.81	07.86 07.86		24.5112-0220.3 330613	2 L=220
	1.4 (R2350) 2.1 D (R2354)	47 49		01.82 11.81	07.86 07.86		24.3222-1118.3 020315	Rz 22,20 BDX
	1.4 (R2350) 2.1 D (R2354)	47 49		01.82 11.81	07.86 07.86		03.0137-0124.2 650124 03.0137-9020.2 669020	229 x 42 HEB AUT BDX Bremsbacken-Zubehör BDX
	1.4 (R2350) 2.1 D (R2354)	47 49		01.82 11.81	07.86 07.86		03.0520-3122.3 693122	22,20/229x42 TopKit BDX
RENAULT R18 Limousine (78-86)								
	1.4 (R1340) 1.4 (R1340) 1.6 (R1341) 1.6 (R1341) 1.6 (R1341) 1.6 (R1341) 2.1 D (R1344) 2.1 D (R1344) 2.1 D (R1346)	47 47 54 54 58 58 49 49 53	0346651 0262801 0262801	04.78 04.78 04.82 04.82 04.78 04.78 05.82 11.81 11.81	+ CHN - CHN + CHN - CHN + CHN - CHN + E - E 07.86 07.86		03.2119-0781.3 010052 03.2119-1281.3 010054	THz 19,05 ATE THz 19,05 ATE
	1.6 TS (R1342) 1.6 Turbo (R1345) 1.6 Turbo (R1345) 2.0 (R1343) 1.4 (R1340) 1.6 (R1341) 1.6 TS (R1342) 1.6 Turbo (R1345) 2.0 (R1343) 2.1 D (R1344) 2.1 D (R1346)	71 80 92 77 47 54 71 92 77 49 53		05.82 10.80 10.82 05.82 01.83 01.83 01.83 01.83 01.83 01.83 11.81	12.82 09.82 12.82 12.82 07.86 07.86 07.86 07.86 07.86 07.86 07.86		24.3541-1625.5 240045 24.3541-1626.5 240046 24.3541-1625.5 240045 24.3541-1626.5 240046	D=54, - Halter LUC D=54, - Halter LUC D=54, - Halter LUC D=54, - Halter LUC
	1.4 (R1340) 1.6 (R1341) 2.0 (R1343) 2.1 D (R1344) 2.1 D (R1346) 1.6 TS (R1342) 1.6 Turbo (R1345)	47 54 77 49 53 71 92		01.83 01.83 01.83 01.83 11.81 01.83 01.83	07.86 07.86 07.86 07.86 07.86 07.86 07.86		13.0460-3911.2 603911 13.0460-2834.2 602834 13.0460-0411.2 610411 13.0460-2834.2 602834	20905 18,0 +/-WK BDX 21463 18,0 /WK/S LUC Belagsatz-Zubehör BDX 21463 18,0 /WK/S LUC

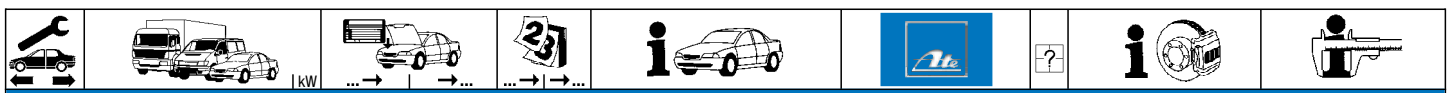









RENAULT R18 Limousine (78-86)

	1.4 (R1340)	47	0534400	04.78	+ (CN) (USA)	24.0110-0139.1	410139		228 10,0 9,0																
	1.6 (R1341)	54	0504400	04.82	+ (CN) (USA)																				
	1.6 (R1341)	58	0504400	04.78	+ (CN) (USA)																				
	1.6 TS (R1342)	71	0026201	07.86		24.0120-0148.1	420148		238 20,0 17,7 V																
	2.0 (R1343)	77	0008901	07.86																					
	2.1 D (R1346)	53		11.81	07.86																				
	1.4 (R1340)	47	0534401	07.86	+ (CN) (USA)																				
	1.6 (R1341)	54	0504401	07.86	+ (CN) (USA)	24.0120-0126.1	420126		259 20,2 17,7 V +B																
	1.6 (R1341)	58	0504401	09.82	+ (CN) (USA)																				
	1.6 (R1341)	58	0504401	09.82	+ (CN) (USA)																				
	1.6 TS (R1342)	71		05.82	07.86	24.5112-0385.3	330392	2	L=385																
	1.6 Turbo (R1345)	80		10.80	09.82																				
	1.6 Turbo (R1345)	92		10.82	07.86																				
	2.0 (R1343)	77		05.82	07.86																				
	2.1 D (R1344)	49		11.81	07.86																				
	2.1 D (R1346)	53		11.83	07.86																				
	1.6 Turbo (R1345)	80		10.80	09.82	13.0460-3961.2	603961		20336 14,0 +/-WK BDX																
	1.6 Turbo (R1345)	92		10.82	07.86																				
	1.6 Turbo (R1345)	80		10.80	09.82	24.0112-0134.1	412134		254 12,0 10,5																
	1.6 Turbo (R1345)	92		10.82	07.86																				
	1.4 (R1340)	47		04.78	07.86	24.5112-0220.3	330613	2	L=220																
	1.6 (R1341)	54		04.82	07.86																				
	1.6 (R1341)	58		04.78	09.82																				
	1.6 TS (R1342)	71		05.82	07.86																				
	1.6 Turbo (R1345)	80		10.80	09.82																				
	1.6 Turbo (R1345)	92		10.82	07.86																				
	2.0 (R1343)	77		05.82	07.86																				
	2.1 D (R1344)	49		11.81	07.86																				
	2.1 D (R1346)	53		11.81	07.86																				
		1.4 (R1340)	47	0534400	04.78						24.3222-1710.3	020112		Rz 22,20 BDX											
1.6 (R1341)		54	0504400	04.82		24.3222-1709.3	020111		Rz 22,20 BDX																
1.6 (R1341)		58	0504400	04.78						24.3222-1106.3					020261		Rz 22,20 LUC								
1.6 TS (R1342)		71	0024200	05.82														24.3222-1107.3	020262		Rz 22,20 LUC				
2.1 D (R1344)		49		11.81	07.86																	24.3222-1118.3	020315		Rz 22,20 BDX
1.4 (R1340)		47	0534401	07.86																					
1.6 (R1341)	54	0504401	07.86		24.3222-1106.3						020261		Rz 22,20 LUC												
1.6 (R1341)	58	0504401	09.82			24.3222-1107.3	020262		Rz 22,20 LUC																
1.6 TS (R1342)	71	0024201	07.86							24.3222-1118.3				020315		Rz 22,20 BDX									
1.6 Turbo (R1345)	80		10.80	09.82													24.3222-1118.3	020315		Rz 22,20 BDX					
1.6 Turbo (R1345)	92		10.82	07.86																	24.3222-1118.3	020315		Rz 22,20 BDX	
2.0 (R1343)	77		05.82	07.86																					24.3222-1118.3
2.1 D (R1346)	53		11.81	07.86	24.3222-1118.3						020315		Rz 22,20 BDX												
	1.6 Turbo (R1345)	80		10.80		09.82	03.0137-0124.2	650124																	
	1.6 Turbo (R1345)	92		10.82		07.86				03.0137-9020.2				669020		Bremsbacken-Zubehör BDX									
	2.0 (R1343)	77		05.82		07.86											03.0137-9020.2	669020		Bremsbacken-Zubehör BDX					
	2.1 D (R1346)	53		11.81		07.86															03.0137-9020.2	669020		Bremsbacken-Zubehör BDX	
	1.6 Turbo (R1345)	80		10.80		09.82	03.0520-3122.3	693122																	22,20/229x42 TopKit BDX
	1.6 Turbo (R1345)	92		10.82	07.86	03.0520-3122.3				693122		22,20/229x42 TopKit BDX													
	2.0 (R1343)	77		05.82	07.86								03.0520-3122.3	693122		22,20/229x42 TopKit BDX									
	2.1 D (R1346)	53		11.81	07.86												03.0520-3122.3	693122		22,20/229x42 TopKit BDX					

RENAULT R18 Variable (79-86)

	1.4 (R1350)	47	0048380	05.79	+ (CH)	03.2119-0781.3	010052		Thz 19,05 ATE																
	1.4 (R1350)	47		05.79	07.86 - (CH)																				
	1.6 (R1351)	54		01.82	07.86 - (CH) (CN) (USA)																				
	1.6 (R1351)	58		05.79	09.82 - (CH) (CN) (USA)																				
	2.1 D (R1354)	49		11.80	07.86 + (E)																				
	1.6 (R1351)	54		01.82	12.83 + (CN) (USA)	03.2119-1281.3	010054		Thz 19,05 ATE																
	1.6 (R1351)	58		05.79	09.82 + (CN) (USA)																				
	1.6 4x4 (R1351)	54		01.83	07.86																				
	2.1 D (R1354)	49		11.80	07.86 - (E)																				
	1.6 TS (R1352)	71		05.82	12.82																				
	2.0 (R1353)	77		10.81	12.82	24.3541-1625.5	240045		D=54, - Halter LUC																
	1.6 TS (R1352)	71		01.83	07.86					24.3541-1626.5	240046		D=54, - Halter LUC												
	1.6 Turbo (R1355)	80		01.83	07.86									24.3541-1626.5	240046		D=54, - Halter LUC								
	1.6 Turbo (R1355)	92		10.82	07.86													24.3541-1626.5	240046		D=54, - Halter LUC				
	2.0 (R1353)	77		01.83	07.86																	24.3541-1626.5	240046		D=54, - Halter LUC
	2.0 4x4 (R1353)	76		05.83	12.86																				
	1.4 (R1350)	47		01.83	07.86	13.0460-3911.2	603911		20905 18,0 +/-WK BDX																
	1.6 (R1351)	54		01.83	07.86					13.0460-2834.2	602834		21463 18,0 /WK/S LUC												
	1.6 4x4 (R1351)	54		01.83	07.86									13.0460-0411.2	610411		Belagsatz-Zubehör BDX								
	2.0 (R1353)	77		01.83	07.86													13.0460-0411.2	610411		Belagsatz-Zubehör BDX				
	2.0 4x4 (R1353)	76		05.83	12.86																	13.0460-0411.2	610411		Belagsatz-Zubehör BDX
1.6 TS (R1352)	71		01.83	07.86	13.0460-2834.2	602834		21463 18,0 /WK/S LUC																	
1.6 Turbo (R1355)	92		01.83	07.86					13.0460-2834.2	602834		21463 18,0 /WK/S LUC													
2.1 D (R1354)	49		01.83	07.86									13.0460-3911.2	603911		20905 18,0 +/-WK BDX									
2.1 D (R1356)	53		01.83	07.86													13.0460-3911.2	603911		20905 18,0 +/-WK BDX					
	1.4 (R1350)	47		05.79																	12.82	24.0110-0139.1	410139		228 10,0 9,0
	1.6 (R1351)	54		01.82	12.82 - (E)																				
	1.6 (R1351)	58		05.79	09.82 - (E)																				
	1.6 (R1351)	58		05.79	12.80 + (E)																				
	2.0 (R1353)	77	0009101	07.86		24.0120-0148.1	420148		238 20,0 17,7 V																
	2.1 D (R1356)	53		01.83	07.86																				

RENAULT R18 Variable (79-86)										
	1.6 Turbo (R1355)	80		09.82	07.86	24.0120-0126.1	420126			259 20,2 17,7 V +B
	1.6 Turbo (R1355)	92		10.82	07.86					
	1.6 (R1351)	54		01.82	07.86	24.5112-0385.3	330392	2		L=385
	1.6 (R1351)	58		05.79	09.82					
	1.6 4x4 (R1351)	54		01.83	07.86					
	1.6 TS (R1352)	71		05.82	07.86					
	1.6 Turbo (R1355)	80		09.82	07.86					
	1.6 Turbo (R1355)	92		10.82	07.86					
	2.0 (R1353)	77		10.81	07.86					
	2.0 4x4 (R1353)	76		05.83	12.86					
	2.1 D (R1354)	49		01.81	07.86					
	2.1 D (R1356)	53		05.79	07.86					
	1.6 Turbo (R1355)	80		09.82	07.86	13.0460-3961.2	603961			20336 14,0 +/-WK BDX
	1.6 Turbo (R1355)	92		10.82	07.86					
	1.6 Turbo (R1355)	80		09.82	07.86	24.0112-0134.1	412134			254 12,0 10,5
	1.6 Turbo (R1355)	92		10.82	07.86					
	1.4 (R1350)	47		05.79	07.86	24.5112-0220.3	330613	2		L=220
	1.6 (R1351)	54		01.82	07.86					
	1.6 (R1351)	58		05.79	09.82					
	1.6 4x4 (R1351)	54		01.83	07.86					
	1.6 TS (R1352)	71		05.82	07.86					
	1.6 Turbo (R1355)	80		09.82	07.86					
	1.6 Turbo (R1355)	92		10.82	07.86					
	2.0 (R1353)	77		10.81	07.86					
	2.0 4x4 (R1353)	76		05.83	12.86					
	2.1 D (R1354)	49		11.80	07.86					
	2.1 D (R1356)	53		05.79	07.86					
	1.4 (R1350)	47		05.79	07.86	24.3222-1118.3	020315			Rz 22,20 BDX
	1.6 (R1351)	54		01.82	07.86					
	1.6 (R1351)	58		05.79	09.82					
	1.6 4x4 (R1351)	54		01.83	07.86					
	1.6 TS (R1352)	71		05.82	07.86					
	1.6 Turbo (R1355)	80		09.82	12.82					
	1.6 Turbo (R1355)	92		10.82	12.82					
	2.0 (R1353)	77		10.81	07.86					
	2.0 4x4 (R1353)	76		05.83	12.86					
	2.1 D (R1354)	49		11.80	07.86					
	2.1 D (R1356)	53		05.79	07.86					
	1.4 (R1350)	47		05.79	12.82	03.0137-0124.2	650124			229 x 42 HEB AUT BDX
	1.6 (R1351)	54		01.82	07.86	03.0137-9020.2	669020			Bremsbacken-Zubehör BDX
	1.6 (R1351)	58		05.79	09.82					
	1.6 4x4 (R1351)	54		01.83	07.86					
	1.6 TS (R1352)	71		05.82	07.86					
	1.6 Turbo (R1355)	80		09.82	12.82					
	1.6 Turbo (R1355)	92		10.82	12.82					
	2.0 (R1353)	77		10.81	07.86					
	2.0 4x4 (R1353)	76		05.83	12.86					
	2.1 D (R1354)	49		11.80	07.86					
	2.1 D (R1356)	53		05.79	07.86					
	1.4 (R1350)	47		05.79	07.86	03.0520-3122.3	693122			22,20/229x42 TopKit BDX
	1.6 (R1351)	54		01.82	07.86					
	1.6 (R1351)	58		05.79	09.82					
	1.6 4x4 (R1351)	54		01.83	07.86					
	1.6 TS (R1352)	71		05.82	07.86					
	1.6 Turbo (R1355)	80		09.82	12.82					
	1.6 Turbo (R1355)	92		10.82	12.82					
	2.0 (R1353)	77		10.81	07.86					
	2.0 4x4 (R1353)	76		05.83	12.86					
	2.1 D (R1354)	49		11.80	07.86					
	2.1 D (R1356)	53		05.79	07.86					
RENAULT R19 (3/5-tuerig) (B53/C53/S53_) (88-95)										
	1.2	40		09.88	01.92	03.2119-3389.3	010057			Thz 19,05 ATE
	1.4	43		09.88	01.92					
	1.4 (B/C/S537)	59		09.88	01.92					
	1.4 (B/C53A)	59		09.90	01.92					
	1.4 (B537)	59		02.92	12.95					+ Fahrschule 1)
	1.4 (B53A)	59		02.92	12.95					- ABS/ + Fahrschule 2)
	1.4 (B53H)	59		06.89	12.95					
	1.7	66		09.88	01.92					- ABS
	1.7	66		02.92	12.95					- ABS/ + Fahrschule 2)
	1.7 (B/C533)	54		09.88	01.92					- ABS
	1.7 (B533)	54		02.92	12.95					- ABS/ + Fahrschule 2)
	1.7 (B536/E)	54		09.88	12.95					
	1.7 (B53M)	54		09.88	12.95					- ABS
	1.9 D (B/C534/J)	47		09.88	01.92					- ABS
	1.9 D (S534/J)	47		09.88	01.92					
	1.9 dT (B/C53K)	66		09.90	01.92					- ABS
	1.9 dT (B53K)	66		02.92	12.95					- ABS/ + Fahrschule 2)
	1.9 dT (S53K)	66		04.91	01.92					
	1.2	40		02.92	12.95	03.2120-2031.3	010106			Thz 20,64 ATE
	1.4	43		02.92	12.95					
	1.4 (B/C535)	55		09.94	12.95					- ABS

1) + driving school / + scuola guida / + auto école / + autoescuela

2) - ABS/ + driving school / - ABS/ + scuola guida / - ABS/ + auto école / - ABS/ + autoescuela

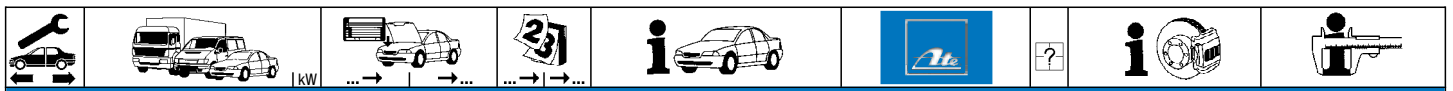

RENAULT R19 (3/5-tuerig) (B53/C53/S53_) (88-95)

	1.4 (B537)	59	02.92	12.95	- Fahrschule ¹⁾	03.2120-2031.3	010106			Thz 20,64	ATE
	1.4 (B53A)	59	02.92	12.95	- ABS/ - Fahrschule ²⁾						
	1.4 (B53G)	59	05.92	12.95							
	1.4 (C/S537)	59	02.92	12.95							
	1.4 (C53A)	59	02.92	12.95	- ABS						
	1.7 (B533)	54	02.92	12.95	- ABS/ - Fahrschule ²⁾						
	1.7 (B53B)	54	02.92	12.95	- ABS/ - Fahrschule ²⁾						
	1.7 (B53C/F)		02.92	12.95	- ABS/ - Fahrschule ²⁾						
	1.7 (C533)	54	02.92	12.95	- ABS						
	1.7 (C53B)	54	02.92	12.95	- ABS						
	1.7 (C53C/F)		02.92	12.95	- ABS						
	1.8	65	05.92	12.95	- ABS						
	1.8 (B/C53V/553H)		09.94	12.95							
	1.8 (B553A/C/D/F)	66	09.94	12.95	- ABS						
	1.8 (C353A/C/D/F)	66	09.94	12.95	- ABS						
	1.8 16V	99	09.88	12.95	- ABS						
	1.9 D (B/C53I)	47	05.92	12.95	- ABS						
	1.9 D (B534/J)	47	02.92	12.95	- ABS/ - Fahrschule ²⁾						
	1.9 D (C534/J)	47	02.92	12.95	- ABS						
	1.9 D (C534/J)	47	02.92	12.95							
	1.9 D (S53I)	47	05.92	12.95							
	1.9 dT (B/C53T)	66	05.92	12.95							
	1.9 dT (B53K)	66	02.92	12.95	- ABS/ - Fahrschule ²⁾						
	1.9 dT (C53K)	66	02.92	12.95	- ABS						
	1.9 dT (S53K)	66	02.92	12.95							
	1.4	55	09.94	12.95	+ ABS/ + Schaltgetriebe ³⁾	24.2120-1725.3	010579			Thz 20,64	BDX
	1.7	54	09.88	12.95	+ ABS/ + Schaltgetriebe ³⁾						
	1.7	66	09.88	12.95	+ ABS/ + Schaltgetriebe ³⁾						
	1.8	65	05.92	12.95	+ ABS/ + Schaltgetriebe ³⁾						
	1.8	66	09.94	12.95	+ ABS/ + Schaltgetriebe ³⁾						
	1.8	81	10.91	12.95	+ ABS/ + Schaltgetriebe ³⁾						
	1.8 16V (B/C539)	99	09.88	12.95	+ ABS/ + Schaltgetriebe ³⁾						
	1.8 16V (B/C53D)	99	06.89	12.95	+ ABS/ + Schaltgetriebe ³⁾						
	1.9 D (B/C534/J)	47	09.88	12.95	+ ABS/ + Schaltgetriebe ³⁾						
	1.9 dT	66	10.95	12.95	+ ABS/ + Schaltgetriebe ³⁾						
	1.9 dT (B/C53T)	66	10.95	12.95	+ ABS/ + Schaltgetriebe ³⁾						
	1.2	40	09.88	12.95		24.3481-1505.5	240047			D=48, - Halter	BDX
	1.4	43	09.88	12.95		24.3481-1506.5	240048			D=48, - Halter	BDX
	1.4 (B/C535)	55	09.94	12.95		24.3481-1611.5	240029			D=48, - Halter	LUC
	1.7 (B/C536/E)		09.88	12.95		24.3481-1612.5	240030			D=48, - Halter	LUC
	1.9 D (B/C/S53I)	47	05.92	12.95		24.0101-4803.2	260049			Bremssattel-Zubehör	BDX
	1.9 D (B/C534/J)	47	09.88	12.95	- ABS	24.0101-4807.2	260053			Bremssattel-Zubehör	LUC
	1.9 D (B/C534/J)	47	10.91	12.95	+ ABS						
	1.9 D (S534/J)	47	09.88	12.95							
	1.4 (B/C53A)	59	09.90	12.95		24.3481-1505.5	240047			D=48, - Halter	BDX
	1.7 (B/C53B)	54	09.88	12.95		24.3481-1506.5	240048			D=48, - Halter	BDX
						24.0101-4803.2	260049			Bremssattel-Zubehör	BDX
	1.4 (B/C53A)	59	09.90	12.95	- ABS	24.3481-1611.5	240029			D=48, - Halter	LUC
	1.4 (B/C53A)	59	09.90	12.94	+ ABS	24.3481-1612.5	240030			D=48, - Halter	LUC
	1.4 (B/C53A)	59	09.90	12.95		24.0101-4807.2	260053			Bremssattel-Zubehör	LUC
	1.7 (B/C53B)	54	09.88	12.95	- ABS						
	1.7 (B/C53B)	54	09.88	12.94	+ ABS/ + Automatikgetriebe ⁴⁾						
	1.7 (B/C53B)	54	09.88	12.95	+ Schaltgetriebe ⁵⁾						
	1.7 (B/C53M)	54	09.88	12.95							
	1.4 (B/C53A)	59	01.95	12.95	+ ABS/ + Automatikgetriebe ⁴⁾	24.3481-1615.5	240031			D=48, - Halter	LUC
	1.7 (B/C533)	54	09.88	12.95		24.3481-1616.5	240032			D=48, - Halter	LUC
	1.7 (B/C53B)	54	01.95	12.95	+ ABS/ + Automatikgetriebe ⁴⁾	24.0101-4806.2	260052			Bremssattel-Zubehör	LUC
	1.7 (B/C53C/F)		09.88	12.95							
	1.8	65	05.92	12.95							
	1.8	66	09.94	12.95							
	1.8	81	10.91	12.95							
	1.8 16V	99	09.88	12.95							
	1.9 D (B/C534/J)	47	09.88	09.91	+ ABS						
	1.9 dT	66	09.90	12.95							
	1.9 dT (B/C53T)	66	05.92	12.95							
	1.2	40	09.88	12.95		13.0460-3911.2	603911			20905 18,0 +/WK	BDX
	1.4	43	09.88	12.95		13.0460-2834.2	602834			21463 18,0 /WK/S	LUC
	1.4 (B/C535)	55	09.94	12.95		13.0460-0411.2	610411			Belagsatz-Zubehör	BDX
	1.7 (B/C536/E)		09.88	12.95							
	1.9 D (B/C/S53I)	47	05.92	12.95							
	1.9 D (B/C534/J)	47	09.88	12.95	- ABS						
	1.9 D (B/C534/J)	47	10.91	12.95	+ ABS						
	1.9 D (S534/J)	47	09.88	12.95							
	1.4 (B/C53A)	59	09.90	12.95		13.0460-3911.2	603911			20905 18,0 +/WK	BDX
	1.7 (B/C53B)	54	09.88	12.95		13.0460-0411.2	610411			Belagsatz-Zubehör	BDX
	1.4 (B/C53A)	59	09.90	12.95	- ABS	13.0460-2834.2	602834			21463 18,0 /WK/S	LUC
	1.4 (B/C53A)	59	09.90	12.94	+ ABS/ + Automatikgetriebe ⁴⁾						
	1.4 (B/C53A)	59	09.90	12.95	+ Schaltgetriebe ⁵⁾						
	1.7 (B/C53B)	54	09.88	12.95	- ABS						
	1.7 (B/C53B)	54	09.88	12.94	+ ABS/ + Automatikgetriebe ⁴⁾						
	1.7 (B/C53B)	54	09.88	12.95	+ Schaltgetriebe ⁵⁾						
	1.7 (B/C53M)	54	09.88	12.95							
	1.4 (B/C53A)	59	01.95	12.95	+ ABS/ + Automatikgetriebe ⁴⁾	13.0460-2834.2	602834			21463 18,0 /WK/S	LUC
	1.7 (B/C533)	54	09.88	12.95							
	1.7 (B/C53B)	54	01.95	12.95	+ ABS/ + Automatikgetriebe ⁴⁾						
	1.7 (B/C53C/F)		09.88	12.95							

¹⁾ - driving school / - scuola guida / - auto école / - autoescuela

²⁾ - ABS/ - driving school / - ABS/ - scuola guida / - ABS/ - auto-école / - ABS/ - autoescuela

³⁾ + ABS/ + manual transm. / + ABS/+ scatola camb.velocità / + ABS/ + transmission mécanique / + ABS/ + cambio de velocidad

⁴⁾ + ABS/ + autom.transmission / + ABS/ + scatola cambio autom. / + ABS/ + transmission automatique / + ABS/ + cambio automático

⁵⁾ + manual transmission / + scatola cambio velocità / + transmission mécanique / + cambio de velocidad

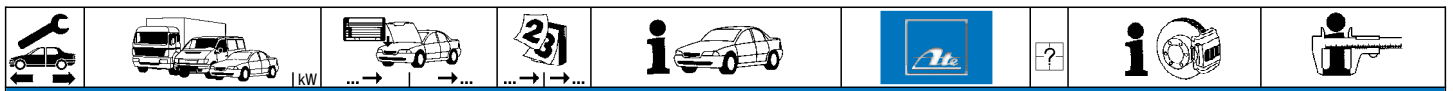

RENAULT R19 (3/5-tuerig) (B53/C53/S53_) (88-95)

	1.8 1.8 1.8 (B/C538) 1.8 16V 1.9 D (B/C534/J) 1.9 dT 1.9 dT (B/C53T)	65 66 99 47 66 66	05.92 09.94 10.91 09.88 09.88 09.90 05.92	12.95 12.95 12.95 12.95 + ABS 12.95 12.95	13.0460-2834.2 602834		21463 18,0 /WK/S	LUC
	1.2 1.4 1.4 (B/C535) 1.4 (B/C53A) 1.4 (B/C53A) 1.4 (B/C53A) 1.7 (B/C536/E) 1.7 (B/C53B) 1.7 (B/C53B) 1.7 (B/C53B) 1.9 D (B/C/S53I) 1.9 D (B/C534/J) 1.9 D (B/C534/J) 1.9 D (S534/J)	40 43 55 59 59 59 54 54 54 47 47 47 47	09.88 09.88 09.94 09.90 09.90 09.90 09.88 09.88 09.88 05.92 09.88 10.91 09.88	12.95 12.95 12.95 12.95 - ABS/ + Automatikgetriebe 1) 12.94 + ABS/ + Automatikgetriebe 2) 12.95 + Schaltgetriebe 3) 12.95 12.95 - ABS/ + Automatikgetriebe 1) 12.94 + ABS/ + Automatikgetriebe 2) 12.95 + ABS/ + Schaltgetriebe 4) 12.95 12.95 - ABS 12.95 + ABS 12.95	24.0112-0116.1 412116		238 12,0 10,5 +S +B	
	1.7 (B/C533) 1.7 (B/C533) 1.7 (B/C533) 1.7 (B/C53C) 1.7 (B/C53C) 1.7 (B/C53C) 1.7 (B/C53F) 1.7 (B/C53M) 1.8 (353/535F) 1.8 (353/535F) 1.8 (B/C53V) 1.8 (B/C53V) 1.8 (B/C53Y) 1.8 4x4 (B/C53Y) 1.8 4x4 (B/C53Y) 1.9 D (B/C534/J) 1.9 dT (B/C53K) 1.9 dT (B/C53K) 1.9 dT (B/C53T) 1.9 dT (B/C53T) 1.9 dT (S53K)	54 54 54 66 66 66 54 54 66 66 66 66 65 65 47 66 66 66 66 66 66	09.88 09.88 09.88 09.88 09.88 09.88 09.90 09.88 09.94 09.94 09.94 09.94 05.92 05.92 09.88 09.90 09.90 05.92 05.92 04.91	12.95 12.94 + ABS/ + Automatikgetriebe 2) 12.95 + ABS/ + Automatikgetriebe 2) 12.95 + Schaltgetriebe 3) 12.95 - ABS/ + Automatikgetriebe 1) 12.94 + ABS/ + Automatikgetriebe 2) 12.95 + Schaltgetriebe 3) 12.95 12.95 12.94 + ABS 12.95 - ABS 12.94 + ABS 12.95 + Schaltgetriebe 3) 12.95 - ABS 12.94 + ABS 12.95 + ABS 12.95 - ABS 12.94 + ABS 12.95	24.0120-0125.1 420125		238 20,1 17,7 V +S +B	
	1.4 (B/C53A) 1.7 (B/C533) 1.7 (B/C53C) 1.8 (353/535F) 1.8 (353A/C/D) 1.8 (553A/C/D/H) 1.8 (B/C/538) 1.8 (B/C/53V) 1.8 16V 1.8 4x4 (B/C53Y) 1.9 dT (B/C53K) 1.9 dT (B/C53T)	59 54 66 66 66 66 66 66 99 65 66 66	01.95 01.95 01.95 01.95 09.94 09.94 10.91 01.95 09.88 01.95 01.95 01.95	12.95 + ABS/ + Automatikgetriebe 2) 12.95 + ABS/ + Automatikgetriebe 2) 12.95 + ABS/ + Automatikgetriebe 2) 12.95 + ABS 12.95 12.95 12.95 + ABS 12.95 12.95 + ABS 12.95 + ABS 12.95 + ABS 12.95 + ABS	24.0121-0106.1 421106		259 20,6 17,7 V +S +B	
	1.2 1.4 1.4 (B/C535) 1.7 1.7 1.8 1.8 1.8 1.8 16V 1.9 D 1.9 dT	40 43 55 54 66 65 66 81 99 47 66	09.88 09.88 09.90 09.88 09.88 05.92 09.94 10.91 09.88 09.88 09.90	12.95 12.95 12.95 12.95 12.95 12.95 12.95 12.95 12.95 12.95 + ABS 12.95	24.5111-0280.3 330389	2	L=280	
	1.4 (B/C535) 1.7 1.7 1.7 1.8 1.8 1.8 1.8 1.8 1.8 16V 1.9 D 1.9 dT	55 54 66 79 65 66 79 81 99 47 66	09.94 09.88 09.88 05.92 05.92 09.94 09.94 10.91 09.88 09.88 09.90	12.95 + ABS 12.95 + ABS 12.95 + ABS 09.94 + ABS 12.95 + ABS 12.95 + ABS 12.95 + ABS 12.95 + ABS 12.95 12.95 + ABS 12.95 + ABS 12.95 + ABS	13.0460-3822.2 603822		21597 11,0 +/S	BDX
	1.4 (B/C535) 1.7 1.7 (B/C533) 1.7 (B/C53F) 1.7 (B/C53M) 1.7 (C53C/F) 1.8 1.8 1.8 (353/535F) 1.8 (B/C53V) 1.8 (B/C53Y)	55 79 54 54 54 79 81 66 66 66 65	09.94 05.92 09.88 06.89 09.88 09.88 09.94 10.91 11.94 09.94 05.92	12.95 + ABS 12.95 + ABS 12.95 + ABS 12.95 + ABS 12.95 + ABS 12.95 + ABS 12.95 + ABS 12.95 + ABS 12.95 + ABS 12.95 + ABS 12.95 + ABS	24.0108-0108.1 408108	ohne Sensorring 5)	238 8,0 7,0 +B	

1) - ABS/ + autom.transmission / - ABS/ + scatola cambio autom. / - ABS/ + transmission automatique / - ABS/ + cambio automático
 2) + ABS/ + autom.transmission / + ABS/ + scatola cambio autom. / + ABS/ + transmission automatique / + ABS/ + cambio automático
 3) + manual transmission / + scatola cambio velocità / + transmission mécanique / + cambio de velocidad
 4) + ABS/ + manual transm. / + ABS/+ scatola camb.velocità / + ABS/ + transmission mécanique / + ABS/ + cambio de velocidad
 5) without sensor ring / senza sensori / sans secours ABS / sin anillo sensor ABS



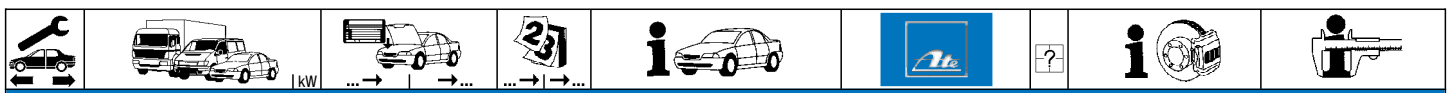

RENAULT R19 (3/5-tuerig) (B53/C53/S53_) (88-95)

	1.8 (B553A/C/D)	66	09.94	12.95 + ABS	24.0108-0108.1	408108		ohne Sensorring ¹⁾	238 8,0 7,0 +B							
	1.8 (C353A/C/D)	66	09.94	12.95 + ABS												
	1.8 16V (B/C539)	99	09.88	12.95												
	1.8 16V (B/C53D)	99	06.89	12.95												
	1.8 16V (B/C53D)	99	05.93	12.95 + Klimaanlage ²⁾												
	1.9 D (B/C534)	47	09.88	12.95 + ABS												
	1.9 D (B/C53I/J)	47	09.90	12.95 + ABS												
	1.9 dT (B/C53K)	66	09.90	12.95 + ABS												
	1.9 dT (B/C53T)	66	05.92	12.95 + ABS												
		1.2	40	09.88						12.95	24.5229-0240.3	330400	2	Länge beachten ³⁾	L=242	
1.4		43	09.88	12.95												
1.4		55	09.90	12.95 - ABS	24.5229-0255.3	330581	2	Länge beachten ³⁾	L=255							
1.7		54	09.88	12.95 - ABS												
1.7		66	09.88	12.95 - ABS												
1.8		65	05.92	12.95 - ABS												
1.8		66	09.94	12.95 - ABS												
1.8		81	10.91	12.95 - ABS												
1.8 16V		99	09.88	12.95 - ABS												
1.9 D		47	09.88	12.95 - ABS												
1.9 dT		66	09.90	12.95 - ABS												
1.4		55	09.90	12.95 + ABS						24.5229-0220.3	330399	2		L=220		
1.7		54	09.88	12.95 + ABS												
1.7		66	09.88	12.95 + ABS												
1.8		65	05.92	12.95 + ABS												
1.8		66	09.94	12.95 + ABS												
1.8		81	10.91	12.95 + ABS												
1.8 16V		99	09.88	12.95 + ABS												
1.9 D		47	09.88	12.95 + ABS												
1.9 dT		66	04.91	12.95 + ABS												
	1.2	40	09.88	04.91	24.3220-1618.3	020245			RzR 20,64						BDX	
	1.4	43	09.88	04.91												
	1.4	59	09.90	04.91 - ABS	24.3220-1617.3	020244			RzR 20,64	BDX						
	1.7 (B/C533/536)	54	09.88	04.91 - ABS												
	1.7 (B/C53C/F)	54	09.88	04.91 - ABS												
	1.7 (B/C53E/M)	54	09.88	12.95												
	1.9 D (B/C534/J)	47	09.88	04.91 - ABS												
	1.9 D (S534)	47	09.88	04.91												
	1.9 dT (B/-53K)	66	09.90	04.91 - ABS												
	1.2	40	05.91	12.95							24.3220-1617.3	020244			RzR 20,64	BDX
	1.4	43	05.91	12.95												
	1.4	59	05.91	12.95 - ABS							24.3220-1618.3	020245			RzR 20,64	BDX
	1.7 (B/C533/536)	54	05.91	12.95 - ABS												
	1.7 (B/C53C/F)	54	05.91	12.95 - ABS												
	1.9 D (B/C534/J)	47	05.91	12.95 - ABS												
	1.9 D (S534/J)	47	05.91	12.95												
	1.9 dT (B/-53K)	66	05.91	04.92 - ABS												
	1.9 dT (S53K)	66	05.91	12.95												
	1.2	40	05.92	12.95	24.3220-1617.3	020244			RzR 20,64	BDX						
	1.4	59	09.94	12.95 - ABS												
	1.4 (B/C535)	55	09.94	12.95 - ABS	24.3220-1618.3	020245			RzR 20,64	BDX						
	1.8 (353/535/A/F)	66	09.94	12.95 - ABS												
	1.8 (B/C53V)	66	09.94	12.95 - ABS	24.3220-1615.3	020242			RzR 20,64	LUC						
	1.8 (B/C53Y)	65	05.92	12.95 - ABS												
1.9 D (B/C53I)	47	05.92	12.95 - ABS													
1.9 D (S53I)	47	05.92	12.95													
1.9 dT (-/C53K)	66	10.91	04.92 - ABS													
1.2	40	09.88	12.95							24.3220-1615.3	020242			RzR 20,64	LUC	
1.4 (B/C532)	43	09.88	12.95													
1.7 (B/C533)	54	09.88	12.95 - ABS							24.3220-1616.3	020243			RzR 20,64	LUC	
1.7 (B/C53C/F)	54	09.88	12.95 - ABS													
1.7 (B536)	54	09.88	12.95													
1.9 D (B/C534/J)	47	09.88	12.95 - ABS													
1.9 D (S534/J)	47	09.88	12.95													
1.9 dT (B/C53K)	66	09.90	04.92 - ABS													
1.2	40	09.88	12.95	03.0137-0209.2	650209			180 x 42	BDX							
1.4	43	09.88	12.95													
1.4	59	09.94	12.95 - ABS	03.0137-9086.2	669086			180 x 41 HEB	BDX							
1.4 (B/C535)	55	09.94	12.95 - ABS													
1.7	54	09.88	12.95 - ABS	03.0137-0201.2	650201			180 x 41 HEB	LUC							
1.7 (B/C53C/F)	54	09.88	12.95 - ABS													
1.8	65	05.92	12.95 - ABS	03.0137-9056.2	669056											
1.8 (353/535/A/F)	66	09.94	12.95 - ABS													
1.8 (B/C53V)	66	09.94	12.95 - ABS													
1.9 D (B/C534/I/J)	47	09.88	12.95 - ABS													
1.9 D (S534/I/J)	47	09.88	12.95													
1.9 dT (B/C53K)	66	09.90	04.92 - ABS													
1.9 dT (S53K)	66	04.91	12.95													
1.7 (B/C53F)	66	09.90	12.95 - ABS							03.0137-0211.2	650211			203 x 39	BDX	
1.8 (353C/D)	66	09.94	12.95 - ABS													
1.8 (553C/D/H)	66	09.94	12.95 - ABS							03.0137-9125.2	669125			203 x 39	BDX	
1.8 (B/C538)	66	10.91	12.95 - ABS													
1.9 dT (B/C53K)	66	05.92	12.95 - ABS													
1.9 dT (B/C53T)	66	05.92	12.95 - ABS													

¹⁾ without sensor ring / senza sensori / sans secours ABS / sin anillo sensor ABS
²⁾ + air conditioning / + aria condizionata / + air conditionné / + aire acondicionado
³⁾ notice length / attenzione lunghezza / faire attention longueur / atención largo



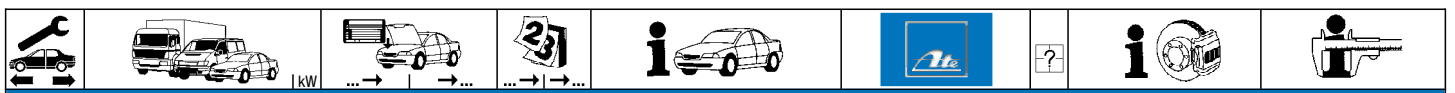

RENAULT R19 (3/5-tuerig) (B53/C53/S53_) (88-95)

	1.2	40	09.88	12.95	24.0218-0032.1	480118		180/181 x 53,5 - Lager 180/181 x 53,2 + Lager	
	1.4	43	09.88	12.95	24.0218-0732.2	480207			
	1.4	59	09.90	12.95	- ABS				
	1.4 (B/C535)	55	09.90	12.95	- ABS				
	1.7	54	09.88	12.95	- ABS				
	1.7 (B/C53C/F)		09.88	12.95	- ABS				
	1.8 (353/553A)	66	09.94	12.95	- ABS				
	1.8 (B/C53V)	66	09.94	12.95	- ABS				
	1.8 (B/C53Y)	65	05.92	12.95	- ABS				
	1.9 D (B/C534/I/J)	47	09.88	12.95	- ABS				
1.9 D (S534/I/J)	47	09.88	12.95						
1.9 dT (B/C53K)	66	09.90	04.92	- ABS					
1.9 dT (S53K)	66	04.91	04.92						
1.7 (B/C53F)		05.92	12.95	- ABS	24.0220-3021.1	480127		203/204,5 x 50,5 - Lager	
1.8 (B/C538)		10.91	12.95	- ABS					
1.8 (B53C/D/F/H)	66	09.94	12.95	- ABS					
1.8 (C353C/D/F)		09.94	12.95	- ABS					
1.9 dT (B/C53K)	66	05.92	12.95	- ABS					
1.9 dT (B/C53T)	66	05.92	12.95	- ABS					
	1.2	40	09.88	04.91	03.0520-2020.3	692020		20,64/180x42 TopKit BDX	
	1.4	43	09.88	04.91					
	1.4	59	09.90	04.91	- ABS				
	1.7 (B/C533/536)	54	09.88	04.91	- ABS				
	1.7 (B/C53C/F)		09.88	04.91	- ABS				
	1.7 (B/C53E/M)	54	09.88	12.95					
	1.9 D (B/C534/J)	47	09.88	04.91	- ABS				
	1.9 D (S534)	47	09.88	04.91					
	1.9 dT (B/-53K)	66	09.90	04.91	- ABS				
	1.2	40	05.92	12.95		03.0520-2020.3	692020	20,64/180x42 TopKit BDX	
1.4	59	09.94	12.95	- ABS	03.0520-2920.3	692920	20,64/180x41 TopKit LUC		
1.4 (B/C535)	55	09.94	12.95	- ABS					
1.8 (353/535/A/F)	66	09.94	12.95	- ABS					
1.8 (B/C53V)	66	09.94	12.95	- ABS					
1.8 (B/C53Y)	65	05.92	12.95	- ABS					
1.9 D (B/C53I)	47	05.92	12.95	- ABS					
1.9 D (S53I)	47	05.92	12.95						
1.9 dT (-/C53K)	66	10.91	04.92	- ABS					
1.2	40	09.88	12.95		03.0520-2920.3	692920		20,64/180x41 TopKit LUC	
1.4	43	09.88	12.95						
1.7 (B/C533)	54	09.88	12.95	- ABS					
1.7 (B/C53C/F)		09.88	12.95	- ABS					
1.7 (B536)	54	09.88	12.95						
1.9 D (B/C534/J)	47	09.88	12.95	- ABS					
1.9 D (S534/J)	47	09.88	12.95						
1.9 dT (B/C53K)	66	09.90	04.92	- ABS					
1.7 (B/C53F)		09.90	12.95	- ABS	03.0520-1919.3	691919		19,05/203x39 TopKit BDX	
1.8 (353C/D)		09.94	12.95	- ABS					
1.8 (553C/D/H)		09.94	12.95	- ABS					
1.8 (B/C538)		10.91	12.95	- ABS					
1.9 dT (B/C53K)	66	05.92	12.95	- ABS					
1.9 dT (B/C53T)	66	05.92	12.95	- ABS					
	1.2	40	09.88	12.95	24.3727-1012.2	581012	2 ↓	L=1564	
	1.4	43	09.88	12.95					
	1.4	59	09.90	12.95	- ABS				
	1.4 (B/C535)	55	09.90	12.95	- ABS				
	1.7	54	09.88	12.95	- ABS				
	1.7	66	09.88	12.95	- ABS				
	1.8	65	05.92	12.95	- ABS				
	1.8	66	09.94	12.95	- ABS				
	1.8	81	10.91	12.95	- ABS				
	1.9 D	47	09.88	12.95	- ABS				
1.9 dT	66	09.90	12.95	- ABS					
1.4 (B/C535)	55	09.90	12.95	+ ABS	24.3727-1011.2	581011	2 ↓	L=1564	
1.7	54	09.88	12.95	+ ABS					
1.7	66	09.88	12.95	+ ABS					
1.8	65	05.92	12.95	+ ABS					
1.8	66	09.94	12.95	+ ABS					
1.8	81	10.91	12.95	+ ABS					
1.8 16V	99	09.88	12.95						
1.9 D	47	09.88	12.95	+ ABS					
1.9 dT	66	09.90	12.95	+ ABS					
	1.7 (B/C53F)		12.94	12.95	- ABS	24.6583-1710.3	320166		BRL (4)
	1.8 (353C/D)		12.94	12.95	- ABS				
	1.8 (553C/D/H)		12.94	12.95	- ABS				
	1.8 (B/C538)		12.94	12.95	- ABS				
	1.9 D (B/C53Z)	47	09.94	12.95	- ABS				
	1.9 dT (B/C53K)	66	12.94	12.95	- ABS				
	1.9 dT (B/C53T)	66	12.94	12.95	- ABS				
1.9 dT (S53K)	66	12.94	12.95						
	1.2	40	09.88	12.95	24.3728-1005.2	591005		L=1010	
	1.4	43	09.88	12.95					
	1.4	55	09.90	12.95					
	1.4	59	09.90	12.95					
	1.7	54	09.88	12.95					
	1.7	66	09.88	12.95					
	1.8	65	05.92	12.95					



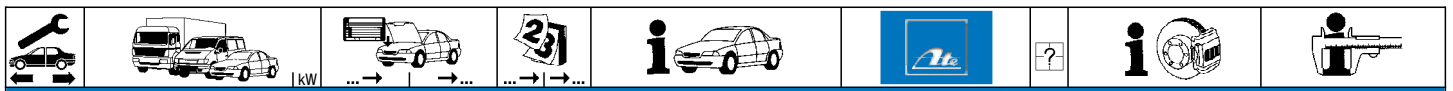

RENAULT R19 (3/5-tuerig) (B53/C53/S53_) (88-95)

	1.8	66	09.94	12.95	24.3728-1005.2	591005		L=1010
	1.8	81	10.91	12.95				
	1.8 16V	99	09.88	12.95				
	1.9 D	47	09.88	12.95				
	1.9 dT	66	09.90	12.95				

RENAULT R19 CHAMADE (L53_) (89-95)

	1.2	40	06.89	01.92	03.2119-3389.3	010057		ThZ 19,05	ATE
	1.4	43	05.89	01.92					
	1.4 (L537)		05.89	01.92	+ Fahrschule 1)				
	1.4 (L53A)		09.90	01.92	- ABS				
	1.4 (L53A)		02.92	12.95	- ABS/ + Fahrschule 2)				
	1.4 (L53P)	43	05.89	12.95					
	1.7	66	05.89	01.92	- ABS				
	1.7	66	02.92	12.95	- ABS/ + Fahrschule 2)				
	1.7 (L533)	54	05.89	01.92	- ABS				
	1.7 (L533)	54	02.92	12.95	- ABS/ + Fahrschule 2)				
	1.7 (L536)	54	06.89	12.95					
	1.9 D (L534/J)	47	05.89	01.92	- ABS				
	1.9 D (L534/J)	47	02.92	12.95	- ABS/ + Fahrschule 2)				
	1.9 dT	66	04.91	01.92	- ABS				
	1.9 dT	66	02.92	12.95	- ABS/ + Fahrschule 2)				
	1.9 TD (L53K)	68	09.90	01.92	- ABS				
	1.2	40	02.92	12.92	03.2120-2031.3	010106		ThZ 20,64	ATE
	1.4	43	02.92	12.95					
	1.4 (L535)	55	09.94	12.95	- ABS				
	1.4 (L537)		02.92	12.95	- Fahrschule 3)				
	1.4 (L53A)		02.92	12.95	- ABS/ - Fahrschule 4)				
	1.4 (L53G)		05.92	12.95					
	1.7 (L533)	54	02.92	12.95	- ABS/ - Fahrschule 4)				
	1.7 (L53C)	66	02.92	12.95	- ABS/ - Fahrschule 4)				
	1.7 (L53F)	79	02.92	12.95	- ABS				
	1.8	65	05.92	12.95	- ABS				
	1.8	79	05.92	12.95	- ABS				
	1.8 (L453A/C/D)	66	09.94	12.95	- ABS				
	1.8 (L538)	81	05.92	12.95	- ABS				
	1.8 (L53V/453/F/H)	66	09.94	12.95					
	1.8 16V	99	05.89	12.95	- ABS				
	1.9 D (L534/J)	47	02.92	12.95	- ABS/ - Fahrschule 4)				
	1.9 D (L53I)	47	05.92	12.95	- ABS				
	1.9 dT	66	02.92	12.95	- ABS/ - Fahrschule 4)				
	1.9 TD (L53K)	68	02.92	04.92	- ABS				
	1.4	55	09.94	12.95	24.2120-1725.3	010579		ThZ 20,64	BDX
	1.7	54	05.89	12.95	+ ABS/ + Schaltgetriebe 5)				
	1.7	66	05.89	12.95	+ ABS/ + Schaltgetriebe 5)				
	1.7	66	05.89	12.95	+ ABS/ + Schaltgetriebe 5)				
	1.8	65	05.92	12.95	+ ABS/ + Schaltgetriebe 5)				
	1.8	66	09.94	12.95	+ ABS/ + Schaltgetriebe 5)				
	1.8	79	05.92	12.95	+ ABS/ + Schaltgetriebe 5)				
	1.8 (L538)	81	05.92	12.95	+ ABS/ + Schaltgetriebe 5)				
	1.8 16V	99	05.89	12.95	+ ABS/ + Schaltgetriebe 5)				
	1.9 D	47	05.89	12.95	+ ABS/ + Schaltgetriebe 5)				
	1.9 dT	66	10.95	12.95	+ ABS/ + Schaltgetriebe 5)				
	1.9 TD (L53K)	68	09.90	04.92	+ ABS/ + Schaltgetriebe 5)				
	1.2	40	06.89	12.92	24.3481-1505.5	240047		D=48, - Halter	BDX
	1.4	43	05.89	12.95	24.3481-1506.5	240048		D=48, - Halter	BDX
	1.4 (L535)	55	09.94	12.95	24.3481-1611.5	240029		D=48, - Halter	LUC
	1.7 (L536)	54	06.89	12.95	24.3481-1612.5	240030		D=48, - Halter	LUC
	1.9 D (L534/J)	47	05.89	12.95	24.0101-4803.2	260049		Bremssattel-Zubehör	BDX
	1.9 D (L534/J)	47	10.91	12.95	24.0101-4807.2	260053		Bremssattel-Zubehör	LUC
	1.9 D (L53I)	47	05.92	12.95					
	1.4 (L53A)		09.90	12.95	24.3481-1505.5	240047		D=48, - Halter	BDX
	1.7 (L53B)	54	05.89	12.95	24.3481-1506.5	240048		D=48, - Halter	BDX
					24.0101-4803.2	260049		Bremssattel-Zubehör	BDX
	1.4 (L53A)		09.90	12.95	24.3481-1611.5	240029		D=48, - Halter	LUC
	1.4 (L53A)		09.90	12.95	24.3481-1612.5	240030		D=48, - Halter	LUC
	1.4 (L53A)		09.90	12.95	24.0101-4807.2	260053		Bremssattel-Zubehör	LUC
	1.7 (L53B)	54	05.89	12.95	- ABS				
	1.7 (L53B)	54	05.89	12.94	+ ABS/ + Automatikgetriebe 6)				
	1.7 (L53B)	54	05.89	12.95	+ Schaltgetriebe 7)				
	1.4 (L53A)		01.95	12.95	24.3481-1615.5	240031		D=48, - Halter	LUC
	1.7 (L533)	54	05.89	12.95	24.3481-1616.5	240032		D=48, - Halter	LUC
	1.7 (L53B)	54	01.95	12.95	24.0101-4806.2	260052		Bremssattel-Zubehör	LUC
	1.7 (L53C/F)		05.89	12.95					
	1.8	65	05.92	12.95					
	1.8	66	11.94	12.95					
	1.8	79	05.92	12.95					
	1.8 (L538)	81	05.92	12.95					
	1.8 16V	99	05.89	12.95					
	1.9 D (L534/J)	47	05.89	09.91	+ ABS				
	1.9 D (L53Z)	47	05.92	12.95					
	1.9 dT	66	04.91	12.95					
	1.2	40	06.89	12.92	13.0460-3911.2	603911		20905 18,0 +/WK	BDX
	1.4	43	05.89	12.95	13.0460-2834.2	602834		21463 18,0 /WK/S	LUC
	1.4 (L535)	55	09.94	12.95	13.0460-0411.2	610411		Belagsatz-Zubehör	BDX
	1.7 (L536)	54	06.89	12.95					

1) + driving school / + scuola guida / + auto école / + autoescuela
 2) - ABS/ + driving school / - ABS/ + scuola guida / - ABS/ + auto école / - ABS/ + autoescuela
 3) - driving school / - scuola guida / - auto école / - autoescuela
 4) - ABS/ - driving school / - ABS/ - scuola guida / - ABS/ - auto école / - ABS/ - autoescuela
 5) + ABS/ + manual transm. / + ABS/+ scatola camb.velocità / + ABS/ + transmission mécanique / + ABS/ + cambio de velocidad
 6) + ABS/ + autom.transmission / + ABS/+ scatola cambio autom. / + ABS/ + transmission automatique / + ABS/ + cambio automático
 7) + manual transmission / + scatola cambio velocità / + transmission mécanique / + cambio de velocidad

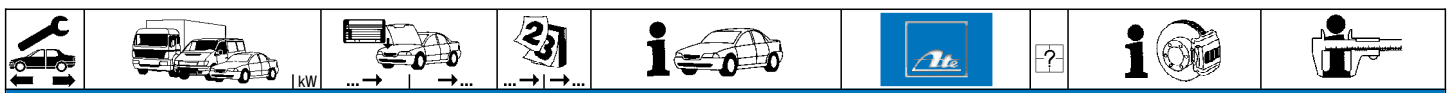

RENAULT R19 CHAMADE (L53_) (89-95)

	1.9 D (L534/J)	47	05.89	12.95	- ABS	13.0460-3911.2	603911		20905	18,0 +/WK	BDX
	1.9 D (L534/J)	47	10.91	12.95	+ ABS	13.0460-2834.2	602834		21463	18,0 /WK/S	LUC
	1.9 D (L53I)	47	05.92	12.95		13.0460-0411.2	610411			Belagsatz-Zubehör	BDX
	1.4 (L53A)		09.90	12.95		13.0460-3911.2	603911		20905	18,0 +/WK	BDX
	1.7 (L53B)	54	05.89	12.95		13.0460-0411.2	610411			Belagsatz-Zubehör	BDX
	1.4 (L53A)		09.90	12.95	- ABS	13.0460-2834.2	602834		21463	18,0 /WK/S	LUC
	1.4 (L53A)		09.90	12.95	+ ABS/ + Automatikgetriebe ¹⁾						
	1.4 (L53A)		09.90	12.95	+ Schaltgetriebe ²⁾						
	1.7 (L533)	54	05.89	12.95							
	1.7 (L53B)	54	05.89	12.95	- ABS						
	1.7 (L53B)	54	05.89	12.95	+ ABS/ + Automatikgetriebe ¹⁾						
	1.7 (L53B)	54	05.89	12.95	+ Schaltgetriebe ²⁾						
	1.7 (L53C/F)		05.89	12.95							
	1.8	65	05.92	12.95							
	1.8	66	11.94	12.95							
	1.8	79	05.92	12.95							
	1.8 (L538)	81	05.92	12.95							
	1.8 16V	99	05.89	12.95							
	1.9 D (L534/J)	47	05.89	09.91	+ ABS						
	1.9 D (L53Z)	47	05.92	12.95							
	1.9 dT	66	04.91	12.95							
	1.9 TD (L53K)	68	09.90	04.92							
	1.2	40	06.89	12.92		24.0112-0116.1	412116			238 12,0 10,5 +S +B	
	1.4	43	05.89	12.95							
	1.4 (L535)	55	09.94	12.95							
	1.4 (L53A)		09.90	12.95	+ Schaltgetriebe ²⁾						
	1.4 (L53A)		09.90	12.95	- ABS/ + Automatikgetriebe ³⁾						
	1.4 (L53A)		09.90	12.94	+ ABS/ + Automatikgetriebe ¹⁾						
	1.7 (L536)	54	06.89	12.95							
	1.7 (L53B)	54	05.89	12.95	+ Schaltgetriebe ²⁾						
	1.7 (L53B)	54	05.89	12.95	- ABS/ + Automatikgetriebe ³⁾						
	1.7 (L53B)	54	05.89	12.94	+ ABS/ + Automatikgetriebe ¹⁾						
	1.9 D (L534/J)	47	05.89	12.95	- ABS						
	1.9 D (L534/J)	47	10.91	12.95	+ ABS						
	1.9 D (L53I)	47	05.92	12.95							
	1.7 (L533)	54	05.89	12.95	+ Schaltgetriebe ²⁾	24.0120-0125.1	420125			238 20,1 17,7 V +S +B	
	1.7 (L533)	54	05.89	12.95	- ABS/ + Automatikgetriebe ³⁾						
	1.7 (L533)	54	05.89	12.94	+ ABS/ + Automatikgetriebe ¹⁾						
	1.7 (L53C)	66	05.89	12.95	+ Schaltgetriebe ²⁾						
	1.7 (L53C)	66	05.89	12.95	- ABS/ + Automatikgetriebe ³⁾						
	1.7 (L53C)	66	05.89	12.94	+ ABS/ + Automatikgetriebe ¹⁾						
	1.8	65	05.92	12.95	+ Schaltgetriebe ²⁾						
	1.8	65	05.92	12.95	- ABS/ + Automatikgetriebe ³⁾						
	1.8	65	05.92	12.94	+ ABS/ + Automatikgetriebe ¹⁾						
	1.8 (L53V/453F)	66	09.94	12.95	- ABS						
	1.8 (L53V/453F)	66	09.94	12.94	+ ABS						
	1.9 D (L534/J)	47	05.89	09.91	+ ABS						
	1.9 D (L53Z)	47	05.92	12.95	- ABS						
	1.9 D (L53Z)	47	05.92	12.94	+ ABS						
	1.9 dT	66	04.91	12.95	- ABS						
	1.9 dT	66	04.91	12.94	+ ABS						
	1.9 TD (L53K)	68	09.90	04.92							
	1.4 (L53A)		01.95	12.95	+ ABS/ + Automatikgetriebe ¹⁾	24.0121-0106.1	421106			259 20,6 17,7 V +S +B	
	1.7 (L533)	54	01.95	12.95	+ ABS/ + Automatikgetriebe ¹⁾						
	1.7 (L53C)	66	01.95	12.95	+ ABS/ + Automatikgetriebe ¹⁾						
	1.7 (L53F)	79	09.90	12.95							
	1.8	65	01.95	12.95	+ ABS/ + Automatikgetriebe ¹⁾						
	1.8	79	05.92	12.95							
	1.8 (L453A/C/D/H)	66	09.94	12.95							
	1.8 (L538)	81	05.92	12.95							
	1.8 (L53V/453F)	66	01.95	12.95	+ ABS						
	1.8 16V	99	05.89	12.95							
	1.9 D (L53Z)	47	01.95	12.95	+ ABS						
	1.9 dT	66	01.95	12.95	+ ABS						
	1.2	40	06.89	12.92		24.5111-0280.3	330389	2		L=280	
	1.4	43	05.89	12.95							
	1.4	43	05.89	12.95							
	1.4	55	05.89	12.95							
	1.7	54	05.89	12.95							
	1.7	66	05.89	12.95							
	1.8	65	05.92	12.95							
	1.8	66	09.94	12.95							
	1.8	79	05.92	12.95							
	1.8 (L538)	81	05.92	12.95							
	1.8 16V	99	05.89	12.95							
	1.9 D	47	05.89	12.95							
	1.9 dT	66	04.91	12.95							
	1.9 TD (L53K)	68	09.90	04.92							
	1.4	55	09.90	12.95	+ ABS	13.0460-3822.2	603822			21597 11,0 +/S	BDX
	1.7	54	05.89	12.95	+ ABS						
	1.7	66	05.89	12.95	+ ABS						
	1.8	65	07.91	12.95	+ ABS						
	1.8	66	09.94	12.95	+ ABS						
	1.8	79	05.92	12.95	+ ABS						
	1.8 (L538)	81	05.92	12.95	+ ABS						
	1.8 16V	99	05.89	12.95							

¹⁾ + ABS/ + autom.transmission / + ABS/ + scatola cambio autom. / + ABS/ + transmission automatique / + ABS/ + cambio automático

²⁾ + manual transmission / + scatola cambio velocità / + transmission mécanique / + cambio de velocidad

³⁾ - ABS/ + autom.transmission / - ABS/ + scatola cambio autom. / - ABS/ + transmission automatique / - ABS/ + cambio automático



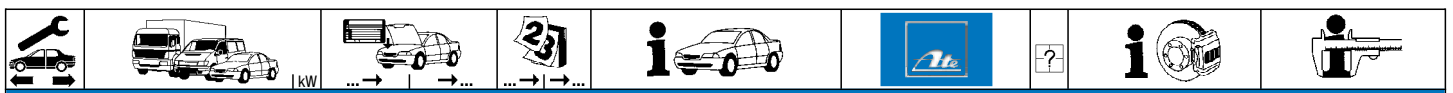







RENAULT R19 CHAMADE (L53_) (89-95)

	1.9 D 1.9 dT 1.9 TD (L53K)	47 66 68		05.89 04.91 09.90	12.95 + ABS 12.95 + ABS 04.92	13.0460-3822.2	603822			21597 11,0 +/S	BDX
	1.4 1.7 1.7 (L53C) 1.7 (L53F) 1.8 1.8 1.8 (L453A/C/D) 1.8 (L538) 1.8 (L53V/453F) 1.8 16V (L539) 1.8 16V (L53D) 1.8 16V (L53D) 1.9 D (L534) 1.9 D (L531/J) 1.9 D (L53Z) 1.9 dT 1.9 TD (L53K)	55 54 66 79 65 79 66 81 66 99 99 99 47 47 47 66 68		09.90 05.89 05.89 09.90 05.92 05.92 09.94 05.92 09.94 05.89 06.89 05.93 05.89 09.90 05.92 04.91 09.90	12.95 + ABS 12.95 + ABS 12.95 + ABS 12.95 + ABS 12.95 + ABS 12.95 + ABS 12.95 + ABS 12.95 + ABS 12.95 + ABS 12.95 04.93 + ABS 12.95 + ABS/ + Klimaanlage 2) 12.95 + ABS 12.95 + ABS 12.95 + ABS 12.95 + ABS 12.95 + ABS 12.95 + ABS 12.95 + ABS 12.95 + ABS 04.92	24.0108-0108.1	408108		ohne Sensorring 1)	238 8,0 7,0 +B	
	1.2 1.4 1.4 1.4 1.7 1.7 (L53C) 1.8 1.8 (L53V/453A/F/H) 1.8 16V 1.9 D 1.9 dT 1.4 1.7 1.7 (L53C) 1.7 (L53F) 1.8 1.8 1.8 (L538) 1.9 D 1.9 dT 1.9 TD (L53K)	40 43 55 54 66 65 66 99 47 66 55 54 66 79 65 66 79 81 47 66 68		06.89 05.89 05.89 09.94 05.89 05.89 05.92 09.94 05.89 05.89 04.91 09.90 05.89 05.89 09.90 05.92 09.94 05.92 04.91 09.90	12.92 12.95 12.95 12.95 12.95 - ABS 12.95 - ABS 12.95 - ABS 12.95 - ABS 12.95 - ABS 12.95 - ABS 12.95 - ABS 12.95 + ABS 12.95 + ABS 12.95 + ABS 12.95 + ABS 12.95 + ABS 12.95 + ABS 12.95 + ABS 12.95 + ABS 12.95 + ABS 04.92	24.5229-0240.3 24.5229-0255.3	330400 330581	2 2	Länge beachten 3) Länge beachten 3)	L=242 L=255	
	1.2 1.4 1.4 (L537/53H) 1.4 (L53A) 1.4 (L53P) 1.7 (L533/536) 1.7 (L53C) 1.9 D (L534/J)	40 43 43 54 66 47		06.89 05.89 05.89 09.90 05.89 05.89 05.89 05.89	04.91 04.91 04.91 12.95 - ABS 12.95 04.91 - ABS 04.91 - ABS 04.91 - ABS	24.3220-1618.3 24.3220-1617.3	020245 020244	 		RzR 20,64 RzR 20,64	BDX BDX
	1.2 1.4 1.4 (L537/53H) 1.4 (L53A) 1.7 (L533/536) 1.7 (L53C) 1.9 D (L534/J)	40 43 54 66 47		05.91 05.91 05.91 05.91 05.91 05.91 05.91	12.92 12.95 12.95 12.95 - ABS 12.95 - ABS 12.95 - ABS 12.95 - ABS	24.3220-1617.3 24.3220-1618.3	020244 020245	 		RzR 20,64 RzR 20,64	BDX BDX
	1.4 (L535) 1.4 (L53G) 1.8 1.8 (L53V/453A/F) 1.9 D (L531) 1.9 dT	55 65 66 47 66		09.94 05.92 05.92 09.94 05.92 04.91	12.95 - ABS 12.95 12.95 - ABS 12.95 - ABS 12.95 - ABS 04.92 - ABS	24.3220-1617.3 24.3220-1618.3 24.3220-1615.3 24.3220-1616.3	020244 020245 020242 020243	 		RzR 20,64 RzR 20,64 RzR 20,64 RzR 20,64	BDX BDX LUC LUC
	1.4 1.4 (L537/53H) 1.4 (L53A) 1.7 1.7 (L53C) 1.9 D (L534/J)	43 54 66 47		05.89 09.90 05.89 05.89 05.89 05.89	12.95 12.95 12.95 - ABS 12.95 - ABS 12.95 - ABS 12.95 - ABS	24.3220-1615.3 24.3220-1616.3	020242 020243	 		RzR 20,64 RzR 20,64	LUC LUC
	1.2 1.4 1.4 1.4 1.7 (L533/536) 1.7 (L53C) 1.8 1.8 (L53V/453A/F) 1.9 D (L534/I/J) 1.9 dT	40 43 55 54 66 65 66 47 66		06.89 05.89 05.89 09.94 05.89 05.89 05.92 09.94 05.89 04.91	12.92 12.95 12.95 12.95 - ABS 12.95 - ABS 12.95 - ABS 12.95 - ABS 12.95 - ABS 12.95 - ABS 04.92 - ABS	03.0137-0209.2 03.0137-9086.2 03.0137-0201.2 03.0137-9056.2	650209 669086 650201 669056		180 x 42 Bremsbacken-Zubehör 180 x 41 HEB Bremsbacken-Zubehör	BDX BDX LUC LUC	
	1.7 (L53F) 1.8 1.8 (453C/D/H) 1.9 D (L53Z) 1.9 dT	79 79 66 47 66		09.90 05.92 09.94 05.92 05.92	12.95 - ABS 12.95 - ABS 12.95 - ABS 12.95 - ABS 12.95 - ABS	03.0137-0211.2 03.0137-9125.2	650211 669125			203 x 39 Bremsbacken-Zubehör	BDX BDX

1) without sensor ring / senza sensori / sans secours ABS / sin anillo sensor ABS

2) + ABS/ + air conditioning / + ABS/ + aria condizionata / + ABS/ + air conditionné / + ABS/ + aire acondicionado

3) notice length / attenzione lunghezza / faire attention longueur / atención largo

RENAULT R19 CHAMADE (L53_) (89-95)										
	1.2	40		06.89	12.92	24.0218-0032.1	480118			180/181 x 53,5 - Lager
	1.4			05.89	12.95	24.0218-0732.2	480207			180/181 x 53,2 + Lager
	1.4	43		05.89	12.95					
	1.4	55		09.94	12.95					
	1.7	54		05.89	12.95					
	1.7 (L53C)	66		05.89	12.95					
	1.8	65		05.92	12.95					
	1.8 (L53V/453A/F)	66		09.94	12.95					
	1.9 D (L534/I/J)	47		05.89	12.95					
	1.9 dT	66		04.91	04.92					
	1.7 (L53F)	79		09.90	12.95	24.0220-3021.1	480127			203/204,5 x 50,5 - Lager
	1.8	79		05.92	12.95					
	1.8 (453C/D/H)	66		09.94	12.95					
	1.9 D (L53Z)	47		05.92	12.95					
	1.9 dT	66		05.92	12.95					
	1.2	40		06.89	04.91	03.0520-2020.3	692020			20,64/180x42 TopKit BDX
	1.4	43		05.89	04.91					
	1.4 (L537/53H)			05.89	04.91					
	1.4 (L53A)			09.90	04.91					
	1.4 (L53P)	43		05.89	12.95					
1.7 (L533/536)	54		05.89	04.91						
1.7 (L53C)	66		05.89	04.91						
1.9 D (L534/J)	47		05.89	04.91						
	1.4 (L535)	55		09.94	12.95	03.0520-2020.3	692020			20,64/180x42 TopKit BDX
	1.4 (L53G)			05.92	12.95	03.0520-2920.3	692920			20,64/180x41 TopKit LUC
	1.8	65		05.92	12.95					
	1.8 (L53V/453A/F)	66		09.94	12.95					
	1.9 D (L53I)	47		05.92	12.95					
	1.9 dT	66		04.91	04.92					
	1.4	43		05.89	12.95	03.0520-2920.3	692920			20,64/180x41 TopKit LUC
	1.4 (L537/53H)			05.89	12.95					
	1.4 (L53A)			09.90	12.95					
	1.7	54		05.89	12.95					
1.7 (L53C)	66		05.89	12.95						
1.9 D (L534/J)	47		05.89	12.95						
	1.7 (L53F)	79		09.90	12.95	03.0520-1919.3	691919			19,05/203x39 TopKit BDX
	1.8	79		05.92	12.95					
	1.8 (453C/D/H)	66		09.94	12.95					
	1.9 D (L53Z)	47		05.92	12.95					
	1.9 dT	66		05.92	12.95					
	1.2	40		06.89	12.92	24.3727-1012.2	581012	2	↓	L=1564
	1.4			05.89	12.95					
	1.4	43		05.89	12.95					
	1.4	55		09.94	12.95					
	1.7	54		05.89	12.95					
1.7 (L53C)	66		05.89	12.95						
1.8	65		05.92	12.95						
1.8 (L53V/453A/F)	66		09.94	12.95						
1.9 D (L534/I/J)	47		05.89	12.95						
1.9 dT	66		04.91	12.95						
	1.4	55		09.90	12.95	24.3727-1011.2	581011	2	↓	L=1564
	1.7	54		05.89	12.95					
	1.7 (L53C/F)			05.89	12.95					
	1.8	65		05.92	12.95					
	1.8	79		05.92	12.95					
	1.8 (L538)	81		05.92	12.95					
	1.8 (L53V/453A/C-F)	66		09.94	12.95					
	1.8 16V	99		05.89	12.95					
	1.9 D	47		05.89	12.95					
	1.9 dT	66		04.91	12.95					
1.9 TD (L53K)	68		09.90	04.92						
	1.7 (L53F)	79		12.94	12.95	24.6583-1710.3	320166			BRL (4)
	1.8 (453C/D/H)	66		12.94	12.95					
	1.8 (L538)	81		12.94	12.95					
	1.9 D (L53Z)	47		09.94	12.95					
	1.9 dT	66		12.94	12.95					
	1.9 dT (L53T)	66		12.94	12.95					
	1.2	40		06.89	12.92	24.3728-1005.2	591005			L=1010
	1.4			05.89	12.95					
	1.4	43		05.89	12.95					
	1.4	55		05.89	12.95					
	1.7	54		05.89	12.95					
	1.7	66		05.89	12.95					
	1.8	65		05.92	12.95					
	1.8	66		09.94	12.95					
	1.8	79		05.92	12.95					
	1.8 (L538)	81		05.92	12.95					
	1.8 16V	99		05.89	12.95					
	1.9 D	47		05.89	12.95					
	1.9 dT	66		04.91	12.95					
	1.9 TD (L53K)	68		09.90	04.92					

RENAULT R19 Cabriolet (D53_) (91-96)											
	1.7			02.91	01.92	- ABS	03.2119-3389.3	010057		Thz 19,05	ATE
	1.7			02.92	08.96	- ABS	03.2120-2031.3	010106		Thz 20,64	ATE
	1.8	65		04.92	12.94						
	1.8	66		01.93	12.94						
	1.8	79		01.93	08.96	- ABS					
	1.8 16V			02.91	03.95	- ABS					
	1.7			02.91	08.96	+ ABS/ + Schaltgetriebe ¹⁾	24.2120-1725.3	010579		Thz 20,64	BDX
	1.8 (853A)	66		01.93	08.96	+ ABS/ + Schaltgetriebe ¹⁾					
	1.8 16V			02.91	03.95	+ ABS					
	1.7			02.91	08.96		24.3481-1615.5	240031		D=48, - Halter	LUC
	1.8	65		04.92	12.94		24.3481-1616.5	240032		D=48, - Halter	LUC
	1.8	66		01.93	12.94		24.0101-4806.2	260052		Bremssattel-Zubehör	LUC
	1.8	79		09.94	08.96						
	1.8 16V			02.91	03.95						
	1.7			02.91	08.96		13.0460-2834.2	602834		21463 18,0 /WK/S	LUC
	1.8	65		04.92	12.94						
	1.8	66		01.93	12.94						
	1.8	79		09.94	08.96						
	1.8 16V			02.91	03.95						
	1.7			02.91	08.96	- ABS/ + Automatikgetriebe ²⁾	24.0120-0125.1	420125		238 20,1 17,7 V +S +B	
	1.7			02.91	12.94	+ ABS/ + Automatikgetriebe ³⁾					
	1.7			02.91	08.96	+ Schaltgetriebe ⁴⁾					
	1.8	65		04.92	12.94	- ABS/ + Automatikgetriebe ²⁾					
	1.8	65		04.92	12.94	+ ABS/ + Automatikgetriebe ³⁾					
	1.8	65		04.92	12.94	+ Schaltgetriebe ⁴⁾					
	1.8 (853A)	66		01.93	08.96	- ABS					
	1.7			01.95	08.96	+ ABS/ + Automatikgetriebe ³⁾	24.0121-0106.1	421106		259 20,6 17,7 V +S +B	
	1.8	66		01.93	08.96	+ ABS					
	1.8	79		09.94	08.96						
	1.8 16V			02.91	03.95						
	1.7			02.91	08.96		24.5111-0280.3	330389	2	L=280	
	1.8	65		04.92	12.94						
	1.8	66		01.93	08.96						
	1.8	79		09.94	08.96						
	1.8 16V			02.91	03.95						
	1.7			02.91	08.96	+ ABS	13.0460-3822.2	603822		21597 11,0 +/S	BDX
	1.8	65		04.92	12.95	+ ABS					
	1.8	66		01.93	08.96	+ ABS					
	1.8 (853F)	79		09.94	08.96	+ ABS					
	1.8 16V			02.91	03.95						
	1.7			02.91	08.96	+ ABS	24.0108-0108.1	408108		ohne Sensorring ⁵⁾	238 8,0 7,0 +B
	1.8	65		04.92	12.94	+ ABS					
	1.8	66		01.93	08.96	+ ABS					
	1.8 (853F)	79		09.94	08.96	+ ABS					
	1.8 16V			02.91	03.95						
	1.7			02.91	08.96	- ABS	24.5229-0255.3	330581	2	L=255	
	1.8	65		04.92	12.94	- ABS					
	1.8	66		01.93	08.96	- ABS					
	1.8	79		09.94	08.96	- ABS					
	1.8 16V			02.91	03.95	- ABS					
	1.7			02.91	08.96	+ ABS	24.5229-0220.3	330399	2	L=220	
	1.8	65		04.92	12.94	+ ABS					
	1.8	66		01.93	08.96	+ ABS					
	1.8	79		09.94	08.96	+ ABS					
	1.8 16V			02.91	03.95	+ ABS					
	1.7			02.91	08.96	- ABS	24.3220-1617.3	020244		RzR 20,64	BDX
	1.8	65		04.92	12.94	- ABS	24.3220-1618.3	020245		RzR 20,64	BDX
	1.8	66		01.93	08.96	- ABS	24.3220-1615.3	020242		RzR 20,64	LUC
	1.8						24.3220-1616.3	020243		RzR 20,64	LUC
	1.7			02.91	08.96	- ABS	03.0137-0209.2	650209		180 x 42	BDX
	1.8	65		04.92	12.94	- ABS	03.0137-9086.2	669086		Bremsbacken-Zubehör	BDX
	1.8	66		01.93	08.96	- ABS	03.0137-0201.2	650201		180 x 41 HEB	LUC
	1.8						03.0137-9056.2	669056		Bremsbacken-Zubehör	LUC
	1.8	79		09.94	08.96	- ABS	03.0137-0211.2	650211		203 x 39	BDX
	1.8						03.0137-9125.2	669125		Bremsbacken-Zubehör	BDX
	1.7			02.91	08.96	- ABS	24.0218-0032.1	480118		180/181 x 53,5 - Lager	
	1.8	65		04.92	12.94	- ABS	24.0218-0732.2	480207		180/181 x 53,2 + Lager	
	1.8	66		01.93	08.96	- ABS					
	1.8	79		09.94	08.96	- ABS	24.0220-3021.1	480127		203/204,5 x 50,5 - Lager	
	1.7			02.91	08.96	- ABS	03.0520-2020.3	692020		20,64/180x42 TopKit	BDX
	1.8	65		04.92	12.94	- ABS	03.0520-2920.3	692920		20,64/180x41 TopKit	LUC
	1.8	66		01.93	08.96	- ABS					
	1.8	79		09.94	08.96	- ABS	03.0520-1919.3	691919		19,05/203x39 TopKit	BDX
	1.7			02.91	08.96	- ABS	24.3727-1012.2	581012	2	L=1564	
	1.8	65		04.92	12.94	- ABS					
	1.8	66		01.93	08.96	- ABS					
	1.7			02.91	08.96	+ ABS	24.3727-1011.2	581011	2	L=1564	
	1.8	65		04.92	12.94	+ ABS					
	1.8	66		01.93	08.96	+ ABS					
	1.8 16V	79		09.94	08.96						
1.8 16V			02.91	03.95							

1) + ABS/ + manual transm. / + ABS/+ scatola camb.velocità / + ABS/ + transmission mécanique / + ABS/ + cambio de velocidad
2) - ABS/ + autom.transmission / - ABS/ + scatola cambio autom. / - ABS/ + transmission automatique / - ABS/ + cambio automático
3) + ABS/ + autom.transmission / + ABS/ + scatola cambio autom. / + ABS/ + transmission automatique / + ABS/ + cambio automático
4) + manual transmission / + scatola cambio velocità / + transmission mécanique / + cambio de velocidad
5) without sensor ring / senza sensori / sans secours ABS / sin anillo sensor ABS













RENAULT R19 Cabriolet (D53_) (91-96)								
	1.7		02.91	08.96	24.3728-1005.2	591005		L=1010
	1.8	65	04.92	12.94				
	1.8	66	01.93	08.96				
	1.8	79	09.94	08.96				
	1.8 16V		02.91	03.95				
RENAULT R20 (76-84)								
	2.0 (R1272)		01.78	12.84 + (S)	24.2120-1709.3	010276		Thz 20,64
	2.0 (R1277)		01.81	12.84 + (D)				
	2.1 (R1276)		01.80	12.84				
	2.0 (R1277)		01.81	12.84 + (D)	24.3541-1625.5	240045		D=54, - Halter LUC
	2.1 (R1276)		01.80	12.84	24.3541-1626.5	240046		D=54, - Halter LUC
	1.6 (R1271)		01.76	05.80	13.0460-3928.2	603928		20140 14,0 +/-WE BDX
	1.6 (R1271)		06.80	12.81	13.0460-3911.2	603911		20905 18,0 +/-WK BDX
					13.0460-0411.2	610411		Belagsatz-Zubehör BDX
	2.0 (R1272)		01.78	12.80	13.0460-3968.2	603968		20488 18,5 +/-WK BDX
	2.0 (R1272)		01.81	12.84 - (S)				
	2.0 (R1277)		01.81	12.84 - (D)				
	2.2 (R1279)		01.81	12.84				
	2.0 (R1272)		01.81	12.84 + (S)	13.0460-3911.2	603911		20905 18,0 +/-WK BDX
	2.0 (R1277)		01.81	12.84 + (D)	13.0460-2834.2	602834		21463 18,0 /WK/S LUC
	2.1 (R1276)		01.80	12.84	13.0460-0411.2	610411		Belagsatz-Zubehör BDX
	2.0 (R1272)		01.78	12.80	24.0124-0103.1	424103		253 24,0 22,0 V +B
	2.0 (R1272)		01.81	12.84 - (S)				
	2.0 (R1277)		01.81	12.84 - (D)				
	2.2 (R1279)		01.81	12.84				
	1.6 (R1271)		01.81	12.81	24.5112-0385.3	330392	2	L=385
	2.0 (R1272)		01.81	12.84 - (MS)				
	2.0 (R1277)		01.81	12.84				
	2.1 (R1276)		01.80	12.84				
	2.2 (R1279)		01.81	12.84				
	1.6 (R1271)		01.76	12.81	24.3222-1108.3	020263		Rz 22,20 BDX
	2.0 (R1272)		01.78	12.84	24.3222-1109.3	020264		Rz 22,20 BDX
	2.0 (R1277)		01.81	12.84	24.3222-1609.3	020279		Rz 22,20 LUC
	2.1 (R1276)		01.80	12.84				
	1.6 (R1271)		01.76	12.81	03.0137-0139.2	650139		229 x 42 BDX
	2.0 (R1272)		01.78	12.84	03.0137-0124.2	650124		229 x 42 HEB AUT BDX
	2.0 (R1277)		01.81	12.84	03.0137-0271.2	650271		229 x 42 HEB LUC
	2.1 (R1276)		01.80	12.84	03.0137-9020.2	669020		Bremsbacken-Zubehör BDX
	1.6 (R1271)		01.76	12.81	03.0520-0522.3	690522		22,20/229x42 TopKit BDX
	2.0 (R1272)		01.78	12.84				
	2.0 (R1277)		01.81	12.84				
	2.1 (R1276)		01.80	12.84				
	2.0 (R1272)		01.78	12.84	24.2528-0908.3	040065		Nz 28,57
	2.0 (R1277)		01.81	12.84				
	2.2 (R1279)		01.81	12.84				
RENAULT R21 Limousine (B48/L48_) (86-93)								
	1.4 (B/L 48D)	51	06.88	12.92	03.2119-3389.3	010057		Thz 19,05 ATE
	1.6 (L 48U)		06.88	08.90 - (MA)				
	1.7 (B 482)	65	09.89	05.92 - (MA)				
	1.7 (B/L 481)	55	01.86	05.92				
	1.7 (B/L 484)		06.90	05.92				
	1.7 (B/L 48J)		01.87	05.91				
	1.7 (L 482)	65	01.86	05.92 - (E) (MA)				
	1.7 (L 48M)	54	10.87	05.92				
	1.7 (L 48N)	64	10.87	05.92				
	1.7 i (B 48F)	54	08.86	05.92				
	1.7 i (B/L 48E)	66	08.86	05.92				
	1.9 D (B/L 48H)	47	05.89	12.92				
	1.9 D (B/L 48I)	47	04.92	12.93				
	2.2 i (L 48S)	79	06.88	04.89				
	1.6 (B 48U)		06.90	03.92	03.2120-2682.3	010118		Thz 20,64 ATE
	1.6 (L 48U)		01.91	12.93 - (MA)				
	1.7 (B 482)	65	09.89	05.92 + (MA)				
	1.7 (B 482)	65	06.92	12.92 - (MA)				
	1.7 (B/L 481)	55	06.92	12.92				
	1.7 (B/L 484)		06.92	12.93				
	1.7 (L 482)	65	01.86	05.92 + (E)				
	1.7 (L 482)	65	06.92	12.92 - (E)				
	1.7 i (B 48E)	66	06.92	12.93				
	1.7 i (B 48F)	54	06.92	12.93				
	1.7 i (L 48E)	66	06.92	12.93 + (F)				
	2.0 (L 489)		01.87	04.89				
	2.0 (L 489)		01.87	03.93				
	2.0 i (B 483)		01.86	12.92 - ABS				
	2.0 i (B 48R)	99	09.89	12.93 - ABS				
	2.0 i (B 48Y)	99	09.89	03.92				
	2.0 i (B/L 48C)	88	06.90	12.93 - ABS				
	2.1 D (B 48V)	53	09.89	12.93				
	2.1 TD (B 486)	65	09.89	12.92				
	2.1 TD (B 48W)	65	09.89	05.91				
	2.1 TD (L 486)	65	01.86	04.89				
	2.1 TD (L 486)	65	01.86	10.92				



RENAULT R21 Limousine (B48/L48_) (86-93)









	2.2 i (B 48K) ▶ 79	06.90	10.92	- ABS	03.2120-2682.3	010118		Thz 20,64	ATE
	2.2 i (L 48K) ◀ 79	08.86	04.89	- ABS					
	2.2 i (L 48K) ▶ 79	08.86	12.93	- ABS					
	1.6 (L 48U)	06.88	12.93	+ MA	03.2122-9631.3	010160		Thz 22,20	ATE
	1.7 (L 482) 65	09.90	12.92	+ E MA					
	2.0 (L 489) ◀	05.89	03.93						
	2.0 i (B 483) ◀	09.89	12.92	- ABS/ - MA					
	2.0 i (B 483) ◀	09.90	12.92	- ABS/ + MA					
	2.0 i (B 48R) ◀ 99	09.89	12.93	- ABS					
	2.0 i (B 48Y) ◀ 99	09.89	03.92	- ABS					
	2.0 i (B/L 48C) ◀ 88	06.90	12.93	- ABS					
	2.0 i (L 483)	05.89	12.92	- ABS					
	2.0 i (L 48Q)	05.89	03.92	- ABS					
	2.0 i (L 48R)	05.89	12.93						
	2.0 i (L 48Y)	05.89	03.92	- ABS					
	2.1 D (B 480)	04.92	12.92	- ABS					
	2.1 D (B 48V) ◀ 53	09.89	12.93						
	2.1 D (B/L 480)	04.92	12.93	- ABS					
	2.1 D (L 480)	04.92	12.93						
	2.1 D (L 48V)	05.89	12.93						
	2.1 TD (B 487)	06.91	12.93	- ABS					
	2.1 TD (B 488)	09.89	10.92	- ABS/ - MA					
	2.1 TD (B 488)	09.90	10.92	- ABS/ + MA					
	2.1 TD (B 48A)	04.92	12.93						
	2.1 TD (B/L 486)	05.89	12.92						
	2.1 TD (B/L 48W)	05.89	05.91						
	2.1 TD (L 487)	07.91	12.93						
	2.1 TD (L 488)	05.89	10.92	- ABS					
	2.1 TD (L 48A)	04.92	12.93	- ABS					
	2.2 i (B 48K)	09.89	10.92	- ABS					
	2.2 i (L 48K) ◀ 79	05.89	12.93	- ABS					
	2.2 i (L 48S)	05.89	12.93						
	1.4 (B/L 48D)	06.88	12.92		24.3481-1611.5	240029	☐	D=48, - Halter	LUC
	1.7 (B/L 481)	01.86	12.92		24.3481-1612.5	240030	☐	D=48, - Halter	LUC
					24.0101-4807.2	260053		Bremssattel-Zubehör	LUC
	1.7 (L 48M)	10.87	05.90		24.3481-1615.5	240031	☐	D=48, - Halter	LUC
	1.7 i (B 48F)	08.86	12.93		24.3481-1616.5	240032	☐	D=48, - Halter	LUC
	1.6 (L 48U)	06.88	12.93		24.3481-1615.5	240031	☐	D=48, - Halter	LUC
	1.7 (B 482)	09.89	12.92	- MA	24.3481-1616.5	240032	☐	D=48, - Halter	LUC
	1.7 (B/L 484)	06.90	12.93		24.0101-4806.2	260052		Bremssattel-Zubehör	LUC
	1.7 (B/L 48J)	01.87	05.91						
	1.7 (L 482)	01.86	12.92	- E MA					
	1.7 (L 48N)	10.87	05.90						
	1.7 i (B/L 48E)	08.86	12.93						
	1.9 D (B/L 48H)	05.89	12.92						
	1.9 D (B/L 48I)	04.92	12.93						
	1.6 (L 48U)	06.90	03.92		24.3541-1625.5	240045	☐	D=54, - Halter	LUC
	1.7 (B 482)	09.89	12.92	+ MA	24.3541-1626.5	240046	☐	D=54, - Halter	LUC
	1.7 (L 482)	01.86	12.92	+ E MA					
	1.4 (B/L 48D)	06.88	12.92		13.0460-3911.2	603911		20905 18,0 +WK	BDX
	1.7 (B/L 481)	01.86	12.92		13.0460-2834.2	602834		21463 18,0 /WK/S	LUC
	1.7 (L 48M)	10.87	05.90		13.0460-0411.2	610411		Belagsatz-Zubehör	BDX
	1.7 i (B 48F)	08.86	12.93						
	1.6 (B/L 48U)	06.88	12.93		13.0460-2834.2	602834		21463 18,0 /WK/S	LUC
	1.7 (B/L 482)	01.86	12.92						
	1.7 (B/L 484)	06.90	12.93						
	1.7 (B/L 48J)	01.87	05.91						
	1.7 (L 48N)	10.87	05.90						
	1.7 i (B/L 48E)	08.86	12.93						
	1.9 D (B/L 48H)	05.89	12.92						
	1.9 D (B/L 48I)	04.92	12.93						
	2.0 (L 489)	01.87	03.93		13.0460-3933.2	603933		21016 17,0 +WK	BDX
	2.0 i (B/L 483)	01.86	12.92						
	2.0 i (B/L 48C)	06.90	12.93						
	2.0 i (B/L 48R)	05.89	12.93						
	2.0 i (B/L 48Y)	05.89	03.92						
	2.0 i (L 48Q)	05.89	03.92						
	2.0 T (L 485)	06.87	03.92						
	2.0 T (L 48L)	05.89	12.93						
	2.1 D (B/L 480)	04.92	12.93						
	2.1 D (B/L 480)	04.92	12.93						
	2.1 D (B/L 48V)	05.89	12.93						
	2.1 TD (B/L 486)	01.86	12.92						
	2.1 TD (B/L 487)	06.91	12.93						
	2.1 TD (B/L 488)	01.86	10.92						
	2.1 TD (B/L 48A)	04.92	12.93						
	2.1 TD (B/L 48W)	05.89	05.91						
	2.2 i (B/L 48K)	08.86	12.93						
	2.2 i (L 48S)	06.88	12.93						
	1.4 (B/L 48D)	06.88	12.92		24.0112-0116.1	412116		238 12,0 10,5 +S +B	
	1.7 (B/L 481)	01.86	12.92						
	1.6 (B/L 48U)	06.88	12.93		24.0120-0125.1	420125		238 20,1 17,7 V +S +B	
	1.7 (B/L 482)	01.86	12.92						
	1.7 (B/L 484)	06.90	12.93						
	1.7 (B/L 48J)	01.87	05.91						
	1.7 (L 48M)	10.87	05.90						



									
RENAULT R21 Limousine (B48/L48_) (86-93)									
	1.7 (L 48N)	64		10.87	05.90	24.0120-0125.1	420125		238 20,1 17,7 V +S +B
	1.7 i (B 48F)	54		08.86	12.93				
	1.7 i (B/L 48E)	66		08.86	12.93				
	1.9 D (B/L 48H)	47		05.89	12.92				
	1.9 D (B/L 48I)	47		04.92	12.93				
	2.0 (L 489)			01.87	03.93	24.0120-0134.1	420134		265 20,5 17,7 V
	2.0 i (B/L 483)			01.86	12.92				
	2.0 i (B/L 48C)	88		06.90	12.93				
	2.2 i (B/L 48K)	79		08.86	12.93				
	2.2 i (L 48S)	79		06.88	12.93				
	2.0 i (B/L 48R)	99		05.89	12.93	24.0121-0103.1	421103		285 21,0 19,0 V
	2.0 i (B/L 48Y)	99		05.89	03.92				
	2.0 i (L 48Q)			05.89	03.92				
	2.0 T (L 485)			06.87	03.92	24.0121-0101.1	421101		285 21,0 19,0 V
	2.0 T (L 48L)			05.89	12.93				
	2.1 D (B 480)	53		04.92	12.93	24.0120-0135.1	420135		244 20,5 17,7 V
	2.1 D (B 48V)	53		09.89	12.93				
	2.1 D (B/L 480)	51		04.92	12.93				
	2.1 TD (B 486)	65		09.89	12.92				
	2.1 TD (B/L 487)	65		06.91	12.93				
2.1 TD (B/L 48W)	65		05.89	05.91					
2.1 TD (L 48A)	65		04.92	12.93					
2.1 TD (L 48P)	65		07.91	03.92					
2.1 D (L 480)	53		04.92	12.93	24.0120-0135.1	420135		244 20,5 17,7 V	
2.1 D (L 48V)	53		05.89	12.93					
2.1 TD (B 488)	65		09.89	10.92					
2.1 TD (B 48A)	65		04.92	12.92					
2.1 TD (L 486)	65		01.86	10.92					
2.1 TD (L 488)	65		01.86	10.92					
2.1 D (L 480)	53		04.92	12.93	24.0120-0134.1	420134		265 20,5 17,7 V	
2.1 D (L 48V)	53		05.89	12.93					
2.1 TD (B 488)	65		09.89	10.92					
2.1 TD (B 48A)	65		04.92	12.92					
2.1 TD (L 486)	65		01.86	10.92					
2.1 TD (L 488)	65		01.86	10.92					
	1.4 (B/L 48D)	51		06.88	12.92	24.5111-0241.3	330680	2	L=242
	1.6 (L 48U)			06.88	12.93				
	1.7 (B 482)	65		09.89	12.92				
	1.7 (B/L 481)	55		01.86	12.92				
	1.7 (B/L 484)			06.90	12.93				
	1.7 (B/L 48J)			01.87	05.91				
	1.7 (L 482)	65		01.86	12.92				
	1.7 (L 48M)	54		10.87	05.92				
	1.7 (L 48N)	64		10.87	05.92				
	1.7 i (B 48F)	54		08.86	12.93				
	1.7 i (L 48E)	66		08.86	12.93				
	1.9 D (B/L 48H)	47		05.89	12.92				
	1.9 D (B/L 48I)	47		04.92	12.93				
	2.0 (L 489)			01.87	03.93	24.5111-0320.3	330487	2	L=320
	2.0 i (B/L 483)			01.86	12.92				
	2.0 i (B/L 48C)	88		06.90	12.93				
	2.0 i (B/L 48R)	99		05.89	12.93				
	2.0 i (B/L 48Y)	99		05.89	03.92				
	2.0 i (L 48Q)			05.89	03.92				
	2.1 D (B/L 480)	51		04.92	12.93				
2.1 D (B/L 480)	53		04.92	12.93					
2.1 D (B/L 48V)	53		05.89	12.93					
2.1 TD (B/L 486)	65		01.86	12.92					
2.1 TD (B/L 487)	65		06.91	12.93					
2.1 TD (B/L 488)	65		01.86	10.92					
2.1 TD (B/L 48A)	65		04.92	12.93					
2.1 TD (B/L 48P)	65		06.91	03.92					
2.1 TD (B/L 48W)	65		05.89	05.91					
2.2 i (B/L 48K)	79		08.86	12.93					
2.2 i (L 48S)	79		06.88	12.93					
2.0 i (B/L 483)			01.86	12.92	24.5111-0320.3	330487	2	L=320	
2.0 i (B/L 48C)	88		06.90	12.93					
2.0 i (B/L 48R)	99		05.89	12.93					
2.0 i (B/L 48Y)	99		05.89	03.92					
2.0 i (L 48Q)			05.89	03.92					
2.1 D (B/L 480)	51		04.92	12.93					
2.1 D (B/L 480)	53		04.92	12.93					
2.1 TD (B/L 488)	65		01.86	10.92					
2.1 TD (B/L 48A)	65		04.92	12.93					
2.2 i (B/L 48K)	79		08.86	12.93					
	2.0 i (B/L 483)			03.87	12.92	24.0711-1403.3	360100		Radsensor L=1289
	2.0 i (B/L 48C)	88		06.90	12.93				
	2.0 i (B/L 48R)	99		05.89	12.93				
	2.0 i (B/L 48Y)	99		05.89	03.92				
	2.0 i (L 48Q)			05.89	03.92				
	2.0 T (L 485)			06.87	03.92				
	2.0 T (L 48L)			05.89	12.93				
	2.1 D (B/L 480)	51		04.92	12.93				
	2.1 TD (B 487)	65		06.91	12.93				
	2.1 TD (B/L 488)	65		03.87	12.92				
2.1 TD (B/L 48A)	65		04.92	12.93					

RENAULT R21 Limousine (B48/L48_) (86-93)											
	2.2 i (B/L 48K)	79		03.87	12.93		24.0711-1403.3	360100			Radsensor L=1289
	2.0 i (B/L 483)			03.87	12.92 + ABS		13.0460-3961.2	603961			20336 14,0 +/WK BDX
	2.0 i (B/L 48C)	88		06.90	12.93 + ABS		13.0460-4957.2	604957			20410 15,0 + BRE
	2.0 i (B/L 48R)	99		05.89	12.93		13.0460-0438.2	610438			Belagsatz-Zubehör BRE
	2.0 i (B/L 48Y)	99		05.89	03.92						
	2.0 i (L 48Q)			05.89	03.92						
	2.0 T (L 485)			06.87	03.92						
	2.0 T (L 48L)			05.89	12.93						
	2.1 D (B 480)	53		04.92	12.92 + ABS						
	2.1 D (B/L 480)	51		04.92	12.93 + ABS						
	2.1 TD (B 487)	65		06.91	12.93 + ABS						
	2.1 TD (B/L 488)	65		03.87	10.92 + ABS						
	2.1 TD (B/L 48A)	65		04.92	12.93 + ABS						
	2.1 TD (L 48P)	65		07.91	03.92 + ABS						
	2.2 i (B/L 48K)	79		03.87	12.93 + ABS						
	2.0 i (B/L 483)			03.87	12.92 + ABS		24.0111-0122.1	411122			255 10,5 9,5
	2.0 i (B/L 48C)	88		06.90	12.93 + ABS						
	2.0 i (B/L 48R)	99		05.89	12.93						
	2.0 i (B/L 48Y)	99		05.89	03.92						
	2.0 i (L 48Q)			05.89	03.92						
	2.1 D (B 480)	53		04.92	12.92 + ABS						
	2.1 D (B/L 480)	51		04.92	12.93 + ABS						
	2.1 TD (B 487)	65		06.91	12.93 + ABS						
	2.1 TD (B/L 488)	65		03.87	10.92 + ABS						
	2.1 TD (B/L 48A)	65		04.92	12.93 + ABS						
	2.1 TD (L 48P)	65		07.91	03.92 + ABS						
	2.2 i (B/L 48K)	79		03.87	12.93 + ABS						
	2.0 i (B/L 483)			01.86	12.92 - ABS		24.5229-0220.3	330399	2		L=220
	2.0 i (B/L 48C)	88		06.90	12.93 - ABS						
	2.0 i (B/L 48R)	99		05.89	12.93 - ABS						
	2.0 i (B/L 48Y)	99		05.89	03.92 - ABS						
	2.0 i (L 48Q)			05.89	03.92 - ABS						
	2.1 D (B/L 480)	51		04.92	12.93 - ABS						
	2.1 D (B/L 480)	53		04.92	12.93 - ABS						
	2.1 TD (B/L 488)	65		01.86	10.92 - ABS						
	2.1 TD (B/L 48A)	65		04.92	12.93 - ABS						
	2.2 i (B/L 48K)	79		08.86	12.93 - ABS						
	2.0 i (B/L 483)			01.86	12.92 + ABS		24.5229-0220.3	330399	2	Länge beachten ¹⁾	L=220
	2.0 i (B/L 48C)	88		06.90	12.93 + ABS		24.5111-0320.3	330487	2	Länge beachten ¹⁾	L=320
	2.0 i (B/L 48R)	99		05.89	12.93 + ABS		24.5111-0260.3	330408	2	Länge beachten ¹⁾	L=260
	2.0 i (B/L 48Y)	99		05.89	03.92 + ABS		24.5229-0285.3	330032	2	Länge beachten ¹⁾	L=285
	2.0 i (L 48Q)			05.89	03.92 + ABS						
	2.0 T (L 485)			06.87	03.92 + ABS						
	2.1 D (B/L 480)	51		04.92	12.93 + ABS						
	2.1 D (B/L 480)	53		04.92	12.93 + ABS						
	2.1 TD (B/L 488)	65		01.86	10.92 + ABS						
	2.1 TD (B/L 48A)	65		04.92	12.93 + ABS						
	2.2 i (B/L 48K)	79		08.86	12.93 + ABS						
	1.6 (B 48U)			06.90	03.92		24.3222-1709.3	020111			Rz 22,20 BDX
	1.7 (B 482)	65		09.89	12.92 +		24.3222-1710.3	020112			Rz 22,20 BDX
	1.7 (L 481)	55	S0001313	01.86							
	1.7 (L 481)	55	H0009140	01.86							
	1.7 (L 481)	55	D0003266	01.86							
	1.7 (L 482)	65	U0034082	01.86							
	1.7 (L 482)	65	S0070467	01.86							
	1.7 (L 482)	65	H0043418	01.86							
	1.7 (L 482)	65	D0024931	01.86							
	1.7 (L 48J)		S0000116	01.87							
	1.7 i (L 48E)	66	H0003449	08.86							
	2.1 TD (L 486)	65	U0020806	01.86	- (E)						
	2.1 TD (L 486)	65	S0005652	01.86	- (E)						
	2.1 TD (L 486)	65	H0007702	01.86	- (E)						
	2.1 TD (L 486)	65		01.86	10.92 + (E)						
	1.4 (B 48D)	51	S0006089	09.89			24.3222-1618.3	020325			Rz 22,20
	1.4 (L 48D)	51	S0002915	06.88			24.3222-1617.3	020324			Rz 22,20
	1.4 (L 48D)	51	H0012053	06.88							
	1.7 (B 481)	55	S0007101	09.89							
	1.7 (B 482)	65	S0060304	09.89	-						
	1.7 (B 484)		S0000049	06.90							
	1.7 (B 48J)			09.89	05.91						
	1.7 (L 481)	55	S0001314	S0025346							
	1.7 (L 481)	55	H0009141	H0011287							
	1.7 (L 481)	55	D0003267	D0006514							
	1.7 (L 482)	65	U0034083	U0090483							
	1.7 (L 482)	65	S0070468	S0223510							
	1.7 (L 482)	65	H0043419	H0082328							
	1.7 (L 482)	65	E0070609	01.86							
	1.7 (L 482)	65	D0024932	D0037794							
	1.7 (L 484)		S0000019	06.90							
	1.7 (L 48J)		S0003038								
	1.7 (L 48M)	54		10.87	05.90						
	1.7 (L 48N)	64		10.87	05.90						
	1.7 i (B 48E)	66	S0008733	09.89							
	1.7 i (B 48F)	54	S0036357	09.89							

¹⁾ notice length / attenzione lunghezza / faire attention longueur / atención largo

RENAULT R21 Limousine (B48/L48_) (86-93)													
	1.7 i (L 48E) 1.7 i (L 48E) 1.9 D (B 48H) 1.9 D (L 48H) 1.9 D (L 48H) 1.9 D (L 48I) 2.1 D (B 48V) 2.1 D (B 48V) 2.1 D (L 48V) 2.1 D (L 48V) 2.1 TD (B 486) 2.1 TD (L 486) 2.1 TD (L 486)	66 66 47 47 47 47 53 53 53 53 65 65 65	H0003450 H0011574 S0005583 S0002098 H0001369 S0060120 E0006146 S0022488 H0011781 S0005100 U0020807 S0005653 H0007703	S0005972 H0011574 S0005583 S0002098 H0001369 S0060120 E0006146 S0022488 H0011781 S0005100 U0074005 S0040195 H0017034	08.86 09.89 05.89 05.89 04.92 12.92 09.89 09.89 05.89 05.89 09.89 09.89	24.3222-1618.3 24.3222-1617.3	020325 020324	 			Rz 22,20 Rz 22,20		
	1.4 (B 48D) 1.4 (L 48D) 1.4 (L 48D) 1.6 (L 48U) 1.7 (B 481) 1.7 (B 482) 1.7 (B 484) 1.7 (L 481) 1.7 (L 481) 1.7 (L 481) 1.7 (L 482) 1.7 (L 482) 1.7 (L 482) 1.7 (L 482) 1.7 (L 482) 1.7 (L 482) 1.7 (L 484) 1.7 (L 48J) 1.7 i (B 48E) 1.7 i (L 48E) 1.7 i (L 48E) 1.9 D (B 48H) 1.9 D (B/L 48I) 1.9 D (B/L 48I) 1.9 D (L 48H) 2.1 D (B 480) 2.1 D (B 48V) 2.1 D (B 48V) 2.1 D (B/L 480) 2.1 D (L 480) 2.1 D (L 48V) 2.1 D (L 48V) 2.1 TD (B 486) 2.1 TD (L 486) 2.1 TD (L 486)	51 51 51 55 65 S0000050 55 55 55 65 65 65 65 65 65 65 S0000020 S0003039 66 66 66 47 47 47 47 53 53 53 51 53 53 65 65 65	S0006090 H0012054 S0002916 S0007102 S0060305 S0000050 D0006515 H0011288 S0025347 D0037795 E0070610 H0082329 S0223511 U0090484 S0000020 S0003039 S0008734 H0011575 S0005973 S0005584 S0002099 H0001370 S0006147 S0060121 S0022489 H0011782 S0022489 S0005101 H0017035 S0040196 U0074006	S0006090 H0012054 S0002916 S0007102 S0060305 S0000050 D0006515 H0011288 S0025347 D0037795 E0070610 H0082329 S0223511 U0090484 S0000020 S0003039 S0008734 H0011575 S0005973 S0005584 S0002099 H0001370 S0006147 S0060121 S0022489 H0011782 S0022489 S0005101 H0017035 S0040196 U0074006	10.92 12.92 12.92 06.88 12.93 + (MA) 12.92 12.92 - (MA) 03.93 12.92 12.92 12.92 12.92 12.92 12.92 12.92 12.92 12.93 02.91 12.93 12.93 12.93 12.92 04.92 12.93 10.92 10.92 04.92 12.92 - ABS 12.93 12.93 04.92 12.93 - ABS 12.93 12.93 12.92 10.92 - (E) 10.92 - (E) 10.92 - (E)	24.3222-1617.3 24.3222-1618.3	020324 020325	 			Rz 22,20 Rz 22,20		
	1.6 (L 48U) 2.0 (L 489) 2.0 i (B/L 483) 2.0 i (B/L 48C) 2.1 TD (B 487) 2.1 TD (B/L 488) 2.1 TD (B/L 48A) 2.1 TD (B/L 48W) 2.1 TD (L 487) 2.1 TD (L 48P) 2.2 i (B/L 48K) 2.2 i (L 48S)	88 65 65 65 65 65 65 65 79 79	S0000050 S0000050 S0000050 S0000050 S0000050 S0000050 S0000050 S0000050 S0000050 S0000050 S0000050 S0000050	S0000050 S0000050 S0000050 S0000050 S0000050 S0000050 S0000050 S0000050 S0000050 S0000050 S0000050 S0000050	06.88 01.87 01.86 06.90 06.91 01.86 04.92 05.89 07.91 07.91 08.86 06.88	12.93 03.93 12.92 - ABS 12.93 - ABS 12.93 - ABS 10.92 - ABS 12.93 - ABS 12.93 12.93 03.92 - ABS 12.93 - ABS 12.93	24.3222-1122.3 24.3222-1123.3	020335 020336	 		Rz 22,20 Rz 22,20		
	1.4 (B/L 48D) 1.6 (B 48U) 1.6 (L 48U) 1.7 (B/L 481) 1.7 (B/L 482) 1.7 (B/L 484) 1.7 (B/L 48J) 1.7 (L 48M) 1.7 (L 48N) 1.7 i (B 48F) 1.7 i (B/L 48E) 1.9 D (B/L 48H) 1.9 D (B/L 48I) 2.1 D (B/L 480) 2.1 D (B/L 480) 2.1 D (B/L 48V) 2.1 TD (B/L 486)	51 55 65 54 64 54 66 47 47 51 53 53 65	S0000050 S0000050 S0000050 S0000050 S0000050 S0000050 S0000050 S0000050 S0000050 S0000050 S0000050 S0000050 S0000050 S0000050 S0000050 S0000050 S0000050	S0000050 S0000050 S0000050 S0000050 S0000050 S0000050 S0000050 S0000050 S0000050 S0000050 S0000050 S0000050 S0000050 S0000050 S0000050 S0000050 S0000050	06.88 06.90 06.88 01.86 01.86 06.90 01.87 10.87 10.87 08.86 08.86 05.89 04.92 04.92 04.92 05.89 01.86	12.92 03.92 12.93 + (MA) 12.92 12.92 12.93 05.91 05.90 05.90 12.93 12.93 12.92 12.93 12.93 - ABS 12.93 12.93 12.92	03.0137-0209.2 03.0137-9086.2	650209 669086			180 x 42 BDX Bremsbacken-Zubehör BDX		
	1.6 (L 48U) 1.7 (L 484) 2.0 (L 489) 2.0 i (B/L 483) 2.0 i (B/L 48C) 2.1 TD (B 487) 2.1 TD (B/L 488) 2.1 TD (B/L 48A) 2.1 TD (B/L 48W)	88 65 65 65 65 65	S0000050 S0000050 S0000050 S0000050 S0000050 S0000050 S0000050 S0000050 S0000050	S0000050 S0000050 S0000050 S0000050 S0000050 S0000050 S0000050 S0000050 S0000050	06.88 06.90 01.87 01.86 06.90 06.91 01.86 04.92 05.89	12.93 - (MA) 12.93 03.93 12.92 - ABS 12.93 - ABS 12.93 - ABS 10.92 - ABS 12.93 12.93	03.0137-0271.2 03.0137-9027.2	650271 669027			229 x 42 HEB LUC Bremsbacken-Zubehör LUC		



RENAULT R21 Limousine (B48/L48_) (86-93)

	2.1 TD (L 487) 2.2 i (B/L 48K) 2.2 i (L 48S)	65 79 79		07.91 08.86 06.88	12.93 12.93 12.93	- ABS	03.0137-0271.2 03.0137-9027.2	650271 669027		229 x 42 HEB Bremsbacken-Zubehör	LUC LUC
	1.4 (B/L 48D) 1.6 (B/L 48U) 1.7 (B/L 481) 1.7 (B/L 482) 1.7 (B/L 484) 1.7 (B/L 48J) 1.7 (L 48M) 1.7 (L 48N) 1.7 i (B 48F) 1.7 i (B/L 48E) 1.9 D (B/L 48H) 1.9 D (B/L 48I) 2.1 D (B 480) 2.1 D (B/L 480) 2.1 D (B/L 48V) 2.1 D (L 480) 2.1 TD (B/L 486)	51 51 55 65 51 54 64 54 66 47 47 53 51 53 53 65		06.88 06.88 01.86 01.86 06.90 01.87 10.87 10.87 08.86 08.86 05.89 04.92 04.92 05.89 04.92 01.86	12.92 12.93 12.92 12.92 12.93 05.91 05.90 05.90 12.93 12.93 12.92 12.93 12.93 12.93 12.93 12.92	- ABS - ABS - ABS - ABS - ABS - ABS - ABS - ABS - ABS - ABS - ABS - ABS - ABS - ABS - ABS - ABS	24.0218-0013.1	480008		180/181,3 x 53 - Lager	
	2.0 (L 489) 2.0 i (B/L 483) 2.0 i (B/L 48C) 2.1 D (B 480) 2.1 D (B/L 48V) 2.1 TD (B 487) 2.1 TD (B/L 488) 2.1 TD (B/L 48A) 2.1 TD (B/L 48W) 2.1 TD (L 487) 2.2 i (B/L 48K) 2.2 i (L 48S)	88 53 53 65 65 65 65 65 65 79 79		01.87 01.86 06.90 09.89 05.89 06.91 01.86 04.92 05.89 07.91 08.86 06.88	03.93 12.92 12.93 12.92 12.93 12.93 10.92 12.93 05.91 12.93 12.93 12.93	- ABS - ABS - ABS - ABS - ABS - ABS - ABS - ABS - ABS - ABS - ABS	24.0222-8015.1 24.0222-8019.2	480055 480087		229/229,5 x 52,5 229/229,5 x 52,5	
	1.6 (B 48U) 1.7 (B 482) 1.7 (L 481) 1.7 (L 481) 1.7 (L 481) 1.7 (L 482) 1.7 (L 482) 1.7 (L 482) 1.7 (L 482) 1.7 (L 48J) 1.7 i (L 48E) 2.1 TD (L 486) 2.1 TD (L 486) 2.1 TD (L 486) 2.1 TD (L 486)	65 55 55 55 65 65 65 65 66 65 65 65 65 65	S0001313 H0009140 D0003266 U0034082 S0070467 H0043418 D0024931 S0000116 H0003449 U0020806 S0005652 H0007702	06.90 09.89 01.86 01.86 01.86 01.86 01.86 01.86 01.87 08.86 01.86 01.86 01.86 01.86	03.92 12.92 + MA		03.0520-1022.3	691022		22,20/180x42 TopKit	BDX
	1.4 (B 48D) 1.4 (L 48D) 1.7 (B 481) 1.7 (B 482) 1.7 (B 484) 1.7 (B 48J) 1.7 (L 481) 1.7 (L 481) 1.7 (L 481) 1.7 (L 482) 1.7 (L 482) 1.7 (L 482) 1.7 (L 482) 1.7 (L 482) 1.7 (L 482) 1.7 (L 484) 1.7 (L 48J) 1.7 (L 48M) 1.7 (L 48N) 1.7 i (B 48E) 1.7 i (B 48F) 1.7 i (L 48E) 1.9 D (B 48H) 1.9 D (L 48H) 1.9 D (L 48I) 2.1 D (B 48V) 2.1 D (L 48V) 2.1 TD (B 486) 2.1 TD (L 486) 2.1 TD (L 486) 2.1 TD (L 486)	51 51 55 65 65 55 55 55 65 65 65 65 65 65 65 54 64 66 54 66 47 47 47 53 53 65 65 65 65	D0003267 H0009141 S0001314 D0024932 S0070468 H0043419 U0034083 S0000117	09.89 06.88 09.89 09.89 06.90 09.89 12.93 12.93 12.93 12.93 12.93 12.93 12.93 12.93 06.90 12.93 10.87 10.87 09.89 09.89 12.93 09.89 05.89 04.92 09.89 05.89 09.89 04.92 12.93 12.93 12.93	12.93 12.93 12.93 12.93 12.93 05.91 12.93 12.93 12.93 12.93 12.93 12.93 12.93 12.93 05.90 05.90 12.93 12.93 12.93 12.93 12.93 12.93 12.93 12.93 12.93 12.93 12.93 12.93 12.93 12.93	- MA - MA	03.0520-1222.3	691222		22,20/180x42 TopKit	BDX
	1.6 (L 48U) 2.0 (L 489) 2.0 i (B/L 483) 2.0 i (B/L 48C) 2.1 TD (B 487) 2.1 TD (B/L 488) 2.1 TD (B/L 48A) 2.1 TD (B/L 48W) 2.1 TD (L 487) 2.1 TD (L 48P) 2.2 i (B/L 48K)	88 65 65 65 65 65 65 65 65 65 79		06.88 01.87 01.86 06.90 06.91 01.86 04.92 05.89 07.91 07.91 08.86	12.93 03.93 12.92 12.93 12.93 10.92 12.93 05.91 12.93 03.92 12.93	- MA - ABS - ABS - ABS - ABS - ABS - ABS - ABS - ABS - ABS - ABS	03.0520-1722.3	691722		22,20/229x42 TopKit	LUC



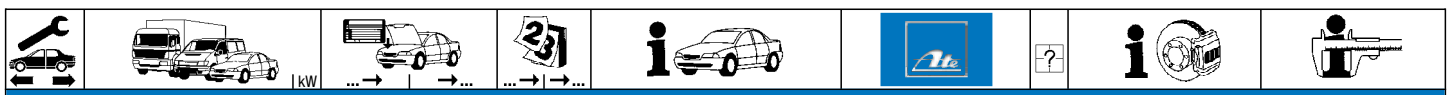



















RENAULT R21 Limousine (B48/L48_) (86-93)

	2.2 i (L 48S)	79	06.88	12.93	03.0520-1722.3	691722		22,20/229x42 TopKit	LUC
	1.4 (B/L 48D)	51	06.88	12.92	24.3727-1010.2	581010	2 ↓	L=1467	
	1.6 (B 48U)		06.90	03.92					
	1.6 (L 48U)		06.88	12.93 + (MA)					
	1.7 (B/L 481)	55	01.86	12.92					
	1.7 (B/L 482)	65	01.86	12.92					
	1.7 (B/L 484)		06.90	12.93					
	1.7 (B/L 48J)		01.87	05.91					
	1.7 (L 48M)	54	10.87	05.90					
	1.7 (L 48N)	64	10.87	05.90					
	1.7 i (B 48F)	54	08.86	12.93					
	1.7 i (B/L 48E)	66	08.86	12.93					
	1.9 D (B/L 48H)	47	05.89	12.92					
	1.9 D (B/L 48I)	47	04.92	12.93					
	2.1 D (B 48V)	53	09.89	12.93 - (MA)					
	2.1 D (B/L 480)	51	04.92	12.93					
	2.1 D (B/L 480)	53	04.92	12.93					
	2.1 D (L 48V)	53	05.89	12.93					
	2.1 TD (B/L 486)	65	01.86	12.92					
	1.6 (B/L 48U)		06.88	12.93	03.6583-0011.3	320102		BRL 8/3 (4)	ATE
	1.7 (B 482)	65	09.89	12.92 + (MA)					
	1.7 (L 482)	65	01.86	12.92 + (E) (MA)					
	1.7 (L 484)		06.90	12.93 - (D) (MA)					
	2.0 (L 489)		01.87	03.93					
	2.0 i (B 48R)	99	09.89	12.93 - ABS					
	2.0 i (B/L 483)		01.86	12.92 - ABS					
	2.0 i (B/L 48C)	88	06.90	12.93 - ABS					
	2.1 D (B 48V)	53	09.89	12.93 + (MA)					
	2.1 D (B/L 480)	53	04.92	12.93 - ABS					
	2.1 TD (B/L 487)	65	06.91	12.93 - ABS					
	2.1 TD (B/L 488)	65	01.86	10.92 - ABS					
	2.1 TD (B/L 48A)	65	04.92	12.93 - ABS					
	2.1 TD (B/L 48W)	65	05.89	05.91					
	2.1 TD (L 486)	65	01.86	10.92 + (E)					
	2.2 i (B/L 48K)	79	08.86	12.93 - ABS					
	2.2 i (L 48S)	79	06.88	12.93					
	1.4 (B/L 48D)	51	06.88	12.92	24.3728-1003.2	591003		L=1138	
	1.6 (L 48U)		06.88	12.93					
	1.7 (B 481)	55	09.89	12.92					
	1.7 (B 48J)		09.89	05.91					
	1.7 (B/L 482)	65	01.86	12.92					
	1.7 (B/L 484)		06.90	12.93					
	1.7 (L 481)	55	01.86	12.92					
	1.7 (L 48J)		01.87	05.91					
	1.7 (L 48M)	54	10.87	05.90					
	1.7 (L 48N)	64	10.87	05.90					
	1.7 i (B 48F)	54	09.89	12.93					
	1.7 i (B/L 48E)	66	08.86	12.93					

RENAULT R21 NEVADA (K48_) (86-95)

	1.6 (U)		06.88	12.95	03.2119-3389.3	010057		Thz 19,05	ATE
	1.7 (K 481)	55	07.86	12.95					
	1.7 (K 482)	65	07.86	12.95 - (E) (MA)					
	1.7 (K 484)		06.90	12.95					
	1.7 (K 48J)		07.86	12.95					
	1.7 (K 48M)	54	10.87	12.95					
	1.7 (K 48N)	64	10.87	12.95					
	1.7 (S 482)	65	07.86	12.95					
	1.7 i (K 48E)		07.86	12.95					
	1.7 i (K 48F)	54	07.86	12.95					
	1.9 D (K 48I)	47	04.92	12.95					
	1.9 D (K/S 48H)	47	05.89	12.95					
	1.7 (K 482)	65	06.92	12.95 - (E) (MA)	03.2120-2682.3	010118		Thz 20,64	ATE
	1.7 (K 482)	65	07.86	12.95 + (E) (MA)					
	1.7 (K 48E)		06.92	12.95					
	1.7 (S 481)	55	06.92	12.95					
	2.0 i (K 483)	85	07.86	04.89 - ABS					
	2.0 i (K 48C)	88	06.90	12.95 - ABS					
	2.1 D (K 486)		07.86	04.89					
	2.1 D (S 486)		07.86	12.95					
	2.1 D 4x4 (K 486)	48	07.86	12.95					
	2.1 TD (K 488)	65	07.86	04.89					
	2.2 i (K 48K)	79	07.86	04.89 - ABS					
	2.2 i (K 48S)	79	06.88	04.89					
	2.2 i 4x4 (K 48K)	79	07.86	12.95 - ABS					
	1.7 (K 482)	65	09.90	12.95 + (E) (MA)	03.2122-9631.3	010160		Thz 22,20	ATE
	2.0 i (K 483)	85	05.89	12.95 - ABS					
	2.0 i (K 48C)	88	06.90	12.95 - ABS					
	2.0 i (K 48R)	99	07.91	12.95 - ABS					
	2.1 D (K 480)	51	04.92	12.95 - ABS					
	2.1 D (K 486)		05.89	12.95					
	2.1 D (K 480)	53	04.92	12.95 - ABS					
	2.1 D (K/S 48V)	53	05.89	12.95					
	2.1 D (S 480)	53	04.92	12.95					
	2.1 TD (K 487)	65	06.91	12.95 - ABS					



										
RENAULT R21 NEVADA (K48_) (86-95)										
	2.1 TD (K 488)	65		05.89	12.95	03.2122-9631.3	010160		THz 22,20	ATE
	2.1 TD (K 48A)	65		04.92	12.95					
	2.1 TD (K 48P)	65		06.90	12.95					
	2.1 TD (K 48W)	65		05.89	12.95					
	2.2 i (K 48B)	79		04.93	12.95					
	2.2 i (K 48K)	79		05.89	12.95					
	2.2 i (K 48S)	79		05.89	12.95					
	1.7 (K/S 481)	55		07.86	12.95	24.3481-1615.5	240031		D=48, - Halter	LUC
	1.7 i (K 48F)	54		07.86	12.95	24.3481-1616.5	240032		D=48, - Halter	LUC
	1.9 D (K 48I)	47		04.92	12.95	24.0101-4806.2	260052		Bremssattel-Zubehör	LUC
	1.9 D (K/S 48H)	47		05.89	12.95					
	1.6 (U)			06.88	12.95	24.3481-1615.5	240031		D=48, - Halter	LUC
	1.7 (K 482)	65		07.86	12.95	24.3481-1616.5	240032		D=48, - Halter	LUC
	1.7 (K 484)			06.90	12.95	24.0101-4806.2	260052		Bremssattel-Zubehör	LUC
	1.7 (K 48J)			07.86	12.95					
	1.7 (K 48M)	54		10.87	12.95					
	1.7 (K 48N)	64		10.87	12.95					
	1.7 (S 482)	65		07.86	12.95					
	1.7 i (K 48E)			07.86	12.95					
	1.7 (K 482)	65		07.86	12.95	24.3541-1625.5	240045		D=54, - Halter	LUC
						24.3541-1626.5	240046		D=54, - Halter	LUC
	1.7 (K/S 481)	55		07.86	12.95	13.0460-3911.2	603911		20905 18,0 +/WK	BDX
	1.7 i (K 48F)	54		07.86	12.95	13.0460-2834.2	602834		21463 18,0 /WK/S	LUC
	1.9 D (K 48I)	47		04.92	12.95	13.0460-0411.2	610411		Belagsatz-Zubehör	BDX
	1.9 D (K/S 48H)	47		05.89	12.95					
	1.6 (U)			06.88	12.95	13.0460-2834.2	602834		21463 18,0 /WK/S	LUC
	1.7 (K 484)			06.90	12.95					
	1.7 (K 48J)			07.86	12.95					
	1.7 (K 48M)	54		10.87	12.95					
	1.7 (K 48N)	64		10.87	12.95					
	1.7 (K/S 482)	65		07.86	12.95					
	1.7 i (K 48E)			07.86	12.95					
	2.0 i (K 483)	85		07.86	12.95	13.0460-3933.2	603933		21016 17,0 +/WK	BDX
	2.0 i (K 48C)	88		06.90	12.95					
	2.0 i (K 48R)	99		07.91	12.95					
	2.1 D (K 480)	51		04.92	12.95					
	2.1 D (K/S 486)			07.86	12.95					
	2.1 D (K/S 480)	53		04.92	12.95					
	2.1 D (K/S 48V)	53		05.89	12.95					
	2.1 TD (K 487)	65		06.91	12.95					
	2.1 TD (K 488)	65		07.86	12.95					
	2.1 TD (K 48A)	65		04.92	12.95					
	2.1 TD (K 48P)	65		06.90	12.95					
	2.1 TD (K 48W)	65		05.89	12.95					
	2.2 i (K 48B)	79		04.93	12.95					
	2.2 i (K 48K)	79		07.86	12.95					
	2.2 i (K 48S)	79		06.88	12.95					
	1.6 (U)			06.88	12.95	24.0120-0125.1	420125		238 20,1 17,7 V +S +B	
	1.7 (K 484)			06.90	12.95					
	1.7 (K 48J)			07.86	12.95					
	1.7 (K 48M)	54		10.87	12.95					
	1.7 (K 48N)	64		10.87	12.95					
	1.7 (K/S 481)	55		07.86	12.95					
	1.7 (K/S 482)	65		07.86	12.95					
	1.7 i (K 48E)			07.86	12.95					
	1.7 i (K 48F)	54		07.86	12.95					
	1.9 D (K 48I)	47		04.92	12.95					
	1.9 D (K/S 48H)	47		05.89	12.95					
	2.0 i (K 483)	85		07.86	12.95	24.0120-0134.1	420134		265 20,5 17,7 V	
	2.0 i (K 48C)	88		06.90	12.95					
	2.1 D (K 480)	51		04.92	12.95					
	2.1 D (K 486)	48		07.86	12.95					
	2.1 D (K 480)	53		04.92	12.95					
	2.1 D (K 48V)	53		05.89	12.95					
	2.1 TD (K 487)	65		06.91	12.95					
	2.1 TD (K 488)	65		07.86	12.95					
	2.1 TD (K 48A)	65		04.92	12.95					
	2.1 TD (K 48P)	65		06.90	12.95					
	2.1 TD (K 48W)	65		05.89	12.95					
	2.2 i (K 48B)	79		04.93	12.95					
	2.2 i (K 48K)	79		07.86	12.95					
	2.2 i (K 48S)	79		06.88	12.95					
	2.0 i (K 48R)	99		07.91	12.95	24.0121-0103.1	421103		285 21,0 19,0 V	
	2.1 D (K 480)	51		04.92	12.95	24.0120-0135.1	420135		244 20,5 17,7 V	
	2.1 D (K 486)	48		07.86	12.95					
	2.1 D (K 480)	53		04.92	12.95					
	2.1 D (K 48V)	53		05.89	12.95					
	2.1 D (S 486)			07.86	12.95					
	2.1 D (S 480)	53		04.92	12.95					
	2.1 D (S 48V)	53		05.89	12.95					
	2.1 TD (K 488)	65		07.86	12.95					
	2.1 TD (K 48A)	65		04.92	12.95					



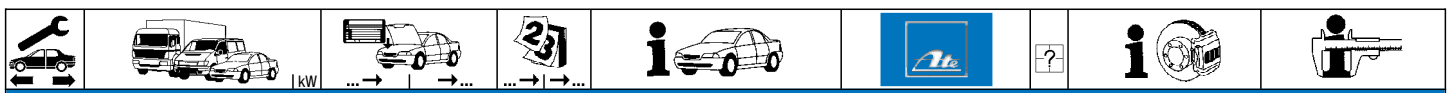

RENAULT R21 NEVADA (K48_) (86-95)															
	1.6 (U)		06.88	12.95	24.5111-0241.3	330680	2		L=242						
	1.7 (K 482)	65	07.86	12.95						- E MA					
	1.7 (K 484)		06.90	12.95											
	1.7 (K 48J)		07.86	12.95											
	1.7 (K 48M)	54	10.87	12.95											
	1.7 (K 48N)	64	10.87	12.95											
	1.7 (K/S 481)	55	07.86	12.95											
	1.7 (S 482)	65	07.86	12.95											
	1.7 i (K 48E)		07.86	12.95											
	1.7 i (K 48F)	54	07.86	12.95											
	1.9 D (K 48I)	47	04.92	12.95											
	1.9 D (K/S 48H)	47	05.89	12.95											
	1.7 (K 482)	65	07.86	12.95						+ E MA	24.5111-0300.3	330407	2	L=300	
	2.0 i (K 483)	85	07.86	12.95	- ABS	24.5111-0320.3	330487	2	L=320						
	2.0 i (K 48C)	88	06.90	12.95	- ABS										
	2.0 i (K 48R)	99	07.91	12.95	- ABS										
	2.1 D (K 480)	51	04.92	12.95	- ABS										
	2.1 D (K 480)	53	04.92	12.95	- ABS										
	2.1 D (K/S 486)		07.86	12.95											
	2.1 D (K/S 48V)	53	05.89	12.95											
	2.1 D (S 480)	53	04.92	12.95											
	2.1 TD (K 487)	65	06.91	12.95	- ABS										
	2.1 TD (K 488)	65	07.86	12.95											
	2.1 TD (K 48A)	65	04.92	12.95	- ABS										
	2.1 TD (K 48P)	65	06.90	12.95											
	2.1 TD (K 48W)	65	05.89	12.95											
2.2 i (K 48K)	79	07.86	12.95	- ABS											
2.2 i (K 48S)	79	06.88	12.95												
	2.0 i (K 483)	85	07.86	12.95	+ ABS	24.5111-0320.3	330487	2	L=320						
	2.0 i (K 48C)	88	06.90	12.95	+ ABS										
	2.0 i (K 48R)	99	07.91	12.95	+ ABS										
	2.1 D (K 480)	51	04.92	12.95	+ ABS										
	2.1 D (K 480)	53	04.92	12.95	+ ABS										
	2.1 TD (K 487)	65	06.91	12.95	+ ABS										
	2.1 TD (K 48A)	65	04.92	12.95	+ ABS										
	2.2 i (K 48K)	79	07.86	12.95	+ ABS										
		2.0 i (K 483)	85	05.87	12.95						24.0711-1403.3	360100		Radsensor L=1289	
		2.0 i (K 48C)	88	06.91	12.95										
		2.0 i (K 48R)	99	07.91	12.95										
		2.1 D (K 480)	51	04.92	12.95										
		2.1 D (K 480)	53	04.92	12.95										
2.1 D (K 48V)		53	05.89	12.95											
2.1 TD (K 487)		65	06.91	12.95											
2.1 TD (K 48A)		65	04.92	12.95											
2.2 i (K 48B)		79	04.93	12.95											
2.2 i (K 48K)		79	03.87	12.95											
		2.0 i (K 483)	85	07.86	12.95	+ ABS	13.0460-3961.2	603961		20336 14,0 +WK BDX 20410 15,0 + BRE Belagsatz-Zubehör BRE					
		2.0 i (K 48C)	88	06.90	12.95	+ ABS									
		2.0 i (K 48R)	99	07.91	12.95										
	2.1 D (K 480)	51	04.92	12.95	+ ABS										
	2.1 TD (K 487)	65	06.91	12.95	+ ABS										
	2.2 i (K 48B)	79	04.93	12.95	+ ABS										
	2.2 i (K 48K)	79	07.86	12.95	+ ABS										
		2.0 i (K 483)	85	07.86	12.95	+ ABS					24.0111-0122.1	411122		255 10,5 9,5	
		2.0 i (K 48C)	88	06.90	12.95	+ ABS									
		2.0 i (K 48R)	99	07.91	12.95										
		2.1 D (K 480)	51	04.92	12.95	+ ABS									
		2.1 TD (K 487)	65	06.91	12.95	+ ABS									
		2.2 i (K 48B)	79	04.93	12.95	+ ABS									
2.2 i (K 48K)		79	07.86	12.95	+ ABS										
		1.6 (U)		06.88	12.95	24.5229-0220.3	330399	2		L=220					
		1.7 (K 484)		06.90	12.95										
		1.7 (K 48J)		07.86	12.95										
		1.7 (K 48M)	54	10.87	12.95										
		1.7 (K 48N)	64	10.87	12.95										
		1.7 (K/S 481)	55	07.86	12.95										
	1.7 (K/S 482)	65	09.90	12.95											
	1.7 i (K 48E)		07.86	12.95											
	1.7 i (K 48F)	54	07.86	12.95											
	1.9 D (K 48I)	47	04.92	12.95											
	1.9 D (K/S 48H)	47	05.89	12.95											
	2.0 i (K 483)	85	05.89	12.95	- ABS										
	2.0 i (K 48C)	88	06.90	12.95	- ABS										
	2.0 i (K 48R)	99	07.91	12.95	- ABS										
	2.1 D (K 480)	51	04.92	12.95	- ABS										
	2.1 D (K 486)		05.89	12.95											
	2.1 D (K 480)	53	04.92	12.95	- ABS										
	2.1 D (K/S 48V)	53	05.89	12.95											
	2.1 D (S 480)	53	04.92	12.95											
	2.1 TD (K 487)	65	06.91	12.95	- ABS										
	2.1 TD (K 488)	65	05.89	12.95											
	2.1 TD (K 48A)	65	04.92	12.95	- ABS										
	2.1 TD (K 48P)	65	06.90	12.95											
2.1 TD (K 48W)	65	05.89	12.95												
2.2 i (K 48B)	79	04.93	12.95	- ABS											
2.2 i (K 48K)	79	05.89	12.95	- ABS											





























RENAULT R21 NEVADA (K48_) (86-95)















	2.2 i (K 48S)	79		05.89	12.95		24.5229-0220.3	330399	2		L=220
	2.0 i (K 483)	85		07.86	12.95 + ABS		24.5229-0220.3	330399	2	Länge beachten ¹⁾	L=220
	2.0 i (K 48C)	88		06.90	12.95 + ABS		24.5111-0260.3	330408	2	Länge beachten ¹⁾	L=260
	2.0 i (K 48R)	99		07.91	12.95 + ABS		24.5229-0285.3	330032	2	Länge beachten ¹⁾	L=285
	2.1 D (K 480)	51		04.92	12.95 + ABS						
	2.1 D (K 480)	53		04.92	12.95 + ABS						
	2.1 TD (K 487)	65		06.91	12.95 + ABS						
	2.1 TD (K 48A)	65		04.92	12.95 + ABS						
	2.2 i (K 48B)	79		04.93	12.95 + ABS						
	2.2 i (K 48K)	79		07.86	12.95 + ABS						
	2.2 i (K 48S)	79		06.88	12.95 + ABS						
	1.6 (U)			06.88	12.95		24.3222-1122.3	020335			Rz 22,20
	1.7 (K 484)			06.90	12.95		24.3222-1123.3	020336			Rz 22,20
	1.7 (K 48J)			07.86	12.95						
	1.7 (K 48M)	54		10.87	12.95						
	1.7 (K 48N)	64		10.87	12.95						
	1.7 (K/S 481)	55		07.86	12.95						
	1.7 (K/S 482)	65		07.86	12.95						
	1.7 i (K 48E)			07.86	12.95						
	1.7 i (K 48F)	54		07.86	12.95						
	1.9 D (K 48I)	47		04.92	12.95						
	1.9 D (K/S 48H)	47		05.89	12.95						
	2.0 i (K 483)	85		07.86	12.95 - ABS						
	2.0 i (K 48C)	88		06.90	12.95 - ABS						
	2.1 D (K 480)	51		04.92	12.95 - ABS						
	2.1 D (K 486)			07.86	12.95						
	2.1 D (K/S 480)	53		04.92	12.95						
	2.1 D (K/S 48V)	53		05.89	12.95						
	2.1 D (S 486)			07.86	12.95						
	2.1 TD (K 487)	65		06.91	12.95 - ABS						
	2.1 TD (K 488)	65		07.86	12.95						
	2.1 TD (K 48A)	65		04.92	12.95						
	2.1 TD (K 48P)	65		06.90	12.95						
	2.1 TD (K 48W)	65		05.89	12.95						
	2.2 i (K 48B)	79		04.93	12.95 - ABS						
	2.2 i (K 48K)	79		07.86	12.95 - ABS						
	2.2 i (K 48S)	79		06.88	12.95						
	2.1 D 4x4 (K 486)	48		07.86	12.95		24.3220-1115.3	020312			Rz 20,64
	2.2 i 4x4 (K 48K)	79		07.86	12.95 - ABS						BDX
	1.6 (U)			06.88	12.95		03.0137-0271.2	650271			229 x 42 HEB
	1.7 (K 484)			06.90	12.95		03.0137-9027.2	669027			Bremsbacken-Zubehör
	1.7 (K 48J)			07.86	12.95						LUC
	1.7 (K 48M)	54		10.87	12.95						LUC
	1.7 (K 48N)	64		10.87	12.95						
	1.7 (K/S 481)	55		07.86	12.95						
	1.7 (K/S 482)	65		07.86	12.95						
	1.7 i (K 48E)			07.86	12.95						
	1.7 i (K 48F)	54		07.86	12.95						
	1.9 D (K 48I)	47		04.92	12.95						
	1.9 D (K/S 48H)	47		05.89	12.95						
	2.0 i (K 483)	85		07.86	12.95 - ABS						
	2.0 i (K 48C)	88		06.90	12.95 - ABS						
	2.1 D (K 480)	51		04.92	12.95 - ABS						
	2.1 D (K 486)			07.86	12.95						
	2.1 D (K/S 480)	53		04.92	12.95						
	2.1 D (K/S 48V)	53		05.89	12.95						
	2.1 D (S 486)			07.86	12.95						
	2.1 TD (K 487)	65		06.91	12.95 - ABS						
	2.1 TD (K 488)	65		07.86	12.95						
	2.1 TD (K 48A)	65		04.92	12.95						
	2.1 TD (K 48P)	65		06.90	12.95						
	2.1 TD (K 48W)	65		05.89	12.95						
	2.2 i (K 48B)	79		04.93	12.95 - ABS						
	2.2 i (K 48K)	79		07.86	12.95 - ABS						
	2.2 i (K 48S)	79		06.88	12.95						
	1.6 (U)			06.88	12.95		24.0222-8015.1	480055			229/229,5 x 52,5
	1.7 (K 484)			06.90	12.95		24.0222-8019.2	480087			229/229,5 x 52,5
	1.7 (K 48J)			07.86	12.95						
	1.7 (K 48M)	54		10.87	12.95						
	1.7 (K 48N)	64		10.87	12.95						
	1.7 (K/S 481)	55		07.86	12.95						
	1.7 (K/S 482)	65		07.86	12.95						
	1.7 i (K 48E)			07.86	12.95						
	1.7 i (K 48F)	54		07.86	12.95						
	1.9 D (K 48I)	47		04.92	12.95						
	1.9 D (K/S 48H)	47		05.89	12.95						
	2.0 i (K 483)	85		07.86	12.95 - ABS						
	2.0 i (K 48C)	88		06.90	12.95 - ABS						
	2.1 D (K 480)	51		04.92	12.95 - ABS						
	2.1 D (K 486)			07.86	12.95						
	2.1 D (K/S 480)	53		04.92	12.95						
	2.1 D (K/S 48V)	53		05.89	12.95						
	2.1 D (S 486)			07.86	12.95						
	2.1 TD (K 487)	65		06.91	12.95 - ABS						
	2.1 TD (K 488)	65		07.86	12.95						
	2.1 TD (K 48A)	65		04.92	12.95						
	2.1 TD (K 48P)	65		06.90	12.95						
	2.1 TD (K 48W)	65		05.89	12.95						

¹⁾ notice length / attenzione lunghezza / faire attention longueur / atención largo

RENAULT R21 NEVADA (K48_) (86-95)										
	2.2 i (K 48B)	79		04.93	12.95	- ABS	24.0222-8015.1	480055		229/229,5 x 52,5
	2.2 i (K 48K)	79		07.86	12.95	- ABS	24.0222-8019.2	480087		229/229,5 x 52,5
	2.2 i (K 48S)	79		06.88	12.95					
	1.6 (U)			06.88	12.95		03.0520-1722.3	691722		22,20/229x42 TopKit LUC
	1.7 (K 484)			06.90	12.95					
	1.7 (K 48J)			07.86	12.95					
	1.7 (K 48M)	54		10.87	12.95					
	1.7 (K 48N)	64		10.87	12.95					
	1.7 (K/S 481)	55		07.86	12.95					
	1.7 (K/S 482)	65		07.86	12.95					
	1.7 i (K 48E)			07.86	12.95					
	1.7 i (K 48F)	54		07.86	12.95					
	1.9 D (K 48I)	47		04.92	12.95					
	1.9 D (K/S 48H)	47		05.89	12.95					
	2.0 i (K 483)	85		07.86	12.95	- ABS				
	2.0 i (K 48C)	88		06.90	12.95	- ABS				
	2.1 D (K 480)	51		04.92	12.95	- ABS				
	2.1 D (K 486)			07.86	12.95					
	2.1 D (K/S 480)	53		04.92	12.95					
	2.1 D (K/S 48V)	53		05.89	12.95					
	2.1 D (S 486)			07.86	12.95					
	2.1 TD (K 487)	65		06.91	12.95	- ABS				
	2.1 TD (K 488)	65		07.86	12.95					
	2.1 TD (K 48A)	65		04.92	12.95					
	2.1 TD (K 48P)	65		06.90	12.95					
	2.1 TD (K 48W)	65		05.89	12.95					
	2.2 i (K 48B)	79		04.93	12.95	- ABS				
	2.2 i (K 48K)	79		07.86	12.95	- ABS				
	2.2 i (K 48S)	79		06.88	12.95					
	1.6 (U)			06.88	12.95		03.6583-0014.3	320104		BRL 8/3 (4) ATE
	1.7 (K 484)			06.90	12.95					
	1.7 (K 48J)			07.86	12.95					
	1.7 (K 48M)	54		10.87	12.95					
	1.7 (K 48N)	64		10.87	12.95					
	1.7 (K/S 481)	55		07.86	12.95					
	1.7 (K/S 482)	65		07.86	12.95					
	1.7 i (K 48E)			07.86	12.95					
	1.7 i (K 48F)	54		07.86	12.95					
	1.9 D (K 48I)	47		04.92	12.95					
	1.9 D (K/S 48H)	47		05.89	12.95					
	2.0 i (K 483)	85		07.86	12.95	- ABS				
	2.0 i (K 48C)	88		06.90	12.95	- ABS				
	2.1 D (K 480)	51		04.92	12.95	- ABS				
	2.1 D (K 486)			07.86	12.95					
	2.1 D (K 480)	53		04.92	12.95	- ABS				
	2.1 D (K/S 48V)	53		05.89	12.95					
	2.1 D (S 486)			07.86	12.95					
	2.1 D (S 480)	53		04.92	12.95					
	2.1 TD (K 487)	65		06.91	12.95	- ABS				
	2.1 TD (K 488)	65		07.86	12.95					
	2.1 TD (K 48A)	65		04.92	12.95	- ABS				
	2.1 TD (K 48P)	65		06.90	12.95					
	2.1 TD (K 48W)	65		05.89	12.95					
	2.2 i (K 48B)	79		04.93	12.95	- ABS				
	2.2 i (K 48K)	79		07.86	12.95	- ABS				
	2.2 i (K 48S)	79		06.88	12.95					
	1.6 (U)			06.88	12.95		24.3728-1003.2	591003		L=1138
	1.7 (K 481)	55		07.86	12.95					
	1.7 (K 482)	65		07.86	12.95					
	1.7 (K 484)			06.90	12.95					
	1.7 (K 48J)			07.86	12.95					
	1.7 (K 48M)	54		10.87	12.95					
	1.7 (K 48N)	64		10.87	12.95					
	1.7 (S 481)	55		07.86	12.95					
	1.7 (S 482)	65		07.86	12.95					
	1.7 i (K 48E)			07.86	12.95					
	1.7 i (K 48F)	54		07.86	12.95					
RENAULT R25 (84-92)										
	2.0 (B297)			01.84	12.92	- ABS	24.2120-1709.3	010276		Thz 20,64
	2.0 i (B29H)			01.87	12.92	- ABS				
	2.1 D (B296)			01.84	12.92	- ABS				
	2.1 TD (B290)			01.84	12.92	- ABS				
	2.1 TD (B29W)			06.89	02.90					
	2.2 i (B29B)			06.87	05.88					
	2.2 i (B29B)			06.88	12.92	- ABS				
	2.2 i (B29E)			06.87	05.88					
	2.2 i (B29E)			06.88	06.89	- ABS				
	2.0 i (B292)			06.88	12.92		24.2122-1501.3	010403		Thz 22,20
	2.0 i (B294)			02.90	12.92					
	2.2 i (B29B)			01.86	05.87		24.2123-1702.3	010431		Thz 23,81
	2.2 i (B29E)			01.84	05.87					
	2.5 T (B295)			01.85	06.89					
	2.5 T (B29G)			06.89	12.92					
	2.7 V6 (B298)			01.85	05.89					
	2.8 V6 (B293)			06.87	06.89					
	2.8 V6 (B29A)			01.87	05.88					

RENAULT R25 (84-92)											
	2.8 V6 (B29F)			06.87	12.92		24.2123-1702.3	010431		THz 23,81	
	2.0 (B297) 2.0 i (B292) 2.0 i (B294) 2.0 i (B29H) 2.1 D (B296) 2.1 TD (B290) 2.1 TD (B29W) 2.2 i (B29B) 2.2 i (B29B) 2.2 i (B29B) 2.2 i (B29E) 2.2 i (B29E) 2.2 i (B29E)			01.84 06.88 02.90 01.87 01.84 01.84 06.89 01.86 06.87 06.88 01.84 06.87 06.88	12.92 12.92 12.92 12.92 12.92 12.92 02.90 05.88 05.88 12.92 05.88 05.88 06.89		24.3541-1625.5 24.3541-1626.5	240045 240046	 	D=54, - Halter D=54, - Halter	LUC LUC
	2.0 (B297) 2.0 i (B292) 2.0 i (B294) 2.0 i (B29H) 2.1 D (B296) 2.1 TD (B290) 2.1 TD (B29W) 2.2 i (B29B) 2.2 i (B29B) 2.2 i (B29B) 2.2 i (B29E) 2.2 i (B29E) 2.2 i (B29E)			01.84 06.88 02.90 01.87 01.84 01.84 06.89 01.86 06.87 06.88 01.84 06.87 06.88	12.92 12.92 12.92 12.92 12.92 12.92 02.90 05.88 05.88 12.92 05.88 05.88 06.89		13.0460-2834.2	602834		21463 18,0 /WK/S	LUC
	2.2 i (B29B) 2.2 i (B29E) 2.5 T (B295) 2.5 T (B29G) 2.7 V6 (B298) 2.8 V6 (B293) 2.8 V6 (B29A) 2.8 V6 (B29F)			01.86 01.84 01.85 06.89 01.84 06.87 01.87 06.87	05.87 + ABS 05.87 + ABS 06.89 12.92 05.89 06.89 05.88 12.92		13.0460-2983.2	602983		21388 18,0 +/WK/S	LUC
	2.0 (B297) 2.0 i (B292) 2.0 i (B294) 2.0 i (B29H) 2.1 D (B296) 2.1 TD (B290) 2.1 TD (B29W) 2.2 i (B29B) 2.2 i (B29B) 2.2 i (B29B) 2.2 i (B29E) 2.2 i (B29E) 2.2 i (B29E)			01.84 06.88 02.90 01.87 01.84 01.84 06.89 01.86 06.87 06.88 01.84 06.87 06.88	12.92 12.92 12.92 12.92 12.92 12.92 02.90 05.88 05.88 12.92 05.88 05.88 06.89		24.0120-0126.1	420126		259 20,2 17,7 V +B	
	2.2 i (B29B) 2.2 i (B29E) 2.5 T (B295) 2.5 T (B29G) 2.7 V6 (B298) 2.8 V6 (B293) 2.8 V6 (B29A) 2.8 V6 (B29F)			01.86 01.84 01.85 06.89 01.84 06.87 01.87 06.87	05.87 + ABS 05.87 + ABS 06.89 12.92 05.89 06.89 05.88 12.92		24.0122-0143.1	422143		280 22,0 20,0 V	
	2.0 (B297) 2.0 i (B292) 2.0 i (B294) 2.0 i (B29H) 2.1 D (B296) 2.1 TD (B290) 2.1 TD (B29W) 2.2 i (B29B) 2.2 i (B29E) 2.5 T (B295) 2.5 T (B29G) 2.7 V6 (B298) 2.8 V6 (B293) 2.8 V6 (B29A) 2.8 V6 (B29F)			09.84 06.88 02.90 01.87 09.84 09.84 06.89 01.86 09.84 01.85 06.89 09.84 06.87 01.87 06.87	12.92 12.92 12.92 12.92 12.92 12.92 02.90 12.92 06.89 06.89 12.92 05.89 06.89 05.88 12.92		24.5111-0405.3	330410	2	L=405	
	2.0 (B297) 2.0 i (B292) 2.0 i (B294) 2.0 i (B29H) 2.1 D (B296) 2.1 TD (B290) 2.1 TD (B29W) 2.2 i (B29B) 2.2 i (B29E) 2.5 T (B295) 2.5 T (B29G) 2.7 V6 (B298) 2.8 V6 (B293)			01.84 06.88 02.90 01.87 01.84 01.84 06.89 01.86 01.84 01.85 06.89 01.84 06.87	12.92 + ABS 12.92 12.92 12.92 + ABS 12.92 + ABS 12.92 + ABS 02.90 + ABS 12.92 + ABS 06.89 06.89 12.92 05.89 06.89		13.0460-3961.2	603961		20336 14,0 +/WK	BDX

								
RENAULT R25 (84-92)								
	2.8 V6 (B29A) 2.8 V6 (B29F)		01.87 06.87	05.88 12.92	13.0460-3961.2	603961		20336 14,0 +/WK BDX
	2.0 (B297) 2.0 i (B292) 2.0 i (B294) 2.0 i (B29H) 2.1 D (B296) 2.1 TD (B290) 2.1 TD (B29W) 2.2 i (B29B) 2.2 i (B29E)		01.84 06.88 02.90 01.87 01.84 01.84 06.89 06.87 06.87	12.92 + ABS 12.92 12.92 12.92 + ABS 12.92 + ABS 12.92 + ABS 02.90 + ABS 12.92 + ABS 06.89 + ABS	24.0112-0134.1	412134		254 12,0 10,5
	2.2 i (B29B) 2.2 i (B29E) 2.5 T (B295) 2.5 T (B29G) 2.7 V6 (B298) 2.8 V6 (B293) 2.8 V6 (B29A) 2.8 V6 (B29F)		01.86 01.84 01.85 06.89 01.84 06.87 01.87 06.87	05.87 + ABS 05.87 + ABS 06.89 12.92 05.89 06.89 05.88 12.92	24.0112-0133.1	412133		254 12,0 10,5
	2.0 (B297) 2.0 i (B292) 2.0 i (B294) 2.0 i (B29H) 2.1 D (B296) 2.1 TD (B290) 2.1 TD (B29W) 2.2 i (B29B) 2.2 i (B29E) 2.5 T (B295) 2.7 V6 (B298) 2.8 V6 (B293) 2.8 V6 (B29A) 2.8 V6 (B29F)		01.84 06.88 02.90 01.87 01.84 01.84 06.89 01.86 01.84 01.85 01.84 06.87 01.87 06.87	12.92 - ABS 12.92 - ABS 12.92 - ABS 12.92 - ABS 12.92 - ABS 12.92 - ABS 02.90 - ABS 12.92 - ABS 06.89 - ABS 06.89 - ABS 05.89 - ABS 05.88 - ABS 05.88 - ABS 05.88 - ABS	24.5229-0240.3	330400	2 ▣	L=242
	2.0 (B297) 2.0 i (B292) 2.0 i (B294) 2.0 i (B29H) 2.1 D (B296) 2.1 TD (B290) 2.1 TD (B29W) 2.2 i (B29B) 2.2 i (B29E) 2.5 T (B295) 2.5 T (B29G) 2.7 V6 (B298) 2.8 V6 (B293) 2.8 V6 (B29A) 2.8 V6 (B29F)		01.84 06.88 02.90 01.87 01.84 01.84 06.89 01.86 01.84 01.85 06.89 01.84 06.87 01.87 06.87	12.92 + ABS 12.92 + ABS 12.92 + ABS 12.92 + ABS 12.92 + ABS 12.92 + ABS 02.90 + ABS 12.92 + ABS 06.89 + ABS 06.89 + ABS 12.92 + ABS 05.89 + ABS 06.89 + ABS 05.88 + ABS 12.92 + ABS	24.5229-0240.3 24.5111-0150.3	330400 330497	2 ▣ 2	L=242 L=150
	2.0 (B297) 2.0 i (B29H) 2.1 D (B296) 2.1 TD (B290) 2.1 TD (B29W) 2.2 i (B29B) 2.2 i (B29E)		01.84 01.87 01.84 01.84 06.89 01.86 01.84	12.92 - ABS 12.92 - ABS 12.92 - ABS 12.92 - ABS 02.90 - ABS 12.92 - ABS 06.89 - ABS	24.3222-1108.3 24.3222-1109.3 24.3222-1609.3	020263 020264 020279	▣ ▣ ▣	Rz 22,20 BDX Rz 22,20 BDX Rz 22,20 LUC
	2.0 (B297) 2.0 i (B29H) 2.1 D (B296) 2.1 TD (B290) 2.1 TD (B29W) 2.2 i (B29B) 2.2 i (B29E)		01.84 01.87 01.84 01.84 06.89 01.86 01.84	12.92 - ABS 12.92 - ABS 12.92 - ABS 12.92 - ABS 02.90 - ABS 12.92 - ABS 06.89 - ABS	03.0137-0139.2 03.0137-0124.2 03.0137-0271.2 03.0137-9020.2	650139 650124 650271 669020		229 x 42 BDX 229 x 42 HEB AUT BDX 229 x 42 HEB LUC Bremsbacken-Zubehör BDX
	2.0 (B297) 2.0 i (B29H) 2.1 D (B296) 2.1 TD (B290) 2.1 TD (B29W) 2.2 i (B29B) 2.2 i (B29E)		01.84 01.87 01.84 01.84 06.89 01.86 01.84	12.92 - ABS 12.92 - ABS 12.92 - ABS 12.92 - ABS 02.90 - ABS 12.92 - ABS 06.89 - ABS	24.0222-8015.1 24.0222-8019.2	480055 480087		229/229,5 x 52,5 229/229,5 x 52,5
	2.0 (B297) 2.0 i (B29H) 2.1 D (B296) 2.1 TD (B290) 2.1 TD (B29W) 2.2 i (B29B) 2.2 i (B29E)		01.84 01.87 01.84 01.84 06.89 01.86 01.84	12.92 - ABS 12.92 - ABS 12.92 - ABS 12.92 - ABS 02.90 - ABS 12.92 - ABS 06.89 - ABS	03.0520-0522.3	690522		22,20/229x42 TopKit BDX
	2.0 (B297) 2.0 i (B292) 2.0 i (B294) 2.0 i (B29H) 2.1 D (B296) 2.1 TD (B290) 2.1 TD (B29W) 2.2 i (B29B) 2.2 i (B29E)		01.84 06.88 02.90 01.87 01.84 01.84 06.89 01.86 01.84	12.92 - ABS 12.92 - ABS 12.92 - ABS 12.92 - ABS 12.92 - ABS 12.92 - ABS 02.90 - ABS 12.92 - ABS 06.89 - ABS	24.3727-1036.2	581036	2 ▣	L=1020

RENAULT R25 (84-92)											
	2.0 (B297) 2.0 i (B292) 2.0 i (B294) 2.0 i (B29H) 2.1 D (B296) 2.1 TD (B290) 2.1 TD (B29W) 2.2 i (B29B) 2.2 i (B29E) 2.5 T (B295) 2.5 T (B29G) 2.7 V6 (B298) 2.8 V6 (B293) 2.8 V6 (B29A) 2.8 V6 (B29F)			01.84 06.88 02.90 01.87 01.84 01.84 06.89 01.86 01.84 01.85 06.89 01.86 06.87 01.87 06.87	12.92 + ABS 12.92 + ABS 12.92 + ABS 12.92 + ABS 12.92 + ABS 12.92 + ABS 02.90 + ABS 12.92 + ABS 06.89 + ABS 06.89 12.92 05.89 06.89 05.88 12.92	24.3727-1037.2	581037	2		L=1090	
	2.2 i (B29E) 2.7 V6 (B298)			01.84 01.84	05.88 05.88	24.2528-0908.3	040065			Nz 28,57	
RENAULT R30 (75-84)											
	2.1 TD (R1270)	63		01.82	12.84	24.2120-1709.3	010276			Thz 20,64	
	2.1 TD (R1270)	63		01.82	12.84	24.3541-1625.5 24.3541-1626.5	240045 240046	<input type="checkbox"/> <input type="checkbox"/>		D=54, - Halter D=54, - Halter	LUC LUC
	2.1 TD (R1270)	63		01.82	12.84	13.0460-2834.2	602834			21463 18,0 /WK/S	LUC
	2.6 V6 (R1275)	94		01.75	12.84	24.0124-0103.1	424103			253 24,0 22,0 V +B	
	2.6 V6 (R1275)	94		01.75	12.84	13.0460-3961.2	603961			20336 14,0 +/WK	BDX
	2.1 TD (R1270)	63		01.82	12.84	24.3222-1108.3 24.3222-1109.3 24.3222-1609.3	020263 020264 020279	<input type="checkbox"/> <input type="checkbox"/> <input type="checkbox"/>		Rz 22,20 Rz 22,20 Rz 22,20	BDX BDX LUC
	2.1 TD (R1270)	63		01.82	12.84	03.0137-0139.2 03.0137-0124.2 03.0137-0271.2 03.0137-9020.2	650139 650124 650271 669020			229 x 42 229 x 42 HEB AUT 229 x 42 HEB Bremsbacken-Zubehör	BDX BDX LUC BDX
	2.1 TD (R1270)	63		01.82	12.84	03.0520-0522.3	690522			22,20/229x42 TopKit	BDX
	2.6 V6 (R1275)	94		01.75	12.84	24.2528-0908.3	040065			Nz 28,57	
RENAULT TRAFIC I Bus (T5/T6/T7) (80-89)											
	1.4 1.6 1.6 4x4 1.7 2.0 2.0 2.0 4x4 2.1 D 2.1 D 4X4	35 48 48 50 58 59 59 43 43		03.80 01.84 03.80 06.86 07.80 06.86 06.86 03.86 05.85	04.89 06.86 08.86 04.89 04.85 04.89 04.89 04.89 02.89	03.2120-1142.3	010085			Thz 20,64	ATE
	1.4 1.6 1.6 4x4 1.7 2.0 2.0 2.1 D 2.1 D 4X4	35 48 48 50 58 59 43 43		01.85 01.85 01.85 06.86 01.85 01.85 01.85 05.85	04.89 06.86 08.86 04.89 04.85 04.89 04.89 02.89	13.0460-3969.2	603969			20926 18,5 /WK	BDX
	1.4 1.6 1.6 4x4 1.7 2.0 2.0 2.1 D 2.1 D 4X4	35 48 48 50 58 59 43 43		03.80 01.84 03.80 06.86 07.80 03.80 03.80 05.85	04.89 06.86 08.86 04.89 04.85 04.89 04.89 02.89	24.0124-0103.1	424103			253 24,0 22,0 V +B	
	1.4 1.6 1.6 4x4 1.7 2.0 2.0 2.0 4x4 2.1 D 2.1 D 4X4	35 48 48 50 58 59 59 43 43		03.80 01.84 03.80 06.86 07.80 06.86 06.86 03.85 05.85	04.89 06.86 06.86 04.89 04.85 04.89 04.89 04.89 02.89	24.5111-0320.3	330487	4		L=320	

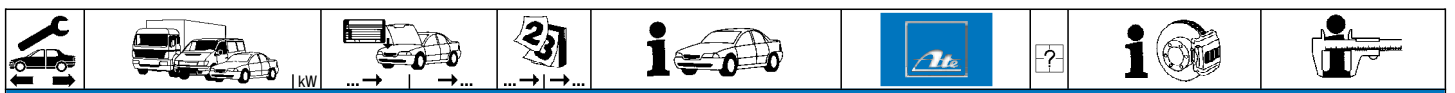

















RENAULT TRAFIC I Bus (T5/T6/T7) (80-89)

	1.4 1.6 1.6 4x4 1.7 2.0 2.0 2.0 4x4 2.1 D 2.1 D 4X4	35 48 48 50 58 59 59 43 43		03.80 01.84 03.80 06.86 07.80 06.86 06.86 03.85 05.85	04.89 06.86 06.86 04.89 04.85 04.89 04.89 04.89 02.89	24.5111-0386.3	330503	1		L=385	
	1.4 1.6 1.6 4x4 1.7 2.0 2.0 2.0 4x4 2.1 D 2.1 D 4X4	35 48 48 50 58 59 59 43 43		03.80 01.84 03.80 06.86 07.80 06.86 06.86 03.85 05.85	04.89 06.86 08.86 04.89 04.85 04.89 04.89 04.89 02.89	24.3223-1106.3	020317			Rz 23,81	BDX
	1.4 1.6 1.6 4x4 1.7 2.0 2.0 2.0 4x4 2.1 D 2.1 D 4X4	35 48 48 50 58 59 59 43 43		03.80 01.84 03.80 06.86 07.80 06.86 06.86 03.85 05.85	04.89 06.86 08.86 04.89 04.85 04.89 04.89 04.89 02.89	03.0137-0153.2 03.0137-9211.2	650153 669211			255 x 46 AUT Bremsbacken-Zubehör	BDX BDX
	1.4 1.6 1.6 4x4 1.7 2.0 2.0 2.0 4x4 2.1 D 2.1 D 4X4	35 48 48 50 58 59 59 43 43		03.80 01.84 03.80 06.86 07.80 06.86 06.86 03.85 05.85	04.89 06.86 08.86 04.89 04.85 04.89 04.89 04.89 02.89	03.0520-0723.3	690723			23,81/255x45 TopKit	BDX
	1.4 1.6 1.6 4x4 1.7 2.0 2.0 2.0 4x4 2.1 D 2.1 D 4X4	35 48 48 50 58 59 59 43 43		03.80 01.84 03.80 06.86 07.80 06.86 06.86 03.85 05.85	04.89 06.86 06.86 04.89 04.85 04.89 04.89 04.89 02.89	03.6512-0100.3	320077			BRL 1/2 (2)	ATE
	1.6 4x4 2.0 4x4	48 59		03.80 06.86	06.86 12.86	24.2528-0908.3	040065			Nz 28,57	

RENAULT TRAFIC I Kasten (T1/T2/T3/T4) (80-89)

	1.4 1.6 1.6 4x4 1.7 2.0 2.0 2.0 4x4 2.1 D	35 48 48 50 58 59 60 59 43		03.80 01.83 08.85 06.86 07.80 06.86 05.85 09.80	04.89 06.86 06.86 04.89 04.85 04.89 02.89 04.89	03.2120-1142.3	010085			THz 20,64	ATE
	1.4 1.6 1.7 2.0 2.0 2.0 2.1 D (T1--) 2.1 D (T1--) 2.1 D (T3--) 2.1 D (T3--) 2.1 D (T4--) 2.1 D (T4--)	35 48 50 58 59 60 43 43 43 43 43 43	0046160 0027230 0038050	03.80 01.83 06.86 07.80 03.80 05.85 09.80 09.80 09.80 09.80 09.80	04.89 06.86 04.89 04.85 04.89 02.89 04.89 04.89 + A DK 04.89 + B D E F N 04.89	13.0460-3968.2	603968			20488 18,5 +/-WK	BDX
	1.4 1.6 1.6 4x4 1.7 2.0 2.0 2.0 4x4 2.1 D 2.1 D 4x4	35 48 48 50 58 59 59 43 43		03.80 01.83 08.85 06.86 07.80 03.80 05.85 09.80 11.86	04.89 06.86 06.86 04.89 04.85 04.89 02.89 04.89 04.89	24.0124-0103.1	424103			253 24,0 22,0 V +B	
	1.4 1.6 1.6 4x4 1.7 2.0	35 48 48 50 58		03.80 01.83 08.85 06.86 07.80	04.89 06.86 06.86 04.89 04.85	24.5111-0320.3	330487	4		L=320	



RENAULT TRAFIC I Kasten (T1/T2/T3/T4) (80-89)									
									
	2.0	59		06.86	04.89	24.5111-0320.3	330487	4	L=320
	2.0	60		05.85	02.89				
	2.0 4x4	59		06.86	04.89				
	2.1 D	43		09.80	04.89				
	2.1 D 4x4	43		11.86	04.89				
	1.4	35		03.80	04.89	24.5111-0320.3	330487	1	L=320
	1.6	48		01.83	06.86				
	1.6 4x4	48		08.85	06.86				
	1.7	50		06.86	04.89				
	2.0	58		07.80	04.85				
	2.0	59		06.86	04.89				
	2.0	60		05.85	02.89				
	2.0 4x4	59		06.86	04.89				
	2.1 D	43		09.80	04.89				
	2.1 D 4x4	43		11.86	04.89				
	1.4	35		03.80	04.89	24.3222-1118.3	020315		Rz 22,20
	1.6	48		01.83	06.86				
	1.6 4x4	48		08.85	06.86				
	1.7	50		06.86	04.89				
	2.0	58		07.80	04.85				
	2.0	59		06.86	04.89				
	2.0	60		05.85	02.89				
	2.0 4x4	59		06.86	04.89				
	2.1 D (T1--)	43	0046160	09.80	04.89				
	2.1 D (T1--)	43		09.80	04.89				
	2.1 D (T3--)	43	0027230	09.80	04.89				
	2.1 D (T3--)	43		09.80	04.89				
	2.1 D (T4--)	43	0038050	09.80	04.89				
	2.1 D (T4--)	43		09.80	04.89				
	2.1 D (T1--)	43		09.80	04.89				
	2.1 D (T1--)	43	0046161	09.80	04.89				
	2.1 D (T3--)	43		09.80	04.89				
	2.1 D (T3--)	43	0027231	09.80	04.89				
	2.1 D (T4--)	43		09.80	04.89				
	2.1 D (T4--)	43	0038051	09.80	04.89				
	1.4	35		03.80	04.89	03.0137-0153.2	650153		255 x 46 AUT
	1.6	48		01.83	06.86	03.0137-9211.2	669211		Bremsbacken-Zubehör
	1.6 4x4	48		08.85	06.86				
	1.7	50		06.86	04.89				
	2.0	58		07.80	04.85				
	2.0	59		06.86	04.89				
	2.0	60		05.85	02.89				
	2.0 4x4	59		06.86	04.89				
	2.1 D (T1--)	43	0046160	09.80	04.89				
	2.1 D (T1--)	43		09.80	04.89				
	2.1 D (T3--)	43	0027230	09.80	04.89				
	2.1 D (T3--)	43		09.80	04.89				
	2.1 D (T4--)	43	0038050	09.80	04.89				
	2.1 D (T4--)	43		09.80	04.89				
	2.1 D (T1--)	43		09.80	04.89				
	2.1 D (T1--)	43	0046161	09.80	04.89				
	2.1 D (T3--)	43		09.80	04.89				
	2.1 D (T3--)	43	0027231	09.80	04.89				
	2.1 D (T4--)	43		09.80	04.89				
	2.1 D (T4--)	43	0038051	09.80	04.89				
	2.1 D (T1--)	43		09.80	04.89	03.0520-0723.3	690723		23,81/255x45 TopKit
	2.1 D (T1--)	43	0046161	09.80	04.89				
	2.1 D (T3--)	43		09.80	04.89				
	2.1 D (T3--)	43	0027231	09.80	04.89				
	2.1 D (T4--)	43		09.80	04.89				
	2.1 D (T4--)	43	0038051	09.80	04.89				
	1.4	35		03.80	04.89	03.6512-0100.3	320077		BRL 1/2 (2)
	1.6	48		01.83	06.86				
	1.6 4x4	48		08.85	06.86				
	1.7	50		06.86	04.89				
	2.0	58		07.80	04.85				
	2.0	59		06.86	04.89				
	2.0	60		05.85	02.89				
	2.0 4x4	59		06.86	04.89				
	2.1 D	43		09.80	04.89				
	2.1 D 4x4	43		11.86	04.89				
	1.6 4x4	48		08.86	12.86	24.2528-0908.3	040065		Nz 28,57
	1.7	50		06.86	04.89				
	2.0 4x4	59		06.86	12.86				
	2.1 D	43		09.80	12.86				
RENAULT TRAFIC I PROPULSION (PXX) (80-89)									
	1.7 (P3--)	50	0005150	06.86		03.2120-1142.3	010085		THz 20,64
	2.0 (P3--)	59	0005150	01.81					
	2.1 D (P3--)	43	0005150	01.81					
	1.7 (P3--)	50	0005151		04.89	03.2125-3801.3	010215		THz 25,40
	2.0 (P3--)	59	0005151		04.89				
	2.1 D (P3--)	43	0005151		04.89				

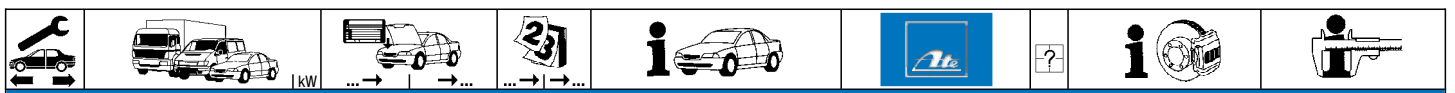

RENAULT TRAFIC I PROPULSION (PXX) (80-89)

	1.7 (P3--) 2.0 (P3--) 2.1 D (P3--)	50 59 43	0005150 0005150 0005150	06.86 01.81 01.81		13.0460-3968.2	603968			20488 18,5 +WK	BDX
	1.7 (P3--) 2.0 (P3--) 2.1 D (P3--)	50 59 43	0005151 0005151 0005151		04.89 04.89 04.89	13.0460-3969.2	603969			20926 18,5 /WK	BDX
	1.4 1.6 1.7 (P3--) 2.0 (P3--) 2.1 D (P3--) 2.5 D	35 48 50 59 43 51		03.80 03.80 01.81 01.81 01.81 03.80	04.89 04.89 04.89 04.89 04.89 04.89	24.0124-0103.1	424103			253 24,0 22,0 V +B	
	1.7 (P3--) 2.0 (P3--) 2.1 D (P3--)	50 59 43		01.81 01.81 01.81	04.89 04.89 04.89	24.5111-0320.3	330487	4		L=320	
	1.7 (P3--) 2.0 (P3--) 2.1 D (P3--)	50 59 43	0005150 0005150 0005150	01.81 01.81 01.81		24.3223-1106.3	020317			Rz 23,81	BDX
	1.7 (P3--) 2.0 (P3--) 2.1 D (P3--)	50 59 43	0005151 0005151 0005151		04.89 04.89 04.89	24.3225-1601.3	020359			Rz 25,40	LUC
	1.7 (P3--) 2.0 (P3--) 2.1 D (P3--)	50 59 43	0005150 0005150 0005150	01.81 01.81 01.81		03.0137-0153.2 03.0137-9211.2	650153 669211			255 x 46 AUT Bremsbacken-Zubehör	BDX BDX
	1.7 (P3--) 2.0 (P3--) 2.1 D (P3--)	50 59 43	0005151 0005151 0005151		04.89 04.89 04.89	03.0137-0036.2 03.0137-9013.2	650036 669013			254 x 57 Bremsbacken-Zubehör	LUC LUC
	1.7 (P3--) 2.0 (P3--) 2.1 D (P3--)	50 59 43	0005151 0005151 0005151		04.89 04.89 04.89	24.0225-4019.1	480305			254/254,8 x 70	
	1.7 (P3--) 2.0 (P3--) 2.1 D (P3--)	50 59 43	0005150 0005150 0005150	01.81 01.81 01.81		03.0520-0723.3	690723			23,81/255x45 TopKit	BDX
	1.4 1.6	35 48		01.81 01.84	04.89 04.89	03.6512-0100.3	320077			BRL 1/2 (2)	ATE
	1.4 1.6 1.7 2.0 2.1 D	35 48 50 59 43		01.81 01.84 06.86 06.86 03.85	04.89 04.89 04.89 04.89 04.89	24.2528-0908.3	040065			Nz 28,57	





























ROVER 200-Serie (XH) (85-89)





























	213 216 216 Vitesse	61 75		03.85 03.85 03.85	09.89 09.89 09.89	13.0460-5999.2	605999			21127 15,0 +WK	AKE
	213 216 216 Vitesse	61 75		03.85 03.85 03.85	09.89 09.89 09.89	24.0112-0102.1	412102			231 12,0 10,0	
	213 216	61		03.85 03.85	09.89 09.89	24.0117-0101.1	417101			231 17,0 15,0 V	AKE
	213 216	61		03.85 03.85	09.89 09.89	24.3219-1121.3 24.3219-1122.3	020363 020364			Rz 19,05 Rz 19,05	
	213 216 216 Vitesse	61 75		03.85 03.85 03.85	09.89 09.89 09.89	03.0137-0179.2 03.0137-9096.2	650179 669096			180 x 31 Bremsbacken-Zubehör	

ROVER 200-Serie (XW) (90-95)

	214 214 16V 216 216 16V 218 D 218 TD 220 16V 220 Turbo			10.89 01.90 10.89 01.90 09.91 01.91 01.91 01.93	10.95 10.95 10.95 10.95 10.95 10.95 10.95 10.95	24.3541-1813.5 24.3541-1814.5	240381 240382	+ ABS + ABS		D=54, - Halter D=54, - Halter	LUC LUC
	214 214 16V 216 216 16V 218 D 218 TD 220 16V 220 Turbo			10.89 01.90 10.89 01.90 09.91 01.91 01.91 01.93	10.95 10.95 10.95 10.95 10.95 10.95 10.95 10.95	13.0460-2805.2 13.0460-2803.2 13.0460-0142.2	602805 602803 610142	- ABS + ABS		21520 17,5 +WK 21515 17,5 +WK/S Belagsatz-Zubehör	LUC LUC
	214 214 16V			09.93 09.93	10.95 10.95	24.0113-0188.1	413188			238 12,7 10,7	
	214 214 16V 216 216 16V 218 D 218 TD 220 16V 220 Turbo			10.89 01.90 10.89 10.89 09.91 09.91 09.91 01.93	10.95 10.95 10.95 10.95 10.95 10.95 10.95 10.95	24.0121-0107.1	421107			262 21,0 19,0 V	



										
ROVER 200-Serie (XW) (90-95)										
	214 216 218 D 220 Turbo			10.89 10.89 09.91 01.93	10.95 10.95 10.95 10.95	13.0460-5998.2 13.0460-0430.2	605998 610430	21312 12,8 +/WK Belagsatz-Zubehör	AKE AKE	
	214 214 16V 216 16V 218 TD 220 16V			01.90 01.90 01.90 01.91 01.91	10.95 10.95 + ABS 10.95 + ABS 10.95 + ABS 10.95	24.0110-0212.1	410212	239 10,0 8,0 +S +B		
	214 216 218 D 220 Turbo			10.89 10.89 09.91 01.93	10.95 10.95 10.95 10.95	24.3219-1710.3	020386	Rz 19,05		
	214 216 218 D			10.89 01.91 01.91	10.95 - ABS 10.95 - ABS 10.95 - ABS	03.0137-0339.2 03.0137-9221.2	650339 669221	203 x 38 Bremsbacken-Zubehör		
	214 216 218 D			10.89 01.91 01.91	10.95 - ABS 10.95 - ABS 10.95 - ABS	03.0420-3719.3	683719	19,05/203x38 Kit	LUC	
ROVER 400-Serie (XW) (90-95)										
	414 414 16V 416 16V			04.90 01.90 04.90	04.95 04.95 04.95	24.3541-1813.5 24.3541-1814.5	240381 240382	+ ABS + ABS	D=54, - Halter D=54, - Halter	LUC LUC
	418 418 D 418 TD 420 16V 420 Turbo			09.91 01.91 01.91 01.91 01.93	04.95 04.95 04.95 04.95 04.95	24.3541-1813.5 24.3541-1814.5	240381 240382	+ ABS + ABS	D=54, - Halter D=54, - Halter	LUC LUC
	414 414 16V 416 16V 418 418 D 418 TD 420 16V 420 Turbo			04.90 01.90 04.90 09.91 01.91 01.91 01.91 01.93	04.95 04.95 04.95 04.95 04.95 04.95 04.95 04.95	13.0460-2805.2 13.0460-2803.2 13.0460-0142.2	602805 602803 610142	- ABS + ABS	21520 17,5 +/WK 21515 17,5 +/WK/S Belagsatz-Zubehör	LUC LUC
	414 414 16V			01.90 01.90	04.95 - ABS 04.95 - ABS	24.0113-0188.1	413188	238 12,7 10,7		
	414 414 16V 416 16V 418 D 418 TD 420 16V 420 Turbo			04.90 04.90 04.90 09.91 09.91 02.92 01.93	04.95 + ABS 04.95 + ABS 04.95 + ABS 04.95 04.95 04.95 04.95	24.0121-0107.1	421107	262 21,0 19,0 V		
	414 416 16V 418 418 TD			04.90 04.90 09.91 01.91	04.95 04.95 04.95 04.95	13.0460-5998.2 13.0460-0430.2	605998 610430	21312 12,8 +/WK Belagsatz-Zubehör	AKE AKE	
	414 414 16V 416 16V 418 TD 420 16V 420 Turbo			01.90 01.90 01.90 01.91 01.91 01.93	04.95 + ABS 04.95 + ABS 04.95 + ABS 04.95 + ABS 04.95 04.95	24.0110-0212.1	410212	239 10,0 8,0 +S +B		
	414 416 16V 418 D			01.90 01.90 01.91	04.95 - ABS 04.95 - ABS 04.95 - ABS	03.0137-0339.2 03.0137-9221.2	650339 669221	203 x 38 Bremsbacken-Zubehör		
ROVER 2000/2300/2600/3500 (SD) (76-86)										
	2.3 2.6 3.5 V8			09.77 09.77 06.76	12.81 - ⊕ 12.81 - ⊕ 12.81 - ⊕	13.0460-6910.2 13.0460-0414.2	606910 610414	20364 15,0 +/Zub Belagsatz-Zubehör	AP AP	
ROVER MINI (91-95)										
	1.3 MK I			01.91	04.95	13.0460-6914.2	606914	20038 14,0	AP	
	1.3 MK I			01.91	04.95	24.0110-0239.1	410239	214 9,6 8,6		
	1.3 MK I			01.91	04.95	24.3219-1401.3	020351	Rz 19,05	AP	
	1.3 MK I			01.91	04.95	03.0137-0080.2 03.0137-9205.2	650080 669205	178 x 32 Bremsbacken-Zubehör	AP AP	
	1.3 MK I			01.91	04.95	03.0420-2319.3	682319	19,05/178x32 Kit	AP	



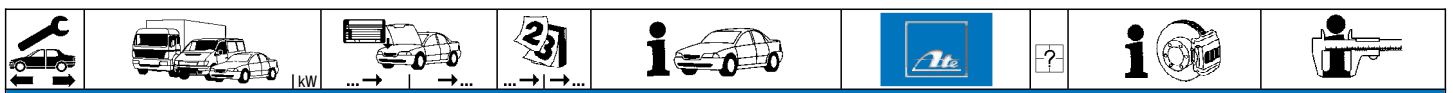

























											
SAAB 90 (84-87)											
	2.0			08.84	07.87		13.0460-0431.2	610431	Belagsatz-Zubehör	LUC	
	2.0			08.84	07.87		24.0113-0117.1	413117	280 12,7 11,7		
	2.0			08.84	07.87		24.5303-0275.3	331213	2	L=275	
	2.0			08.84	07.87		13.0441-3001.2	250041		Dichtungssatz	ATE
	2.0			08.84	07.87		24.0111-0120.1	411120		270 10,5 9,5	
	2.0			08.84	07.87		24.5310-0270.3	331369	2	L=270	
SAAB 99 (69-73)											
	1.7 1.9			12.68 05.70	08.70 08.73		13.0460-4035.2	604035		20173 15,0	ATE
	1.7 1.9			12.68 05.70	08.70 08.73		24.0111-0120.1	411120		270 10,5 9,5	
	1.7 1.9			12.68 05.70	08.70 08.73		13.0441-3001.2	250041		Dichtungssatz	ATE
	1.7 1.9			12.68 05.70	08.70 08.73		24.0111-0120.1	411120		270 10,5 9,5	
SAAB 99 (74-84)											
	1.9 2.0			09.73 09.73	08.74 12.74		13.0441-4819.2	250104		Dichtungssatz	ATE
	2.0 2.0 EMS			01.75 01.75	08.84 08.84		13.0460-0431.2	610431		Belagsatz-Zubehör	LUC
	1.9 2.0 2.0			09.73 09.73 01.75	08.74 12.74 08.84		24.0111-0120.1	411120		270 10,5 9,5	
		C6010841		01.75			24.0113-0141.1	413141		280 12,7 11,7	
		C06010842			08.84		24.0113-0117.1	413117		280 12,7 11,7	
	2.0 2.0 2.0 2.0 2.0 2.0 EMS 2.0 EMS	99766008979 99762022110 99766009735 99767004036 99762018780 99766007925 99767003176	99766009281		08.84 08.84 08.84 08.84 08.84 08.84		13.0441-3001.2	250041		Dichtungssatz	ATE
	1.9 2.0			09.73 09.73	08.74 08.84		24.0111-0120.1	411120		270 10,5 9,5	
	2.0			01.75	08.84		24.5310-0270.3	331369	2	L=270	
SAAB 900 (79-93)											
	2.0 16V 2.0 C 2.0 i 2.0 Turbo 2.1 16V			01.89 09.87 09.87 09.87 09.90	08.93 12.88 08.90 08.93 12.91		24.0101-3601.2	260044		Bremssattel-Zubehör	LUC
	2.0 C 2.0 EMS 2.0 i 2.0 Turbo			09.85 11.78 09.85 10.80	08.87 12.80 08.87 08.87		13.0460-0431.2	610431		Belagsatz-Zubehör	LUC
	2.0 16V 2.0 C 2.0 i 2.0 Turbo 2.1 16V			01.89 09.87 09.87 09.87 09.90	08.93 12.88 08.90 08.93 12.91		13.0460-2811.2	602811		21068 17,0 /S	LUC
	2.0 C 2.0 EMS			09.79 11.78	08.80 08.80		24.0113-0141.1	413141		280 12,7 11,7	
	2.0 C 2.0 EMS 2.0 i			09.80 09.80 11.80	08.87 12.80 08.87		24.0113-0117.1	413117		280 12,7 11,7	
	2.0 16V 2.0 C 2.0 i 2.0 Turbo 2.1 16V			01.89 09.87 09.87 09.87 09.90	08.93 12.88 08.90 08.93 12.91		24.0123-0101.1	423101		280 23,4 21,5 V	























































SAAB 900 (79-93)										
	2.0 16V 2.0 C 2.0 EMS 2.0 i 2.0 Turbo 2.1 16V			01.89 09.79 11.78 11.80 10.80 09.90	08.93 12.88 12.80 08.90 08.93 12.91		24.5303-0275.3	331213	2	L=275
	2.0 16V 2.0 i 2.0 Turbo 2.1 16V			09.89 09.89 09.89 09.90	08.93 08.90 08.93 12.91		24.0711-1154.1 24.0711-1155.1	360009 360010		Radsensor L=1295 Radsensor L=1295
	2.0 C 2.0 EMS 2.0 i			09.79 11.78 11.80	08.87 12.80 08.87		13.0441-3001.2	250041		Dichtungssatz ATE
	2.0 16V 2.0 C 2.0 i 2.0 Turbo 2.1 16V			01.89 09.87 09.87 09.87 09.90	08.93 12.88 08.90 08.93 12.91		11.3334-8002.2 11.0441-3302.2 11.0101-5407.2 11.8171-0008.1 11.8116-0047.1	220007 250004 260011 990049 390494	 2	D=33 Dichtungssatz Hülensatz Führungsbolzen Haltefeder ATE ATE ATE ATE ATE
	2.0 16V 2.0 C 2.0 i 2.0 Turbo 2.1 16V			01.89 09.87 09.87 09.87 09.90	08.93 12.88 08.90 08.93 12.91		13.0460-3306.2	603306		21089 15,0 + ATE
	2.0 C 2.0 EMS 2.0 i 2.0 Turbo			09.79 11.78 11.80 10.80	08.87 12.80 08.87 08.87		24.0111-0120.1	411120		270 10,5 9,5
	2.0 16V 2.0 C 2.0 i 2.0 Turbo 2.1 16V			01.89 09.87 09.87 09.87 09.90	08.93 12.88 08.90 08.93 12.91		24.0109-0130.1	409130		258 9,0 7,5
	2.0 C 2.0 EMS 2.0 i 2.0 Turbo			09.79 11.78 11.80 10.80	08.85 12.80 08.85 08.85		24.5310-0270.3	331369	2	L=270
	2.0 16V 2.0 C 2.0 i 2.0 Turbo			01.89 09.85 09.85 09.85	08.89 12.88 08.89 08.89		24.5310-0270.3 83.6155-0160.3	331369 330717	2 2	L=270 L=160
	2.0 16V 2.0 i 2.0 Turbo 2.1 16V			09.89 09.89 09.89 09.90	08.93 08.90 08.93 12.91		24.5310-0270.3	331369	2	L=270
	2.0 16V 2.0 i 2.0 Turbo 2.1 16V			09.89 09.89 09.89 09.90	08.93 08.90 08.93 12.91		24.0711-1157.1	360012		Radsensor L=1020
	2.0 C 2.0 EMS 2.0 i 2.0 Turbo			09.79 11.78 11.80 10.80	08.87 12.80 08.87 08.87		24.3727-1101.2	581101	2	L=1918



































SAAB 9000 (85-93)										
	2.0 16V 2.0 16V Turbo 2.3 16V 2.3 16V Turbo			08.92 08.92 08.92 08.92	08.93 + ABS/ - ASR/ - TCS 08.93 + ABS/ - ASR/ - TCS 08.93 + ABS/ - ASR/ - TCS 08.93 + ABS/ - ASR/ - TCS		10.6123-0522.3	010633		Thz 23,81 ATE
	2.0 16V 2.0 16V Turbo			09.86 09.86	08.89 08.87		24.0101-3601.2	260044		Bremssattel-Zubehör LUC
	2.0 16V 2.0 16V Turbo 2.3 16V 2.3 16V Turbo			09.89 09.87 09.89 09.89	08.93 08.93 08.93 08.93		11.0441-5702.2 11.0101-5407.2 11.8171-0008.1 11.8116-0073.1	250033 260011 990049 390498	2	Dichtungssatz Hülensatz Führungsbolzen Haltefeder ATE ATE ATE ATE
	2.0 16V 2.0 16V Turbo			09.84 09.84	08.89 08.87		13.0460-2811.2	602811		21068 17,0 /S LUC
	2.0 16V 2.0 16V Turbo 2.3 16V 2.3 16V Turbo			09.89 09.87 09.89 09.89	08.93 08.93 08.93 08.93		13.0460-5703.2	605703		21154 19,5 +/-WE ATE
	2.0 16V 2.0 16V Turbo			09.84 09.84	08.89 08.87		24.0123-0101.1	423101		280 23,4 21,5 V
	2.0 16V 2.0 16V Turbo 2.3 16V 2.3 16V Turbo			09.89 09.87 09.89 09.89	08.93 08.93 08.93 08.93		24.0125-0125.1	425125		280 25,0 23,0 V
	2.0 16V 2.0 16V Turbo 2.3 16V 2.3 16V Turbo			09.84 09.84 09.89 09.89	08.93 08.93 08.93 08.93		83.6169-0505.3	330288	2	L=505
	2.0 16V 2.0 16V Turbo			08.86 08.86	08.89 08.89		24.0712-1308.3 24.0712-1307.3	360032 360031	 	Radsensor L=1100 Radsensor L=1100

































									
SAAB 9000 (85-93)									
	2.0 16V 2.0 16V Turbo 2.3 16V 2.3 16V Turbo		09.84 09.84 09.89 09.89	08.93 08.93 08.93 08.93	11.3334-8002.2 11.0441-3302.2 11.0101-5407.2 11.8171-0008.1 11.8116-0047.2	220007 250004 260011 990049 390494	<input type="checkbox"/>	D=33 Dichtungssatz Hülzensatz Führungsbolzen Haltefeder	ATE ATE ATE ATE ATE
	2.0 16V 2.0 16V Turbo 2.3 16V 2.3 16V Turbo		09.84 09.84 09.89 09.89	08.93 08.93 08.93 08.93	13.0460-3306.2	603306		21089 15,0 +	ATE
	2.0 16V 2.0 16V Turbo 2.3 16V 2.3 16V Turbo		09.84 09.84 09.89 09.89	08.93 08.93 08.93 08.93	24.0109-0130.1	409130		258 9,0 7,5	
	2.0 16V 2.0 16V Turbo 2.3 16V 2.3 16V Turbo		09.84 09.84 09.89 09.89	08.93 08.93 08.93 08.93	83.6155-0327.3	330287	2	L=325	
	2.0 16V 2.0 16V Turbo		08.86 08.86	08.89 08.89	24.0712-1310.3 24.0712-1309.3	360034 360033	<input type="checkbox"/> <input type="checkbox"/>	Radsensor L=1120 Radsensor L=1120	
	2.0 16V 2.0 16V Turbo		09.86 09.86	08.89 08.89	24.3727-1105.2 24.3727-1107.2	581105 581107	<input type="checkbox"/> <input type="checkbox"/>	L=2025 L=1892	
	2.0 16V 2.0 16V Turbo 2.3 16V 2.3 16V Turbo		09.89 09.89 09.89 09.89	08.93 08.93 08.93 08.93	24.3727-1105.2 24.3727-1107.2	581105 581107	<input type="checkbox"/> <input type="checkbox"/>	L=2025 L=1892	
SEAT 124 (66-74)									
	alle Typen		01.66	12.74	24.0111-0130.1	411130		227 10,8 9,0 +B	
SEAT 127 (72-83)									
	127		01.72	12.82	24.2119-0806.3	010345		THz 19,05	
	alle Typen		01.72	12.83	24.0111-0130.1	411130		227 10,8 9,0 +B	
	alle Typen		01.72	12.82	24.3219-0801.3	020181		Rz 19,05	FI
SEAT 128 (69-84)									
	alle Typen		01.76	09.80	24.0111-0130.1	411130		227 10,8 9,0 +B	
	alle Typen		01.76	12.80	24.3219-0801.3	020181		Rz 19,05	FI
SEAT 131 (75-85)									
	alle Typen		01.75	12.85	24.0111-0130.1	411130		227 10,8 9,0 +B	
SEAT 132 (72-82)									
	alle Typen		05.73	12.82	24.2119-0806.3	010345		THz 19,05	
	alle Typen		05.73	12.82	24.0111-0130.1	411130		227 10,8 9,0 +B	
SEAT 600 (57-73)									
	alle Typen		01.57	12.73	24.3219-0801.3	020181		Rz 19,05	FI
SEAT 850 (64-73)									
	850 E Special		06.64	06.73	24.0111-0130.1	411130		227 10,8 9,0 +B	
	alle Typen		06.64	06.73	24.3219-0801.3	020181		Rz 19,05	FI
SEAT FURA (82-86)									
	0.9 1.4		02.82 02.82	12.86 06.86	13.0460-3936.2 13.0460-2997.2	603936 602997		20073 17,3 20708 15,8 /S	BDX LUC





























									
SEAT FURA (82-86)									
	0.9			02.82	12.86		24.0111-0130.1	411130	227 10,8 9,0 +B
SEAT IBIZA I (85-92)									
	0.9 1.2 1.5 1.5 i 1.7 D			11.86 05.85 05.85 04.88 05.85	01.93 01.93 01.93 01.93 01.93		03.2120-2031.3	010106	THz 20,64 ATE
	0.9 1.2 1.5 1.5 i 1.7 D 1.7 i			11.86 05.85 05.85 04.88 05.85 01.92	01.93 01.93 01.93 01.93 01.93 01.93		13.0460-3939.2 13.0460-3940.2 13.0460-0410.2	603939 603940 610410	20775 18,0 /WE 20775 18,0 /WK Belagsatz-Zubehör BDX BDX
	0.9 1.2 1.5 1.7 D	63		11.86 05.85 05.85 05.85	01.93 01.93 01.93 01.93		24.0111-0130.1	411130	227 10,8 9,0 +B
	1.5 i	66		04.88	01.93		24.0111-0129.1	411129	251 11,0 9,5
	1.5 i 1.7 i	74		04.88 01.92	01.93 01.93		24.0120-0157.1	420157	251 20,0 18,0 V
	0.9 1.2 1.5 1.5 i 1.7 D 1.7 i			11.86 05.85 05.85 04.88 05.85 01.92	01.93 01.93 01.93 01.93 01.93 01.93		24.5112-0412.3	330569	2 L=410
	0.9 1.2 1.5 1.5 i 1.7 D 1.7 i			11.86 05.85 05.85 04.88 05.85 01.92	01.93 01.93 01.93 01.93 01.93 01.93		24.5223-0294.3	330576	2 L=294
	0.9 1.2 1.5 1.5 i 1.7 D 1.7 i			11.86 05.85 05.85 04.88 05.85 01.92	01.93 01.93 01.93 01.93 01.93 01.93		24.3217-1115.3	020310	Rz 17,46 FI
	0.9 1.2 1.5 1.5 i 1.7 D 1.7 i			11.86 05.85 05.85 04.88 05.85 01.92	01.93 01.93 01.93 01.93 01.93 01.93		03.0137-0015.2 03.0137-9021.2	650015 669021	185 x 31 AUT Bremsbacken-Zubehör FI FI
	0.9 1.2 1.5 1.5 i 1.7 D 1.7 i			11.86 05.85 05.85 04.88 05.85 01.92	01.93 01.93 01.93 01.93 01.93 01.93		24.0218-5001.1	480012	185/186,8 x 37
	0.9 1.2 1.5 1.5 i 1.7 D 1.7 i			11.86 05.85 05.85 04.88 05.85 01.92	01.93 01.93 01.93 01.93 01.93 01.93		03.0420-0917.3	680917	17,46/185x31 Kit FI
	0.9 1.2 1.5 1.5 i 1.7 D			11.86 05.85 05.85 04.88 05.85	01.93 01.93 01.93 01.93 01.93		24.3727-2701.2	582701	1 L=2275
SEAT PANDA (80-86)									
	30 45			10.80 10.80	12.86 12.86		03.0137-0015.2 03.0137-9021.2	650015 669021	185 x 31 AUT Bremsbacken-Zubehör FI FI
SEAT MALAGA (85-92)									
	1.2 1.5 1.5 i 1.7 D			09.85 09.85 09.87 09.85	12.92 12.92 12.92 12.92		03.2120-2031.3	010106	THz 20,64 ATE
	1.2 1.5 1.5 i 1.7 D			09.85 09.85 09.87 09.85	12.92 12.92 12.92 12.92		13.0460-3939.2 13.0460-3940.2 13.0460-0410.2	603939 603940 610410	20775 18,0 /WE 20775 18,0 /WK Belagsatz-Zubehör BDX BDX
	1.2 1.5 1.7 D	63		09.85 09.85 09.85	12.92 12.92 12.92		24.0111-0130.1	411130	227 10,8 9,0 +B
	1.5 i	66		09.87	12.92		24.0111-0129.1	411129	251 11,0 9,5
	1.5 i	74		02.88	12.89		24.0120-0157.1	420157	251 20,0 18,0 V













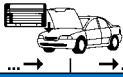











									
SEAT MALAGA (85-92)									
	1.2 1.5 1.5 i 1.7 D			09.85 12.92 09.85 12.92 09.87 12.92 09.85 12.92		24.5112-0412.3	330569	2	L=410
	1.2 1.5 1.5 i 1.7 D			09.85 12.92 09.85 12.92 09.87 12.92 09.85 12.92		24.5223-0294.3	330576	2	L=294
	1.2 1.5 1.5 i 1.7 D			09.85 12.92 09.85 12.92 09.87 12.92 09.85 12.92		24.3217-1115.3	020310		Rz 17,46 FI
	1.2 1.5 1.5 i 1.7 D			09.85 12.92 09.85 12.92 09.87 12.92 09.85 12.92		03.0137-0015.2 03.0137-9021.2	650015 669021		185 x 31 AUT Bremsbacken-Zubehör FI
	1.2 1.5 1.5 i 1.7 D			09.85 12.92 09.85 12.92 09.87 12.92 09.85 12.92		24.0218-5001.1	480012		185/186,8 x 37
	1.2 1.5 1.5 i 1.7 D			09.85 12.92 09.85 12.92 09.87 12.92 09.85 12.92		03.0420-0917.3	680917		17,46/185x31 Kit FI
	1.2 1.5 1.5 i 1.7 D			09.85 12.92 09.85 12.92 09.87 12.92 09.85 12.92		24.3727-2701.2	582701	1 	L=2275
SEAT RITMO (79-83)									
	60 65 75			01.79 12.83 01.79 12.83 01.79 12.83		24.0111-0130.1	411130		227 10,8 9,0 +B
SEAT RONDA (83-86)									
	1.2 1.4 1.5 1.6 1.7 D			06.83 07.86 06.82 07.86 09.85 07.86 06.83 08.85 06.83 07.86		03.2120-2031.3	010106		THz 20,64 ATE
	1.2 1.4 1.5 1.6 1.7 D			06.83 07.86 06.82 07.86 09.85 07.86 06.83 08.85 06.83 07.86		13.0460-3940.2 13.0460-0410.2	603940 610410		20775 18,0 /WK Belagsatz-Zubehör BDX
	1.2 1.4 1.5 1.6 1.7 D			06.83 07.86 06.82 07.86 09.85 07.86 06.83 08.85 06.83 07.86		24.0111-0130.1	411130		227 10,8 9,0 +B
	1.2 1.4 1.5 1.6 1.7 D			06.83 07.86 06.82 07.86 09.85 07.86 06.83 08.85 06.83 07.86		24.5112-0412.3	330569	2	L=410
	1.2 1.4 1.5 1.6 1.7 D			06.83 07.86 06.82 07.86 09.85 07.86 06.83 08.85 06.83 07.86		24.3217-1115.3	020310		Rz 17,46 FI
	1.2 1.4 1.5 1.6 1.7 D			06.83 07.86 06.82 07.86 09.85 07.86 06.83 08.85 06.83 07.86		03.0137-0015.2 03.0137-9021.2	650015 669021		185 x 31 AUT Bremsbacken-Zubehör FI
	1.2 1.4 1.5 1.6 1.7 D			06.83 07.86 06.82 07.86 09.85 07.86 06.83 08.85 06.83 07.86		24.0218-5001.1	480012		185/186,8 x 37
	1.2 1.4 1.5 1.6 1.7 D			06.83 07.86 06.82 07.86 09.85 07.86 06.83 08.85 06.83 07.86		03.0420-0917.3	680917		17,46/185x31 Kit FI
	1.2 1.4 1.5 1.6 1.7 D			06.83 07.86 06.82 07.86 09.85 07.86 06.83 08.85 06.83 07.86		24.3727-2701.2	582701	1 	L=2275

									
SEAT TERRA (87-96)									
	0.9 1.3 D 1.4 D		03.87 03.90 01.90	12.96 12.96 12.96	13.0460-3939.2 13.0460-0410.2	603939 610410		20775 18,0 /WE Belagsatz-Zubehör	BDX BDX
	0.9 1.3 D 1.4 D		03.87 03.90 01.90	12.96 12.96 12.96	24.0111-0130.1	411130		227 10,8 9,0 +B	
	0.9 1.3 D 1.4 D		09.90 09.90 09.90	12.96 12.96 12.96	24.3219-0803.3	020183		Rz 19,05	
	0.9 1.3 D 1.4 D		03.87 03.90 01.90	12.96 12.96 12.96	03.0137-0015.2 03.0137-9021.2	650015 669021		185 x 31 AUT Bremsbacken-Zubehör	FI FI
	0.9 1.3 D 1.4 D		03.87 03.90 01.90	12.96 12.96 12.96	24.3727-2705.2	582705	1 	L=3170	
SKODA FAVORIT (781) (87-95)									
	135 136		08.87 08.87	12.95 12.95	13.0460-2964.2	602964		20861 17,5 /S	LUC
	135 136		08.87 08.87	12.92 12.92	24.0113-0169.1	413169		236 12,8 11,4	
	135 136		01.93 01.93	03.94 03.94	24.0113-0193.1	413193		236 12,8 11,4	
	135 136		04.94 04.94	12.95 12.95	24.0113-0182.1	413182		236 12,8 11,4 +B	
	135 136		08.87 08.87	12.95 12.95	24.5166-0325.3	331293	2	L=325	
	135 136		08.87 08.87	12.95 12.95	24.5228-0235.3	330395	2	L=235	
	135 136		01.93 01.93	12.95 12.95	24.3219-1721.3	020422		Rz 19,05	
	135 136		08.87 08.87	12.92 12.92	03.0137-9133.2	669133		Bremsbacken-Zubehör	
	135 136		01.93 01.93	12.95 12.95	03.0137-0268.2 03.0137-9168.2	650268 669168		200 x 40 HEB Bremsbacken-Zubehör	VW VW
	135 136		01.93 01.93	12.95 12.95	24.0220-0018.1 24.0220-0718.2	480019 480209	ohne Sensorring ¹⁾ ohne Sensorring ¹⁾	200/201 x 50,5 - Lager 200/201,5 x 50,5 + Lager	
	135 136		01.93 01.93	12.95 12.95	03.0520-5319.3	695319		19,05/200x40 TopKit	
SKODA FORMAN (785) (91-95)									
	1.3 1.3 i		09.91 02.94	12.95 12.95	13.0460-2964.2	602964		20861 17,5 /S	LUC
	1.3 1.3 1.3 i		09.91 01.93 04.94	12.92 12.95 12.95	24.0113-0169.1 24.0113-0193.1 24.0113-0182.1	413169 413193 413182		236 12,8 11,4 236 12,8 11,4 236 12,8 11,4 +B	
	1.3 1.3 i		01.93 02.94	12.95 12.95	24.3219-1721.3	020422		Rz 19,05	
	1.3 1.3 1.3 i		09.91 01.93 02.94	12.92 12.95 12.95	03.0137-9133.2 03.0137-0268.2 03.0137-9168.2	669133 650268 669168		Bremsbacken-Zubehör 200 x 40 HEB Bremsbacken-Zubehör	VW VW
	1.3 1.3 i		01.93 02.94	12.95 12.95	24.0220-0018.1 24.0220-0718.2	480019 480209	ohne Sensorring ¹⁾ ohne Sensorring ¹⁾	200/201 x 50,5 - Lager 200/201,5 x 50,5 + Lager	
	1.3 1.3 i		01.93 02.94	12.95 12.95	03.0520-5319.3	695319		19,05/200x40 TopKit	
SKODA PICK-UP (93-95)									
	1.3		12.92	12.95	13.0460-2964.2	602964		20861 17,5 /S	LUC
	1.3		04.94	12.95	24.0113-0182.1	413182		236 12,8 11,4 +B	
	1.3		12.92	12.95	24.3222-1712.3	020424		Rz 22,20	
	1.3		12.92	12.95	03.0137-0268.2 03.0137-9168.2	650268 669168		200 x 40 HEB Bremsbacken-Zubehör	VW VW
	1.3		12.92	12.95	24.0220-0018.1 24.0220-0718.2	480019 480209	ohne Sensorring ¹⁾ ohne Sensorring ¹⁾	200/201 x 50,5 - Lager 200/201,5 x 50,5 + Lager	

¹⁾ without sensor ring / senza sensori / sans secours ABS / sin anillo sensor ABS

									
SKODA PICK-UP (93-95)									
	1.3			12.92	12.95		03.0520-7022.3	697022	22,20/200x40 TopKit VW
STEYR DAIMLER PUCH CITY-BUS (82-92)									
	City Bus			01.82	12.92		03.2123-6002.3	010184	THz 23,81 ATE
	City Bus			01.82	12.92		13.0441-4825.2	250107	Dichtungssatz ATE
	City Bus			01.82	12.92		13.0460-5032.2	605032	20588 16,5 /WE ATE
STEYR DAIMLER PUCH HAFLINGER (61-79)									
	AP 700 AP 703 APK 703			01.61 01.62 01.71	12.76 12.76 12.76		83.6204-0400.3	330311	L=400
	AP 700			01.62	12.62		03.3219-0203.3	020037	Rz 19,05
	AP 700 AP 703			01.61 01.62	12.62 12.62		83.6204-0220.3	330308	L=220
	AP 700 AP 703 APK 703			01.63 01.63 01.71	12.76 12.76 12.76		83.7704-0200.3 83.6204-0220.3	330825 330308	L=200 L=220
	AP 700 AP 703 APK 703			01.61 01.62 01.71	12.76 12.79 12.79		03.3215-0221.3	020013	Rz 15,87
STEYR DAIMLER PUCH PINZGAUER (71-76)									
	710 4x4 712 6x6			01.71 01.71	12.76 12.76		03.2123-1003.3	010175	THz 23,81 ATE
	710 4x4 712 6x6			01.71 01.71	12.76 12.76		83.6203-0400.3	330302	L=400
	710 4x4 712 6x6			01.71 01.71	12.76 12.76		03.3508-0401.3 03.0350-1906.2	310014 071906	Behälter Gz Reparatursatz
STEYR DAIMLER PUCH TRA 292 / TRA 395 (60-68)									
	TRA 292			01.60	12.68		83.6103-0320.3	330224	L=320
	TRA 292			01.60	12.68		83.6103-0450.3	330228	L=450
	TRA 395			01.60	12.68		03.2419-3307.3 03.0350-1906.2	030014 071906	Gz 19,05 Gz Reparatursatz
	TRA 395			01.60	12.68		83.6103-0320.3	330224	L=320
STEYR DAIMLER PUCH 380-10230 (58-88)									
	590 591 690 691			01.70 01.79 01.70 01.79	12.79 12.88 12.79 12.88		03.0370-1131.2	051131	Hz Reparatursatz
	1090			01.75	12.79		03.3115-2102.3	010247	Hz 15,87 ATE
	590 591 690 691 890			01.70 01.79 01.70 01.79 01.69	12.79 12.88 12.79 12.88 12.79		03.3508-0401.3	310014	Behälter
	590 690 890			01.70 01.70 01.69	12.79 12.79 12.79		83.6103-0550.3	330231	L=550
	480 586 680 780 870			01.60 01.62 01.58 01.62 01.75	12.70 12.67 12.70 12.68 12.79		03.2419-3307.3 03.0350-1906.2	030014 071906	Gz 19,05 Gz Reparatursatz
	480 586 680 780			01.60 01.62 01.58 01.62	12.70 12.67 12.70 12.68		83.6103-0320.3	330224	L=320

								
SUBARU LEGACY (89-93)								
	1.8 4WD (BJ3) 2.0 4WD (BC5) 2.0 4WD (BF5) 2.2 4WD 2.2 i Turbo	100	01.89 01.89 01.89 01.89 06.91	12.93 12.93 12.93 12.93 12.93	13.0460-5978.2	605978		21495 17,0 +WK
	1.8 4WD (BJ3) 2.0 4WD (BC5) 2.0 4WD (BF5) 2.2 4WD 2.0 i Turbo 2.2 i Turbo	100	01.89 01.89 01.89 01.89 06.91 06.91	12.93 12.93 12.93 12.93 12.93 12.93	24.0124-0141.1	424141		260 24,0 22,0 V +B
	1.8 4WD (BJ3) 2.0 4WD (BC5) 2.0 4WD (BF5)		01.89 01.89 01.89	12.93 12.93 12.93	03.0137-0302.2	650302		229 x 37 Bremsbacken-Zubehör
SUBARU LIBERO E10/E12 (87-93)								
	1.0 (KJ5) 1.0 4WD (KJ6) 1.2 4WD (KJ8)		01.87 01.87 01.87	04.93 04.93 04.93	13.0460-5963.2	605963		20958 16,0 AKE
	1.0 (KJ5) 1.0 4WD (KJ6) 1.2 4WD (KJ8)		01.87 01.87 01.87	04.93 04.93 04.93	24.0118-0115.1	418115		212 18,0 15,5 V
SUZUKI SJ410 (81-88)								
	1.0	33	09.81	12.88	13.0460-5961.2	605961		21252 15,0 + AKE
	1.0	33	09.81	12.88	24.0110-0192.1	410192		290 10,0 9,0
	1.0 1.0	33 33	09.81 06.83	05.83 12.88	03.0137-9128.2	669128		Bremsbacken-Zubehör
					03.0137-0306.2	650306		220 x 40
SUZUKI SJ413 (84-90)								
	1.3		09.84	08.90	13.0460-5966.2 13.0460-2997.2	605966 602997		21142 15,0 SUM 20708 15,8 /S LUC
	1.3		09.84	08.90	24.0110-0192.1	410192		290 10,0 9,0
	1.3		09.84	08.90	03.0137-0306.2	650306		220 x 40
SUZUKI ALTO (86-91)								
	0.8 (CA91/CB91)		01.86	08.91	13.0460-5916.2	605916		20731 15,3 AKE
	0.8 (CA91/CB91)		01.86	08.91	24.0110-0136.1	410136		215 10,0 8,0
	0.8 (CA91/CB91)		01.86	08.91	03.0137-0222.2 03.0137-9127.2	650222 669127		180 x 31 Bremsbacken-Zubehör
SUZUKI CAPPUCINO (92-95)								
	0.7 i 12V	47	02.92	08.95	13.0460-5985.2	605985		21333 15,0 +WK TOK
	0.7 i 12V	47	02.92	08.95	24.0117-0103.1	417103		231 17,0 15,0 V +B
SUZUKI SAMURAI (88-92)								
	1.0 1.3 (SJ413)		11.88 11.88	12.92 12.92	13.0460-5966.2 13.0460-2997.2	605966 602997		21142 15,0 SUM 20708 15,8 /S LUC
	1.0 1.3 (SJ413)		11.88 11.88	12.92 12.92	24.0110-0192.1	410192		290 10,0 9,0
	1.0 1.3 (SJ413)		11.88 11.88	12.92 12.92	03.0137-0306.2	650306		220 x 40
SUZUKI SUPER-CARRY (80-85)								
	0.8 (ST90)		10.80	02.85	03.0137-9128.2	669128		Bremsbacken-Zubehör

										
SUZUKI SUPER-CARRY (85-88)										
	1.0 (SK410)			03.85	02.88		13.0460-5916.2	605916	20731 15,3	AKE
	1.0 (SK410)			03.85	02.88		24.0110-0136.1	410136	215 10,0 8,0	
	1.0 Van			08.85	02.88		24.0110-0192.1	410192	290 10,0 9,0	
SUZUKI SWIFT I (84-89)										
	1.0 (SA310)			10.83	12.89		13.0460-5961.2	605961	21252 15,0 +	AKE
	1.3 (SA413)			10.84	12.89					
	1.3 i 16V GTi (SA413)			08.86	12.89		13.0460-5985.2	605985	21333 15,0 +/WK	TOK
	1.0 (SA310)			10.83	02.89		24.0110-0136.1	410136	215 10,0 8,0	
	1.3 (SA413)			10.84	02.89					
	1.0 (SA310)			03.89	12.89		24.0117-0103.1	417103	231 17,0 15,0 V +B	
	1.3 (SA413)			03.89	12.89					
SUZUKI SWIFT II (89-96)										
	1.0 i (SF310)		320339	08.92			13.0460-5985.2	605985	21333 15,0 +/WK	TOK
	1.3 (SF413)		320339	04.89						
	1.3 4WD (SF413)		320339	04.89						
	1.0 i (SF310)	320340			10.96		13.0460-5837.2	605837	23296 14,5 +/WK	BOS
	1.3 (SF413)	320340			10.96					
	1.3 4WD (SF413)	320340			10.96					
	1.0 i (SF310)			08.91	10.96		24.0117-0103.1	417103	231 17,0 15,0 V +B	
	1.3 (SF413)			04.89	10.96					
	1.3 4WD (SF413)			04.89	10.96					
	1.3 (SF413)			04.89	10.96 + 3 türig ¹⁾		24.3215-1704.3	020532	Rz 15,87	
	1.3 (SF413)			04.89	10.96 + 5 türig ²⁾					
	1.0 i (SF310)	320339		08.92	+ ABS/ + 4 türig ³⁾		24.3217-1725.3	020512	Rz 17,46	
	1.3 (SF413)	320339		04.89	+ ABS/ + 4 türig ³⁾		24.3217-1726.3	020513	Rz 17,46	
	1.3 (SF413)	320339		04.89	+ ABS/ + 4 türig ³⁾					
	1.0 i (SF310)			08.92	10.96 - ABS/ + 3 türig ⁴⁾		03.0137-0414.2	650414	180 x 27	
	1.0 i (SF310)			08.92	10.96 - ABS/ + 5 türig ⁵⁾					
	1.3 (SF413)			04.89	10.96 - ABS/ + 3 türig ⁴⁾					
	1.3 (SF413)			04.89	10.96 - ABS/ + 5 türig ⁵⁾					
	1.3 4WD (SF413)			08.92	10.96 - ABS/ + 3 türig ⁴⁾					
	1.3 4WD (SF413)			08.92	10.96 - ABS/ + 5 türig ⁵⁾					
	1.0 i (SF310)	320339		08.92	+ ABS/ + 4 türig ³⁾		03.0137-0315.2	650315	200 x 32	
	1.3 (SF413)	320339		04.89	+ ABS/ + 4 türig ³⁾		03.0137-9271.2	669271	Bremsbacken-Zubehör	
	1.3 4WD (SF413)	320339		04.89	+ ABS/ + 4 türig ³⁾					
	1.6 i 16V (SF416)			08.92	10.96					
	1.0 i (SF310)	320340			10.96 + ABS/ + 4 türig ³⁾		03.0137-0500.2	650500	200 x 32 HEB	BOS
	1.3 (SF413)	320340			10.96 + ABS/ + 4 türig ³⁾					
	1.3 4WD (SF413)	320340			10.96 + ABS/ + 4 türig ³⁾					
	1.0 i (SF310)			08.92	10.96 - ABS/ + 3 türig ⁴⁾		24.0218-0042.1	480164	180/182 x 36	
	1.0 i (SF310)			08.92	10.96 - ABS/ + 5 türig ⁵⁾					
	1.3 (SF413)			04.89	10.96 - ABS/ + 3 türig ⁴⁾					
	1.3 (SF413)			04.89	10.96 - ABS/ + 5 türig ⁵⁾					
	1.0 i (SF310)			08.92	10.96 + ABS/ + 3 türig ⁶⁾		24.0220-0040.1	480166	200/202 x 40	
	1.0 i (SF310)			08.92	10.96 + ABS/ + 4 türig ³⁾					
	1.0 i (SF310)			08.92	10.96 + ABS/ + 5 türig ⁷⁾					
	1.3 (SF413)			08.92	10.96 + ABS/ + 3 türig ⁶⁾					
	1.3 (SF413)			04.89	10.96 + ABS/ + 4 türig ³⁾					
	1.3 (SF413)			08.92	10.96 + ABS/ + 5 türig ⁷⁾					
	1.3 4WD (SF413)			04.89	10.96 + ABS					
	1.6 i 16V (SF416)			08.92	10.96					
	1.0 i (SF310)			08.92	10.96		24.3728-2003.2	592003	L=607	
	1.3 4WD (SF413)			04.89	07.92		24.3728-2201.2	592201	L=525	
TALBOT 1100 (68-81)										
	1.3 Spezial/TI			09.78	12.81		13.0441-4819.2	250104	Dichtungssatz	ATE
	0.9			01.73	12.81		13.0460-3010.2	603010	20009 15,0	ATE
	1.1			01.73	12.81					
	1.2			01.73	12.81					
	1.3 Spezial/TI			01.74	12.81		13.0460-4033.2	604033	20034 15,0	ATE
							13.0460-0038.2	610038	Belagsatz-Zubehör	ATE
	0.9			01.70	12.76		24.3219-1114.3	020323	Rz 19,05	BDX
	1.1			01.70	12.76					
	1.2			01.70	12.76					
	1.3 Spezial/TI			01.77	12.81		24.3220-1115.3	020312	Rz 20,64	BDX
							24.3220-0905.3	020207	Rz 20,64	LUC
	0.9			01.70	12.81		03.0137-0271.2	650271	229 x 42 HEB	LUC
	1.1			01.70	12.81		03.0137-9027.2	669027	Bremsbacken-Zubehör	LUC
	1.2			01.70	12.81					
	1.3 Spezial/TI			08.74	12.81		03.0137-0139.2	650139	229 x 42	BDX
							03.0137-0124.2	650124	229 x 42 HEB AUT	BDX
							03.0137-9020.2	669020	Bremsbacken-Zubehör	BDX
	0.9			10.76	12.81		24.2525-1601.3	040062	Nz 25,40	
	1.1			10.76	12.81					
	1.2			10.76	12.81					
	1.3 Spezial/TI			10.76	12.81					

¹⁾ + 3 door / + 3 porte / + 3 portes / + 3 puertas

²⁾ + 5 door / + 5 porte / + 5 portes / + 5 puertas

³⁾ + ABS/ + 4 door / + ABS/ + 4 porte / + ABS/ + 4 portes / + ABS/ + 4 puertas





























⁴⁾ - ABS/ + 3 door / - ABS/ + 3 porte / - ABS/ + 3 portes / - ABS/ + 3 puertas

































⁵⁾ - ABS/ + 5 door / - ABS/ + 5 porte / - ABS/ + 5 portes / - ABS/ + 5 puertas



























⁶⁾ + ABS/ + 3 door / + ABS/ + 3 porte / + ABS/ + 3 portes / + ABS/ + 3 puertas

⁷⁾ + ABS/ + 5 door / + ABS/ + 5 porte / + ABS/ + 5 portes / + ABS/ + 5 puertas

TALBOT 1301 (66-76)												
	1.3			09.66	12.76		13.0460-4033.2	604033			20034 15,0	ATE
							13.0460-0038.2	610038			Belagsatz-Zubehör	ATE
	1.3			09.66	12.76		03.0137-0139.2	650139			229 x 42	BDX
							03.0137-0124.2	650124			229 x 42 HEB AUT	BDX
							03.0137-9020.2	669020			Bremsbacken-Zubehör	BDX
TALBOT 1307 (75-80)												
	1.3			07.75	01.80		24.3220-1115.3	020312			Rz 20,64	BDX
	1.3 S			07.75	12.78		24.3220-0905.3	020207			Rz 20,64	LUC
	1.3			07.75	01.80		03.0137-0139.2	650139			229 x 42	BDX
	1.3 S			07.75	12.78		03.0137-0124.2	650124			229 x 42 HEB AUT	BDX
							03.0137-0271.2	650271			229 x 42 HEB	LUC
							03.0137-9020.2	669020			Bremsbacken-Zubehör	BDX
							03.0137-9027.2	669027			Bremsbacken-Zubehör	LUC
	1.3			07.75	01.80		24.2419-1601.3	030080			Gz 19,05	
	1.3 S			07.75	12.78							
	1.3			07.75	01.80		24.2525-1601.3	040062			Nz 25,40	
	1.3 S			07.75	12.78							
TALBOT 1308 (78-81)												
	1.4			11.78	08.81		24.3220-1115.3	020312			Rz 20,64	BDX
							24.3220-0905.3	020207			Rz 20,64	LUC
	1.4			11.78	08.81		03.0137-0139.2	650139			229 x 42	BDX
							03.0137-0124.2	650124			229 x 42 HEB AUT	BDX
							03.0137-0271.2	650271			229 x 42 HEB	LUC
							03.0137-9020.2	669020			Bremsbacken-Zubehör	BDX
							03.0137-9027.2	669027			Bremsbacken-Zubehör	LUC
	1.4			11.78	08.81		24.2419-1601.3	030080			Gz 19,05	
	1.4			11.78	08.81		24.2525-1601.3	040062			Nz 25,40	
TALBOT 1309 (78-80)												
	1.6			10.78	01.80		24.3220-1115.3	020312			Rz 20,64	BDX
							24.3220-0905.3	020207			Rz 20,64	LUC
	1.6			10.78	01.80		03.0137-0139.2	650139			229 x 42	BDX
							03.0137-0124.2	650124			229 x 42 HEB AUT	BDX
							03.0137-0271.2	650271			229 x 42 HEB	LUC
							03.0137-9020.2	669020			Bremsbacken-Zubehör	BDX
							03.0137-9027.2	669027			Bremsbacken-Zubehör	LUC
	1.6			10.78	01.80		24.2419-1601.3	030080			Gz 19,05	
	1.6			10.78	01.80		24.2525-1601.3	040062			Nz 25,40	
TALBOT 1501 (66-76)												
	1.5			09.66	12.76		13.0460-4033.2	604033			20034 15,0	ATE
							13.0460-0038.2	610038			Belagsatz-Zubehör	ATE
	1.5			09.66	12.76		03.0137-0139.2	650139			229 x 42	BDX
							03.0137-0124.2	650124			229 x 42 HEB AUT	BDX
							03.0137-9020.2	669020			Bremsbacken-Zubehör	BDX
TALBOT 1510/ALPINE (79-84)												
	1.4			09.80	04.84		11.0441-5402.2	250028			Dichtungssatz	ATE
	1.6			09.80	12.83		11.0101-5407.2	260011			Hülsensatz	ATE
							11.8171-0008.1	990049			Führungsbolzen	ATE
	1.4			08.79	04.84		24.3222-1708.3	020407			Rz 22,20	ATE
	1.6			08.79	12.83		24.3220-1115.3	020312			Rz 20,64	BDX
							24.3220-0905.3	020207			Rz 20,64	LUC
							24.3222-1118.3	020315			Rz 22,20	BDX
	1.4			08.79	04.84		03.0137-0139.2	650139			229 x 42	BDX
	1.6			08.79	12.83		03.0137-0124.2	650124			229 x 42 HEB AUT	BDX
							03.0137-0271.2	650271			229 x 42 HEB	LUC
							03.0137-9020.2	669020			Bremsbacken-Zubehör	BDX
							03.0137-9027.2	669027			Bremsbacken-Zubehör	LUC
	1.4			08.79	04.84		03.0520-3122.3	693122			22,20/229x42 TopKit	BDX
	1.6			08.79	12.83							
	1.4			08.79	04.84		24.2419-1601.3	030080			Gz 19,05	
	1.6			08.79	12.83							
	1.4			08.79	04.84		24.2525-1601.3	040062			Nz 25,40	
	1.6			08.79	12.83							



















		 kW																
TALBOT HORIZON (78-86)																		
	1.1 1.3 1.4 1.6 1.9 D			02.83 02.83 02.83 02.83	09.84 06.86 06.86 06.86			03.2120-2031.3 03.3517-0101.2	010106 390322					THz 20,64 Verschlusschraube			ATE	
	1.1 1.3 1.4 1.6 1.9 D			01.79 02.78 07.79 07.82 07.82	09.84 06.86 06.86 06.86 06.86			13.0441-4819.2	250104					Dichtungssatz			ATE	
	1.1 1.3 1.4 1.6 1.9 D			01.79 02.78 07.79 07.82 07.82	09.84 06.86 06.86 06.86 06.86			24.3220-1115.3 24.3220-0905.3	020312 020207					Rz 20,64 Rz 20,64			BDX LUC	
	1.1 1.3 1.4 1.6 1.9 D			01.79 02.78 07.79 07.82 07.82	09.84 06.86 06.86 06.86 06.86			03.0137-0139.2 03.0137-0124.2 03.0137-0271.2 03.0137-9020.2 03.0137-9027.2	650139 650124 650271 669020 669027					229 x 42 229 x 42 HEB AUT 229 x 42 HEB Bremsbacken-Zubehör Bremsbacken-Zubehör			BDX BDX LUC BDX LUC	
	1.1 1.3 1.4 1.6 1.9 D			01.79 02.78 07.79 07.82 07.82	09.84 06.86 06.86 06.86 06.86			24.2419-1601.3	030080					Gz 19,05				
	1.1 1.3 1.4 1.6			11.77 02.78 07.79 07.82	09.84 06.86 06.86 06.86			24.2525-1601.3	040062					Nz 25,40				
TALBOT MATRA BAGHEERA (74-80)																		
	1.3 1.4			01.74 12.75	01.78 01.78			13.0460-4035.2	604035					20173 15,0			ATE	
	1.3 1.4			01.74 12.75	03.78 09.80			13.0460-3961.2	603961					20336 14,0 +/WK			BDX	
	1.3 1.4			01.77 01.77	03.78 09.80			24.2525-1601.3	040062					Nz 25,40				
TALBOT MATRA MURENA (81-85)																		
	1.6 2.1			08.81 04.83	01.85 01.85			13.0460-3961.2	603961					20336 14,0 +/WK			BDX	
	1.6			08.81	01.85			24.2525-1601.3	040062					Nz 25,40				
TALBOT MATRA RANCHO (77-84)																		
	1.4			03.77	12.81			13.0441-4819.2	250104					Dichtungssatz			ATE	
	1.4			03.77	12.78			13.0460-4035.2	604035					20173 15,0			ATE	
	1.4			03.77	12.79			24.3220-1115.3 24.3220-0905.3	020312 020207					Rz 20,64 Rz 20,64			BDX LUC	
	1.4			01.80 03.77	06.84 06.84			24.3222-1118.3	020315					Rz 22,20			BDX	
	1.4			03.77	06.84			03.0137-0124.2 03.0137-0271.2 03.0137-9020.2 03.0137-9027.2	650124 650271 669020 669027					229 x 42 HEB AUT 229 x 42 HEB Bremsbacken-Zubehör Bremsbacken-Zubehör			BDX LUC BDX LUC	
	1.4			01.80	06.84			03.0520-3122.3	693122					22,20/229x42 TopKit			BDX	
	1.4			03.77	06.84			24.2525-1601.3	040062					Nz 25,40				
TALBOT SAMBA (81-86)																		
	0.9 1.1 1.2 Rallye 1.4 1.4 Cabrio 1.4 Rallye			01.81 01.81 01.83 01.81 01.81 01.83	12.85 06.86 10.86 10.86 06.86 10.86			24.2119-1503.3	010404					THz 19,05				
	0.9 1.1 1.2 Rallye 1.4 1.4 Cabrio 1.4 Rallye			01.81 01.81 01.83 01.81 01.81 01.83	09.83 09.83 09.83 09.83 09.83 09.83			13.0460-3928.2	603928					20140 14,0 +/WE			BDX	

								
TALBOT SAMBA (81-86)								
	0.9 1.1 1.2 Rallye 1.4 1.4 Cabrio 1.4 Rallye		01.81 01.81 01.83 01.81 01.81 01.83	12.85 06.86 10.86 10.86 06.86 10.86		24.3222-1102.3	020257	Rz 22,20 BDX
	0.9 1.1 1.2 Rallye 1.4 1.4 Cabrio 1.4 Rallye		01.81 01.81 01.83 01.81 01.81 01.83	12.85 06.86 10.86 10.86 06.86 10.86		03.0137-9032.2	669032	Bremsbacken-Zubehör BDX
	0.9 1.1 1.2 Rallye 1.4 1.4 Cabrio 1.4 Rallye		01.81 01.81 01.83 01.81 01.81 01.83	12.85 06.86 10.86 10.86 06.86 10.86		03.6043-0201.3	320026	BR S/3 (3) ATE
TALBOT SOLARA (80-86)								
	1.3 1.6		09.80 09.80	06.82 07.86		11.0441-5402.2 11.0101-5407.2 11.8171-0008.1	250028 260011 990049	Dichtungssatz ATE Hülzensatz ATE Führungsbolzen ATE
	1.3 1.6		02.80 02.80	06.82 07.86		24.3222-1708.3 24.3220-1115.3 24.3222-1118.3 24.3220-0905.3	020407 020312 020315 020207	Rz 22,20 ATE Rz 20,64 BDX Rz 22,20 BDX Rz 20,64 LUC
	1.3 1.6		02.80 02.80	06.82 07.86		03.0137-0139.2 03.0137-0124.2 03.0137-0271.2 03.0137-9020.2 03.0137-9027.2	650139 650124 650271 669020 669027	229 x 42 BDX 229 x 42 HEB AUT BDX 229 x 42 HEB LUC Bremsbacken-Zubehör BDX Bremsbacken-Zubehör LUC
	1.3 1.6		02.80 02.80	06.82 07.86		24.2419-1601.3	030080	Gz 19,05
	1.3 1.6		02.80 02.80	06.82 07.86		24.2525-1601.3	040062	Nz 25,40
TALBOT TAGORA (80-87)								
	2.1 2.3 TD 2.6		06.80 08.81 08.81	12.83 12.87 10.83		11.0441-5401.2	250027	Dichtungssatz ATE
	2.1 2.3 TD		06.80 08.81	12.83 12.87		24.0113-0128.1	413128	273 13,0 10,7
	2.1 2.3 TD		06.80 08.81	12.83 12.87		24.3220-1619.3	020246	Rz 20,64 LUC
	2.1 2.3 TD		06.80 08.81	12.83 12.87		03.0137-9082.2	669082	Bremsbacken-Zubehör LUC
	2.1 2.3 TD		06.80 08.81	12.83 12.87		03.6515-1000.3	320089	BRL 1/5 (3) ATE
TOYOTA 4-RUNNER (83-88)								
	2.0 (YN60) 2.4 D (LN60)		08.83 08.83	07.88 07.88		13.0460-5935.2	605935	20852 15,5 SUM
	2.0 (YN63) 2.4 D (LN61)		08.83 08.83	07.88 07.88		13.0460-5935.2 13.0460-0327.2	605935 610327	20852 15,5 SUM Belagsatz-Zubehör SUM
	2.0 (YN60) 2.4 D (LN60)		08.83 08.83	07.88 07.88		24.0113-0105.1	413105	302 12,5 11,5
	2.0 (YN63) 2.4 D (LN61)		08.85 08.85	07.88 07.88		24.0120-0168.1	420168	289 20,0 18,0 V
	2.0 (YN60) 2.4 D (LN60)		08.83 08.83	07.88 07.88		03.0137-0226.2	650226	254 x 58
TOYOTA 4-RUNNER (88-96)								
	3.0 (VZN130)		08.88	11.95		13.0460-5992.2	605992	21679 15,0 +WK
	3.0 (VZN130)		08.88	11.95		24.0120-0168.1	420168	289 20,0 18,0 V
	3.0 i V6 (VZN130) 3.0 TD (KZN130)	105 92	07.90 10.93	11.95 03.96		24.0125-0135.1	425135	291 25,0 23,0 V
	3.0 (VZN130)		08.88	11.95		03.0137-0308.2	650308	295 x 51
	3.0 (VZN130)		08.88	11.95		24.0229-5004.1	480312	295/297 x 67























TOYOTA CAMRY (82-86)								
	1.8 (SV10) 1.8 TD (CV10) 2.0 (SV11) 2.0 TD (CV11)	10.82 10.82 10.82 08.85	10.86 07.85 10.86 10.86	13.0460-5976.2 13.0460-0325.2	605976 610325		20870 15,0 Belagsatz-Zubehör	AKE AKE
	1.8 (SV10) 1.8 TD (CV10) 2.0 (SV11) 2.0 TD (CV11)	10.82 10.82 10.82 08.85	10.86 07.85 10.86 10.86	24.3219-1712.3	020388		Rz 19,05	
	1.8 (SV10) 1.8 TD (CV10) 2.0 (SV11) 2.0 TD (CV11)	10.82 10.82 10.82 08.85	10.86 07.85 10.86 10.86	03.0137-0313.2 03.0137-9114.2	650313 669114		200 x 37 Bremsbacken-Zubehör	
TOYOTA CAMRY (86-91)								
	1.8 (SV20) 2.0 i (SV21) 2.0 TD (CV20)	10.86 10.86 10.86	12.87 - ABS 12.87	13.0460-0333.2	610333		Belagsatz-Zubehör	SUM
	1.8 (SV20) 2.0 i (SV21) 2.0 i (SV21) 2.0 i 4WD (SV25) 2.0 i 4WD (SV25) 2.0 TD (CV20) 2.5 i V6 (VZV21)	01.88 01.88 08.88 10.87 08.88 01.88 02.88	07.88 - ABS 07.88 - ABS 11.88 11.88 11.88	13.0460-5938.2	605938		21158 15,5	AKE
	2.0 i (SV21) 2.0 i 4WD (SV25) 2.0 TD (CV20) 2.5 i V6 (VZV21)	12.88 12.88 12.88 12.88	08.89 08.89 08.89 08.89	13.0460-0333.2	610333		Belagsatz-Zubehör	SUM
	1.8 (SV20) 2.0 i (SV21) 2.0 TD (CV20)	10.86 10.86 10.86	12.87 - ABS 12.87	24.0122-0154.1	422154		255 22,0 21,0 V	
	2.0 i (SV21) 2.5 i V6 (VZV21)	10.86 02.88	05.91 05.91	24.0110-0241.1	410241		269 10,0 9,0	
	1.8 (SV20) 2.0 i (SV21) 2.0 TD (CV20)	10.86 10.86 10.86	07.88 + Limousine 1) 05.91 + Limousine 1) 05.91 + Limousine 1)	24.3219-1712.3	020388		Rz 19,05	
	1.8 (SV20) 2.0 i (SV21) 2.0 TD (CV20)	10.86 10.86 10.86	07.88 + Limousine 1) 05.91 + Limousine 1) 05.91 + Limousine 1)	03.0137-0313.2 03.0137-9114.2	650313 669114		200 x 37 Bremsbacken-Zubehör	
TOYOTA CAMRY (91-96)								
	2.2 i (SXV10) 2.2 i (SXV10) 3.0 i V6 (VCV10)	06.91 08.93 06.91	07.93 08.96 08.96	24.0128-0114.1 24.0128-0115.1	428114 428115		255 28,0 26,0 V 275 28,0 26,0 V +B	
	2.2 i (SXV10) 3.0 i V6 (VCV10)	06.91 06.91	08.96 + ABS 08.96	13.0460-5835.2	605835		20076 15,5 +WK	AKE
	2.2 i (SXV10)	06.91	08.96 + ABS	24.0110-0700.1	410700		269 10,0 9,0	
	2.2 i (SXV10)	06.91	08.96 - ABS	03.0137-0318.2	650318		229 x 41	
TOYOTA CARINA II (83-87)								
	1.6 (AT151) 1.8 (ST150) 2.0 D (CT150)	10.83 10.83 10.83	11.87 - Europa 2) 11.87 - Europa 2) 11.87 - Europa 2)	24.3219-1712.3	020388		Rz 19,05	
	1.6 (AT151) 1.8 (ST150) 2.0 D (CT150)	10.83 10.83 10.83	11.87 11.87 11.87	03.0137-0313.2 03.0137-9114.2	650313 669114		200 x 37 Bremsbacken-Zubehör	
TOYOTA CARINA II (87-92)								
	1.6 (AT171) 2.0 (ST171) 2.0 D (CT170)	12.87 12.87 12.87	01.92 + 13" Rad 3) 01.92 + 13" Rad 3) 01.92	13.0460-5976.2 13.0460-0325.2	605976 610325		20870 15,0 Belagsatz-Zubehör	AKE AKE
	1.6 (AT171) 2.0 (ST171)	12.87 12.87	01.92 + 14" Rad 4) 01.92 + 14" Rad 4)	13.0460-0333.2	610333		Belagsatz-Zubehör	SUM
	1.6 (AT171) 2.0 (ST171) 2.0 D (CT170)	12.87 12.87 12.87	01.92 + 13" Rad 3) 01.92 + 13" Rad 3) 01.92	24.0122-0153.1	422153		238 22,0 21,0 V	
	1.6 (AT171) 2.0 (ST171)	12.87 12.87	01.92 + 14" Rad 4) 01.92 + 14" Rad 4)	24.0122-0154.1	422154		255 22,0 21,0 V	
	2.0 (ST171)	12.87	01.92	24.0110-0241.1	410241		269 10,0 9,0	
	1.6 (AT171) 2.0 (ST171) 2.0 D (CT170)	12.87 12.87 12.87	01.92 01.92 01.92	24.3219-1712.3	020388		Rz 19,05	

1) + Saloon / + Berlina / + Berline / + Berlina
2) - Europe / - Europa / - Europe / - Europa
3) + 13" wheel / + ruota 13" / + roue 13" / + rueda 13"
4) + 14" wheel / + ruota 14" / + roue 14" / + rueda 14"



















TOYOTA CARINA II (87-92)											
	1.6 (AT171) 2.0 (ST171) 2.0 D (CT170)			12.87 12.87 12.87	01.92 01.92 01.92	03.0137-0313.2 03.0137-9114.2	650313 669114				200 x 37 Bremsbacken-Zubehör
TOYOTA CELICA (85-89)											
	1.6 (AT160) 1.6 i (AT160) 2.0 i (ST162) 2.0 i (ST162) 2.0 i (ST162)			08.85 08.85 08.85 08.85 12.88	09.89 09.89 09.89 11.88 09.89	13.0460-5976.2 13.0460-0325.2	605976 610325				20870 15,0 Belagsatz-Zubehör AKE AKE
	2.0 i (ST162)			08.85	11.88 + ABS	13.0460-5938.2	605938				21158 15,5 AKE
	2.0 i (ST162)			08.85	09.89 + ABS	13.0460-0333.2	610333				Belagsatz-Zubehör SUM
	2.0 i (ST162)			08.85	09.89	24.0110-0241.1	410241				269 10,0 9,0
	1.6 (AT160) 1.6 i (AT160)			08.85 08.85	09.89 09.89	24.3219-1712.3	020388	<input type="checkbox"/>			Rz 19,05
	1.6 (AT160) 1.6 i (AT160)			08.85 08.85	09.89 09.89	03.0137-0313.2 03.0137-9114.2	650313 669114				200 x 37 Bremsbacken-Zubehör
TOYOTA CELICA (89-93)											
	1.6 i (AT180)	77		10.89	11.93	13.0460-5976.2 13.0460-0325.2	605976 610325				20870 15,0 Belagsatz-Zubehör AKE AKE
	2.0 i (ST182) 2.0 Turbo 4x4 (ST185)	115		10.89 10.89	11.93 11.93	13.0460-0333.2	610333				Belagsatz-Zubehör SUM
	1.6 i (AT180) 2.0 i (ST182) 2.0 Turbo 4x4 (ST185)	77 115		08.91 10.89	11.93 11.93	24.0122-0178.1	422178				255 22,0 20,0 V
	2.0 i (ST182)	115		10.89	11.93	24.0125-0144.1	425144				277 25,0 23,0 V
	2.0 i (ST182)	115		10.89	11.93	24.0110-0241.1	410241				269 10,0 9,0
	1.6 i (AT180)	77		10.89	11.93	24.3219-1712.3	020388	<input type="checkbox"/>			Rz 19,05
	1.6 i (AT180)	77		10.89	11.93	03.0137-0313.2 03.0137-9114.2	650313 669114				200 x 37 Bremsbacken-Zubehör
TOYOTA COROLLA (83-87)											
	1.3 (AE80) 1.3 (EE80) 1.6 (AE82) 1.8 D (CE80)			05.83 05.83 05.83 05.83	04.87 04.87 04.87 04.87	13.0460-5976.2 13.0460-0325.2	605976 610325				20870 15,0 Belagsatz-Zubehör AKE AKE
	1.6 GT (AE82)			05.83	04.87	24.0109-0128.1	409128				242 9,0 8,0
	1.3 (AE80) 1.3 (EE80) 1.6 (AE82) 1.8 D (CE80)			05.83 05.83 05.83 05.83	04.87 04.87 04.87 04.87	03.0137-9114.2	669114				Bremsbacken-Zubehör
TOYOTA COROLLA (87-92)											
	1.3 (EE90) 1.6 (AE92) 1.6 4WD (AE95) 1.8 D (CE90)			05.87 05.87 05.87 05.87	05.92 05.92 05.92 05.92	13.0460-5976.2 13.0460-0325.2	605976 610325				20870 15,0 Belagsatz-Zubehör AKE AKE
	1.3 (EE90) 1.6 (AE92) 1.6 4WD (AE95) 1.8 D (CE90)			09.89 05.87 05.87 05.87	05.92 05.92 05.92 05.92	24.0118-0110.1	418110				238 18,0 17,0 V
	1.6 GTi (AE92)			05.87	05.92	24.0122-0188.1	422188				258 22,0 21,0 V
	1.6 GTi (AE92)			05.87	05.92 - ABS	24.0109-0128.1	409128				242 9,0 8,0
	1.6 GTi (AE92)			05.87	05.92 + ABS	24.0109-0128.1	409128				242 9,0 8,0
	1.3 (EE90) 1.6 (AE92) 1.8 D (CE90)			05.87 05.87 05.87	05.92 + Limousine ¹⁾ 05.92 + Limousine ¹⁾ 05.92 + Limousine ¹⁾	03.0137-0221.2 03.0137-9114.2	650221 669114				200 x 37/30 Bremsbacken-Zubehör
	1.3 (EE90) 1.6 (AE92) 1.8 D (CE90)			05.87 05.87 05.87	05.92 + Kombiwagen ²⁾ 05.92 + Kombiwagen ²⁾ 05.92 + Kombiwagen ²⁾	03.0137-0313.2 03.0137-9114.2	650313 669114				200 x 37 Bremsbacken-Zubehör
	1.3 (EE90) 1.6 (AE92) 1.8 D (CE90)			09.89 05.87 05.87	05.92 05.92 05.92	24.3727-1902.2	581902	<input type="checkbox"/>			L=1560
TOYOTA CORONA (82-87)											
	1.6 (AT151) 1.8 (ST150) 2.0 (ST151) 2.0 D (CT150)			10.83 10.83 10.83 10.83	11.87 11.87 11.87 11.87	13.0460-5976.2 13.0460-0325.2	605976 610325				20870 15,0 Belagsatz-Zubehör AKE AKE

¹⁾ + Saloon / + Berlina / + Berline / + Berlina
²⁾ + Estate / + Station Wagon / + Break / + Break

								
TOYOTA CORONA (82-87)								
	1.6 (AT151) 1.8 (ST150) 2.0 (ST151) 2.0 D (CT150)		10.83 10.83 10.83 10.83	11.87 11.87 11.87 11.87		03.0137-0313.2 03.0137-9114.2	650313 669114	200 x 37 Bremsbacken-Zubehör
TOYOTA CROWN (74-79)								
	2.0 (RS80) 2.6 (MS83) 2.6 (MS85) 2.6 (MS88) 2.6 (MS95)		10.74 10.74 10.74 10.74 10.74	08.79 08.79 08.79 08.79 08.79	- Royal Saloon Typ 1)	03.0137-9203.2	669203	Bremsbacken-Zubehör
TOYOTA CROWN (79-83)								
	2.0 (RS110) 2.2 D (LS110) 2.6 (MS111) 2.8 (MS112)		09.79 09.79 09.79 09.79	07.83 07.83 07.83 07.83		03.0137-9203.2	669203	Bremsbacken-Zubehör
TOYOTA CROWN (83-87)								
	2.0 (YS120) 2.4 D (LS120) 2.8 (MS122)		08.83 08.83 08.83	09.87 09.87 09.87		03.0137-9203.2	669203	Bremsbacken-Zubehör
TOYOTA HIACE (77-82)								
	1.6 (RH11) 1.6 (RH20/30) 2.0 (RH22/25/32/42) 2.2 D (LH11/20/30)		02.77 02.77 02.77 02.77	11.82 11.82 11.82 11.82	+ Scheibenbremse 2) + Scheibenbremse 2) + Scheibenbremse 2) + Scheibenbremse 2)	03.0137-0226.2	650226	254 x 58
TOYOTA HIACE (Pickup) (83-85)								
	1.6 (RH11) 2.2 D (LH11)		12.82 12.82	07.85 07.85		03.0137-0226.2	650226	254 x 58
TOYOTA HIACE (Bus) (83-87)								
	1.8 (YH50/60) 2.0 (YH51/61) 2.0 (YH71) 2.2 (YH53) 2.2 (YH63) 2.2 (YH73) 2.2 D (LH50/60) 2.2 D (LH70) 2.4 D (LH51/61) 2.4 D (LH71)		12.82 12.82 12.82 12.82 12.82 12.82 12.82 12.82 12.82 12.82	08.87 08.87 08.87 08.87 08.87 08.87 08.87 08.87 08.87 08.87		13.0460-5938.2	605938	21158 15,5 AKE
	1.8 (YH50/60) 2.0 (YH51/61) 2.0 (YH71) 2.2 (YH53) 2.2 (YH63) 2.2 (YH73) 2.2 D (LH50/60) 2.2 D (LH70) 2.4 D (LH51/61) 2.4 D (LH71)		12.82 12.82 12.82 12.82 12.82 12.82 12.82 12.82 12.82 12.82	08.87 08.87 08.87 08.87 08.87 08.87 08.87 08.87 08.87 08.87		24.0125-0118.1	425118	257 25,0 23,0 V
	1.8 (YH50/60) 2.0 (YH51/61) 2.0 (YH71) 2.2 (YH53) 2.2 (YH63) 2.2 (YH73) 2.2 D (LH50/60) 2.2 D (LH70) 2.4 D (LH51/61) 2.4 D (LH71)		12.82 12.82 12.82 12.82 12.82 12.82 12.82 12.82 12.82 12.82	08.87 08.87 08.87 08.87 08.87 08.87 08.87 08.87 08.87 08.87		03.0137-0226.2	650226	254 x 58
	2.2 4WD (YH56) 2.2 4WD (YH66) 2.4 D 4WD (LH56/66)		08.86 08.86 08.86	08.87 08.87 08.87		03.0137-0308.2	650308	295 x 51
TOYOTA HIACE (87-89)								
	2.0 (YH51) 2.0 (YH61) 2.4 D (LH51) 2.4 D (LH61)		09.87 09.87 09.87 09.87	11.89 11.89 11.89 11.89		13.0460-5938.2	605938	21158 15,5 AKE
	2.0 (YH51) 2.0 (YH61) 2.4 D (LH51) 2.4 D (LH61)		09.87 09.87 09.87 09.87	11.89 11.89 11.89 11.89		24.0125-0118.1	425118	257 25,0 23,0 V
	2.0 (YH51) 2.0 (YH61) 2.4 D (LH51) 2.4 D (LH61)		09.87 09.87 09.87 09.87	08.88 08.88 08.88 08.88	- (OK) - (S) - (OK) - (OK)	03.0137-0226.2	650226	254 x 58
	2.0 (YH51) 2.0 (YH51) 2.0 (YH61) 2.0 (YH61)		09.87 09.88 09.87 09.88	02.88 11.89 02.88 11.89	+ (OK) + (S) 	03.0137-0193.2 03.0137-9115.2	650193 669115	254 x 52 Bremsbacken-Zubehör

1) - type Royal Saloon / - tipo Royal berlina / - type Royal Saloon / - tipo Royal Saloon

































2) + disc brake / + disco freno / + disques de frein / + disco de freno













        												
TOYOTA HIACE (87-89)												
	2.4 D (LH51)			09.87	02.88	+ OK	03.0137-0193.2	650193			254 x 52 Bremsbacken-Zubehör	
	2.4 D (LH51)			09.88	11.89		03.0137-9115.2	669115				
	2.4 D (LH61)			09.87	02.88	+ OK						
	2.4 D (LH61)			09.88	11.89							
	2.2 4WD (YH56)			09.87	11.89		03.0137-0308.2	650308				295 x 51
2.2 4WD (YH66)			09.87	11.89								
2.4 D 4WD (LH56/66)			09.87	11.89								
TOYOTA HIACE (89-95)												
	2.0 (RZH 102)	74		02.90	08.95		13.0460-5892.2	605892			21689 15,5	
	2.4 (RZH 103)	88		08.89	08.95							
	2.4 D			08.89	08.95							
	2.4 4WD			08.89	08.95		13.0460-5722.2	605722			21468 15,5	
TOYOTA HILUX (78-83)												
	2.0 4WD (RN36)			08.78	07.83		13.0460-5935.2	605935			20852 15,5	SUM
	2.0 4WD (RN46)			08.78	07.83		13.0460-0327.2	610327			Belagsatz-Zubehör	SUM
	2.2 D 4WD (LN36)			08.78	07.83							
	2.2 D 4WD (LN46)			08.78	07.83							
	2.0 4WD (RN36)			08.78	07.83		24.0113-0105.1	413105			302 12,5 11,5	
	2.0 4WD (RN46)			08.78	07.83							
	2.2 D 4WD (LN36)			08.78	07.83							
	2.2 D 4WD (LN46)			08.78	07.83							
	1.6 (RN30)			08.78	07.83	+ Scheibenbremse ¹⁾	03.0137-0226.2	650226			254 x 58	
	1.6 (RN40)			08.78	07.83	+ Scheibenbremse ¹⁾						
	2.0 (RN31)			08.78	07.83	+ Scheibenbremse ¹⁾						
	2.0 (RN41)			08.78	07.83	+ Scheibenbremse ¹⁾						
	2.0 4WD (RN36)			08.78	07.83							
	2.0 4WD (RN46)			08.78	07.83							
	2.2 D (LN30)			08.78	07.83	+ Scheibenbremse ¹⁾						
2.2 D (LN40)			08.78	07.83	+ Scheibenbremse ¹⁾							
2.2 D 4WD (LN36)			08.78	07.83								
2.2 D 4WD (LN46)			08.78	07.83								
TOYOTA HILUX (83-88)												
	1.6 (YN50)			08.83	07.88		13.0460-5938.2	605938			21158 15,5	AKE
	1.6 (YN55)			08.83	07.88							
	2.0 (YN52/57/58)			08.83	07.88							
	2.2 D (LN50)			08.83	07.88							
	2.2 D (LN55)			08.83	07.88							
	2.4 (RN50)			08.83	07.88							
	2.4 D (LN51)			08.83	07.88							
	2.4 D (LN56)			08.83	07.88							
	2.0 4WD (YN60)			08.83	07.88		13.0460-5935.2	605935			20852 15,5	SUM
	2.0 4WD (YN62)			08.83	07.88							
2.0 4WD (YN65)			08.83	07.88								
2.0 4WD (YN67)			08.83	07.88								
2.4 D 4WD (LN60)			08.83	07.88								
2.4 D 4WD (LN65)			08.83	07.88								
	2.0 4WD (YN60)			08.83	07.88		24.0113-0105.1	413105			302 12,5 11,5	
	2.0 4WD (YN62)			08.83	07.88							
	2.0 4WD (YN65)			08.83	07.88							
	2.0 4WD (YN67)			08.83	07.88							
	2.4 D 4WD (LN60)			08.83	07.88							
	2.4 D 4WD (LN65)			08.83	07.88							
	1.6 (YN50)			08.83	07.88	+ Scheibenbremse ¹⁾	03.0137-0226.2	650226			254 x 58	
1.6 (YN55)			08.83	07.88	+ Scheibenbremse ¹⁾							
2.0 (YN52/57/58)			08.83	07.88	+ Scheibenbremse ¹⁾							
2.0 4WD (YN60)			08.83	07.88								
2.0 4WD (YN62)			08.83	07.88								
2.0 4WD (YN65)			08.83	07.88								
2.0 4WD (YN67)			08.83	07.88								
2.2 D (LN50)			08.83	07.88	+ Scheibenbremse ¹⁾							
2.2 D (LN55)			08.83	07.88	+ Scheibenbremse ¹⁾							
2.4 (RN50)			08.83	07.88								
2.4 D (LN51)			08.83	07.88	+ Scheibenbremse ¹⁾							
2.4 D (LN56)			08.83	07.88	+ Scheibenbremse ¹⁾							
2.4 D 4WD (LN60)			08.83	07.88								
2.4 D 4WD (LN65)			08.83	07.88								
TOYOTA LAND CRUISER 40-47 (80-86)												
	3.0 D (BJ40/43)			08.80	04.86		13.0460-5935.2	605935			20852 15,5	SUM
	3.4 D (BJ42/46)			08.80	04.86		13.0460-0327.2	610327			Belagsatz-Zubehör	SUM
	3.4 D (BJ45)			08.80	04.86							
	4.0 D (HJ47)			08.80	04.86							
	4.3 (FJ40/43)			08.80	04.86							
	4.3 (FJ45)			08.80	04.86							
	3.0 D (BJ40/43)			08.80	04.86		24.0120-0153.1	420153			302 20,0 19,0 V	
	3.4 D (BJ42/46)			08.80	04.86							
	3.4 D (BJ45)			08.80	04.86							
	4.0 D (HJ47)			08.80	04.86							
	4.3 (FJ40/43)			08.80	04.86							
	4.3 (FJ45)			08.80	04.86							

¹⁾ + disc brake / + disco freno / + disques de frein / + disco de freno

KW			
TOYOTA LAND CRUISER 40-55 (69-80)																
	3.0 D (BJ40/43)			09.79	07.80	13.0460-5935.2	605935					20852	15,5	SUM		
	3.9 (FJ40/42/43/55)			09.79	07.80	13.0460-0327.2	610327							Belagsatz-Zubehör	SUM	
	4.3 (FJ40/43/55)			09.79	07.80											
	3.0 D (BJ40/43)			09.79	07.80	24.0120-0153.1	420153					302	20,0	19,0	V	
	3.9 (FJ40/42/43/55)			09.79	07.80											
	4.3 (FJ40/43/55)			09.79	07.80											
TOYOTA LAND CRUISER 70-75 (84-89)																
	2.4 (RJ70)			11.84	12.89	13.0460-5935.2	605935					20852	15,5	SUM		
	2.4 D (LJ70)			11.84	12.89											
	2.4 TD (LJ70)			11.84	12.89											
	3.4 D (BJ70/75)			11.84	12.89	13.0460-5935.2	605935					20852	15,5	SUM		
	3.4 TD (BJ71)			10.85	12.89	13.0460-0327.2	610327							Belagsatz-Zubehör	SUM	
	2.4 (RJ70)			11.84	12.89	24.0113-0105.1	413105					302	12,5	11,5		
	2.4 D (LJ70)			11.84	12.89											
	2.4 TD (LJ70)			11.84	12.89											
	3.4 D (BJ70/75)			11.84	12.89	24.0120-0153.1	420153					302	20,0	19,0	V	
	3.4 TD (BJ71)			10.85	12.89											
	2.4 (RJ70)			11.84	12.89	03.0137-0193.2	650193					254	x 52		Bremsbacken-Zubehör	
	2.4 D (LJ70)			11.84	12.89	03.0137-9115.2	669115									
	2.4 TD (LJ70)			11.84	12.89											
	TOYOTA LAND CRUISER 70-75 (90-96)															
		2.4 (RJ70/73)			01.90	12.96	13.0460-5992.2	605992					21679	15,0	+WK	
		2.4 TD (LJ70/73)			01.90	05.96										
3.0 TD (KZJ70/73/77)				05.93	05.96											
3.4 D (BJ73)				01.90	12.96											
3.5 D (PZJ70)				01.90	12.96											
4.2 TD (HZJ70/73)				01.90	12.96											
	2.4 (RJ70/73)			01.90	12.96	13.0460-5893.2	605893					21777	14,7	+WK		
	2.4 TD (LJ70/73)			01.90	05.96											
	2.4 (RJ70/73)			01.90	12.96	24.0120-0153.1	420153					302	20,0	19,0	V	
	2.4 TD (LJ70/73)			01.90	05.96											
	3.0 TD (KZJ70/73/77)			05.93	05.96											
	3.4 D (BJ73)			01.90	12.96											
	3.5 D (PZJ70)			01.90	12.96											
	4.2 TD (HZJ70/73)			01.90	12.96											
	2.4 (RJ70/73)			01.90	12.96	24.0113-0105.1	413105					302	12,5	11,5		
	2.4 TD (LJ70/73)			01.90	05.96											
	2.4 (RJ70/73)			01.90	12.96	13.0460-5744.2	605744					21947	15,4			
	2.4 TD (LJ70/73)			01.90	05.96											
	4.2 TD (HZJ70/73)			01.90	12.96											
	2.4 (RJ70/73)			01.90	04.93	03.0137-0193.2	650193					254	x 52		Bremsbacken-Zubehör	
	2.4 TD (LJ70/73)			01.90	04.93	03.0137-9115.2	669115									
	2.4 (RJ70/73)			05.93	12.96	03.0137-0308.2	650308					295	x 51			
	2.4 TD (LJ70/73)			05.93	05.96											
	TOYOTA LAND CRUISER STATION WAGON 60-62 (80-89)															
	3.4 D (BJ60)			08.80	08.87	13.0460-5935.2	605935					20852	15,5	SUM		
	4.0 D (HJ60)			08.80	12.89	13.0460-0327.2	610327							Belagsatz-Zubehör	SUM	
	4.0 TD (HJ61)			10.85	12.89											
	4.2 (FJ60)			08.80	08.87											
	4.2 (FJ62)			08.80	12.89											
	3.4 D (BJ60)			08.80	08.87	24.0120-0153.1	420153					302	20,0	19,0	V	
	4.0 D (HJ60)			08.80	12.89											
	4.0 TD (HJ61)			10.85	12.89											
	4.2 (FJ60)			08.80	08.87											
	4.2 (FJ62)			08.80	12.89											
TOYOTA MODEL-F (82-88)																
	1.8 (YR20)			11.82	08.84	03.0137-9203.2	669203								Bremsbacken-Zubehör	
	2.0 (YR21)			11.82	07.88											
	2.0 (YR22)			11.82	07.88											
	2.0 4WD (YR31)			01.86	07.88											
	2.0 D (CR21)			11.82	07.88											
	TOYOTA MODEL-F (88-90)															
	2.0 (YR21/22)			08.88	01.90	03.0137-9203.2	669203								Bremsbacken-Zubehör	
	2.0 4WD (YR31)			08.88	01.90											
TOYOTA MR2 (84-89)																
	1.6 i 16V (AW11)			11.84	12.89	13.0460-5976.2	605976					20870	15,0	AKE		
						13.0460-0325.2	610325							Belagsatz-Zubehör	AKE	
TOYOTA PASEO (91-95)																
	1.5 i 16V (EL44)	85		04.91	07.95	13.0460-5976.2	605976					20870	15,0	AKE		
						13.0460-0325.2	610325							Belagsatz-Zubehör	AKE	
	1.5 i 16V (EL44)	85		04.91	07.95	03.0137-0257.2	650257					180	x 28		Bremsbacken-Zubehör	
						03.0137-9114.2	669114									

1) + RA disc brake / + P disco freno / + frein à disque essieu AR / + ET-disco de freno
2) + RA drum brake / + P freno a tamburo / + frein à tambour essieu AR / + ET-tambores de freno
3) + ABS / + Europe / + ABS / + Europa / + ABS / + Europe / + ABS / + Europa





















									
TOYOTA STARLET (84-89)									
	1.0 (EP70) 1.3 (EP71) 1.5 D (NP70)	40 55 40		10.84 10.84 12.86	12.89 12.89 12.89	03.0137-9080.2	669080	Bremsbacken-Zubehör	
TOYOTA STARLET (89-96)									
	1.0 (EP80) 1.3 (EP81) 1.5 D (NP80)	40 55 40		12.89 12.89 12.89	03.96 - ABS 03.96 - ABS 03.96	13.0460-5969.2	605969	21948 13,5 + SUM	
	1.0 (EP80) 1.3 (EP81)	40 55		12.89 12.89	11.90 + ABS 11.90 + ABS	13.0460-5976.2 13.0460-0325.2	605976 610325	20870 15,0 AKE Belagsatz-Zubehör AKE	
	1.0 (EP80) 1.3 (EP81)	40 55		01.92 01.92	03.96 + ABS 03.96 + ABS	24.0118-0124.1	418124	238 18,0 17,0 V +B	
	1.0 (EP80) 1.3 (EP81) 1.5 D (NP80)	40 55 40		12.89 12.89 12.89	03.96 03.96 03.96	03.0137-0257.2 03.0137-9080.2	650257 669080	180 x 28 Bremsbacken-Zubehör	
TOYOTA SUPRA (86-93)									
	3.0 i 24V (MA70) 3.0 i Turbo (MA70)	150		01.86 08.87	04.93 04.93	24.0118-0119.1	418119	291 18,0 17,0 V	
TOYOTA TERCEL (82-88)									
	1.3 (AL20) 1.5 (AL21) 1.5 4WD (AL25)	48 52		05.82 05.82 08.82	08.84 08.84 01.88	13.0460-5976.2 13.0460-0325.2	605976 610325	20870 15,0 AKE Belagsatz-Zubehör AKE	
	1.3 (AL20) 1.5 (AL21)	48 52		05.82 05.82	08.84 08.84	03.0137-9080.2	669080	Bremsbacken-Zubehör	
TRABANT 1,1 (90-91)									
	1.1			05.90	05.91	03.0137-0228.2	650228	200 x 30	
TRABANT 601 (65-90)									
	alle Typen			01.65	04.90	24.2722-1202.3 24.2722-1201.3	020144 020143	2  2 	Rz 22,20 Rz 22,20
	alle Typen			01.65	04.90	03.0137-0227.2	650227	200 x 30	
	alle Typen			01.65	04.90	24.5110-0155.3	330040	2	L=155
	alle Typen			01.65	04.90	24.3215-1201.3	020160		Rz 15,87
	alle Typen			01.65	04.90	03.0137-0228.2	650228		200 x 30
VOLKSWAGEN 411/412 (Typ 4) (68-75)									
	1.7 1.8			07.68 07.73	12.73 03.75	03.3222-5011.3	020462		Rz 22,20
VOLKSWAGEN 1500/1600 (TYP 3) (61-75)									
	1500 A Limousine 1500 Variant 1600 1600			08.65 01.66 08.65 08.67	07.67 12.67 07.67 12.73	03.3119-6457.3	010269		Hz 19,05 ATE
	1500 1500 1600	3112268739		01.66 08.65	12.67 12.73	03.2119-6713.3 13.0441-4204.2 13.0441-4209.2	010061 250085 250088		Thz 19,05 ATE Dichtungssatz ATE Dichtungssatz ATE
	1500 1600 1600			01.66 08.65 08.71	12.67 07.71 12.73	13.0460-3010.2 13.0460-0014.2 13.0460-4033.2 13.0460-0029.2	603010 610014 604033 610029		20009 15,0 ATE Belagsatz-Zubehör ATE 20034 15,0 ATE Belagsatz-Zubehör ATE
	1500 1600			01.66 08.65	12.67 07.71	24.0110-0142.1	410142		278 9,5 8,0
	1500 Limousine 1500 Variant			01.61 01.61	12.73 12.65	24.5171-0393.3	331311	2	L=393
	1500 A 1500 Variant 1600 Limousine 1600 Variant			01.66 01.66 08.65 08.65	12.67 12.67 07.68 07.67	24.5165-0350.3	331257	2	L=350
	1600 Limousine 1600 Variant			08.68 08.67	12.73 12.73	83.6101-0325.3	330206	2	L=325

VOLKSWAGEN 1500/1600 (TYP 3) (61-75)									
									
1500				01.61	12.73	24.5224-0240.3	331260	2	L=240
1600 Limousine				08.65	07.68				
1600 Variant				08.65	07.67				
1600 Limousine				08.68	12.73	83.6101-0250.3	330203		L=250
1600 Variant				08.67	07.71				
1600 Variant				08.71	12.73	24.5224-0240.3	331260	2	L=240
1500 Variant				08.64	12.65	03.3223-0611.3	020091		Rz 23,81
1500 Limousine	221975				12.73	03.3222-5011.3	020462		Rz 22,20
1500 Variant				01.66	12.67				
1600				08.65	12.73				
VOLKSWAGEN CADDY I (83-92)									
				08.82	07.83	03.2120-1531.3	010092		THz 20,64
1.6			14-M-010000	08.83		03.2120-1491.3	010089		THz 20,64 + WE
1.6 D			14-M-010000	08.82					
1.8			14-M-010000	08.85					
1.6	◀	14-N-000001			07.92	03.2120-3943.3	010532		THz 20,64
1.6 D	◀	14-N-000001			07.92				
1.8	◀	14-N-000001			07.92				
1.6	▶	14-N-000001			07.92	03.2120-1531.3	010092		THz 20,64
1.6 D	▶	14-N-000001			07.92				
1.8	▶	14-N-000001			07.92				
1.5			14-D-010000	08.82		11.0441-4808.2	250022	f.Vornr -8007/8008 -8503/8504 ¹⁾	Dichtungssatz
1.6			14-D-010000	08.83		11.0441-4804.2	250019		Dichts. (+Sich. Ring)
1.6 D			14-D-010000	08.82		11.0101-4801.2	260006		Hülzensatz
						24.0102-4801.2	260085		Hülzensatz+Schrauben
1.6		14-E-010001			07.92	11.0441-4808.2	250022		Dichtungssatz
1.6 D		14-E-010001			07.92	11.0101-4801.2	260006		Hülzensatz
1.8				08.85	07.92	24.0102-4801.2	260085		Hülzensatz+Schrauben
1.5				08.82	07.83	13.0460-7032.2	607032		20887 19,7 +/Zub
1.6				08.83	07.92				
1.6 D				08.82	07.92				
1.8				08.85	07.92				
1.5				08.82	07.83	24.0112-0106.1	412106		239 12,0 10,0 +S +B
1.6				08.83	07.92	24.0312-0106.1	512106		239 12,0 10,0 +S +B PD
1.6 D				08.82	07.92				
1.8				08.85	07.92				
1.5				08.82	07.83	24.5170-0315.3	331309	2	L=315
1.6				08.83	07.92				
1.6 D				08.82	07.92				
1.8				08.85	07.92				
1.5				08.82	07.83	83.6299-0807.3	330901	2	L=430/430
1.6				08.83	07.92				
1.6 D				08.82	07.92				
1.8				08.85	07.92				
1.5				08.82	07.83	03.3217-2112.3	020027	+ GG ²⁾	Rz 17,46
1.6			14-H-011048	08.83		24.3217-0908.3	020167	+ ALU ³⁾	Rz 17,46
1.6 D			14-H-011048	08.82					
1.8			14-H-011048	08.85					
1.6		14-H-011049			07.92	24.3219-0909.3	020188		Rz 19,05
1.6 D		14-H-011049			07.92				
1.8		14-H-011049			07.92				
1.5				08.82	07.83	03.0137-0264.2	650264		230 x 40 HEB
1.6			14-M-006000	08.83		03.0137-9044.2	669044		Bremsbacken-Zubehör
1.6 D			14-M-006000	08.82					
1.8			14-M-006000	08.85					
1.6		14-M-006001			07.92	03.0137-0264.2	650264		230 x 40 HEB
1.6 D		14-M-006001			07.92	03.0137-9164.2	669164		Bremsbacken-Zubehör
1.8		14-M-006001			07.92				
1.5				08.82	07.83	03.0420-1217.3	681217		17,46/230x40 Kit
1.6			14-H-011048	08.83					
1.6 D			14-H-011048	08.82					
1.8			14-H-011048	08.85					
1.5				08.82	07.83	24.3727-0150.2	580150	2	L=2020
1.6				08.83	07.92				
1.6 D				08.82	07.92				
1.8				08.85	07.92				
1.5				08.82	07.83	24.3728-0108.2	590108		L=794
1.6				08.83	07.92				
1.6 D				08.82	07.92				
1.8				08.85	07.92				
VOLKSWAGEN CORRADO (88-95)									
				04.89	07.92	03.7750-4302.4	300076		9"
1.8 16V	◀			10.88	09.93				
1.8 G60	◀			04.93	07.95				
2.0	◀			08.91	07.95				
2.0 16V	◀			08.91	07.95				
2.9 VR6	◀			08.91	07.95				
1.8 16V	▶			04.89	07.92	03.7750-4902.4	300079		9"
1.8 G60	▶			10.88	09.93				
2.0	▶			04.93	07.95				
2.0 16V	▶			08.91	07.95				
2.9 VR6	▶			08.91	07.95				

¹⁾ f.partno.-8007/8008 -8503/8504 / p.no.codice -8007/8008 -8503/8504 / p.AV ref. -8007/8008 -8503/8504 / p.ref. -8007/8008 -8503/8504

²⁾ + cast iron / + ghisa / + fonte grise / + fundición de gris

³⁾ + aluminium / + alluminio / + aluminium / + aluminio

VOLKSWAGEN CORRADO (88-95)										
										
	1.8 16V 1.8 G60 2.0 2.0 16V 2.9 VR6			04.89 10.88 04.93 08.91 07.95 08.91	07.92 09.93 07.95 07.95 - ABS - ABS	03.2122-1042.3 03.3517-0101.2	010137 390322		THz 22,20 Verschlusschraube	ATE
	1.8 16V 2.0 2.0 16V			04.89 04.93 08.91	07.92 07.95 07.95	24.3541-1609.5 24.3541-1610.5 24.0101-4301.2 11.0101-5403.2	240039 240040 260047 260010	<input type="checkbox"/> <input type="checkbox"/>	D=54, - Halter D=54, - Halter Bremsattel-Zubehör Faltenbalgsatz	LUC LUC LUC LUC
	1.8 G60	50-M-027000		10.88		24.3541-1719.5 24.3541-1720.5 24.0101-4301.2 11.0101-5403.2	240057 240058 260047 260010	<input type="checkbox"/> <input type="checkbox"/>	D=54, - Halter D=54, - Halter Bremsattel-Zubehör Faltenbalgsatz	LUC LUC LUC LUC
	1.8 G60 2.9 VR6	50-M-027001		09.93 08.91	07.95 07.95	24.3541-1731.5 24.3541-1732.5	240061 240062	<input type="checkbox"/> <input type="checkbox"/>	D=54, - Halter D=54, - Halter	LUC LUC
	1.8 16V 2.0 2.0 16V			04.89 04.93 08.91	07.92 07.95 07.95	13.0460-2957.2	602957		20168 16,0 /S	LUC
	1.8 G60 2.9 VR6			10.88 08.91	09.93 07.95	13.0460-2958.2	602958		20168 19,3 /S	LUC
	1.8 16V 2.0 2.0 16V			04.89 04.93 08.91	07.92 07.95 07.95	24.0120-0128.1 24.0320-0128.1	420128 520128		256 20,0 18,0 V L +S +B 256 20,0 18,0 V L +S +B PD	
	1.8 G60 2.9 VR6			10.88 08.91	09.93 07.95	24.0122-0101.1 24.0122-0100.1 24.0322-0100.1	422101 422100 522100		280 22,0 20,0 V L +B 280 22,0 20,0 V L +B 280 22,0 20,0 V L +B PD	
	1.8 16V 1.8 G60	50-M-035000		04.89 10.88		24.5237-0333.3	331425	2	L=333	
	1.8 16V 1.8 G60 2.0 2.0 16V 2.9 VR6	50-N-000001 50-N-000001		07.92 09.93 04.93 08.91 07.95 08.91		24.5105-0442.3	331432	2	L=442	
	1.8 16V 1.8 G60		50-L-035000 50-L-035000	04.89 10.88		24.0711-1313.3	360016	2 <input type="checkbox"/>	Radsensor L=1130	
	1.8 16V 1.8 G60	50-M-000001 50-M-000001	50-M-035000 50-M-035000			24.0711-1313.3	360016	2 <input type="checkbox"/>	Radsensor L=1130	
	1.8 16V 1.8 G60 2.0 2.0 16V 2.9 VR6	50-N-000001 50-N-000001		07.92 09.93 04.93 08.91		24.0711-1361.3 24.0711-1362.3	360022 360023	<input type="checkbox"/> <input type="checkbox"/>	Radsensor Radsensor	
	2.0 2.0 16V 2.9 VR6	50-R-003691 50-R-003691 50-R-003691		07.95 07.95 07.95		24.0711-1361.3 24.0711-1362.3	360022 360023	<input type="checkbox"/> <input type="checkbox"/>	Radsensor Radsensor	
	1.8 16V 1.8 G60 2.0 16V 2.9 VR6		50-P-009000 50-P-009000 50-P-009000	04.89 10.88 08.91 08.91	07.92	24.3384-1603.5 24.3384-1604.5 24.0101-3601.2	240015 240016 260044	<input type="checkbox"/> <input type="checkbox"/>	D=38, - Halter D=38, - Halter Bremsattel-Zubehör	LUC LUC LUC
	1.8 G60 2.0 2.0 16V 2.9 VR6	50-P-009001 50-P-009001 50-P-009001		09.93 04.93 07.95 07.95		24.3384-1707.5 24.3384-1708.5 24.0101-3601.2 11.0101-5403.2	240171 240172 260044 260010	<input type="checkbox"/> <input type="checkbox"/>	D=38, - Halter D=38, - Halter Bremsattel-Zubehör Faltenbalgsatz	LUC LUC LUC LUC
	1.8 16V 1.8 G60 2.0 2.0 16V 2.9 VR6		50-P-009000	04.89 10.88 04.93 08.91	07.92 07.95 07.95	13.0460-2937.2 13.0460-0419.2	602937 610419		20961 15,2 /Zub/S Belagsatz-Zubehör	LUC LUC
	1.8 G60 2.9 VR6	50-P-009001 50-P-009001		09.93 07.95		13.0460-2984.2 13.0460-0072.2	602984 610072		20961 17,2 /Zub/S Belagsatz-Zubehör	LUC LUC
	1.8 16V 1.8 G60 2.0 2.0 16V 2.9 VR6			04.89 10.88 04.93 08.91 07.95 08.91	07.92 09.93 07.95 07.95	24.0110-0111.1 24.0110-0275.2	410111 410275	ohne Sensorring ¹⁾ mit Sensorring ²⁾	226 10,0 8,0 +B 226 10,0 8,0	
				08.91	07.95	24.0110-0203.1 24.0110-0276.2	410203 410276	mit Sensorring ²⁾	226 10,0 8,0 +B 226 10,0 8,0	
	1.8 16V 1.8 G60 2.0 2.0 16V 2.9 VR6			04.89 10.88 04.93 08.91 07.95 08.91	07.92 09.93 07.95 07.95	24.5201-0164.3 24.5170-0161.3	331414 331308	2 2	am Bremsattel ³⁾	L=164 L=161
				08.91	07.95	83.7836-0135.3 24.5170-0161.3	330816 331308	2 2	am Bremsattel ³⁾	L=135 L=161
	1.8 16V 1.8 G60 2.0 2.0 16V 2.9 VR6	50-M-000001 50-M-000001		07.92 09.93 04.93 08.91		24.0721-1925.1	360039	2 <input type="checkbox"/>	Radsensor L=1220	
	2.0 2.0 16V 2.9 VR6	50-R-003691 50-R-003691 50-R-003691	50-R-003690 50-R-003690 50-R-003690	07.95 07.95 07.95		24.0721-1937.1	360040	2 <input type="checkbox"/>	Radsensor L=1062	

¹⁾ without sensor ring / senza sensori / sans secours ABS / sin anillo sensor ABS
²⁾ with sensor ring / con sensori / avec secours ABS / con anillo sensor ABS
³⁾ on the brake caliper / sulla pinza freno / sur l'étrier de frein / a la pinza de freno

VOLKSWAGEN CORRADO (88-95)														
	1.8 16V			04.89	07.92	24.3727-0134.2	580134	2	↓		L=1613			
	1.8 G60			10.88	09.93									
	2.0		50-S-000361	04.93		24.3727-0156.2	580156	2	↓		L=1616			
	2.0 16V		50-S-000361	08.91										
	2.9 VR6		50-S-000361	08.91		03.6584-0015.3	320109				BRL 8/4 (4) ATE			
	2.0		50-S-000362	07.95										
	2.0 16V		50-S-000362	07.95		03.6584-0113.3	320111				BRL 8/4 (4) ATE			
	2.9 VR6		50-S-000362	07.95										
	1.8 16V			04.89	07.92	03.2419-9310.3	030027				Gz 19,05			
	1.8 G60			10.88	09.93									
	2.0		50-R-000786	04.93		03.2419-1206.3	030074				Gz 19,05			
	2.0 16V		50-R-000786	08.91										
	2.9 VR6		50-R-000786	08.91		03.2419-1206.3	030074				Gz 19,05			
	2.0		50-R-000787	07.95										
	2.0 16V		50-R-000787	07.95		03.2523-0908.3	040049				Nz 23,81			
	2.9 VR6		50-R-000787	08.91	07.95									
VOLKSWAGEN DERBY/POLO Stufenheck (77-88)														
	0.9			01.77	09.81	03.2117-3311.3	010040				THz 17,46 Verschlusschraube ATE			
	1.0			10.81	02.85							03.3517-0101.2	390322	
	1.1			01.77	02.85									- Bremsgerät 1)
	1.3			01.77	02.85									- Bremsgerät 1)
	1.0		..-F-127903	10.81		03.2120-1531.3	010092				THz 20,64 ATE			
	1.1		..-F-127903	10.81								+ Bremsgerät 2)		
	1.1		..-F-127903	01.77	09.81							+ Bremsgerät 2)		
	1.3		..-F-127903	10.81								+ Bremsgerät 2)		
	1.3		..-F-127903	01.77	09.81	+ Bremsgerät 2)								
	1.0		..-F-127904		12.88	+ Bremsgerät 2)	03.2120-2031.3	010106			THz 20,64 ATE			
	1.1		..-F-127904		12.88	+ Bremsgerät 2)								
	1.3		..-F-127904		12.88	+ Bremsgerät 2)								
1.3 D		..-F-127904	08.86	12.88										
	0.9			01.77	09.81	03.3508-7504.3	310045				Behälter ATE			
	1.0			10.81	02.85									
	1.1			01.77	02.85							ohne Warneinrichtung 3)		
	1.3			01.77	02.85									
	0.9			01.77	09.81	11.0441-4402.2	250014				Dichtungssatz ATE			
	1.1			01.77	09.81									
	1.3			01.77	09.81									
	1.0		..-F-127903	10.81								11.0441-4402.2	250014	
1.1		..-F-127903	10.81											
1.3		..-F-127903	10.81											
1.0		..-F-127904		12.88	24.3481-1745.5	240277		D=48, - Halter ATE						
1.1		..-F-127904		12.88					24.3481-1746.5	240278				
1.3		..-F-127904		12.88							11.0441-4808.2	250022	Dichtungssatz ATE	
1.3 D		..-F-127904	08.86	12.88							11.0101-4803.2	260008	Hülzensatz ATE	
	0.9			01.77	09.81	13.0460-4028.2	604028				20228 15,3 ATE			
	1.1			01.77	09.81									
	1.3			01.77	09.81									
	1.0		..-F-127903	10.81								13.0460-4028.2	604028	
1.1		..-F-127903	10.81		13.0460-0115.2	610115								
1.3		..-F-127903	10.81											
1.0		..-F-127904		12.88			13.0460-7030.2	607030						
1.1		..-F-127904		12.88	13.0460-0184.2	610184								
1.3		..-F-127904		12.88										
1.3 D		..-F-127904	08.86	12.88										
	0.9			01.77	09.81	24.0108-0100.1	408100				239 8,0 7,0			
	1.1			01.77	09.81									
	1.3			01.77	09.81									
	1.0			10.81	12.88							24.0110-0151.1	410151	
1.1			10.81	12.88	24.0310-0151.1	510151								
1.3			10.81	12.88										
1.3 D			08.86	12.88										
	0.9			01.77	09.81	83.7734-0290.3	330809	2			L=290			
	1.0			01.77	12.88									
	1.1			01.77	12.88									
	1.3			01.77	12.88									
	1.3 D			08.86	12.88	83.7824-0180.3	330812	2			L=180			
	0.9			01.77	09.81									
	1.0			01.77	12.88									
	1.1			01.77	12.88									
	1.3			01.77	12.88									
	1.3 D			08.86	12.88									

1) - booster unit / - servofreno / - servo-frein / - servofreno

2) + booster unit / + servofreno / + servo-frein / + servofreno

3) without alarm / senza dispositivo d'allarme / sans dispositif d'avertissement / sin dispositivo avisador

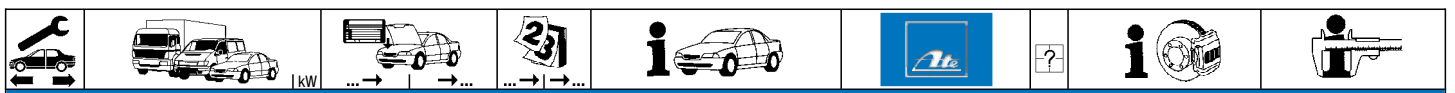

VOLKSWAGEN DERBY/POLO Stufenheck (77-88)

	0.9			01.77	09.81	- Bremskraftregler ¹⁾	03.3214-0812.3	020011	+ GG ²⁾	Rz 14,29
	1.0		..-F-127903	10.81		- Bremskraftregler ¹⁾				
	1.1		..-F-127903	01.77		- Bremskraftregler ¹⁾				
	1.3		..-F-127903	01.77		- Bremskraftregler ¹⁾				
	1.0		..-F-127904		12.88	- Bremskraftregler ¹⁾	03.3215-2311.3	020018	+ GG ²⁾	Rz 15,87
	1.1		..-F-127904		12.88	- Bremskraftregler ¹⁾	24.3215-0903.3	020154	+ ALU ³⁾	Rz 15,87
	1.3		..-F-127904		12.88	- Bremskraftregler ¹⁾				
	1.3 D			08.86	12.88	- Bremskraftregler ¹⁾				
	0.9			01.77	09.81	+ Bremskraftregler ⁴⁾	03.3217-2112.3	020027	+ GG ²⁾	Rz 17,46
	1.0		..-F-127903	10.81		+ Bremskraftregler ⁴⁾				
	1.1		..-F-127903	01.77		+ Bremskraftregler ⁴⁾				
	1.3		..-F-127903	01.77		+ Bremskraftregler ⁴⁾				
	1.0		..-F-127904		12.88	+ Bremskraftregler ⁴⁾	24.3219-0909.3	020188		Rz 19,05
	1.1		..-F-127904		12.88	+ Bremskraftregler ⁴⁾				
	1.3		..-F-127904		12.88	+ Bremskraftregler ⁴⁾				
	1.3 D			08.86	12.88	+ Bremskraftregler ⁴⁾				
	0.9			01.77	07.78		03.0137-9006.2	669006	- autom. Nachstellung ⁵⁾	Bremsbacken-Zubehör
	1.1			01.77	07.78					
	1.3			01.77	07.78					
	0.9			08.78	09.81		03.0137-0126.2	650126		180 x 31 HEB
	1.0			10.81	12.88		03.0137-9008.2	669008		Bremsbacken-Zubehör
	1.1			08.78	12.88					
	1.3			08.78	12.88					
	1.3 D			08.86	12.88					
	0.9			01.77	09.81		24.0218-0007.1	480003		180/181 x 38,5 - Lager
	1.0			10.81	12.88		24.0218-0707.2	480211		180/181 x 38,5 + Lager
	1.1			01.77	12.88					
	1.3			01.77	12.88					
	1.3 D			08.86	12.88					
	0.9			08.78	09.81	- Bremskraftregler ¹⁾	03.0520-0114.3	690114		14,29/180x31 TopKit VW
	1.0		..-F-127903	10.81		- Bremskraftregler ¹⁾				
	1.1		..-F-127903	08.78		- Bremskraftregler ¹⁾				
	1.3		..-F-127903	08.78		- Bremskraftregler ¹⁾				
	0.9			08.78	09.81	+ Bremskraftregler ⁴⁾	03.0420-0617.3	680617	+ Rz GG ⁶⁾	17,46/180x31 Kit VW
	1.0		..-F-127903	10.81		+ Bremskraftregler ⁴⁾	03.0520-3917.3	693917	+ Rz ALU ⁷⁾	17,46/180x31 TopKit VW
	1.1		..-F-127903	08.78		+ Bremskraftregler ⁴⁾				
	1.3		..-F-127903	08.78		+ Bremskraftregler ⁴⁾				
	1.0		..-F-127904		12.88	- Bremskraftregler ¹⁾	03.0520-0215.3	690215		15,87/180x31 TopKit VW
	1.1		..-F-127904		12.88	- Bremskraftregler ¹⁾				
	1.3		..-F-127904		12.88	- Bremskraftregler ¹⁾				
	1.3 D		..-F-127904	08.86	12.88	- Bremskraftregler ¹⁾				
	0.9			01.77	09.81		24.3727-0146.2	580146	1 ⬆	L=794
	1.0		..-E-200000	10.81			24.3727-0103.2	580103	1 ⬇	L=1960
	1.1		..-E-200000	01.77						
	1.3		..-E-200000	01.77						
	1.0		..-F-000001		12.88		24.3727-0137.2	580137	1 ⬆	L=1594
	1.1		..-F-000001		12.88		24.3727-0129.2	580129	2 ⬇	L=633
	1.3		..-F-000001		12.88					
	1.3 D		..-F-000001	08.86	12.88					
	1.0		..-F-000001		12.88		03.6584-0015.3	320109		BRL 8/4 (4) ATE
	1.1		..-F-000001		12.88					
	1.3		..-F-000001		12.88					
	1.3 D		..-F-000001	08.86	12.88					
	0.9			01.77	09.81		24.3728-0101.2	590101		L=607
	1.0		..-F-127903	10.81						
	1.1		..-F-127903	01.77						
	1.3		..-F-127903	01.77						
	1.3		..-F-127903	01.77						

VOLKSWAGEN GOLF I (74-83)

	1.1			04.74	07.79	+ Bremsgerät ⁸⁾	03.2120-1531.3	010092		Thz 20,64	ATE
	1.5			02.74	07.79	+ Bremsgerät ⁸⁾					
	1.6			04.74	07.79	+ Bremsgerät ⁸⁾					
	1.5 D			08.79	07.80	+ Bremsgerät ⁸⁾	03.2120-1491.3	010089		Thz 20,64 + WE	ATE
	1.6 D			08.80	07.81	+ Bremsgerät ⁸⁾					
	1.1			08.79	10.83	+ Bremsgerät ⁸⁾	03.2120-1531.3	010092		Thz 20,64	ATE
	1.3			08.79	10.83	+ Bremsgerät ⁸⁾	03.2120-1491.3	010089		Thz 20,64 + WE	ATE
	1.5			08.79	10.83	+ Bremsgerät ⁸⁾					
	1.6			08.79	10.83	+ Bremsgerät ⁸⁾					
	1.6 D			08.81	10.83	+ Bremsgerät ⁸⁾					
	1.6 GTI			08.79	07.82		03.2120-1491.3	010089		Thz 20,64 + WE	ATE
	1.6 TD			03.82	10.83						
	1.8 GTI			08.82	10.83						
	1.1			08.76	08.80	+ USA	03.2120-1821.3	010100		Thz 20,64	ATE
	1.3			08.79	08.80	+ USA					
	1.5			08.76	08.80	+ USA					
	1.5 D			08.76	08.80	+ USA					
	1.6			08.76	08.80	+ USA					
	1.6 GTI			08.76	08.80	+ USA					
	1.1			09.80	10.83	+ USA	03.2120-1821.3	010100		Thz 20,64	ATE
	1.3			09.80	10.83	+ USA					
	1.5			09.80	10.83	+ USA					
	1.6			09.80	10.83	+ USA					
	1.6 D			08.80	10.83	+ USA					
	1.6 GTI			09.80	07.82	+ USA					

¹⁾ - brake pressure regulator / - correttore di frenata / - correcteur de freinage / - corrector de frenado

²⁾ + cast iron / + ghisa / + fonte grise / + fundición de gris

³⁾ + aluminium / + alluminio / + aluminium / + aluminio

⁴⁾ + brake pressure regulator / + correttore di frenata / + correcteur de freinage / + corrector de frenado













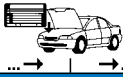















⁵⁾ - automatic adjustment / - correzione automatica / - ajustage automatique / - reajuste automatico

⁶⁾ + WC cast iron / + CR ghisa / + CR fontegrise / + CR fundición de gris

⁷⁾ + WC aluminium / + CR alluminio / + CR aluminium / + CR aluminio

⁸⁾ + booster unit / + servofreno / + servo-frein / + servofreno



								
VOLKSWAGEN GOLF I (74-83)								
	1.6 TD 1.8 GTI		03.82 08.82	10.83 + USA 10.83 + USA	03.2120-1821.3	010100		Thz 20,64 ATE
	1.1 1.5 1.5 D 1.6 1.6 GTI		04.74 02.74 08.76 04.74 06.76	07.79 07.79 07.79 07.79 07.79	03.3508-7504.3	310045	ohne Warneinrichtung ¹⁰⁾	Behälter ATE
	1.1 1.5 1.6		04.74 02.74 04.74	07.75 07.80 + Schwimmsättel ¹⁾ 07.80 + Schwimmsättel ¹⁾	11.0441-4402.2	250014		Dichtungssatz ATE
	1.1 1.3 1.5 D 1.6 D		08.75 08.79 08.76 08.80	10.83 10.83 07.80 10.83	11.0441-4402.2	250014		Dichtungssatz ATE
	1.6 GTI		06.76	07.80 + Schwimmsättel ¹⁾	11.0441-4402.2	250014		Dichtungssatz ATE
	1.5 1.6 1.6 GTI 1.6 TD 1.7 1.8 GTI		08.78 08.78 04.79 03.82 08.80 08.82	10.83 + Faustsättel ²⁾ 10.83 + Faustsättel ²⁾ 07.82 + Faustsättel ²⁾ 10.83 10.83 + J 10.83	11.0441-4808.2 11.0441-4804.2 11.0101-4801.2 24.0102-4801.2	250022 250019 260006 260085	f.Vornr -8007/8008 -8503/8504 ³⁾	Dichtungssatz Dichts.a.(+Sich.Ring) Hülensatz Hülensatz+Schrauben ATE ATE ATE ATE
	1.1 1.5 1.6		04.74 02.74 04.74	07.75 07.80 + Schwimmsättel ¹⁾ 07.80 + Schwimmsättel ¹⁾	13.0460-4029.2	604029		20228 18,5 ATE
	1.1 1.5 D		08.75 08.76	02.78 02.78	13.0460-4028.2 13.0460-0029.2 13.0460-0905.2	604028 610029 610905		20228 15,3 Belagsatz-Zubehör Belagsatz-Zubehör ATE ATE LUC
	1.1 1.3 1.5 D 1.6 D		03.78 08.79 03.78 08.80	10.83 10.83 07.80 10.83	13.0460-4028.2 13.0460-0115.2 13.0460-0905.2	604028 610115 610905		20228 15,3 Belagsatz-Zubehör Belagsatz-Zubehör ATE ATE LUC
	1.5 1.6 1.6 TD		08.78 08.78 03.82	10.83 + Faustsättel ²⁾ 10.83 + Faustsättel ²⁾ 10.83	13.0460-7032.2	607032		20887 19,7 +/Zub VW
	1.6 GTI 1.6 GTI 1.8 GTI		06.76 04.79 08.82	07.80 + Schwimmsättel ¹⁾ 07.82 + Faustsättel ²⁾ 10.83	13.0460-4028.2 13.0460-7033.2	604028 607033		20228 15,3 20887 15,3 +/Zub ATE VW
	1.1 1.5 1.6 1.6 TD 1.7		04.74 02.74 08.75 03.82 08.80	07.75 10.83 10.83 10.83 10.83 + J	24.0112-0106.1 24.0312-0106.1	412106 512106		239 12,0 10,0 +S +B 239 12,0 10,0 +S +B PD
	1.1 1.3 1.5 D 1.6 D		08.75 08.79 08.76 08.80	10.83 10.83 07.80 10.83	24.0110-0151.1 24.0310-0151.1	410151 510151		239 10,0 8,0 +S +B 239 10,0 8,0 +S +B PD
	1.6 GTI 1.8 GTI		06.76 08.82	07.82 10.83	24.0120-0123.1 24.0320-0123.1	420123 520123		239 20,0 18,0 V L +S +B 239 20,0 18,0 V L +S +B PD
	1.1 1.5 1.5 D 1.6 1.6 GTI		04.75 02.74 08.76 04.74 06.76	10.78 + VA-Scheibenbremse ⁴⁾ 10.78 10.78 10.78 10.78	83.6104-0325.3	330246	2	L=325 ATE
	1.1 1.3 1.5 1.5 D 1.6 1.6 D 1.6 GTI 1.6 TD 1.8 GTI		11.78 08.79 11.78 11.78 11.78 08.80 11.78 03.82 08.82	10.83 10.83 10.83 07.80 10.83 10.83 07.82 10.83 10.83	24.5170-0315.3 24.5108-0266.3	331309 330038	2 2	L=315 L=266 LUC
	1.1 1.3 1.5 1.5 D 1.6 1.6 D 1.6 GTI 1.6 TD 1.8 GTI		04.74 08.79 02.74 08.76 04.74 08.80 06.76 03.82 08.82	10.83 10.83 10.83 07.80 10.83 10.83 07.82 10.83 10.83	24.5201-0164.3	331414	2	L=164
	1.1 1.3 1.5 1.5 D 1.6 1.6 D 1.6 GTI 1.6 TD		04.74 08.79 02.74 08.76 04.74 08.80 06.76 03.82	10.83 10.83 10.83 + Schaltgetriebe ⁷⁾ 07.80 + Schaltgetriebe ⁷⁾ 10.83 + Schaltgetriebe/- (S) ⁸⁾ 10.83 + Schaltgetriebe ⁷⁾	03.3214-0812.3 24.3214-0902.3	020011 020147	+ GG ⁵⁾ + ALU ⁶⁾	Rz 14,29 Rz 14,29
	1.5 1.5 D 1.6 1.6 D		02.74 08.76 04.74 08.80	10.83 + Automatikgetriebe ⁹⁾ 07.80 + Automatikgetriebe ⁹⁾ 10.83 + S 10.83 + Automatikgetriebe ⁹⁾ 10.83 + Automatikgetriebe ⁹⁾	03.3217-2112.3 24.3217-0908.3	020027 020167	+ GG ⁵⁾ + ALU ⁶⁾	Rz 17,46 Rz 17,46

¹⁾ + floating calipers / + pinze flottante / + étriers flottant / + pinzas flotante

²⁾ + fist type calipers / + pinza freno flottante / + étriers à griffe / + pinza de puno

³⁾ f.partno.-8007/8008 -8503/8504 / p.no.codice -8007/8008 -8503/8504 / p.AV ref. -8007/8008 -8503/8504 / p. antes ref. -8007/8008 -8503/8504

⁴⁾ + FA disc brake / + A disco freno / + frein à disque essieu AV / + ED disco de freno

⁵⁾ + cast iron / + ghisa / + fonte grise / + fundición de gris









⁶⁾ + aluminium / + alluminio / + aluminium / + aluminio

⁷⁾ + manual transmission / + scatola cambio velocità / + transmission mécanique / + cambio de velocidad

⁸⁾ + manual transmission / - (S) / + scatola camb.velocità / - (S) / + transmission mécanique / - (S) / + cambio de velocidad / - (S)

⁹⁾ + autom.transmission / + scatola cambio automatico / + transmission automatique / + cambio automático

¹⁰⁾ without alarm / senza dispositivo d'allarme / sans dispositif d'avertissement / sin dispositivo avisador

VOLKSWAGEN GOLF I (74-83)											
	1.6 GTI 1.7 1.8 GTI			06.76 08.80 08.82	07.82 10.83 10.83	+ ①	03.3217-2112.3 24.3217-0908.3	020027 020167	+ GG 1) + ALU 2)	Rz 17,46 Rz 17,46	
	1.1 1.5 1.6 1.6 GTI			04.74 02.74 04.74 06.76	07.78 07.78 07.78 07.78		03.0137-9006.2	669006	- autom. Nachstellung 3)	Bremsbacken-Zubehör	
	1.1 1.3 1.5 1.5 D 1.6 1.6 D 1.6 GTI 1.6 TD 1.7 1.8 GTI			08.78 08.79 08.78 08.78 08.78 08.80 08.78 03.82 08.80 08.82	10.83 10.83 10.83 07.80 10.83 10.83 07.82 10.83 10.83 10.83	+ ①	03.0137-0126.2 03.0137-9008.2	650126 669008		180 x 31 HEB Bremsbacken-Zubehör	
	1.1 1.3 1.5 1.5 D 1.6 1.6 D 1.6 GTI 1.6 TD 1.8 GTI			04.74 08.79 02.74 08.76 04.74 08.80 06.76 03.82 08.82	10.83 10.83 10.83 07.80 10.83 10.83 07.82 10.83 10.83		24.0218-0007.1 24.0218-0707.2	480003 480211		180/181 x 38,5 - Lager 180/181 x 38,5 + Lager	
	1.1 1.3 1.5 1.5 D 1.6 1.6 D 1.6 TD 1.8 GTI			08.78 08.79 08.78 08.78 08.78 08.80 03.82	10.83 10.83 10.83 07.80 10.83 10.83 10.83	+ Schaltgetriebe 4) + Schaltgetriebe 4) + Schaltgetriebe/ - ⑤ 5) + Schaltgetriebe 4)	03.0520-0114.3	690114		14,29/180x31 TopKit	VW
	1.5 1.5 D 1.6 1.6 D 1.6 GTI 1.7 1.8 GTI			08.78 08.78 08.78 08.78 08.80 08.78 08.80 08.82	10.83 07.80 10.83 10.83 10.83 07.82 10.83 10.83	+ Automatikgetriebe 6) + Automatikgetriebe 6) + ⑤ + Automatikgetriebe 6) + Automatikgetriebe 6) + ①	03.0420-0617.3 03.0520-3917.3	680617 693917	+ Rz GG 7) + Rz ALU 8)	17,46/180x31 Kit 17,46/180x31 TopKit	VW VW
	1.1 1.3 1.5 1.5 D 1.6 1.6 D 1.6 GTI 1.6 TD 1.8 GTI			01.74 08.79 02.74 08.76 04.74 08.80 06.76 03.82 08.82	10.83 10.83 10.83 07.80 10.83 10.83 07.82 10.83 10.83		24.3727-0102.2	580102	2 ②	L=1690	
	1.1 1.3 1.5 1.5 D 1.6 1.6 D 1.6 GTI 1.6 TD 1.8 GTI			04.74 08.79 02.74 08.76 04.74 08.80 06.76 03.82 08.82	10.83 10.83 10.83 07.80 10.83 10.83 07.82 10.83 10.83		03.6565-0101.3	320097		BRL 6/5 (4)	ATE
	1.1 1.5 1.5 D 1.6 1.6 D 1.6 GTI 1.6 TD 1.7 1.8 GTI			08.75 02.74 08.76 04.74 08.80 06.76 03.82 08.80 08.82	10.83 10.83 07.80 10.83 10.83 07.82 10.83 10.83 10.83	+ ①	24.3728-0107.2 24.3728-0108.2	590107 590108		L=1055 L=794	
VOLKSWAGEN GOLF I Cabriolet (79-93)											
	1.1 1.5 1.6 1.6 GLI 1.8			01.79 01.79 08.83 07.79 08.82	07.83 07.83 08.83 07.82 08.82		03.2120-1531.3 03.2120-1491.3 03.3517-0101.2	010092 010089 390322		THz 20,64 THz 20,64 + WE Verschlußschraube	ATE ATE
	1.6 1.8	15-E-011291 15-E-011291	15-L-015000 15-L-015000				03.2120-2031.3 03.3517-0101.2	010106 390322		THz 20,64 Verschlußschraube	ATE
	1.6 1.8	15-L-015001 15-L-015001			12.92 08.93		03.2120-3943.3	010532		THz 20,64	ATE
	1.1 1.5 1.6 GLI			01.79 01.79 01.79	07.83 07.80 07.80	+ Schwimmsättel 9)	11.0441-4402.2	250014		Dichtungssatz	ATE
						+ Schwimmsättel 9)	11.0441-4402.2	250014		Dichtungssatz	ATE

1) + cast iron / + ghisa / + fonte grise / + fundición de gris

2) + aluminium / + alluminio / + aluminium / + aluminio

3) - automatic adjustment / - correzione automatica / - ajustage automatique / - reajuste automatico

4) + manual transmission / + scatola cambio velocità / + transmission mécanique / + cambio de velocidad

5) + manual transmission / - ⑤ / + scatola camb.velocità / - ⑤ / + transmission mécanique / - ⑤ / + cambio de velocidad / - ⑤

6) + autom.transmission / + scatola cambio automatico / + transmission automatique / + cambio automático

7) + WC cast iron / + CR ghisa / + CR fonte grise / + CR fundición de gris

8) + WC aluminium / + CR alluminio / + CR aluminium / + CR aluminio

9) + floating calipers / + pinze flottante / + étriers flottant / + pinzas flotante

VOLKSWAGEN GOLF I Cabriolet (79-93)											
	1.5			09.79	07.83	+ Faustsättel ¹⁾	11.0441-4808.2	250022	f.Vornr -8007/8008 -8503/8504 ²⁾	Dichtungssatz	ATE
	1.6			15-E-011290	08.83	+ Faustsättel ¹⁾	11.0441-4804.2	250019		Dichts.a.(+Sich.Ring)	ATE
	1.6 GLI				09.79	+ Faustsättel ¹⁾	11.0101-4801.2	260006		Hülzensatz	ATE
	1.8			15-E-011290	08.82		24.0102-4801.2	260085		Hülzensatz+Schrauben	ATE
	1.6		15-E-011291		12.92		11.0441-4808.2	250022		Dichtungssatz	ATE
	1.8		15-E-011291		08.93		11.0101-4801.2	260006		Hülzensatz	ATE
	1.1			01.79	07.83		13.0460-4028.2	604028		Hülzensatz+Schrauben	ATE
	1.5			01.79	07.80	+ Schwimmsättel ³⁾	13.0460-4029.2	604029		20228 15,3	ATE
				09.79	07.83	+ Faustsättel ¹⁾	13.0460-7032.2	607032		20887 19,7 +/Zub	VW
				08.83	12.92						
	1.6 GLI			07.79	07.80	+ Schwimmsättel ³⁾	13.0460-4028.2	604028		20228 15,3	ATE
	1.8			09.79	07.82	+ Faustsättel ¹⁾	13.0460-7033.2	607033		20887 15,3 +/Zub	VW
	1.1			01.79	07.83		24.0110-0151.1	410151		239 10,0 8,0 +S +B	
	1.5			01.79	07.83		24.0310-0151.1	510151		239 10,0 8,0 +S +B PD	
	1.6			08.83	12.92		24.0112-0106.1	412106		239 12,0 10,0 +S +B	
	1.6 GLI			07.79	07.82		24.0312-0106.1	512106		239 12,0 10,0 +S +B PD	
	1.8			08.82	08.93		24.0120-0123.1	420123		239 20,0 18,0 V L +S +B	
				08.82	08.93		24.0320-0123.1	520123		239 20,0 18,0 V L +S +B PD	
	1.1			01.79	07.83		24.5170-0315.3	331309	2	L=315	
	1.5			01.79	07.83		24.5108-0266.3	330038	2	L=266	LUC
	1.6			08.83	08.93						
	1.6 GLI			07.79	07.82						
	1.8			08.82	08.93						
	1.1			01.79	07.83		83.7824-0180.3	330812	2	L=180	
	1.5			01.79	07.83						
	1.6 GLI			07.79	07.82						
	1.8			08.82	07.83						
	1.6			08.83	07.93		24.5201-0164.3	331414	2	L=164	
	1.8			08.83	07.93						
	1.1			01.79	07.83	- Bremskraftregler ⁴⁾	03.3214-0812.3	020011	+ GG ⁵⁾	Rz 14,29	
	1.5			01.79	07.83	- Bremskraftregler ⁴⁾	24.3214-0902.3	020147	+ ALU ⁶⁾	Rz 14,29	
	1.6			15-E-011290	08.83	- Bremskraftregler ⁴⁾					
	1.6 GLI			07.79	07.82	- Bremskraftregler ⁴⁾					
	1.8			15-E-011290	08.82	- Bremskraftregler ⁴⁾					
	1.1			01.79	07.83	+ Bremskraftregler ⁷⁾	03.3217-2112.3	020027	+ GG ⁵⁾	Rz 17,46	
	1.5			01.79	07.83	+ Bremskraftregler ⁷⁾	24.3217-0908.3	020167	+ ALU ⁶⁾	Rz 17,46	
	1.6			15-E-011290	08.83	+ Bremskraftregler ⁷⁾					
	1.6 GLI		15-E-011291		12.92						
	1.8			07.79	07.82	+ Bremskraftregler ⁷⁾					
			15-E-011291		08.82	+ Bremskraftregler ⁷⁾					
	1.1			01.79	07.83		03.0137-0126.2	650126		180 x 31 HEB	
	1.5			01.79	07.83		03.0137-9008.2	669008		Bremsbacken-Zubehör	
	1.6			08.83	08.93						
	1.6 GLI			07.79	07.82						
	1.8			08.82	08.93						
	1.1			01.79	07.83		24.0218-0007.1	480003		180/181 x 38,5 - Lager	
	1.5			01.79	07.83		24.0218-0707.2	480211		180/181 x 38,5 + Lager	
	1.6			08.83	08.93						
	1.6 GLI			07.79	07.82						
	1.8			08.82	08.93						
	1.1			01.79	07.83	- Bremskraftregler ⁴⁾	03.0520-0114.3	690114		14,29/180x31 TopKit	VW
	1.5			01.79	07.83	- Bremskraftregler ⁴⁾					
	1.6			15-E-011290	08.83	- Bremskraftregler ⁴⁾					
	1.6 GLI			09.79	07.82	- Bremskraftregler ⁴⁾					
	1.8			15-E-011290	08.82	- Bremskraftregler ⁴⁾					
	1.1			01.79	07.83	+ Bremskraftregler ⁷⁾	03.0420-0617.3	680617	+ Rz GG ⁸⁾	17,46/180x31 Kit	VW
	1.5			01.79	07.83	+ Bremskraftregler ⁷⁾	03.0520-3917.3	693917	+ Rz ALU ⁹⁾	17,46/180x31 TopKit	VW
	1.6			15-E-011290	08.83	+ Bremskraftregler ⁷⁾					
	1.6 GLI		15-E-011291		12.92						
	1.8			07.79	07.82	+ Bremskraftregler ⁷⁾					
			15-E-011291		08.82	+ Bremskraftregler ⁷⁾					
					08.93						
	1.1			01.79	07.83		24.3727-0102.2	580102	2	L=1690	
	1.5			01.79	07.83						
	1.6			08.83	04.92						
	1.6 GLI			07.79	07.82						
	1.8			08.82	04.93						
	1.1			01.79	07.83		03.6565-0101.3	320097		BRL 6/5 (4)	ATE
	1.5			01.79	07.83						
	1.6			15-E-011290	08.83						
	1.6 GLI			01.79	07.82						
	1.8			15-E-011290	08.82						
	1.1			01.79	07.83		24.3728-0107.2	590107		L=1055	
	1.5			01.79	07.83		24.3728-0108.2	590108		L=794	
	1.6			08.83	12.92						
	1.6 GLI			01.79	07.82						
	1.8			08.82	08.93						

¹⁾ + fist type calipers / + pinza freno flottante / + étriers à griffe / + pinza de puno
²⁾ f.partno.-8007/8008 -8503/8504 / p.no.codice -8007/8008 -8503/8504 / p.AV ref. -8007/8008 -8503/8504 / p. antes ref. -8007/8008 -8503/8504

³⁾ + floating calipers / + pinze flottante / + étriers flottant / + pinzas flotante

⁴⁾ - brake pressure regulator / - correttore di frenata / - correcteur de freinage / - corrector de frenado

⁵⁾ + cast iron / + ghisa / + fonte grise / + fundición de gris

⁶⁾ + aluminium / + alluminio / + aluminium / + aluminio

⁷⁾ + brake pressure regulator / + correttore di frenata / + correcteur de freinage / + corrector de frenado

⁸⁾ + WC cast iron / + CR ghisa / + CR fontegrise / + CR fundición de gris

⁹⁾ + WC aluminium / + CR alluminio / + CR aluminium / + CR aluminio

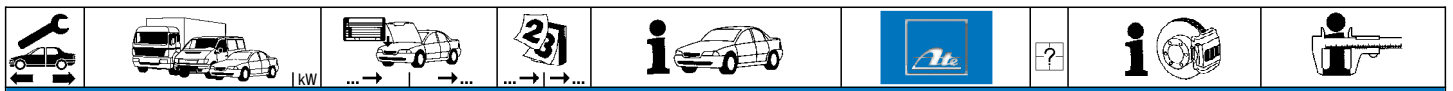

VOLKSWAGEN GOLF II (84-93)

	1.6			08.83	07.87	- ABS/ + Automatikgetriebe ¹⁾	03.6750-0202.4	300033		9°	ATE	
	1.6			08.87	12.93	- ABS						
	1.6 D			08.83	07.89	- ABS/ + Automatikgetriebe ¹⁾						
	1.6 TD			08.83	07.89	- ABS						
	1.8			08.83	07.89	- ABS						
	1.8 GTI		1G-KW240000	01.84		- ABS						
	1.8 GTI		1G-KB075000	01.84		- ABS						
	1.8 GTI 16V		1G-KW240000	02.86		- ABS						
	1.8 GTI 16V		1G-KB075000	02.86		- ABS						
	1.8 Rallye			04.89	07.92	- ABS						
1.8 Syncro			08.85	07.92	- ABS							
1.8 Syncro G60			04.89	07.92	- ABS							
	1.6 D			08.89	07.92	- ABS	03.7750-4302.4	300076		9°	ATE	
	1.6 TD			08.89	12.93	- ABS						
	1.8			08.89	07.92	- ABS						
	1.8 G60			04.90	07.92	- ABS						
	1.8 GTI		1G-KW240001		07.92	- ABS						
	1.8 GTI		1G-KB075001		07.92	- ABS						
	1.8 GTI 16V		1G-KW240001		07.92	- ABS						
	1.8 GTI 16V		1G-KB075001		07.92	- ABS						
	1.6			08.89	12.93	- ABS	03.7750-4902.4	300079		9°	ATE	
	1.6 D			08.89	07.92	- ABS						
1.6 TD			08.89	12.93	- ABS							
1.8			08.89	07.92	- ABS							
1.8 G60			04.90	07.92	- ABS							
1.8 GTI		1G-KW240001		07.92	- ABS							
1.8 GTI		1G-KB075001		07.92	- ABS							
1.8 GTI 16V		1G-KW240001		07.92	- ABS							
1.8 GTI 16V		1G-KB075001		07.92	- ABS							
	1.0			08.83	10.91	- ABS	03.2120-2031.3	010106		THz 20,64	ATE	
	1.3			08.83	12.93	- ABS	03.3517-0101.2	390322		Verschlußschraube		
	1.6			08.83	12.93	- ABS						
	1.6 D			08.83	07.89	- ABS						
	1.6 TD			08.83	07.89	- ABS						
	1.8			08.83	07.89	- ABS						
	1.8 GTI		1G-KW240000	01.84		- ABS						
	1.8 GTI		1G-KB075000	01.84		- ABS						
	1.8 GTI 16V		1G-KW240000	02.86		- ABS						
	1.8 GTI 16V		1G-KB075000	02.86		- ABS						
1.8 Rallye			04.89	07.92	- ABS							
1.8 Syncro			08.85	07.92	- ABS							
1.8 Syncro G60			04.89	07.92	- ABS							
	1.6 D			08.89	07.92	- ABS	03.2120-3943.3	010532		THz 20,64	ATE	
	1.6 TD			08.89	12.93	- ABS	03.3517-0101.2	390322		Verschlußschraube		
	1.8			08.89	07.92	- ABS						
	1.8 G60			04.90	07.92	- ABS	03.2122-1042.3	010137		THz 22,20	ATE	
	1.8 GTI		1G-KB075001		07.92	- ABS	03.3517-0101.2	390322		Verschlußschraube		
	1.8 GTI		1G-KW240001		07.92	- ABS						
	1.8 GTI 16V		1G-KB075001		07.92	- ABS						
	1.8 GTI 16V		1G-KW240001		07.92	- ABS						
		1.0		19-E-855000	08.83			24.3481-1745.5	240277		D=48, - Halter	ATE
		1.0			08.83	07.86		24.3481-1746.5	240278		D=48, - Halter	ATE
1.0				08.86	10.91	- ABS	11.0441-4808.2	250022		Dichtungssatz	ATE	
1.3			19-E-855000	08.83			11.0101-4803.2	260008		Hülssensatz	ATE	
1.3				08.83	07.86		24.0102-4803.2	260086		Hülssensatz+Schrauben	ATE	
1.3				08.86	12.93	- ABS						
1.6 D			19-E-855000	08.83		- ⊖						
1.6 D				08.83	07.86	- ⊖						
1.6 D				08.86	07.92	+ Schaltgetriebe ²⁾						
1.0			19-E-855001		08.89	10.91	+ ABS	11.0441-4808.2	250022		Dichtungssatz	ATE
1.0				08.89	10.91	+ ABS	11.0101-4801.2	260006		Hülssensatz	ATE	
1.3		19-E-855001		08.89	07.86		24.0102-4801.2	260085		Hülssensatz+Schrauben	ATE	
1.3				08.89	12.93	+ ABS						
1.6				08.83	12.93							
1.6 D		19-E-855001		08.83	07.86	- ⊖						
1.6 D				08.83	07.86	+ ⊖						
1.6 D				08.86	07.92	+ Automatikgetriebe ³⁾						
1.6 TD				08.83	12.93							
1.8				08.83	07.92							
1.8 GT				08.85	07.92							
1.8 GT Special				08.85	07.92							
1.8 GTI				01.84	07.92							
1.8 GTI 16V		1G-KW240000		02.86								
1.8 GTI 16V		1G-KB075000		02.86								
1.8 Syncro				08.85	07.92							
	1.8 GTI 16V		1G-KW240001		07.92		24.3541-1609.5	240039		D=54, - Halter	LUC	
	1.8 GTI 16V		1G-KB075001		07.92		24.3541-1610.5	240040		D=54, - Halter	LUC	
							24.0101-4301.2	260047		Bremssattel-Zubehör	LUC	
							11.0101-5403.2	260010		Fallenbalgsatz	LUC	
	1.8 G60		1G-MW720000	04.90			24.3541-1719.5	240057		D=54, - Halter	LUC	
	1.8 G60		1G-MB225000	04.90			24.3541-1720.5	240058		D=54, - Halter	LUC	
	1.8 Rallye		1G-MW720000	04.89			24.0101-4301.2	260047		Bremssattel-Zubehör	LUC	
	1.8 Rallye		1G-MB225000	04.89			11.0101-5403.2	260010		Fallenbalgsatz	LUC	
	1.8 Syncro G60		1G-MW720000	04.89								
	1.8 Syncro G60		1G-MB225000	04.89								

¹⁾ - ABS/ + autom.transmission / - ABS/ + scatola cambio autom. / - ABS/ + transmission automatique / - ABS/ + cambio automático

²⁾ + manual transmission / + scatola cambio velocità / + transmission mécanique / + cambio de velocidad

³⁾ + autom.transmission / + scatola cambio automatico / + transmission automatique / + cambio automático



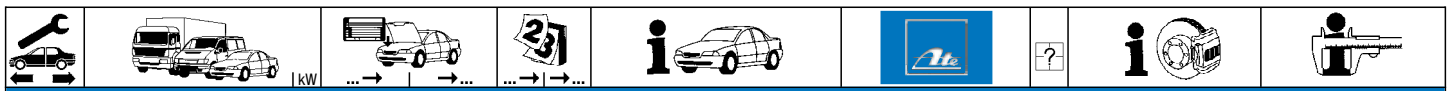

VOLKSWAGEN GOLF II (84-93)

	1.8 G60 1.8 G60 1.8 Rallye 1.8 Rallye 1.8 Syncro G60 1.8 Syncro G60	1G-MW720001 1G-MB225001 1G-MW720001 1G-MB225001 1G-MW720001 1G-MB225001		07.92 07.92 07.92 07.92 07.92 07.92		24.3541-1731.5 24.3541-1732.5	240061 240062		D=54, - Halter D=54, - Halter	LUC LUC
	1.0 1.0 1.0 1.3 1.3 1.3 1.6 1.6 D 1.6 D 1.6 D		19-E-855000 19-E-855000 19-E-855000 19-E-855000	08.83 08.83 08.86 08.83 08.86 08.83 08.83 08.83 08.86 08.86					20889 17,3 /Zub Belagsatz-Zubehör	VW VW
	1.0 1.0 1.3 1.3 1.6 1.6 1.6 D 1.6 D 1.6 D 1.6 TD 1.8 1.8 1.8 Syncro	53	19-E-855001 19-E-855001 19-E-855001 19-E-855001	07.86 08.89 08.89 08.86 08.83 08.83 08.86 08.83 08.83 08.83 01.84 01.84 08.85		13.0460-7030.2 13.0460-0184.2	607030 610184		20887 19,7 +/Zub	VW
	1.8 1.8 1.8 1.8 GT 1.8 GT Special 1.8 GTI 1.8 GTI 16V 1.8 GTI 16V	62 66 77	19-JH560001 19-JH560001	07.92 07.92 08.88 08.85 08.85 01.84 02.86 02.86		13.0460-7033.2	607033		20887 15,3 +/Zub	VW
	1.8 GTI 16V 1.8 GTI 16V		1G-KW240001 1G-KB075001	07.92 07.92		13.0460-2957.2	602957		20168 16,0 /S	LUC
	1.8 G60 1.8 Rallye 1.8 Syncro G60			04.90 04.89 04.89	07.92 07.92 07.92	13.0460-2958.2	602958		20168 19,3 /S	LUC
	1.0 1.0 1.0 1.3 1.3 1.3 1.6 1.6 D 1.6 D 1.6 D	53	19-E-855000 19-E-855000 19-E-855000 19-E-855000	08.83 08.83 08.86 08.83 08.86 08.83 08.83 08.83 08.86 08.86		24.0110-0151.1 24.0310-0151.1	410151 510151		239 10,0 8,0 +S +B 239 10,0 8,0 +S +B PD	
	1.0 1.0 1.3 1.3 1.6 1.6 1.6 D 1.6 D 1.6 D 1.6 TD 1.8 1.8 1.8 Syncro	55	19-E-855001 19-E-855001 19-E-855001	07.86 08.89 08.89 08.86 08.83 08.83 08.86 08.83 08.83 08.83 01.84 01.84 08.85		24.0112-0106.1 24.0312-0106.1	412106 512106		239 12,0 10,0 +S +B 239 12,0 10,0 +S +B PD	
	1.8 1.8 1.8 1.8 GT 1.8 GT Special 1.8 GTI 1.8 GTI 16V 1.8 GTI 16V	62 66 77	19-JH560001 19-JH560001	01.84 07.92 07.92 08.88 08.85 08.85 01.84 02.86 02.86		24.0120-0123.1 24.0320-0123.1	420123 520123		239 20,0 18,0 V L +S +B 239 20,0 18,0 V L +S +B PD	
	1.8 GTI 16V 1.8 GTI 16V		1G-KW240001 1G-KB075001	07.92 07.92		24.0120-0128.1 24.0320-0128.1	420128 520128		256 20,0 18,0 V L +S +B 256 20,0 18,0 V L +S +B PD	
	1.8 G60 1.8 Rallye 1.8 Syncro G60			04.90 04.89 04.89	07.92 07.92 07.92	24.0122-0101.1	422101		280 22,0 20,0 V L +B	
	1.0 1.3 1.6 1.6 D 1.6 TD 1.8 1.8 GTI		1G-KW240000	08.83 08.83 08.83 08.83 08.83 08.83 01.84	10.91 12.93 12.93 07.92 12.93 07.92	24.5170-0315.3	331309	2	L=315	

1) + manual transmission / + scatola cambio velocità / + transmission mécanique / + cambio de velocidad
2) + autom.transmission / + scatola cambio automatico / + transmission automatique / + cambio automático



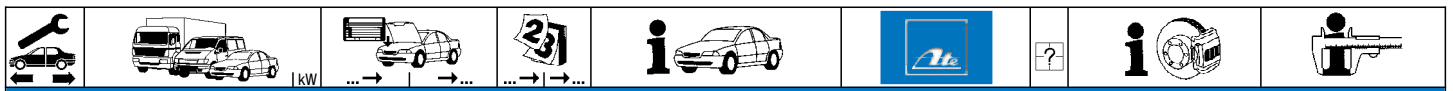

VOLKSWAGEN GOLF II (84-93)

	1.8 GTI 1.8 GTI 16V 1.8 GTI 16V 1.8 Syncro		1G-KB075000 01.84 1G-KW240000 02.86 1G-KB075000 02.86 08.85 07.92		24.5170-0315.3	331309	2		L=315
	1.8 GTI 1.8 GTI 1.8 GTI 16V 1.8 GTI 16V	1G-KW240001 1G-KB075001 1G-KW240001 1G-KB075001			83.6225-0287.3	330735	2		L=285
	1.8 G60 1.8 Rallye 1.8 Syncro G60		04.90 07.92 04.89 07.92 04.89 07.92		24.5237-0333.3	331425	2		L=333
	1.0 1.3 1.6 1.6 D 1.6 TD 1.8 1.8 G60 1.8 GTI 1.8 GTI 16V 1.8 Rallye 1.8 Syncro 1.8 Syncro G60		08.86 10.91 08.86 12.93 08.86 12.93 08.86 07.92 08.86 12.93 08.86 07.92 04.90 07.92 08.86 07.92 02.86 07.92 04.89 07.92 02.86 07.92 04.89 07.92		24.0711-1313.3	360016	2		Radsensor L=1130
	1.8 GT 1.8 GTI 1.8 GTI 16V		08.85 07.88 01.84 07.88 02.86 07.88	- ABS / - Special 1) - ABS - ABS	24.3364-1605.5 24.3364-1606.5 24.0101-3601.2 11.0101-5403.2	240011 240012 260044 260010		D=36, - Halter D=36, - Halter Bremsattel-Zubehör Fallenbalgsatz	LUC LUC LUC LUC
	1.8 1.8 1.8 GT 1.8 GTI 1.8 GTI 16V 1.8 Rallye 1.8 Rallye 1.8 Syncro G60 1.8 Syncro G60	62 19-JH480001 66 19-JH480001 19-JH480001 19-JH480001 19-JH480001	07.88 07.88 07.88 07.88 07.88 04.89 04.89 04.89 04.89	+ ABS + ABS + ABS / - Special 2) + ABS + ABS	24.3384-1603.5 24.3384-1604.5 24.0101-3601.2 260044	240015 240016 260044		D=38, - Halter D=38, - Halter Bremsattel-Zubehör	LUC LUC LUC
	1.8 1.8 1.8 GT 1.8 GTI 1.8 GTI 16V	62 66	08.88 08.88 08.88 08.88 08.88	+ ABS + ABS - Special 3)	24.3364-1605.5 24.3364-1606.5 24.0101-3601.2 11.0101-5403.2	240011 240012 260044 260010		D=36, - Halter D=36, - Halter Bremsattel-Zubehör Fallenbalgsatz	LUC LUC LUC LUC
	1.8 1.8 1.8 G60 1.8 GT 1.8 GT Special 1.8 GTI 1.8 GTI 16V 1.8 Rallye 1.8 Rallye 1.8 Syncro G60 1.8 Syncro G60	62 66	08.89 08.89 04.90 08.89 08.85 08.89 08.89 08.89 07.92 07.92 07.92 07.92	+ ABS + ABS	24.3384-1603.5 24.3384-1604.5 24.0101-3601.2 260044	240015 240016 260044		D=38, - Halter D=38, - Halter Bremsattel-Zubehör	LUC LUC LUC
	1.8 1.8 1.8 G60 1.8 GT 1.8 GT Special 1.8 GTI 1.8 GTI 16V 1.8 Rallye 1.8 Syncro G60	62 19-JH480001 66 19-JH480001	07.92 07.92 04.90 08.85 08.85 01.84 02.86 04.89 04.89	+ ABS + ABS	13.0460-2937.2 13.0460-0419.2	602937 610419		20961 15.2 / Zub/S Belagsatz-Zubehör	LUC LUC
	1.8 1.8 1.8 G60 1.8 GT 1.8 GT Special 1.8 GTI 1.8 GTI 16V	62 19-JH480001 66 19-JH480001	07.92 07.92 04.90 08.85 08.85 01.84 02.86	+ ABS + ABS	24.0110-0111.1 24.0110-0275.2	410111 410275		ohne Sensorring 4) mit Sensorring 5)	226 10,0 8,0 +B 226 10,0 8,0
	1.8 Rallye 1.8 Syncro G60		04.89 04.89		24.0110-0151.1	410151			239 10,0 8,0 +S +B
	1.0 1.3 1.6 1.6 D 1.6 TD 1.8 1.8 1.8 Rallye 1.8 Syncro G60		08.83 07.88 08.83 07.88 08.83 07.88 08.83 07.88 08.83 07.88 01.84 07.88 01.84 07.88 04.89 07.92 04.89 07.92	- ABS - ABS	83.7824-0180.3	330812	2		L=180
	1.0 1.3 1.6 1.6 D 1.6 TD 1.8 1.8	62 66	08.88 10.91 08.88 12.93 08.88 12.93 08.88 07.92 08.88 12.93 08.88 07.92 08.88 07.92	- ABS - ABS	24.5201-0164.3	331414	2		L=164

1) - ABS/ - Special / - ABS/ - Speciale / - ABS/ - Spécial / - ABS/ - Especial
 2) + ABS/ - Special / + ABS/ - Speciale / + ABS/ - Spécial / + ABS/ - Especial
 3) - Special / - Speciale / - Spécial / - Especial
 4) without sensor ring / senza sensori / sans secours ABS / sin anillo sensor ABS
 5) with sensor ring / con sensori / avec secours ABS / con anillo sensor ABS



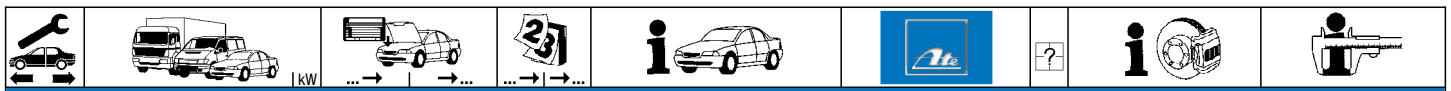

VOLKSWAGEN GOLF II (84-93)

	1.8	62	19-JH480001		07.92	+ ABS	24.5170-0161.3	331308	2		L=161										
	1.8	66	19-JH480001		07.92	+ ABS															
	1.8 G60				04.90	07.92															
	1.8 GT				08.85	07.92															
	1.8 GTI				01.84	07.92															
	1.8 GTI 16V				02.86	07.92															
1.8 Syncro				08.85	07.92	24.5201-0164.3	331414	2		L=164											
	1.0		1G-M-000001		10.91		24.0721-1925.1	360039	2		Radsensor L=1220										
	1.3		1G-M-000001		12.93																
	1.6		1G-M-000001		12.93																
	1.6 D		1G-M-000001		07.92																
	1.6 TD		1G-M-000001		12.93																
	1.8		1G-M-000001		07.92																
	1.8 G60		1G-M-000001		07.92																
	1.8 GTI		1G-M-000001		07.92																
	1.8 GTI 16V		1G-M-000001		07.92																
	1.8 Syncro				07.92																
	1.0				08.83	10.91 - Bremskraftregler 1)	03.3214-0812.3	020011		+ GG 2) + ALU 3)	Rz 14,29 Rz 14,29										
	1.3				08.83	12.93 - Bremskraftregler 1)															
	1.6				08.83	12.93 - Bremskraftregler 1)															
	1.6 D				08.83	07.92 - Bremskraftregler 1)															
	1.6 TD				08.83	12.93 - Bremskraftregler 1)															
	1.8	62			01.84	07.92 - Bremskraftregler 1)															
	1.8	66			01.84	07.92 - Bremskraftregler 1)															
	1.8	77	1G-KW593279		08.88	+ 4)															
	1.0				08.83	10.91 + Bremskraftregler 4)						03.3217-2112.3	020027		+ GG 2) + ALU 3)	Rz 17,46 Rz 17,46					
	1.3				08.83	12.93 + Bremskraftregler 4)															
	1.6				08.83	12.93 + Bremskraftregler 4)															
	1.6 D				08.83	07.92 + Bremskraftregler 4)															
	1.6 TD				08.83	12.93 + Bremskraftregler 4)															
	1.8	62			01.84	07.92 + Bremskraftregler 4)															
	1.8	66			01.84	07.92 + Bremskraftregler 4)															
	1.8	77	1G-KW593280		07.92	+ 4)															
	1.8 Syncro				08.85	07.92											24.3219-0909.3	020188			Rz 19,05
		1.0				08.83											10.91	03.0137-0126.2	650126		
1.3					08.83	12.93															
1.6					08.83	12.93															
1.6 D					08.83	07.92															
1.6 TD					08.83	12.93 - 4)															
1.8		62			01.84	07.92 - ABS															
1.8		66			01.84	07.92 - ABS															
1.8		77			08.88	07.92 - ABS + 4)															
1.6 TD					08.89	12.93 + 4)	03.0137-0268.2	650268			200 x 40 HEB Bremsbacken-Zubehör										
1.8		77			08.88	07.92 + ABS + 4)						03.0137-9168.2	669168								
1.8 Syncro				08.85	07.92	03.0137-0264.2	650264			230 x 40 HEB	VW										
	1.0				08.83	10.91	24.0218-0007.1	480003			180/181 x 38,5 - Lager 180/181 x 38,5 + Lager										
	1.3				08.83	12.93															
	1.6				08.83	12.93															
	1.6 D				08.83	07.92															
	1.6 TD				08.83	12.93 - 4)															
	1.8	62			01.84	07.92 - ABS															
	1.8	66			01.84	07.92 - ABS															
	1.8	77			08.88	07.92 - ABS + 4)															
	1.6 TD				08.89	12.93 + 4)						24.0220-0018.1	480019			200/201 x 50,5 - Lager 200/201,5 x 50,5 + Lager					
	1.8	77			08.88	07.92 + ABS + 4)											24.0220-0718.2	480209			
1.8 Syncro				08.85	07.92	24.0223-0017.1	480135			230/231,5 x 48,5											
	1.0				08.83	10.91 - Bremskraftregler/ - 4) 6)	03.0520-0114.3	690114			14,29/180x31 TopKit										
	1.3				08.83	12.93 - Bremskraftregler/ - 4) 6)															
	1.6				08.83	12.93 - Bremskraftregler/ - 4) 6)															
	1.6 D				08.83	07.92 - Bremskraftregler/ - 4) 6)															
	1.6 TD				08.83	12.93 - Bremskraftregler/ - 4) 6)															
	1.8	62			01.84	07.92 - Bremskraftregler/ - 4) 6)															
	1.8	66			01.84	07.92 - Bremskraftregler/ - 4) 6)															
	1.0				08.83	10.91 + Bremskraftregler/ - 4) 7)						03.0420-0617.3	680617		+ Rz GG 8) + Rz ALU 9)	17,46/180x31 Kit 17,46/180x31 TopKit					
	1.3				08.83	12.93 + Bremskraftregler/ - 4) 7)															
	1.6				08.83	12.93 + Bremskraftregler/ - 4) 7)															
1.6 D				08.83	07.92 + Bremskraftregler/ - 4) 7)																
1.6 TD				08.83	12.93 + Bremskraftregler/ - 4) 7)																
1.8	62			01.84	07.92 + Bremskraftregler/ - 4) 7)																
1.8	66			01.84	07.92 + Bremskraftregler/ - 4) 7)																
1.6 TD				08.89	12.93	03.0420-1517.3	681517			17,46/200x40 Kit 17,46/200x40 TopKit											
1.8	77	1G-KW593280		07.92	03.0520-1517.3						691517										
	1.0				08.83	07.88	24.3727-0118.2	580118	2		L=1748										
	1.3				08.83	07.88															
	1.6				08.83	07.88															
	1.6 D				08.83	07.88															
	1.6 TD				08.83	07.88															
	1.8				01.84	07.88 - ABS															
	1.8	66			01.84	07.88 - ABS															
	1.0				08.88	10.91						24.3727-0132.2	580132	2		L=1527					
	1.3				08.88	12.93															
	1.6				08.88	12.93															
1.6 D				08.88	07.92																
1.6 TD				08.88	12.93																
1.8	62			08.88	07.92 - ABS																
1.8	66			08.88	07.92 - ABS																

1) - brake pressure regulator / - correttore di frenata / - correcteur de freinage / - corrector de frenado
 2) - cast iron / + ghisa / + fonte grise / + fundición de gris
 3) - aluminium / + alluminio / + aluminio / + aluminio
 4) + brake pressure regulator / + correttore di frenata / + correcteur de freinage / + corrector de frenado
 5) without sensor ring / senza sensori / sans secours ABS / sin anillo sensor ABS
 6) - brake pressure regulator/ - 4) / - correttore di frenata/ - 4) / - correcteur de freinage/ - 4) / - corrector de frenado/ - 4)

7) + brake pressure regulator/ - 4) / + correttore di frenata/ - 4) / + correcteur de freinage/ - 4) / + corrector de frenado/ - 4)
 8) + WC cast iron / + CR ghisa / + CR fonte grise / + CR fundición de gris
 9) + WC aluminium / + CR alluminio / + CR aluminio / + CR aluminio

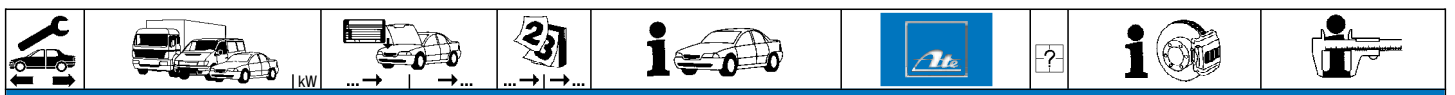

VOLKSWAGEN GOLF II (84-93)

	1.8 GT		08.85	07.88	- ABS	24.3727-0123.2	580123	2 ↓		L=1800
	1.8 GTI		01.84	07.88	- ABS					
	1.8 GTI 16V		02.86	07.88	- ABS					
	1.8	19-JH480001		07.88	+ ABS	24.3727-0124.2	580124	2 ↓		L=1840
	1.8 GT	19-JH480001		07.88	+ ABS					
	1.8 GTI	19-JH480001		07.88	+ ABS					
	1.8 GTI 16V	19-JH480001		07.88	+ ABS					
	1.8		08.88	07.92	+ ABS	24.3727-0133.2	580133	2 ↓		L=1622
	1.8 GT		08.88	07.92						
	1.8 GTI		08.88	07.92						
	1.8 GTI 16V		08.88	07.92						
	1.8 Syncro		08.85	07.92		24.3727-0166.2	580166	2 ↓		L=1567
	1.8 G60		04.90	07.92		24.3727-0134.2	580134	2 ↓		L=1613
	1.0		08.83	10.91		03.6584-0015.3	320109			BRL 8/4 (4) ATE
	1.3		08.83	12.93						
	1.6		08.83	12.93						
	1.6 D		08.83	07.92						
	1.6 TD		08.83	12.93						
	1.8		08.83	07.92						
	1.8 G60		08.89	07.92						
	1.8 GTI		01.84	07.92						
	1.8 GTI 16V		02.86	07.92						
	1.8 Rallye		04.89	07.92						
	1.8 Syncro		04.89	07.92						
	1.8 Syncro G60		04.89	07.92						
	1.8 G60		04.90	07.92		03.2419-9310.3	030027			Gz 19,05
	1.8 GTI		08.89	07.92						
	1.8 GTI 16V		08.89	07.92						
	1.8 Rallye		04.89	07.92						
	1.8 Syncro G60		04.89	07.92						
	1.8 G60		04.90	07.92		24.2523-0908.3	040049			Nz 23,81
	1.8 GTI		08.89	07.92						
	1.8 GTI 16V		08.89	07.92						
	1.8 Rallye		04.89	07.92						
	1.8 Syncro G60		04.89	07.92						
	1.0		08.83	10.91		24.3728-0113.2	590113		- autom. Nachstellung 1)	L=1098
	1.3		08.83	12.93					- autom. Nachstellung 1)	L=806
	1.6		08.83	12.93		24.3728-0111.2	590111		- autom. Nachstellung 1)	L=806
	1.8		08.83	07.92						
	1.6		08.83	12.93		24.3728-0121.2	590121		+ autom. Nachstellung 2)	L=800, + AUT
	1.6 D		08.83	07.92						
	1.6 TD	51	08.83	12.93						
	1.8		08.83	07.92						
	1.6 TD	59	04.89	12.93		24.3728-0120.2	590120			L=1081, + AUT
	1.8 G60		08.89	07.92		24.3728-0111.2	590111		- autom. Nachstellung 1)	L=806
	1.8 GTI 16V		02.86	07.92		24.3728-0121.2	590121		+ autom. Nachstellung 2)	L=800, + AUT
	1.8 Syncro		08.85	07.92						

VOLKSWAGEN JETTA I (79-83)

	1.1		08.79	07.83		03.2120-1531.3	010092			THz 20,64 ATE
	1.3		08.79	07.83		03.2120-1491.3	010089			THz 20,64 + WE ATE
	1.5		08.79	07.83						
	1.6		08.80	07.83						
	1.6		08.81	07.83	+ Ⓢ	03.2120-1491.3	010089			THz 20,64 + WE ATE
	1.6 D		08.80	07.81						
	1.6 i		08.79	07.82						
	1.6 TD		03.82	07.83						
	1.7		08.80	07.83	+ Ⓟ					
	1.8		08.82	07.83						
	1.6 D		08.81	07.83		03.2120-1531.3	010092			THz 20,64 ATE
						03.2120-1491.3	010089			THz 20,64 + WE ATE
	1.1		08.79	07.83		11.0441-4402.2	250014			Dichtungssatz ATE
	1.3		08.79	07.83						
	1.6 D		08.80	07.83	+ Schwimmsättel 3)					
	1.5		08.79	07.80	+ Schwimmsättel 3)	11.0441-4402.2	250014			Dichtungssatz ATE
	1.6		01.79	07.80	+ Schwimmsättel 3)					
	1.5		08.79	07.83	+ Faustsättel 4)	11.0441-4808.2	250022		f.Vornr -8007/8008 -8503/8504 5)	Dichtungssatz ATE
	1.6		08.80	07.83	+ Faustsättel 4)	11.0441-4804.2	250019			Dichts. (+Sich. Ring) ATE
	1.6 D		08.80	07.83	+ Faustsättel 4)	11.0101-4801.2	260006			Hülzensatz ATE
	1.6 i		08.79	07.82		24.0102-4801.2	260085			Hülzensatz+Schrauben ATE
	1.6 TD		03.82	07.83						
	1.7		08.80	07.83	+ Ⓟ					
	1.8		08.82	07.83						
	1.1		08.79	07.83		13.0460-4028.2	604028			20228 15,3 ATE
	1.3		08.79	07.83		13.0460-0115.2	610115			Belagsatz-Zubehör ATE
	1.6 D		08.80	07.83	+ Schwimmsättel/- Ⓟ 6)	13.0460-0905.2	610905			Belagsatz-Zubehör LUC
	1.5		08.79	07.80	+ Schwimmsättel 3)	13.0460-4029.2	604029			20228 18,5 ATE
	1.6		01.79	07.80	+ Schwimmsättel 3)					
	1.5		08.79	07.83	+ Faustsättel 4)	13.0460-7032.2	607032			20887 19,7 +/Zub VW
	1.6		08.80	07.83	+ Faustsättel 4)					
	1.6 D		08.80	07.83	+ Ⓟ / + Faustsättel 7)					
	1.6 TD		03.82	07.83						
	1.7		08.80	07.83	+ Ⓟ					
	1.6 i		08.79	07.82		13.0460-7033.2	607033			20887 15,3 +/Zub VW
	↓									

1) - automatic adjustment / - correzione automatica / - ajustage automatique / - reajuste automatico

2) + automatic adjustment / + correzione automatica / + ajustage automatique / + reajuste automático

3) + floating calipers / + pinze flottante / + étriers flottant / + pinzas flotante













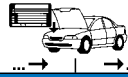





4) + fist type calipers / + pinza freno flottante / + étriers à griffe / + pinza de puno

5) f.partno.-8007/8008 -8503/8504 / p.no.codice -8007/8008 -8503/8504 / p.AV ref. -8007/8008 -8503/8504 / p.antes ref. -8007/8008 -8503/8504

6) + floating calipers/ - Ⓟ / + pinze flottante/ - Ⓟ / + étriers flottant/ - Ⓟ / + pinzas flotante/ - Ⓟ

7) + Ⓟ / + fist type calipers / + Ⓟ / + pinza flottante / + Ⓟ / + étriers à griffe / + Ⓟ / + pinza de puno



								
VOLKSWAGEN JETTA I (79-83)								
	1.8			08.82 07.83	13.0460-7033.2	607033		20887 15,3 +/Zub VW
	1.1			08.79 07.83	24.0110-0151.1	410151		239 10,0 8,0 +S +B
	1.3			08.79 07.83	24.0310-0151.1	510151		239 10,0 8,0 +S +B PD
	1.6 D			08.80 07.83 - (U)				
	1.5			08.79 07.83	24.0112-0106.1	412106		239 12,0 10,0 +S +B
	1.6			08.80 07.83	24.0312-0106.1	512106		239 12,0 10,0 +S +B PD
	1.6 D			08.80 07.83 + (U)				
	1.6 TD			03.82 07.83				
	1.7			08.80 07.83 + (U)				
	1.6 i			08.79 07.82	24.0120-0123.1	420123		239 20,0 18,0 V L +S +B
	1.8			08.82 07.83	24.0320-0123.1	520123		239 20,0 18,0 V L +S +B PD
	1.1			08.79 07.83	24.5170-0315.3	331309	2	L=315
	1.3			08.79 07.83	24.5108-0266.3	330038	2	L=266 LUC
	1.5			08.79 07.83				
	1.6			08.80 07.83				
	1.6 D			08.80 07.83				
	1.6 i			08.79 07.82				
	1.6 TD			03.82 07.83				
	1.7			08.80 07.83 + (U)				
	1.1			08.79 07.83	24.5201-0164.3	331414	2	L=164
	1.3			08.79 07.83				
	1.5			08.79 07.83				
	1.6			08.80 07.83				
	1.6 D			08.80 07.83				
	1.6 i			08.79 07.82				
	1.6 TD			03.82 07.83				
	1.7			08.80 07.83 + (U)				
	1.1			08.79 07.83	03.3214-0812.3	020011	+ GG ¹⁾	Rz 14,29
	1.3			08.79 07.83	24.3214-0902.3	020147	+ ALU ²⁾	Rz 14,29
	1.5			08.79 07.83 + Schaltgetriebe ³⁾				
	1.6			08.80 07.83 + Schaltgetriebe ³⁾				
	1.6 D			08.80 07.83 + Schaltgetriebe ³⁾				
	1.6 TD			03.82 07.83				
	1.5			08.79 07.83 + Automatikgetriebe ⁴⁾	03.3217-2112.3	020027	+ GG ¹⁾	Rz 17,46
	1.6			08.80 07.83 + Automatikgetriebe ⁴⁾	24.3217-0908.3	020167	+ ALU ²⁾	Rz 17,46
1.6 D			08.80 07.83 + Automatikgetriebe ⁴⁾					
1.6 i			08.79 07.82					
1.7			08.80 07.83 + (U)					
1.8			08.82 07.83					
	1.1			08.79 07.83	03.0137-0126.2	650126		180 x 31 HEB
	1.3			08.79 07.83	03.0137-9008.2	669008		Bremsbacken-Zubehör
	1.5			08.79 07.83				
	1.6			08.80 07.83				
	1.6 D			08.80 07.83				
	1.6 i			08.79 07.82				
	1.6 TD			03.82 07.83				
	1.7			08.80 07.83 + (U)				
1.8			08.82 07.83					
	1.1			08.79 07.83	24.0218-0007.1	480003		180/181 x 38,5 - Lager
	1.3			08.79 07.83	24.0218-0707.2	480211		180/181 x 38,5 + Lager
	1.5			08.79 07.83				
	1.6			08.80 07.83				
	1.6 D			08.80 07.83				
	1.6 i			08.79 07.82				
	1.6 TD			03.82 07.83				
	1.7			08.80 07.83 + (U)				
1.8			08.82 07.83					
	1.1			08.79 07.83	03.0520-0114.3	690114		14,29/180x31 TopKit VW
	1.3			08.79 07.83				
	1.5			08.79 07.83 + Schaltgetriebe ³⁾				
	1.6			08.80 07.83 + Schaltgetriebe ³⁾				
	1.6 D			08.80 07.83 + Schaltgetriebe ³⁾				
	1.6 TD			03.82 07.83				
	1.5			08.79 07.83 + Automatikgetriebe ⁴⁾	03.0420-0617.3	680617	+ Rz GG ⁵⁾	17,46/180x31 Kit VW
	1.6			08.80 07.83 + Automatikgetriebe ⁴⁾	03.0520-3917.3	693917	+ Rz ALU ⁶⁾	17,46/180x31 TopKit VW
1.6 D			08.80 07.83 + Automatikgetriebe ⁴⁾					
1.6 i			08.79 07.82					
1.7			08.80 07.83 + (U)					
1.8			08.82 07.83					
	1.1			08.79 07.83	24.3727-0102.2	580102	2 (U)	L=1690
	1.3			08.79 07.83				
	1.5			08.79 07.83				
	1.6			08.80 07.83				
	1.6 D			08.80 07.83				
	1.6 i			08.79 07.82				
	1.6 TD			03.82 07.83				
	1.7			08.80 07.83 + (U)				
1.8			08.82 07.83					

¹⁾ + cast iron / + ghisa / + fonte grise / + fundición de gris

²⁾ + aluminium / + alluminio / + aluminium / + aluminio

³⁾ + manual transmission / + scatola cambio velocità / + transmission mécanique / + cambio de velocidad

⁴⁾ + autom.transmission / + scatola cambio automatico / + transmission automatique / + cambio automático

⁵⁾ + WC cast iron / + CR ghisa / + CR fontgrise / + CR fundición de gris

⁶⁾ + WC aluminium / + CR alluminio / + CR aluminium / + CR aluminio

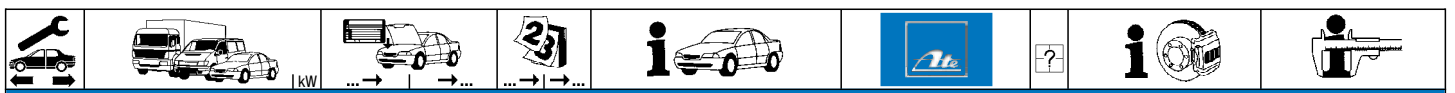

VOLKSWAGEN JETTA I (79-83)

	1.1			08.79	07.83		03.6565-0101.3	320097		BRL 6/5 (4)	ATE
	1.3			08.79	07.83						
	1.5			08.79	07.83						
	1.6			08.80	07.83						
	1.6 D			08.80	07.83						
	1.6 i			08.79	07.82						
	1.6 TD			03.82	07.83						
	1.7			08.80	07.83	+ ①					
1.8			08.82	07.83							
	1.1			08.79	07.83		24.3728-0107.2	590107		L=1055	
	1.3			08.79	07.83						
	1.5			08.79	07.83		24.3728-0108.2	590108		L=794	
	1.6			08.80	07.83						
	1.6 D			08.80	07.83						
	1.6 i			08.79	07.82						
	1.6 TD			03.82	07.83						
	1.7			08.80	07.83	+ ①					
1.8			08.82	07.83							

VOLKSWAGEN JETTA II (84-92)

	1.6			01.84	07.87	- ABS/ + Automatikgetriebe 1)	03.6750-0202.4	300033		9"	ATE
	1.6	51		10.86	07.92	- ABS					
	1.6	53		03.86	07.92	- ABS					
	1.6	55	1G-LW400000	01.84		- ABS					
	1.6	55	1G-LB125000	01.84		- ABS					
	1.6 D			01.84	07.89	- ABS/ + Automatikgetriebe 1)					
	1.6 TD			01.84	07.89	- ABS					
	1.8			01.84	07.89	- ABS					
	1.8 16V			01.84	07.89	- ABS					
	1.8 16V		1G-KW240000	08.86		- ABS					
	1.8 Syncro		1G-KB075000	08.86		- ABS					
			08.87	07.92	- ABS						
	1.6	55	1G-LW400001		07.92	- ABS	03.7750-4302.4	300076		9"	ATE
	1.6	55	1G-LB125001		07.92	- ABS					
	1.6 D			08.89	07.92	- ABS					
	1.6 TD			08.89	07.92	- ABS					
	1.8			08.89	07.92	- ABS					
	1.8 16V		1G-KW240001		07.92	- ABS					
	1.8 16V		1G-KB075001		07.92	- ABS					
	1.6			08.89	07.92	- ABS	03.7750-4902.4	300079		9"	ATE
	1.6 D			08.89	07.92	- ABS					
	1.6 TD			08.89	07.92	- ABS					
	1.8			08.89	07.92	- ABS					
1.8 16V		1G-KW240001		07.92	- ABS						
1.8 16V		1G-KB075001		07.92	- ABS						
	1.3			08.83	07.92	- ABS	03.2120-2031.3	010106		THz 20,64	ATE
	1.6			01.84	07.92	- ABS	03.3517-0101.2	390322		Verschlußschraube	
	1.6 D			01.84	07.89	- ABS					
	1.6 TD			01.84	07.89	- ABS					
	1.8			01.84	07.89	- ABS					
	1.8 16V		1G-KW240000	08.86		- ABS					
	1.8 16V		1G-KB075000	08.86		- ABS					
	1.8 Syncro			08.87	07.92	- ABS					
	1.6 D			08.89	07.92	- ABS	03.2120-3943.3	010532		THz 20,64	ATE
	1.6 TD			08.89	07.92	- ABS	03.3517-0101.2	390322		Verschlußschraube	
	1.8			08.89	07.92	- ABS					
1.8 16V		1G-KB075001		07.92	- ABS	03.2122-1042.3	010137		THz 22,20	ATE	
1.8 16V		1G-KW240001		07.92	- ABS	03.3517-0101.2	390322		Verschlußschraube		
	1.3			08.83	07.86		24.3481-1745.5	240277		D=48, - Halter	ATE
	1.3			08.83	07.86		24.3481-1746.5	240278		D=48, - Halter	ATE
	1.3			08.86	07.92	- ABS	11.0441-4808.2	250022		Dichtungssatz	ATE
	1.6 D		16-E-855000	01.84		- ①	11.0101-4803.2	260008		Hülsensatz	ATE
	1.6 D			01.84	07.86	- ①	24.0102-4803.2	260086		Hülsensatz+Schrauben	ATE
	1.6 D			08.86	07.92	+ Schaltgetriebe 2)					
	1.3		16-E-855001		07.86		11.0441-4808.2	250022		Dichtungssatz	ATE
	1.3			08.89	07.92	+ ABS	11.0101-4801.2	260006		Hülsensatz	ATE
	1.6			01.84	07.92		24.0102-4801.2	260085		Hülsensatz+Schrauben	ATE
	1.6 D		16-E-855001		07.86	- ①					
	1.6 D			01.84	07.86	+ ①					
1.6 D			08.86	07.92	+ Automatikgetriebe 3)						
1.6 TD			01.84	07.92							
1.8			01.84	07.92							
1.8 16V		1G-KW240000	08.86								
1.8 16V		1G-KB075000	08.86								
1.8 Syncro			08.87	07.92							
1.8 16V		1G-KW240001		07.92		24.3541-1609.5	240039		D=54, - Halter	LUC	
1.8 16V		1G-KB075001		07.92		24.3541-1610.5	240040		D=54, - Halter	LUC	
						24.0101-4301.2	260047		Bremssattel-Zubehör	LUC	
						11.0101-5403.2	260010		Faltenbalgsatz	LUC	
	1.3			08.83	07.86		13.0460-7030.2	607030		20889 17,3 /Zub	VW
	1.3			08.83	07.86	- ABS	13.0460-0184.2	610184		Belagsatz-Zubehör	VW
	1.3			03.86	07.86						
	1.6			01.84		- ①					
	1.6 D		16-E-855000	01.84		- ①					
	1.6 D			01.84	07.86	- ①					
	1.6 D			08.86	07.92	+ Schaltgetriebe 2)					
1.3		16-E-855001		07.86		13.0460-7032.2	607032		20887 19,7 +/Zub	VW	

1) - ABS/ + autom.transmission / - ABS/ + scatola cambio autom. / - ABS/ + transmission automatique / - ABS/ + cambio automático

2) + manual transmission / + scatola cambio velocità / + transmission mécanique / + cambio de velocidad

3) + autom.transmission / + scatola cambio automatico / + transmission automatique / + cambio automático



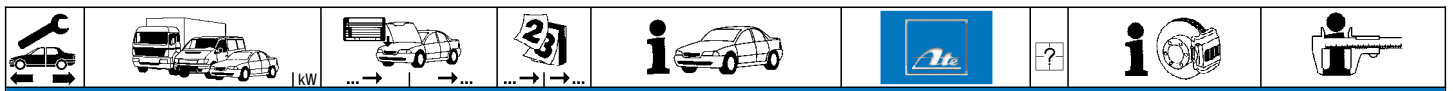















VOLKSWAGEN JETTA II (84-92)

	1.3			08.89	07.92	+ ABS	13.0460-7032.2	607032		20887	19,7 +/Zub	VW	
	1.6			08.86	07.92								
	1.6	55		01.84	07.86								
	1.6 D		16-E-855001		07.86	- ⊖							
	1.6 D			01.84	07.86	+ ⊕							
	1.6 D			08.86	07.87	+ Automatikgetriebe 1)							
	1.6 TD			01.84	07.92								
	1.8	62		08.86	07.92	- ABS							
	1.8	66		08.84	07.92	- ABS							
	1.8 Syncro			08.87	07.92								
	1.8	62	16-JH560001		07.92	+ ABS	13.0460-7033.2	607033		20887	15,3 +/Zub	VW	
	1.8	66	16-JH560001		07.92	+ ABS							
	1.8	77		08.88	07.92	+ ⊕							
	1.8	79		08.85	07.92								
	1.8	82		01.84	07.92								
	1.8 16V			1G-KW240000	08.86								
	1.8 16V			1G-KB075000	08.86								
	1.8 16V		1G-KW240001		07.92		13.0460-2957.2	602957		20168	16,0 /S	LUC	
	1.8 16V		1G-KB075001		07.92								
		1.3			16-E-855000	08.83		24.0110-0151.1	410151		239	10,0 8,0 +S +B	
1.3					08.83	07.86	24.0310-0151.1	510151		239	10,0 8,0 +S +B PD		
1.3					08.86	07.92	- ABS						
1.6		53		16-E-855000	03.86	07.86							
1.6 D					01.84	- ⊖							
1.6 D					01.84	07.86	- ⊖						
1.6 D					08.86	07.92	+ Schaltgetriebe 2)						
1.3			16-E-855001		07.86		24.0112-0106.1	412106		239	12,0 10,0 +S +B		
1.3					08.89	07.92	+ ABS	24.0312-0106.1	512106		239	12,0 10,0 +S +B PD	
1.6					08.86	07.92							
1.6	55			01.84	07.86								
1.6 D		16-E-855001		07.86	- ⊖								
1.6 D				01.84	07.86	+ ⊕							
1.6 D				08.86	07.92	+ Automatikgetriebe 1)							
1.6 TD				01.84	07.92								
1.8	62			08.86	07.92	- ABS							
1.8	66			08.84	07.92	- ABS							
1.8 Syncro				08.87	07.92								
	1.8	62	16-JH560001		07.92	+ ABS	24.0120-0123.1	420123		239	20,0 18,0 V L +S +B		
	1.8	66	16-JH560001		07.92	+ ABS	24.0320-0123.1	520123		239	20,0 18,0 V L +S +B PD		
	1.8	77		08.88	07.92	+ ⊕							
	1.8	79		08.85	07.92								
	1.8	82		01.84	07.92								
	1.8 16V			1G-KW240000	08.86								
	1.8 16V			1G-KB075000	08.86								
	1.8 16V		1G-KW240001		07.92	+ ABS	24.0120-0128.1	420128		256	20,0 18,0 V L +S +B		
	1.8 16V		1G-KB075001		07.92	+ ABS	24.0320-0128.1	520128		256	20,0 18,0 V L +S +B PD		
		1.3			1G-KW240000	08.83	07.92	24.5170-0315.3	331309	2		L=315	
1.6					01.84	07.92							
1.6 D					01.84	07.92							
1.6 TD					01.84	07.92							
1.8					01.84	07.92							
1.8 16V				1G-KW240000	02.86								
1.8 16V				1G-KB075000	02.86								
1.8 Syncro					08.87	07.92							
1.8 16V			1G-KW240001		07.92		83.6225-0287.3	330735	2		L=285		
1.8 16V			1G-KB075001		07.92								
	1.3				08.86	07.92	24.0711-1313.3	360016	2		Radsensor L=1130		
	1.6				08.86	07.92							
	1.6 D				08.86	07.92							
	1.6 TD				08.86	07.92							
	1.8				08.86	07.92							
	1.8 16V				08.86	07.92							
	1.8 Syncro				08.87	07.92							
	1.8				01.84	07.88	- ABS	24.3364-1605.5	240011		D=36, - Halter	LUC	
	1.8 16V				08.86	07.88	- ABS	24.3364-1606.5	240012		D=36, - Halter	LUC	
	1.8 GT				08.85	07.88	- ABS	24.0101-3601.2	260044		Bremssattel-Zubehör	LUC	
								11.0101-5403.2	260010		Faltenbalsatz	LUC	
	1.8	62	16-JH480001		07.88	+ ABS	24.3384-1603.5	240015		D=38, - Halter	LUC		
	1.8	66	16-JH480001		07.88	+ ABS	24.3384-1604.5	240016		D=38, - Halter	LUC		
	1.8	82	16-JH480001		07.88	+ ABS	24.0101-3601.2	260044		Bremssattel-Zubehör	LUC		
	1.8 16V		16-JH480001		07.88	+ ABS							
	1.8 GT		16-JH480001		07.88	+ ABS							
	1.8	62			08.88	07.89	+ ABS	24.3364-1605.5	240011		D=36, - Halter	LUC	
1.8	66			08.88	07.89	+ ABS	24.3364-1606.5	240012		D=36, - Halter	LUC		
1.8	82			08.88	07.89		24.0101-3601.2	260044		Bremssattel-Zubehör	LUC		
1.8 16V				08.88	07.89		11.0101-5403.2	260010		Faltenbalsatz	LUC		
1.8 GT				08.88	07.89								
	1.8	62			08.89	07.92	+ ABS	24.3384-1603.5	240015		D=38, - Halter	LUC	
	1.8	66			08.89	07.92	+ ABS	24.3384-1604.5	240016		D=38, - Halter	LUC	
	1.8	82			08.89	07.92		24.0101-3601.2	260044		Bremssattel-Zubehör	LUC	
	1.8 16V				08.89	07.92							
	1.8 GT				08.89	07.92							

1) + autom.transmission / + scatola cambio automatico / + transmission automatique / + cambio automático

2) + manual transmission / + scatola cambio velocità / + transmission mécanique / + cambio de velocidad

VOLKSWAGEN JETTA II (84-92)												
	1.8 1.8 1.8 1.8 16V 1.8 GT	62 66 82	16-JH480001 16-JH480001		07.92 07.92 01.84 08.86 08.85	+ ABS + ABS 07.92 07.92 07.92	13.0460-2937.2 13.0460-0419.2	602937 610419		20961 15,2 /Zub/S Belagsatz-Zubehör	LUC LUC	
	1.8 1.8 1.8 1.8 16V 1.8 GT	62 66 82	16-JH480001 16-JH480001		07.92 07.92 01.84 08.86 08.85	+ ABS + ABS 07.92 07.92 07.92	24.0110-0111.1 24.0110-0275.2	410111 410275		ohne Sensorring ¹⁾ mit Sensorring ²⁾	226 10,0 8,0 +B 226 10,0 8,0	
	1.3 1.6 1.6 D 1.6 TD 1.8 1.8				08.83 01.84 01.84 01.84 08.86 08.84	07.88 07.88 07.88 07.88 07.88 07.88	83.7824-0180.3 24.5201-0164.3	330812 331414	2 2		L=180 L=164	
	1.3 1.6 1.6 D 1.6 TD 1.8 1.8 1.8 Syncro				08.88 08.88 08.88 08.88 08.88 08.88 08.87	07.92 07.92 07.92 07.92 07.92 07.92 07.92	24.5201-0164.3	331414	2		L=164	
	1.8 1.8 1.8 1.8 16V	62 66 82	16-JH480001 16-JH480001		07.92 07.92 01.84 08.86	+ ABS + ABS 07.92 07.92	24.5170-0161.3	331308	2		L=161	
	1.3 1.6 1.6 D 1.6 TD 1.8 1.8 16V		1G-M-000001 1G-M-000001 1G-M-000001 1G-M-000001 1G-M-000001 1G-M-000001		07.92 07.92 07.92 07.92 07.92 07.92		24.0721-1925.1	360039	2		Radsensor L=1220	
	1.3 1.6 1.6 D 1.6 TD 1.8 1.8 1.8	62 66 77		1G-KW593279	08.83 01.84 01.84 01.84 08.86 08.84 08.88	07.92 07.92 07.92 07.92 07.92 07.92 + ⊕	03.3214-0812.3 24.3214-0902.3	020011 020147		+ GG ⁴⁾ + ALU ⁵⁾	Rz 14,29 Rz 14,29	
	1.3 1.6 1.6 D 1.6 TD 1.8 1.8 1.8	62 66 77		1G-KW593280	08.83 01.84 01.84 01.84 08.86 08.84 08.87	07.92 07.92 07.92 07.92 07.92 07.92 07.92	03.3217-2112.3 24.3217-0908.3	020027 020167		+ GG ⁴⁾ + ALU ⁵⁾	Rz 17,46 Rz 17,46	
	1.3 1.6 1.6 D 1.6 TD 1.8 1.8 1.8	62 66 77		1G-KW593279	08.83 01.84 01.84 01.84 08.86 08.84 08.88	07.92 07.92 07.92 07.92 07.92 07.92 + ⊕	03.0137-0126.2 03.0137-9008.2	650126 669008			180 x 31 HEB Bremsbacken-Zubehör	
	1.6 TD 1.8	77	1G-KW593280		08.89 07.92	+ ⊕ + ABS/ + ⊕	03.0137-0268.2 03.0137-9168.2	650268 669168			200 x 40 HEB Bremsbacken-Zubehör	VW VW
	1.3 1.6 1.6 D 1.6 TD 1.8 1.8 1.8	62 66 77		1G-KW593279	08.83 01.84 01.84 01.84 08.86 08.84 08.88	07.92 07.92 07.92 07.92 07.92 07.92 + ⊕	03.0137-0264.2 24.0218-0007.1 24.0218-0707.2	650264 480003 480211			230 x 40 HEB 180/181 x 38,5 - Lager 180/181 x 38,5 + Lager	VW
	1.6 TD 1.8	77	1G-KW593280		08.89 07.92	+ ⊕ + ⊕	24.0220-0018.1 24.0220-0718.2	480019 480209		ohne Sensorring ¹⁾ ohne Sensorring ¹⁾	200/201 x 50,5 - Lager 200/201,5 x 50,5 + Lager	VW
	1.3 1.6 1.6 D 1.6 TD 1.8 1.8	62 66			08.83 01.84 01.84 01.84 08.86 08.84	07.92 07.92 07.92 07.92 07.92 07.92	03.0520-0114.3	690114			14,29/180x31 TopKit	VW
	1.3 1.6 1.6 D 1.6 TD 1.8 1.8	62 66			08.83 01.84 01.84 01.84 08.86 08.84	07.92 07.92 07.92 07.92 07.92 07.92	03.0420-0617.3 03.0520-3917.3	680617 693917		+ Rz GG ⁹⁾ + Rz ALU ¹⁰⁾	17,46/180x31 Kit 17,46/180x31 TopKit	VW VW
	1.6 TD 1.8	77	1G-KW593280		08.89 07.92	+ ⊕ + ⊕	03.0420-1517.3 03.0520-1517.3	681517 691517			17,46/200x40 Kit 17,46/200x40 TopKit	VW VW

¹⁾ without sensor ring / senza sensori / sans secours ABS / sin anillo sensor ABS

²⁾ with sensor ring / con sensori / avec secours ABS / con anillo sensor ABS

³⁾ - brake pressure regulator / - correttore di frenata / - correcteur de freinage / - corrector de frenado

⁴⁾ + cast iron / + ghisa / + fonte grise / + fundición de gris

⁵⁾ + aluminium / + alluminio / + aluminium / + aluminio

⁶⁾ + brake pressure regulator / + correttore di frenata / + correcteur de freinage / + corrector de frenado

⁷⁾ - brake pressure regulator / - correttore di frenata / - correcteur de freinage / - corrector de frenado / - ⊕

⁸⁾ + brake pressure regulator/ - ⊕ / + correttore di frenata/ - ⊕ / + correcteur de freinage/ - ⊕ / + corrector de frenado/ - ⊕

⁹⁾ + WC cast iron / + CR ghisa / + CR fonte grise / + CR fundición de gris

¹⁰⁾ + WC aluminium / + CR alluminio / + CR aluminium / + CR aluminio

VOLKSWAGEN JETTA II (84-92)											
	1.3			08.83	07.88	24.3727-0118.2	580118	2	↓		L=1748
	1.6			01.84	07.88						
	1.6 D			01.84	07.88						
	1.6 TD			01.84	07.88						
	1.8	62		08.86	07.88					- ABS	
	1.8	66		08.84	07.88					- ABS	
	1.3			08.88	07.92	24.3727-0132.2	580132	2	↓		L=1527
	1.6			08.88	07.92						
	1.6 D			08.88	07.92						
	1.6 TD			08.88	07.92						
1.8	62		08.88	07.92						- ABS	
1.8	66		08.88	07.92						- ABS	
1.8	77		08.88	07.92						+ Ⓢ	
1.8	82		01.84	07.92	24.3727-0123.2	580123	2	↓		- ABS	L=1800
1.8 16V			08.86	07.92						- ABS	
1.8	82	16-JH480001		07.88	+ ABS	24.3727-0124.2	580124	2	↓		L=1840
1.8 16V		16-JH480001		07.88	+ ABS						
1.8	82		08.88	07.92	24.3727-0133.2	580133	2	↓		+ ABS	L=1622
1.8 16V			08.88	07.92						+ ABS	
1.8 Syncro			08.87	07.92	24.3727-0166.2	580166	2	↓			L=1567
	1.3			08.83	07.92	03.6584-0015.3	320109				BRL 8/4 (4) ATE
	1.6			01.84	07.92						
	1.6 D			01.84	07.92						
	1.6 TD			01.84	07.92						
	1.8			01.84	07.92						
	1.8 16V			08.86	07.92						
	1.8 Syncro			08.87	07.92						
	1.3			08.83	07.92	24.3728-0113.2	590113				L=1098
1.6			01.84	07.92	24.3728-0111.2	590111			- autom. Nachstellung ¹⁾	L=806	
1.8			01.84	07.92							
1.8 16V			08.86	07.92							
1.6 D			01.84	07.92	24.3728-0121.2	590121			+ autom. Nachstellung ²⁾	L=800, + AUT	
1.6 TD	51		01.84	07.92							
1.6 TD	59		04.89	07.92	24.3728-0120.2	590120				L=1081, + AUT	
1.8 Syncro			08.87	10.91	24.3728-0111.2	590111			- autom. Nachstellung ¹⁾	L=806	
					24.3728-0121.2	590121			+ autom. Nachstellung ²⁾	L=800, + AUT	
VOLKSWAGEN KÄFER (TYP 1) (49-03)											
	1200			01.54	07.64	03.3119-0507.3	010264				Hz 19,05 ATE
	1200			08.64	07.69	03.3117-1408.3	010255				Hz 17,46 ATE
	1300			08.65	07.67						
	1200			08.69	07.81	03.2119-8511.3	010062				THz 19,05 ATE
	1300			08.67	12.74	+ VA-Trommelbremse ³⁾					
	1500			08.67	12.70						
	1200			08.81	12.85	03.2119-8711.3	010064				THz 19,05 + WE ATE
	1300			08.67	12.74	+ VA-Scheibenbremse ⁴⁾	03.2119-8911.3	010066		- (USA)	THz 19,05 ATE
	1302			08.70	07.72	03.2119-9111.3	010068			+ (USA)	THz 19,05 + WE ATE
	1303			08.72	07.79						
1302			08.70	07.72	03.2119-9011.3	010067				THz 19,05 ATE	
1303			08.72	07.79							
1500			08.67	12.70	03.2119-8611.3	010063				THz 19,05 ATE	
	1300			01.65	01.73	13.2401-8007.2	210047				D=40 ATE
	1302			08.69	07.75	13.2401-8008.2	210048				D=40 ATE
	1500			08.66	11.73	13.0441-4002.2	250074				Dichtungssatz ATE
						13.0441-4008.2	250076				Dichtungssatz ATE
	1303			08.72	12.79	13.2401-8007.2	210047				D=40 ATE
					13.2401-8008.2	210048				D=40 ATE	
					13.0441-4002.2	250074				Dichtungssatz ATE	
					13.0441-4008.2	250076				Dichtungssatz ATE	
	1200	1122076274	1332013626			13.0460-3010.2	603010				20009 15,0 ATE
	1300	1122076274	1332013626			13.0460-0014.2	610014				Belagsatz-Zubehör ATE
	1302	1122076274	1332013626								
	1303			08.72	07.79	13.0460-2905.2	602905			für LUCAS-System ⁸⁾	20286 16,2 LUC
					13.0460-3010.2	603010			für ATE-System ⁹⁾	20009 15,0 ATE	
					13.0460-0908.2	610908				Belagsatz-Zubehör LUC	
	1200			01.54	12.77	24.0110-0142.1	410142				278 9,5 8,0
	1300			08.67	12.74						
	1302			08.70	07.72						
	1303			08.72	07.79						
	1500			08.66	12.70						
	1200			01.54	12.57	24.5165-0450.3	331259	2			L=450
	1200			01.57	07.64	83.6101-0240.3	330202	2			L=240
	1200			08.64	12.66	24.5165-0425.3	331258	2			L=425
	1300			08.65	07.66						
	1200			01.67	12.85	24.5165-0350.3	331257	2			L=350
	1300			08.66	07.67						
	1500			08.67	12.70						
	1300			08.67	12.74	83.6101-0325.3	330206	2			L=325
	1500			08.66	07.67						
	1302			08.70	07.72	24.5224-0295.3	331261	2			L=295
1303			08.72	07.73							
1303			08.73	07.79	24.5230-0285.3	331322	2			L=285	

¹⁾ - automatic adjustment / - correzione automatica / - ajustage automatique / - reajuste automatico

²⁾ + automatic adjustment / + correzione automatica / + ajustage automatique / + reajuste automatico

³⁾ + FA drum brake / + A freno a tamburo / + frein à tambour ess.AV / + ED tambores de freno

⁴⁾ + FA disc brake / + A disco freno / + frein à disque essieu AV / + ED disco de freno

⁵⁾ reuse up to 07.72 / riutilizzare fino a 07.72 / utiliser jusqu'au 07.72 / hasta 07.72 emplear

⁶⁾ reuse from 08.72 / utilizzare dal 08.72 / utiliser à partir de 08.72 / desde 08.72 emplear

⁷⁾ to change only by pairs / sostituire solo a coppie / à changer seulement par paires / cambiar solamente por parejas

⁸⁾ for LUCAS system / per sistema LUCAS / pour système LUCAS / para sistema LUCAS

⁹⁾ for ATE system / per sistema ATE / pour système ATE / para sistema ATE

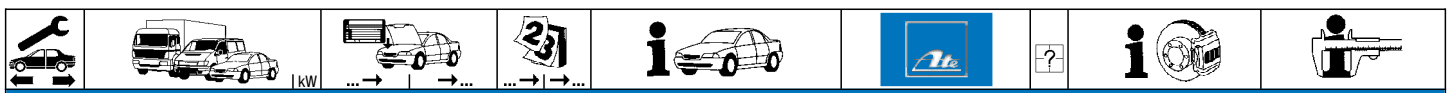

VOLKSWAGEN KÄFER (TYP 1) (49-03)

	1.1	18		12.47	12.53		03.3219-0102.3 03.0470-2619.2	020036 060051	03.3518-0200.2 mitverwenden 1)	Rz 19,05 Rz Dichtungssatz	
	1200			01.54	12.57		03.3219-0411.3 03.0470-2619.2	020038 060051		Rz 19,05 Rz Dichtungssatz	
	1200			01.57	07.64		03.3222-5211.3	020081		Rz 22,20	
	1200			08.64	12.85		03.3222-5211.3	020081		Rz 22,20	
	1300			08.65	12.74						
	1302			08.70	07.72		03.3223-0611.3	020091		Rz 23,81	
	1303			08.72	07.74						
	1200			01.68	12.85		03.0137-0041.2 03.0137-9229.2	650041 669229		230 x 40 Bremsbacken-Zubehör	ATE ATE
	1300			08.67	12.74						
	1302			08.70	07.72		03.0137-0073.2	650073		248 x 46 Bremsbacken-Zubehör	
	1303			08.72	07.74		03.0137-9009.2	669009			
	1200		118000001	01.68	12.85		24.0223-0002.1	480032		230/231 x 47	
	1300				12.74						
	1200			01.54	12.85	+ Schaltgetriebe 2)	24.5224-0240.3	331260	2	L=240	
	1300			08.65	12.74	+ Schaltgetriebe 2)					
	1500			08.66	12.70	+ Schaltgetriebe 2)					
	1200			08.69	12.77	+ Automatikgetriebe 3)	24.5165-0215.3	331319	2	L=215	
	1300			08.67	07.71	+ Automatikgetriebe 3)					
	1302			08.70	07.72						
	1303			08.72	07.79						
	1500			08.67	12.70	+ Automatikgetriebe 3)					
	1.1	18		12.47	12.53		03.3219-0102.3 03.0470-2619.2	020036 060051	03.3518-0200.2 mitverwenden 1)	Rz 19,05 Rz Dichtungssatz	
	1200			01.54	12.57		03.3217-0211.3	020021		Rz 17,46	
	1200			01.57	07.64		03.3219-3211.3	020048		Rz 19,05	
	1200			08.64	12.66		03.3219-3211.3	020048		Rz 19,05	
	1300			08.65	07.67						
	1500			08.66	07.67						
	1200			01.67	12.85		03.3217-1811.3	020026		Rz 17,46	
	1300			08.67	12.74						
	1302			08.70	07.72						
	1303			08.72	07.79						
	1500			08.67	12.70						
	1200			01.68	12.85		03.0137-0041.2 03.0137-9005.2	650041 669005		230 x 40 Bremsbacken-Zubehör	ATE
	1300			08.67	12.74						
	1302			08.70	07.72						
	1303			08.72	07.79						
	1500			08.66	12.70						
	1200			01.68	12.85		24.0223-0003.1	480033		230/231 x 50,5	
	1300			08.67	12.74						
	1302			08.70	07.72						
	1303			08.72	07.79						
	1600 i			10.93	08.03	+ ④					
	1200			01.67	12.85		03.0420-2917.3	682917		17,46/230x40 Kit	ATE
	1300			08.67	12.74						
	1302			08.70	07.72						
	1303			08.72	07.79						
	1500			08.67	12.70						
	1200		118210001		12.85		24.3727-0101.2	580101	2 ↓	L=1750	
	1303			08.72	07.79						
	1600 i			10.93	08.03	+ ④					
	1200		1122000001	1142663259			24.3728-0106.2	590106		L=2285	
	1300		1122000001		12.74						
	1302		1122000001		07.72						
	1303			1342663259	08.72						

VOLKSWAGEN LT/LT 4x4 (75-96)

	LT 28 LT 31 LT 35			04.75 04.75 04.75	07.96 07.96 07.96		03.6850-5402.4	300055		9"	ATE
						- Doppelbereifung 4)					
	LT 28 LT 31 LT 35			04.75 04.75 04.75	07.96 07.96 07.96	- ABS - ABS - ABS/ - Doppelbereifung 5)	03.2123-5212.3	010183		Thz 23,81	ATE
	LT 35 LT 40 LT 45 LT 50 LT 55			04.75 08.78 08.78 12.82 08.85	07.96 07.96 07.96 07.96 07.96	- ABS/ + Doppelbereifung 6) - ABS - ABS - ABS - ABS	03.2125-1712.3	010204		Thz 25,40	ATE
	LT 28 LT 31 LT 35			04.75 04.75 04.75	07.96 07.96 07.96		24.9257-8027.5 24.9257-8028.5 13.0441-5720.2	230039 230040 250122	 	D=57 D=57 Dichtungssatz	ATE ATE ATE
	LT 40 LT 45 LT 50 LT 55			08.78 08.78 12.82 08.85	07.96 07.96 07.96 07.96		13.9571-0041.2 13.9571-0042.2 24.9257-0041.5 24.9257-0042.5 13.0441-5720.2	210259 210260 230049 230050 250122	 	D=57 D=57 D=57 D=57 Dichtungssatz	ATE ATE ATE ATE ATE
	LT 28 LT 31 LT 35 LT 40			04.75 04.75 04.75 08.78	07.96 07.96 07.96 07.96		13.0460-5701.2 13.0460-0091.2	605701 610091		20392 18,5 /WE Belagsatz-Zubehör	ATE ATE

1) 03.3518-0200.2 reuse / 03.3518-0200.2 riutilizzare / 03.3518-0200.2 utiliser / 03.3518-0200.2 emplear
 2) + manual transmission / + scatola cambio velocità / + transmission mécanique / + cambio de velocidad
 3) + autom.transmission / + scatola cambio automatico / + transmission automatique / + cambio automático
 4) - twin tyres / - ruote gemellate / - roue jumelée / - cubierta doble
 5) - ABS/ - twin tyres / - ABS/ - ruote gemellate / - ABS/ - roue jumelée / - ABS/ - cubierta doble
 6) - ABS/ + twin tyres / - ABS/ + ruote gemellate / - ABS/ + roue jumelée / - ABS/ + cubierta doble

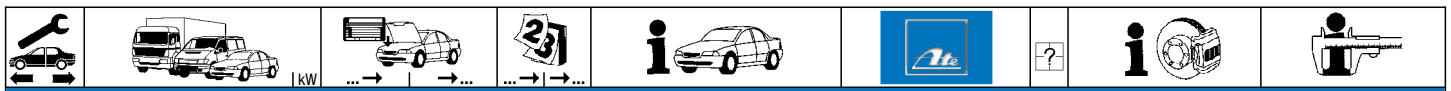

























VOLKSWAGEN LT/LT 4x4 (75-96)

	LT 45 LT 50 LT 55			08.78 12.82 08.85	07.96 07.96 07.96	13.0460-5701.2 13.0460-0091.2	605701 610091			20392 18,5 /WE Belagsatz-Zubehör	ATE ATE
	LT 28 LT 28 LT 28 LT 31 LT 31 LT 31 LT 35 LT 40 LT 45 LT 50 LT 55	▶ ▶ ▶ ▶ ▶ ▶ ▶ ▶ ▶ ▶ ▶	28-B-018541 28-B-019163 28-D-007274 28-B-018541 28-B-019163 28-D-007274 28-B-012411 28-B-012411 28-B-012411	28-D-007273 28-D-007273 28-D-007273 28-D-007273 12.82 08.85	07.96 07.96 07.96 07.96 07.96 07.96 07.96 07.96 07.96	24.0120-0114.2	420114			281 19,9 18,0 +B	
	LT 28 LT 31 LT 35			04.75 04.75 04.75	07.96 07.96 07.96	24.5224-0299.3	331262	2		L=300	
	LT 40 LT 45 LT 50 LT 55			08.78 08.78 12.82 08.85	07.96 07.96 07.96 07.96	24.5224-0440.3	331378	2		L=445	
	LT 28 LT 31 LT 35 LT 40 LT 45			28-D-007273 28-D-007273 28-D-007273 28-D-007273 28-D-007273	04.75 04.75 04.75 08.78 08.78	83.6301-0355.3	330343	2		L=355	
	LT 28 LT 31 LT 35 LT 40 LT 45 LT 50 LT 55	▶ ▶ ▶ ▶ ▶ ▶ ▶	28-D-007274 28-D-007274 28-D-007274 28-D-007274 28-D-007274	04.75 04.75 04.75 08.78 08.78 12.82 08.85	07.96 07.96 07.96 07.96 07.96 07.96 07.96	83.6124-0362.3	330715	1		L=360	
	LT 28 LT 31 LT 35 LT 40 LT 45 LT 50 LT 55			04.75 04.75 04.75 08.78 08.78 12.82 08.85	07.96 07.96 07.96 07.96 07.96 07.96 07.96	83.7724-0467.3	331274	1	PR: 1X1 PR: 1X1 PR: 1X1 PR: 1X1 PR: 1X1	L=465	
	LT 28 LT 31 LT 35			04.75 04.75 04.75	07.96 07.96 07.96	03.3225-5511.3	020102			Rz 25,40	
	LT 35 LT 35 LT 40 LT 45 LT 50 LT 55	▶ ▶ ▶ ▶ ▶ ▶	29-M-009907	04.75 07.96 08.78 08.78 12.82 08.85	10.90 07.96 07.96 07.96 07.96 07.96	03.3225-5512.3	020103		- Doppelbereifung ¹⁾ + Doppelbereifung ²⁾ - Radstand 3650 mm ³⁾ - Radstand 3650 mm ³⁾ - Radstand 3650 mm ³⁾ - Radstand 3650 mm ³⁾	Rz 25,40	
	LT 40 LT 45 LT 50 LT 55			08.78 08.78 12.82 08.85	07.96 07.96 07.96 07.96	24.3226-0901.3	020295		+ Radstand 3650 mm ⁴⁾ + Radstand 3650 mm ⁴⁾ + Radstand 3650 mm ⁴⁾ + Radstand 3650 mm ⁴⁾	Rz 26,99	
	LT 28 LT 31			28-A0020471 28-A0020471	04.75 04.75	03.0137-9151.2	669151			Bremsbacken-Zubehör	
	LT 28 LT 31 LT 35	▶ ▶ ▶	28-A0020472 28-A0020472	04.75 04.75	07.96 07.96	03.0137-0259.2 03.0137-9159.2	650259 669159			252 x 56 HEB Bremsbacken-Zubehör	
	LT 35 LT 40 LT 45 LT 50 LT 55	▶ ▶ ▶ ▶ ▶	28-D-007274 28-D-007274 28-D-007274	04.75 07.96 07.96 12.82 08.85	07.96 07.96 07.96 07.96 07.96	03.0137-0252.2 03.0137-9152.2	650252 669152			270 x 66 HEB Bremsbacken-Zubehör	
	LT 28 LT 31 LT 35			04.75 04.75 04.75	07.96 07.96 07.96	24.0225-2003.1	480047			252/253,5 x 66	
	LT 35 LT 40 LT 45 LT 50 LT 55			04.75 08.78 08.78 12.82 08.85	07.96 07.96 07.96 07.96 07.96	24.0227-0001.1	480052			270/271,5 x 71	
	LT 28 LT 31 LT 28 LT 31 LT 28 LT 31 LT 35	▶ ▶ ▶ ▶ ▶ ▶ ▶	28-D-007246 28-D-007246 28-D-007246 28-D-007246 28-D-007247 28-D-007247 29-G-014001	04.75 04.75 04.75 04.75 07.96 07.96 07.96	07.96 07.96 07.96 07.96 07.96 07.96 07.96	24.3727-0112.2 24.3727-0113.2 24.3727-0113.2 24.3727-0112.2 24.3727-0112.2 24.3727-0113.2 24.3727-0112.2 24.3727-0113.2	580112 580113 580113 580112 580112 580113 580112 580113		L=1042 L=1690 L=1690 L=1042 L=1042 L=1690 L=1042 L=1690		
	LT 50 LT 55		29-G-014001	08.85	07.96	24.3727-0120.2	580120	2	+ Einfachbereifung ⁵⁾	L=1400	

1) - twin tyres / - ruote gemellate / - roue jumelée / - cubierta doble
 2) + twin tyres / + ruote gemellate / + roue jumelée / + cubierta doble
 3) - wheel base 3650mm / - passo 3650mm / - empattement 3650mm / - distancia entre ejes 3650mm
 4) + wheel base 3650 mm / + passo 3650 mm / + empattement 3650 mm / + distancia entre ejes 3650 mm
 5) + single tyre / + ruota singola / + roue simple / + cubierta simple



											
VOLKSWAGEN LT/LT 4x4 (75-96)											
	LT 28	◀	28-D-007274		07.96	24.3728-0126.2	590126	L=1819			
	LT 31	◀	28-D-007274		07.96						
	LT 35	◀	28-D-007274		07.96						
	LT 40	◀	28-D-007274		07.96						
	LT 45	◀	28-D-007274		07.96						
	LT 50	◀		12.82	07.96						
	LT 55	◀		08.85	07.96						
VOLKSWAGEN PASSAT Limousine (85-88)											
	1.3	◀			08.84	07.86	03.7750-0302.4	300071	9"	ATE	
	1.6	◀			08.84	03.88					
	1.6 D	◀			08.84	03.88					
	1.6 TD	◀			08.84	03.88					
	1.8	◀			08.84	03.88					
	2.0	◀			08.84	03.88					
	2.2	◀			08.85	03.88					
	2.2	◀100			01.85	03.88	03.2122-9612.3	010159	THz 22,20	ATE	
	1.3	▶			08.84	07.86	03.2120-2331.3	010110	THz 20,64	ATE	
	1.6	▶			08.84	03.88					
	1.6 D	▶			08.84	03.88					
	1.6 TD	▶			08.84	03.88					
	1.8	▶			08.84	03.88					
	2.0	▶			08.84	03.88					
	2.2	▶85			08.85	03.88					
	1.3				08.84	07.86	11.0441-4808.2	250022		Dichtungssatz	ATE
	1.6				08.84	03.88	11.0101-4801.2	260006		Hülsensatz	ATE
	1.6 D				08.84	03.88	24.0102-4801.2	260085		Hülsensatz+Schrauben	ATE
	1.6 TD				08.84	03.88					
	1.8				08.84	03.88					
	2.0				08.84	03.88					
	2.2	85			08.85	03.88					
	2.2	100			01.85	03.88	24.3541-1610.5	240040		D=54, - Halter	LUC
							24.3541-1609.5	240039		D=54, - Halter	LUC
							24.0101-4301.2	260047		Bremssattel-Zubehör	LUC
							11.0101-5403.2	260010		Faltenbalgsatz	LUC
	1.3				08.84	07.86	13.0460-7032.2	607032		20887 19,7 +/Zub	VW
	1.6				08.84	03.88					
	1.6 D				08.84	03.88					
	1.6 TD				08.84	03.88					
	1.8				08.84	03.88					
	2.0				08.84	03.88					
	2.2	85			08.85	03.88	13.0460-7033.2	607033		20887 15,3 +/Zub	VW
	2.2	100			01.85	03.88	13.0460-2957.2	602957		20168 16,0 /S	LUC
	1.3				08.84	07.86	24.0112-0106.1	412106		239 12,0 10,0 +S +B	
	1.6				08.84	03.88	24.0312-0106.1	512106		239 12,0 10,0 +S +B PD	
	1.6 D				08.84	03.88					
	1.6 TD				08.84	03.88					
	1.8				08.84	03.88					
	2.0				08.84	03.88	24.0120-0123.1	420123		239 20,0 18,0 V L +S +B	
	2.2	85			08.85	03.88	24.0320-0123.1	520123		239 20,0 18,0 V L +S +B PD	
	2.2	100			01.85	03.88	24.0120-0128.1	420128		256 20,0 18,0 V L +S +B	
							24.0320-0128.1	520128		256 20,0 18,0 V L +S +B PD	
	1.3				08.84	07.86	24.5170-0315.3	331309	2	L=315	
	1.6				08.84	03.88					
	1.6 D				08.84	03.88					
	1.6 TD				08.84	03.88					
	1.8				08.84	03.88					
	2.0				08.84	03.88					
	2.2				08.85	03.88					
	2.2	100			01.85	03.88	24.3364-1605.5	240011		D=36, - Halter	LUC
							24.3364-1606.5	240012		D=36, - Halter	LUC
							24.0101-3601.2	260044		Bremssattel-Zubehör	LUC
							11.0101-5403.2	260010		Faltenbalgsatz	LUC
	2.2	100			01.85	03.88	13.0460-2937.2	602937		20961 15,2 /Zub/S	LUC
							13.0460-0419.2	610419		Belagsatz-Zubehör	LUC
	2.2	100			01.85	03.88	24.0110-0111.1	410111		226 10,0 8,0 +B	
							24.0110-0275.2	410275	ohne Sensorring ¹⁾ mit Sensorring ²⁾	226 10,0 8,0	
	1.3				08.84	07.86	24.5201-0164.3	331414	2	L=164	
	1.6				08.84	03.88					
	1.6 D				08.84	03.88					
	1.6 TD				08.84	03.88					
	1.8				08.84	03.88					
	1.6				08.84	03.88					
	1.6 D				08.84	03.88	83.7824-0180.3	330812		L=180	
	1.6 TD				08.84	03.88	24.5201-0164.3	331414		L=164	
	1.8				08.84	03.88					
	2.0				08.84	03.88					
	2.2	85			08.85	03.88					
	2.2	100			01.85	03.88					
							24.5170-0161.3	331308	2	L=161	

¹⁾ without sensor ring / senza sensori / sans secours ABS / sin anillo sensor ABS

²⁾ with sensor ring / con sensori / avec secours ABS / con anillo sensor ABS

³⁾ + manual transmission / + scatola cambio velocità / + transmission mécanique / + cambio de velocidad

⁴⁾ + autom.transmission / + scatola cambio automatico / + transmission automatique / + cambio automático

VOLKSWAGEN PASSAT Limousine (85-88)									
	1.3		08.84	07.86	- verstärkte Bremse ¹⁾	03.3215-2311.3	020018	+ GG ²⁾	Rz 15,87
	1.6		08.84	03.88	- verstärkte Br./+ Schaltgetr. ⁴⁾	24.3215-0903.3	020154	+ ALU ³⁾	Rz 15,87
	1.8		08.84	03.88	- verstärkte Br./+ Schaltgetr. ⁴⁾				
	1.6 D		08.84	03.88	- verstärkte Br./+ Schaltgetr. ⁴⁾	03.3214-0812.3	020011	+ GG ²⁾	Rz 14,29
						24.3214-0902.3	020147	+ ALU ³⁾	Rz 14,29
	1.3		08.84	07.86	+ verstärkte Bremse ⁵⁾	03.3217-2112.3	020027	+ GG ²⁾	Rz 17,46
	1.6		08.84	03.88	+ verstärkte Bremse/+ Schaltgetr. ⁶⁾	24.3217-0908.3	020167	+ ALU ³⁾	Rz 17,46
	1.6		08.84	03.88	+ Automatikgetriebe ⁷⁾				
	1.6 D		08.84	03.88	+ verstärkte Bremse/+ Schaltgetr. ⁶⁾				
	1.6 D		08.84	03.88	+ Automatikgetriebe ⁷⁾				
1.6 TD		08.84	03.88						
1.8		08.84	03.88	+ verstärkte Bremse/+ Schaltgetr. ⁶⁾					
1.8		08.84	03.88	+ Automatikgetriebe ⁷⁾					
2.0		08.84	03.88						
2.2	85	08.85	03.88						
	1.3		08.84	07.86	- verstärkte Bremse ¹⁾	03.0137-0126.2	650126		180 x 31 HEB
	1.6		08.84	03.88	- verstärkte Br./+ Schaltgetr. ⁴⁾	03.0137-9008.2	669008		Bremsbacken-Zubehör
	1.6 D		08.84	03.88	- verstärkte Br./+ Schaltgetr. ⁴⁾				
	1.8		08.84	03.88	- verstärkte Br./+ Schaltgetr. ⁴⁾				
	1.3		08.84	07.86	+ verstärkte Bremse ⁵⁾	03.0137-0146.2	650146		200 x 40 HEB
	1.6		08.84	03.88	+ verstärkte Bremse/+ Schaltgetr. ⁶⁾	03.0137-9041.2	669041		Bremsbacken-Zubehör
	1.6		08.84	03.88	+ Automatikgetriebe ⁷⁾				
	1.6 D		08.84	03.88	+ verstärkte Bremse/+ Schaltgetr. ⁶⁾				
	1.6 D		08.84	03.88	+ Automatikgetriebe ⁷⁾				
	1.6 TD		08.84	03.88					
1.8		08.84	03.88	+ verstärkte Bremse/+ Schaltgetr. ⁶⁾					
1.8		08.84	03.88	+ Automatikgetriebe ⁷⁾					
2.0		08.84	03.88						
2.2	85	08.85	03.88						
	1.3		08.84	07.86	- verstärkte Bremse ¹⁾	24.0218-0007.1	480003		180/181 x 38,5 - Lager
	1.6		08.84	03.88	- verstärkte Br./+ Schaltgetr. ⁴⁾	24.0218-0707.2	480211		180/181 x 38,5 + Lager
	1.6 D		08.84	03.88	- verstärkte Br./+ Schaltgetr. ⁴⁾				
	1.8		08.84	03.88	- verstärkte Br./+ Schaltgetr. ⁴⁾				
	1.3		08.84	07.86	+ verstärkte Bremse ⁵⁾	24.0220-0018.1	480019	ohne Sensorring ⁸⁾	200/201 x 50,5 - Lager
	1.6		08.84	03.88	+ verstärkte Bremse/+ Schaltgetr. ⁶⁾	24.0220-0718.2	480209	ohne Sensorring ⁸⁾	200/201,5 x 50,5 + Lager
	1.6		08.84	03.88	+ Automatikgetriebe ⁷⁾				
	1.6 D		08.84	03.88	+ verstärkte Bremse/+ Schaltgetr. ⁶⁾				
	1.6 D		08.84	03.88	+ Automatikgetriebe ⁷⁾				
	1.6 TD		08.84	03.88					
1.8		08.84	03.88	+ verstärkte Bremse/+ Schaltgetr. ⁶⁾					
1.8		08.84	03.88	+ Automatikgetriebe ⁷⁾					
2.0		08.84	03.88						
2.2	85	08.85	03.88						
	1.3		08.84	07.86	- verstärkte Bremse ¹⁾	03.0520-0215.3	690215		15,87/180x31 TopKit
	1.6		08.84	03.88	- verstärkte Br./+ Schaltgetr. ⁴⁾				WV
	1.8		08.84	03.88	- verstärkte Br./+ Schaltgetr. ⁴⁾				
	1.6 D		08.84	03.88	- verstärkte Br./+ Schaltgetr. ⁴⁾	03.0520-0114.3	690114		14,29/180x31 TopKit
									WV
	1.3		08.84	07.86	+ verstärkte Bremse ⁵⁾	03.0420-0417.3	680417		17,46/200x40 Kit
	1.6		08.84	03.88	+ verstärkte Bremse/+ Schaltgetr. ⁶⁾				
	1.6		08.84	03.88	+ Automatikgetriebe ⁷⁾				
	1.6 D		08.84	03.88	+ verstärkte Bremse/+ Schaltgetr. ⁶⁾				
	1.6 D		08.84	03.88	+ Automatikgetriebe ⁷⁾				
1.6 TD		08.84	03.88						
1.8		08.84	03.88	+ verstärkte Bremse/+ Schaltgetr. ⁶⁾					
1.8		08.84	03.88	+ Automatikgetriebe ⁷⁾					
2.0		08.84	03.88						
2.2	85	08.85	03.88						
	1.3		08.84	07.86		24.3727-0108.2	580108	1 ↓	L=2565
	1.6		08.84	03.88					
	1.6 D		08.84	03.88					
	1.6 TD		08.84	03.88					
	1.8		08.84	03.88					
	2.0		08.84	03.88					
2.2	85	08.85	03.88						
	2.0		08.84	03.88		03.2419-8150.3	030019		Gz 19,05
	2.2		08.85	03.88					
	2.0		08.84	03.88		03.2522-4211.3	040017		Nz 22,20
	2.2		08.85	03.88					
	1.3		08.84	07.86		24.3728-0114.2	590114		L=944
	1.6		08.84	03.88					
	1.8		08.84	03.88					
VOLKSWAGEN PASSAT Variant (73-84)									
	1.3		08.81	07.84		03.2120-2331.3	010110		Thz 20,64
	1.6		10.82	07.84					ATE
	1.6 D		02.79	07.84					
	1.6 TD		12.81	07.84					
	1.8 i		08.83	07.84					
	1.9		01.81	07.83					
2.0		08.83	07.84						

¹⁾ - heavy duty brake / - freno reforzado / - frein renforcé / - freno reforzado

²⁾ + cast iron / + ghisa / + fonte grise / + fundición de gris

³⁾ + aluminium / + alluminio / + aluminium / + aluminio

⁴⁾ - heavy duty br./+ manual trans. / - fr.rinforzato/+ scatola camb.velocità / - frein renforcé / + transm.mécanique / - freno reforzado/ + camb.velocidad

⁵⁾ + heavy duty brake / + freno reforzado / + frein renforcé / + freno reforzado

⁶⁾ + heavy duty br./+manual transm. / + fr.rinforzato/+ scatola camb.velocità / + frein renforcé / + transm.mécanique / + freno reforzado/ + camb.de velocidad

⁷⁾ + autom.transmission / + scatola cambio automatico / + transmission automatique / + cambio automático

⁸⁾ without sensor ring / senza sensori / sans secours ABS / sin anillo sensor ABS

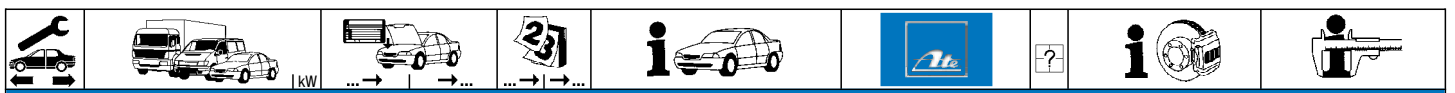

VOLKSWAGEN PASSAT Variant (73-84)

	1.3 1.5 1.6 1.6 i		05.73 07.77 05.73 08.75 09.75 07.77 06.78 07.80 + S J	03.3508-7504.3	310045		ohne Warneinrichtung ⁸⁾	Behälter	ATE
	1.3 1.5 1.5 D 1.6 1.6 1.6 i		05.73 01.80 05.73 08.75 08.77 01.80 + Schwimmsättel ¹⁾ 09.75 07.78 08.78 01.80 + Schaltgetriebe ²⁾ 06.78 01.80 + S J / + Schwimmsättel ³⁾	11.0441-4402.2	250014			Dichtungssatz	ATE
	1.3 1.5 D 1.6 1.6 D 1.6 i 1.6 TD 1.8 1.9 2.0 2.2		02.80 11.83 02.80 07.80 + Faustsättel ⁴⁾ 02.80 11.83 02.79 11.83 06.78 07.80 + S J / + Faustsättel ⁵⁾ 12.81 11.83 01.83 11.83 01.81 07.83 08.83 11.83 01.81 07.83 + S	11.0441-4808.2 11.0101-4801.2 24.0102-4801.2	250022 260006 260085			Dichtungssatz Hülsensatz Hülsensatz+Schrauben	ATE ATE ATE
	1.3 1.6 1.6 D 1.6 TD 1.8 2.0		12.83 07.84 12.83 07.84 12.83 07.84 12.83 07.84 12.83 07.84	11.0441-4808.2 11.0101-4801.2 24.0102-4801.2	250022 260006 260085			Dichtungssatz Hülsensatz Hülsensatz+Schrauben	ATE ATE ATE
	1.3 1.5 1.5 D 1.6 1.6 1.6 i		05.73 01.80 05.73 08.75 08.77 01.80 + Schwimmsättel ¹⁾ 09.75 07.78 08.78 01.80 + Schaltgetriebe ²⁾ 06.78 01.80 + S J / + Schwimmsättel ³⁾	13.0460-4029.2	604029			20228 18,5	ATE
	1.3 1.5 D 1.6 1.6 D 1.6 i 1.6 TD 1.8		02.80 07.84 02.80 07.80 + Faustsättel ⁴⁾ 02.80 07.84 02.79 07.84 02.80 07.80 + S J / + Faustsättel ⁵⁾ 12.81 07.84 01.83 07.84	13.0460-7032.2	607032			20887 19,7 +/Zub	VW
	1.8 i 1.9 2.0 2.2		12.83 07.84 01.81 07.83 08.83 07.84 01.81 07.83 + S	13.0460-7033.2	607033			20887 15,3 +/Zub	VW
	1.3 1.5 1.5 D 1.6 1.6 D 1.6 i 1.6 TD 1.8		05.73 07.84 05.73 08.75 08.77 07.80 09.75 07.84 02.79 07.84 06.78 07.80 + S J 12.81 07.84 01.83 07.84	24.0112-0106.1 24.0312-0106.1	412106 512106			239 12,0 10,0 +S +B 239 12,0 10,0 +S +B PD	
	1.8 i 1.9 2.0 2.2		12.83 07.84 01.81 07.83 08.83 07.84 01.81 07.83 + S	24.0120-0123.1 24.0320-0123.1	420123 520123			239 20,0 18,0 V L +S +B 239 20,0 18,0 V L +S +B PD	
	1.3 1.5 1.5 D 1.6 1.6 D 1.6 i 1.6 TD 1.8 1.9 2.0 2.2		05.73 07.84 05.73 08.75 08.77 07.80 09.75 07.84 02.79 07.84 06.78 07.80 + S J 12.81 07.84 01.83 07.84 01.81 07.83 08.83 07.84 01.81 07.83 + S	24.5170-0315.3 24.5108-0266.3	331309 330038	2 2		L=315 L=266	LUC
	1.3 1.5 1.5 D 1.6 1.6 i		05.73 07.80 05.73 08.75 08.77 07.80 09.75 07.80 06.78 07.80 + S J	83.7824-0180.3	330812	2		L=180	
	1.3 1.6 1.6 D 1.6 TD 1.9 2.0 2.2		08.80 07.84 08.80 07.84 02.79 07.84 12.81 07.84 01.81 07.83 08.83 07.84 01.81 07.83 + S	83.7824-0180.3 24.5201-0164.3	330812 331414			L=180 L=164	
	1.9 2.2		01.81 07.81 01.81 07.81 + S	03.3215-2311.3 24.3215-0903.3	020018 020154		+ GG ⁶⁾ + ALU ⁷⁾	Rz 15,87 Rz 15,87	
	1.3 1.5 1.5 D 1.6 1.6 D		05.73 07.84 05.73 08.75 08.77 07.80 09.75 07.84 02.79 07.84	03.3217-2112.3 24.3217-0908.3	020027 020167		+ GG ⁶⁾ + ALU ⁷⁾	Rz 17,46 Rz 17,46	

1) + floating calipers / + pinze flottante / + étriers flottant / + pinzas flotante
 2) + manual transmission / + scatola cambio velocità / + transmission mécanique / + cambio de velocidad
 3) + S J / + floating calipers / + S J / + pinze flottanti / + S J / + étriers flottant / + S J / + pinza flotante
 4) + fist type calipers / + pinza freno flotante / + étriers à griffe / + pinza de puno
 5) + S J / + fist type caliper / + S J / + pinza flotante / + S J / + étriers à griffe / + S J / + pinza de puno
 6) + cast iron / + ghisa / + fonte grise / + fundición de gris
 7) + aluminium / + alluminio / + aluminium / + aluminio

8) without alarm / senza dispositivo d'allarme / sans dispositif d'avertissement / sin dispositivo avisador



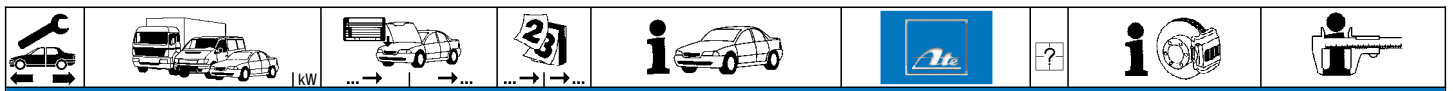

VOLKSWAGEN PASSAT Variant (73-84)



























	1.6 i 1.6 TD 1.8 1.9 2.0 2.2			06.78 12.81 01.83 08.81 08.83 08.81	07.80 07.84 07.84 07.83 07.84 07.83	+ S J + S	03.3217-2112.3 24.3217-0908.3	020027 020167	+ GG ¹⁾ + ALU ²⁾	Rz 17,46 Rz 17,46
	1.3 1.5 D 1.6 1.6 D 1.6 i 1.6 TD 1.8 1.9 2.0 2.2			08.78 08.78 08.78 02.79 08.78 12.81 01.83 08.81 08.83 01.81	07.84 07.80 07.84 07.84 07.80 07.84 07.84 07.83 07.84 07.83	 + S J + S	03.0137-0146.2 03.0137-9041.2	650146 669041		200 x 40 HEB Bremsbacken-Zubehör
	1.3 1.5 1.5 D 1.6 1.6 D 1.6 i 1.6 TD 1.8 1.9 2.0 2.2			05.73 05.73 08.77 09.75 02.79 06.78 12.81 01.83 01.81 08.83 01.81	07.84 08.75 07.80 07.84 07.84 07.80 07.84 07.84 07.83 07.84 07.83	 + S J + S	24.0220-0018.1 24.0220-0718.2	480019 480209	ohne Sensorring ³⁾ ohne Sensorring ³⁾	200/201 x 50,5 - Lager 200/201,5 x 50,5 + Lager
	1.3 1.5 D 1.6 1.6 D 1.6 i 1.6 TD 1.8 1.9 2.0 2.2			08.78 08.78 08.78 02.79 06.78 12.81 01.83 08.81 08.83 08.81	07.84 07.80 07.84 07.84 07.80 07.84 07.84 07.83 07.84 07.83	 + S J + S	03.0420-0417.3	680417		17,46/200x40 Kit VW
	1.3 1.6 1.6 D 1.6 TD 1.8 1.9 2.0 2.2			08.80 08.80 02.79 12.81 01.83 01.81 08.83 01.81	07.84 07.84 07.84 07.84 07.84 07.83 07.84 07.83	 + S	24.3727-0108.2	580108	1	L=2565
	1.3 1.5 1.5 D 1.6 1.6 i	32-42143626 32-42143626 32-42143626 32-42143626 32-42143626			07.80 08.75 07.80 07.80 07.80	 + S J	03.6565-0101.3	320097		BRL 6/5 (4) ATE
	1.3 1.6 1.8			08.83 08.83 08.83	07.84 07.84 07.84	 66	24.3728-0114.2	590114		L=944

VOLKSWAGEN PASSAT Variant (85-88)

	1.3 1.6 1.6 D 1.6 TD 1.8 2.0 2.2			08.84 08.84 08.84 08.84 08.84 08.84 08.85	07.86 03.88 03.88 03.88 03.88 03.88 03.88		03.7750-0302.4	300071		9" ATE
	1.3 1.6 1.6 D 1.6 TD 1.8 2.0 2.2			08.84 08.84 08.84 08.84 08.84 08.84 08.85	07.86 03.88 03.88 03.88 03.88 03.88 03.88		03.2120-2331.3	010110		Thz 20,64 ATE
	1.3 1.6 1.6 D 1.6 TD 1.8 2.0 2.2			08.84 08.84 08.84 08.84 08.84 08.84 08.85	07.86 03.88 03.88 03.88 03.88 03.88 03.88		11.0441-4808.2 11.0101-4801.2 24.0102-4801.2	250022 260006 260085		Dichtungssatz ATE Hülsensatz ATE Hülsensatz+Schrauben ATE
	1.8 Syncro 2.0 Syncro 2.2 2.2 Syncro	85 100		01.86 08.84 01.85 08.84	07.88 07.88 03.88 07.88		24.3541-1610.5 24.3541-1609.5 24.0101-4301.2 11.0101-5403.2	240040 240039 260047 260010	 	D=54, - Halter LUC D=54, - Halter LUC Bremsattel-Zubehör LUC Fallenbalgsatz LUC
	1.3 1.6 1.6 D 1.6 TD 1.8			08.84 08.84 08.84 08.84 08.84	07.86 03.88 03.88 03.88 03.88		13.0460-7032.2	607032		20887 19,7 +/Zub VW

1) + cast iron / + ghisa / + fonte grise / + fundición de gris
 2) + aluminium / + alluminio / + aluminium / + aluminio
 3) without sensor ring / senza sensori / sans secours ABS / sin anillo sensor ABS



								
VOLKSWAGEN PASSAT Variant (85-88)								
	2.0 2.2	85	08.84 08.85	03.88 03.88	13.0460-7033.2	607033		20887 15,3 +/Zub VW
	1.8 Syncro 2.0 Syncro 2.2 2.2 Syncro	100	01.86 08.84 01.85 08.84	07.88 07.88 03.88 07.88	13.0460-2957.2	602957		20168 16,0 /S LUC
	1.3 1.6 1.6 D 1.6 TD 1.8		08.84 08.84 08.84 08.84 08.84	07.86 03.88 03.88 03.88 03.88	24.0112-0106.1 24.0312-0106.1	412106 512106		239 12,0 10,0 +S +B 239 12,0 10,0 +S +B PD
	2.0 2.2	85	08.84 08.85	03.88 03.88	24.0120-0123.1 24.0320-0123.1	420123 520123		239 20,0 18,0 V L +S +B 239 20,0 18,0 V L +S +B PD
	1.8 Syncro 2.0 Syncro 2.2 2.2 Syncro	100	01.86 08.84 01.85 08.84	07.88 07.88 03.88 07.88	24.0120-0128.1 24.0320-0128.1	420128 520128		256 20,0 18,0 V L +S +B 256 20,0 18,0 V L +S +B PD
	1.3 1.6 1.6 D 1.6 TD 1.8 1.8 Syncro 2.0 2.0 Syncro 2.2 2.2 Syncro		08.84 08.84 08.84 08.84 08.84 01.86 08.84 08.84 01.85 08.84	07.86 03.88 03.88 03.88 03.88 07.88 03.88 07.88 03.88 07.88	24.5170-0315.3	331309	2	L=315
	2.2	100	01.85	03.88	24.3364-1605.5 24.3364-1606.5 24.0101-3601.2 11.0101-5403.2	240011 240012 260044 260010	 	D=36, - Halter LUC D=36, - Halter LUC Bremsattel-Zubehör LUC Faltenbalgsatz LUC
	1.8 Syncro 2.0 Syncro 2.2 Syncro		01.86 08.84 08.84	07.88 07.88 07.88	24.3384-1603.5 24.3384-1604.5 24.0101-3601.2	240015 240016 260044	 	D=38, - Halter LUC D=38, - Halter LUC Bremsattel-Zubehör LUC
	1.8 Syncro 2.0 Syncro 2.2 2.2 Syncro	100	01.86 08.84 01.85 08.84	07.88 07.88 03.88 07.88	13.0460-2937.2 13.0460-0419.2	602937 610419		20961 15,2 /Zub/S LUC Belagsatz-Zubehör LUC
	2.2	100	01.85	03.88	24.0110-0111.1 24.0110-0275.2	410111 410275	ohne Sensorring ¹⁾ mit Sensorring ²⁾	226 10,0 8,0 +B 226 10,0 8,0
	1.8 Syncro 2.0 Syncro 2.2 Syncro		01.86 08.84 08.84	07.88 07.88 07.88	24.0110-0151.1	410151		239 10,0 8,0 +S +B
	1.3 1.6 1.6 D 1.6 TD 1.8 2.0 2.2	85	08.84 08.84 08.84 08.84 08.84 08.84 08.85	07.86 03.88 03.88 03.88 03.88 03.88 03.88	83.7824-0180.3 24.5201-0164.3	330812 331414	 	L=180 L=164
	2.2	100	01.85	03.88	24.5170-0161.3	331308	2	L=161
	1.8 Syncro 2.0 Syncro 2.2 Syncro		01.86 08.84 08.84	07.88 07.88 07.88	83.6204-0240.3 24.5170-0161.3	330718 331308	2 2	L=240 L=161
	1.3 1.6 1.6 D 1.6 TD 1.8 2.0 2.2	85	08.84 08.84 08.84 08.84 08.84 08.84 08.85	07.86 03.88 03.88 03.88 03.88 03.88 03.88	03.3217-2112.3 24.3217-0908.3	020027 020167	+ GG ⁴⁾ + ALU ⁵⁾	Rz 17,46 Rz 17,46
	1.3 1.6 1.6 D 1.6 TD 1.8 2.0 2.2	85	08.84 08.84 08.84 08.84 08.84 08.85	07.86 03.88 03.88 03.88 03.88 03.88	03.0137-0146.2 03.0137-9041.2	650146 669041		200 x 40 HEB Bremsbacken-Zubehör
	1.3 1.6 1.6 D 1.6 TD 1.8 2.0 2.2	85	08.84 08.84 08.84 08.84 08.84 08.85	07.86 03.88 03.88 03.88 03.88 03.88	24.0220-0018.1 24.0220-0718.2	480019 480209	ohne Sensorring ¹⁾ ohne Sensorring ¹⁾	200/201 x 50,5 - Lager 200/201,5 x 50,5 + Lager
	1.3 1.6 1.6 D 1.6 TD 1.8 2.0 2.2	85	08.84 08.84 08.84 08.84 08.84 08.85	07.86 03.88 03.88 03.88 03.88 03.88	03.0420-0417.3	680417		17,46/200x40 Kit VW

¹⁾ without sensor ring / senza sensori / sans secours ABS / sin anillo sensor ABS
²⁾ with sensor ring / con sensori / avec secours ABS / con anillo sensor ABS
³⁾ on the brake caliper / sulla pinza freno / sur l'étrier de frein / a la pinza de freno
⁴⁾ + cast iron / + ghisa / + fonte grise / + fundición de gris
⁵⁾ + aluminium / + alluminio / + aluminium / + aluminio

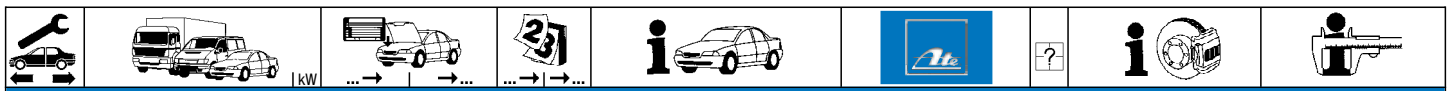







VOLKSWAGEN PASSAT Variant (85-88)

	1.3 1.6 1.6 D 1.6 TD 1.8 2.0 2.2	85		08.84 08.84 08.84 08.84 08.84 08.84 08.85	07.86 03.88 03.88 03.88 03.88 03.88 03.88	24.3727-0108.2	580108	1 ↓		L=2565
	1.8 Syncro 2.0 Syncro 2.2 Syncro		33-F-500000 33-F-500000 33-F-500000	01.86 08.84 08.84		03.6058-0301.3	320072			BR 25/5 (3) ATE
	1.8 Syncro 2.0 2.0 Syncro 2.2 2.2 Syncro	◀		01.86 08.84 08.84 08.85 08.84	07.88 03.88 07.88 03.88 07.88	03.2419-8150.3	030019			Gz 19,05
	1.8 Syncro 2.0 2.0 Syncro 2.2 2.2 Syncro	◀		01.86 08.84 08.84 08.85 08.84	07.88 03.88 07.88 03.88 07.88	03.2522-4211.3	040017			Nz 22,20
	1.3 1.6 1.8	◀		08.84 08.84 08.84	07.86 03.88 03.88	24.3728-0114.2	590114			L=944

VOLKSWAGEN PASSAT/SANTANA Limousine (73-84)

	1.3 1.5 1.6			05.73 05.73 09.75	07.79 08.75 07.79	+ Bremsgerät ¹⁾ + Bremsgerät/ + Schaltgetriebe ²⁾ + Bremsgerät/ + Schaltgetriebe ²⁾	03.2120-1531.3	010092		THz 20,64 ATE
	1.3 1.6			08.79 08.79	07.83 07.83	+ Bremsgerät ¹⁾ + Bremsgerät/ + Schaltgetriebe ²⁾	03.2120-1531.3 03.2120-1491.3	010092 010089		THz 20,64 ATE THz 20,64 + WE ATE
	1.6 1.6 D 1.8 i	◀		08.81 08.80 01.83	07.83 07.83 07.83	+ Automatikgetriebe ³⁾ + Schaltgetriebe ⁴⁾ + Schaltgetriebe ⁴⁾	03.2120-1531.3 03.2120-1491.3	010092 010089		THz 20,64 ATE THz 20,64 + WE ATE
	1.9	◀		08.81	07.83		03.2120-1531.3	010092		THz 20,64 ATE
	1.3 1.6	▶		08.83 08.83	07.84 07.84	+ Bremsgerät/ + Schaltgetriebe ²⁾ + Bremsgerät/ + Schaltgetriebe ²⁾	03.2120-2331.3	010110		THz 20,64 ATE
	1.6 1.6 D 1.6 TD 1.8 i 1.9 2.0	▶		08.81 08.80 12.81 01.83 01.81 08.83	07.83 07.84 07.84 07.84 07.83 07.84	+ Automatikgetriebe ³⁾ + Automatikgetriebe ³⁾	03.2120-2331.3	010110		THz 20,64 ATE
	1.3 1.5 1.6 1.6 i			05.73 05.73 09.75 08.76	07.77 08.75 07.77 07.80		03.3508-7504.3	310045	ohne Warneinrichtung ⁶⁾	Behälter ATE
	1.3 1.5 D 1.6 D			05.73 08.77 08.80	07.82 07.80 08.81		11.0441-4402.2	250014		Dichtungssatz ATE
	1.5 1.6 1.6 1.6 i			05.73 09.75 08.78 10.76	08.75 07.78 01.80 01.80	+ Schaltgetriebe ⁴⁾	11.0441-4402.2	250014		Dichtungssatz ATE
	1.3 1.6 1.6 D 1.6 i 1.6 TD 1.8 i 1.9 2.0 2.2			08.82 02.80 09.81 02.79 12.81 01.83 01.81 08.83 01.81	11.83 11.83 11.83 07.80 11.83 11.83 07.83 11.83 07.83	+ S ↓	11.0441-4808.2 11.0441-4804.2 11.0101-4801.2 24.0102-4801.2	250022 250019 260006 260085	f.Vornr.-8007/8008 -8503/8504 ⁵⁾	Dichtungssatz ATE Dichts.a.(+Sich.Ring) ATE Hülsensatz ATE Hülsensatz+Schrauben ATE
	1.3 1.6 1.6 D 1.6 TD 1.8 i 2.0			12.83 12.83 12.83 12.83 12.83 12.83	07.84 07.84 07.84 07.84 07.84 07.84		11.0441-4808.2 11.0101-4801.2 24.0102-4801.2	250022 260006 260085		Dichtungssatz ATE Hülsensatz ATE Hülsensatz+Schrauben ATE
	1.3 1.5 D			05.73 08.77	02.78 07.78	+ Schaltgetriebe ⁴⁾	13.0460-4028.2 13.0460-0029.2	604028 610029		20228 15,3 ATE Belagsatz-Zubehör ATE
	1.3 1.5 1.5 D 1.6 D			03.78 05.73 08.78 08.80	07.82 08.75 07.80 08.81	+ Schaltgetriebe ⁴⁾ + Schaltgetriebe ⁴⁾ + Schaltgetriebe ⁴⁾	13.0460-4028.2 13.0460-0115.2 13.0460-0905.2	604028 610115 610905		20228 15,3 ATE Belagsatz-Zubehör ATE Belagsatz-Zubehör LUC
	1.5 1.5 D 1.6 1.6 i			05.73 08.77 09.75 09.75	08.75 07.78 07.78 01.80	+ Automatikgetriebe ³⁾ + Automatikgetriebe ³⁾ + Automatikgetriebe ³⁾ + Automatikgetriebe ³⁾	13.0460-4029.2	604029		20228 18,5 ATE
	1.3 1.6 D 1.6 TD 1.8 i			08.82 09.81 12.81 01.83	07.84 07.84 07.84 07.84	+ Schaltgetriebe ⁴⁾ - GT	13.0460-7032.2	607032		20887 19,7 +/Zub VW
↓	1.5 D			02.80	07.80	+ Automatikgetriebe ³⁾	13.0460-7032.2	607032		20887 19,7 +/Zub VW

1) + booster unit / + servofreno / + servo-frein / + servofreno
2) + booster unit / + manual transm. / + servofreno / + scatola camb.velocità / + servo-frein / + transm.mécanique / + servofreno / + camb.de velocidad
3) + autom.transmission / + scatola cambio automatico / + transmission automatique / + cambio automático
4) + manual transmission / + scatola cambio velocità / + transmission mécanique / + cambio de velocidad
5) f.partno.-8007/8008 -8503/8504 / p.no.codice -8007/8008 -8503/8504 / p.AV ref. -8007/8008 -8503/8504 / p.antes ref. -8007/8008 -8503/8504
6) without alarm / senza dispositivo d'allarme / sans dispositif d'avertissement / sin dispositivo avisador

VOLKSWAGEN PASSAT/SANTANA Limousine (73-84)											
	1.6	02.80	07.84	+ Schaltgetriebe 1)	13.0460-7032.2	607032			20887 19,7 +/Zub	VW	
	1.6	02.80	07.84	+ Automatikgetriebe 2)							
	1.6 D	08.80	07.84	+ Automatikgetriebe 2)							
	1.6 i	02.80	07.80	+ Automatikgetriebe 2)							
	1.6 TD	12.81	07.84	+ Automatikgetriebe 2)							
	1.8 GT	12.83	07.84	+ Automatikgetriebe 2)							
	1.8 i	01.83	07.84	+ Automatikgetriebe 2)							
	1.9	01.81	07.83	+ Automatikgetriebe 2)							
	2.0	08.83	07.84	+ Automatikgetriebe 2)							
		1.6 i	09.75	07.80	+ S J	13.0460-7033.2	607033			20887 15,3 +/Zub	VW
	1.6 i	02.79	07.80								
	1.8 GT	12.83	07.84								
	1.9	01.81	07.83								
	2.0	08.83	07.84								
	2.2	01.81	07.83	+ S							
	1.3	05.73	07.82		24.0110-0151.1	410151			239 10,0 8,0 +S +B		
	1.5 D	08.77	07.80		24.0310-0151.1	510151			239 10,0 8,0 +S +B PD		
	1.6 D	08.80	08.81								
	1.3	08.82	07.84		24.0112-0106.1	412106			239 12,0 10,0 +S +B		
	1.5	05.73	08.75		24.0312-0106.1	512106			239 12,0 10,0 +S +B PD		
	1.6	09.75	07.84								
	1.6 D	09.81	07.84								
	1.6 TD	12.81	07.84								
	1.8 i	01.83	07.84	- GT							
		1.6 i	09.75	07.80	+ S J	24.0120-0123.1	420123			239 20,0 18,0 V L +S +B	
	1.6 i	02.79	07.80		24.0320-0123.1	520123			239 20,0 18,0 V L +S +B PD		
	1.8 GT	12.83	07.84								
	1.9	01.81	07.83								
	2.0	08.83	07.84								
	2.2	01.81	07.83	+ S							
	1.3	05.73	07.84		24.5170-0315.3	331309	2		L=315	LUC	
	1.5	05.73	08.75		24.5108-0266.3	330038	2		L=266		
	1.5 D	08.77	07.80								
	1.6	09.75	07.84								
	1.6 D	08.80	07.84								
	1.6 i	09.75	07.80								
	1.6 TD	12.81	07.84								
	1.8 GT	12.83	07.84								
	1.8 i	01.83	07.84								
	1.9	01.81	07.83								
	2.0	08.83	07.84								
	1.3	05.73	07.80		83.7824-0180.3	330812	2		L=180		
	1.5	05.73	08.75								
	1.5 D	08.77	07.80								
	1.6	09.75	07.80								
	1.6 i	09.75	07.80								
		1.3	08.80	07.84		24.5201-0164.3	331414	2		L=164	
		1.6	08.80	07.84	+ Schaltgetriebe 1)						
		1.6 D	08.80	07.84	+ Schaltgetriebe 1)						
		1.6	08.80	07.84	+ Automatikgetriebe 2)	83.7824-0180.3	330812			L=180	
		1.6 D	08.80	07.84	+ Automatikgetriebe 2)	24.5201-0164.3	331414			L=164	
	1.6 TD	12.81	07.84								
	1.9	01.81	07.83								
	2.0	08.83	07.84								
	2.2	01.81	07.83	+ S							
	1.3	05.73	07.84		03.3214-0812.3	020011		+ GG 3)	Rz 14,29		
	1.5	05.73	08.75	+ Schaltgetriebe 1)	24.3214-0902.3	020147		+ ALU 4)	Rz 14,29		
	1.5 D	08.77	07.80	+ Schaltgetriebe 1)							
	1.6	09.75	07.81	+ Schaltgetriebe 1)							
	1.6 D	08.80	07.81	+ Schaltgetriebe 1)							
		1.6	08.81	07.84	+ Schaltgetriebe 1)	03.3215-2311.3	020018		+ GG 3)	Rz 15,87	
		1.6 D	08.81	07.84	+ Schaltgetriebe 1)	24.3215-0903.3	020154		+ ALU 4)	Rz 15,87	
		1.8 i	01.83	07.84	- GT/ + Schaltgetriebe 5)						
		1.9	01.81	07.81							
		2.2	01.81	07.81	+ S						
	1.5	05.73	08.75	+ Automatikgetriebe 2)	03.3217-2112.3	020027		+ GG 3)	Rz 17,46		
	1.5 D	08.77	07.80	+ Automatikgetriebe 2)	24.3217-0908.3	020167		+ ALU 4)	Rz 17,46		
	1.6	09.75	07.84	+ Automatikgetriebe 2)							
	1.6 D	08.80	07.84	+ Automatikgetriebe 2)							
	1.6 i	09.75	07.80								
	1.6 TD	12.81	07.84								
	1.8 i	01.83	07.84	- GT/ + Automatikgetriebe 6)							
	1.9	08.81	07.83								
	2.0	08.83	07.84								
	2.2	08.81	07.83	+ S							
	1.3	05.73	07.78		03.0137-9006.2	669006			Bremsbacken-Zubehör		
	1.5	05.73	08.75	+ Schaltgetriebe 1)							
	1.5 D	08.77	07.78	+ Schaltgetriebe 1)							
	1.6	09.75	07.78	+ Schaltgetriebe 1)							
		1.3	08.78	07.84		03.0137-0126.2	650126			180 x 31 HEB	
		1.5 D	08.78	07.80	+ Schaltgetriebe 1)	03.0137-9008.2	669008			Bremsbacken-Zubehör	
		1.6	08.78	07.84	+ Schaltgetriebe 1)						
		1.6 D	08.80	07.84	+ Schaltgetriebe 1)						
		1.5 D	08.78	07.80	+ Automatikgetriebe 2)	03.0137-0146.2	650146			200 x 40 HEB	
		1.6	08.78	07.84	+ Automatikgetriebe 2)	03.0137-9041.2	669041			Bremsbacken-Zubehör	

1) + manual transmission / + scatola cambio velocità / + transmission mécanique / + cambio de velocidad
2) + autom.transmission / + scatola cambio automatico / + transmission automatique / + cambio automático
3) + cast iron / + ghisa / + fonte grise / + fundición de gris
4) + aluminium / + alluminio / + aluminium / + aluminio
5) - GT/ + manual transm. / - GT/+ scatola cambio velocità / - GT/ + transmission mécanique / - GT/ + cambio de velocidad
6) - GT/ + autom.transmission / - GT/+ scatola cambio autom. / - GT/ + transmission automatique / - GT/ + cambio automático



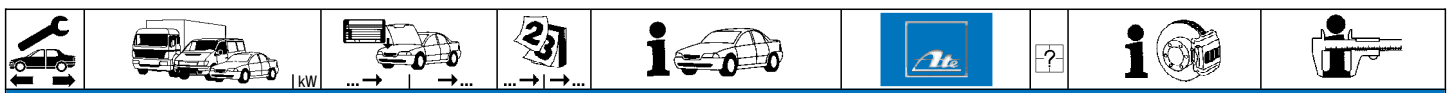

VOLKSWAGEN PASSAT/SANTANA Limousine (73-84)













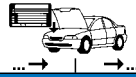



	1.6 D 1.6 i 1.6 TD 1.8 i 1.9 2.0 2.2		08.80 02.79 12.81 01.83 01.81 08.83 01.81	07.84 07.80 07.84 07.84 07.83 07.84 07.83	+ Automatikgetriebe ¹⁾	03.0137-0146.2 03.0137-9041.2	650146 669041		200 x 40 HEB Bremsbacken-Zubehör
	1.3 1.5 1.5 D 1.6 1.6 D		05.73 05.73 08.77 09.75 08.80	07.84 08.75 07.80 07.84 07.84	+ Schaltgetriebe ²⁾	24.0218-0007.1 24.0218-0707.2	480003 480211		180/181 x 38,5 - Lager 180/181 x 38,5 + Lager
	1.5 1.5 D 1.6 1.6 D 1.6 i 1.6 TD 1.8 i 1.9 2.0 2.2		05.73 08.77 09.75 08.80 02.79 12.81 01.83 01.81 08.83 01.81	08.75 07.80 07.84 07.84 07.80 07.84 07.84 07.83 07.84 07.83	+ Automatikgetriebe ¹⁾ + Automatikgetriebe ¹⁾ + Automatikgetriebe ¹⁾ + Automatikgetriebe ¹⁾	24.0220-0018.1 24.0220-0718.2	480019 480209	ohne Sensorring ³⁾ ohne Sensorring ³⁾	200/201 x 50,5 - Lager 200/201,5 x 50,5 + Lager
	1.3 1.5 D 1.6 1.6 D		08.78 08.78 08.78 08.80	07.84 07.80 07.81 07.81	+ Schaltgetriebe ²⁾ + Schaltgetriebe ²⁾ + Schaltgetriebe ²⁾	03.0520-0114.3	690114		14,29/180x31 TopKit VW
	1.6 1.6 D		08.81 08.81	07.84 07.84	+ Schaltgetriebe ²⁾ + Schaltgetriebe ²⁾	03.0520-0215.3	690215		15,87/180x31 TopKit VW
	1.5 D 1.6 1.6 D 1.6 i 1.6 TD 1.8 i 1.9 2.0 2.2		08.78 08.78 08.80 02.79 12.81 01.83 08.81 08.83 08.81	07.80 07.84 07.84 07.80 07.84 07.84 07.83 07.84 07.83	+ Automatikgetriebe ¹⁾ + Automatikgetriebe ¹⁾ + Automatikgetriebe ¹⁾ - GT/ + Automatikgetriebe ⁴⁾	03.0420-0417.3	680417		17,46/200x40 Kit VW
	1.3 1.6 1.6 D 1.8 GT 1.8 i 1.9 2.0		08.80 08.80 08.80 12.81 01.83 01.81 08.83	07.84 07.84 07.84 07.84 07.84 07.83 07.84		24.3727-0108.2	580108	1 ↓	L=2565
	1.3 1.5 1.5 D 1.6 1.6 i	32-42143626 32-42143626 32-42143626 32-42143626		07.80 08.75 07.80 07.80 07.80		03.6565-0101.3	320097		BRL 6/5 (4) ATE
	1.3 1.6 1.8	66	08.83 08.83 08.83	07.84 07.84 07.84		24.3728-0114.2	590114		L=944

VOLKSWAGEN PASSAT (88-93)

	1.6 1.6 TD 1.8 1.8 16V 1.9 D 1.9 TD 2.0 2.0 16V 2.8 VR6		04.88 08.88 04.88 04.88 05.89 03.91 03.90 04.88 06.91	10.93 10.93 10.93 07.92 10.93 10.93 10.93 10.93 10.93	- ABS - ABS - ABS - ABS - ABS - ABS - ABS - ABS - ABS	03.7750-4302.4	300076		9" ATE
	1.6 1.6 TD 1.8 1.8 16V 1.9 D 1.9 TD 2.0 2.0 16V 2.8 VR6		04.88 08.88 04.88 04.88 05.89 03.91 03.90 04.88 06.91	10.93 10.93 10.93 07.92 10.93 10.93 10.93 10.93 10.93	- ABS - ABS - ABS - ABS - ABS - ABS - ABS - ABS - ABS	03.7750-4902.4	300079		9" ATE
	1.6 1.6 TD 1.8 1.9 D 1.9 TD 2.0	55	04.88 08.88 08.90 05.89 03.91 03.90	07.91 07.91 07.91 07.91 07.91 07.91	- ABS - ABS - ABS - ABS - ABS - ABS	03.2120-3943.3 03.3517-0101.2	010532 390322		THz 20,64 Verschlusschraube ATE
	1.6 1.6 TD 1.8 1.8 1.8 1.8	55 66 79 82	08.91 08.91 04.88 04.88 04.88	10.93 10.93 10.93 10.93 07.90 07.90	- ABS - ABS - ABS - ABS - ABS - ABS	03.2122-1042.3 03.3517-0101.2	010137 390322		THz 22,20 Verschlusschraube ATE

¹⁾ + autom.transmission / + scatola cambio automatico / + transmission automatique / + cambio automático
²⁾ + manual transmission / + scatola cambio velocità / + transmission mécanique / + cambio de velocidad
³⁾ without sensor ring / senza sensori / sans secours ABS / sin anillo sensor ABS
⁴⁾ - GT/ + autom.transmission / - GT/+ scatola cambio autom. / - GT/ + transmission automatique / - GT/ + cambio automático



									
VOLKSWAGEN PASSAT (88-93)									
	1.8 16V 1.9 D 1.9 TD 2.0 2.0 16V		04.88 08.91 08.91 08.91 08.88	07.91 10.93 10.93 10.93 07.91	- ABS - ABS - ABS - ABS - ABS	03.2122-1042.3 03.3517-0101.2	010137 390322	THz 22,20 Verschlusschraube	ATE
	1.6 Limousine		04.88	09.89	- ABS	24.3541-1609.5 24.3541-1610.5 11.0441-4808.2 11.0101-4801.2 24.0102-4801.2 24.0101-4301.2 11.0101-5403.2	240039 240040 250022 260006 260085 260047 260010	D=54, - Halter D=54, - Halter Dichtungssatz Hülensatz Hülensatz+Schrauben Bremsattel-Zubehör Fallenbalgsatz	LUC LUC ATE ATE LUC LUC
	1.6 1.6 Limousine 1.6 TD 1.6 Variant 1.8 1.8 16V 1.9 D 1.9 TD 2.0 2.0 16V 2.0 Syncro		10.89 04.88 08.88 04.88 04.88 04.88 05.89 03.91 03.90 08.88 10.90	10.93 09.89 10.93 09.89 10.93 07.92 10.93 10.93 10.93 10.93 10.93	+ ABS	24.3541-1609.5 24.3541-1610.5 24.0101-4301.2 11.0101-5403.2	240039 240040 260047 260010	D=54, - Halter D=54, - Halter Bremsattel-Zubehör Fallenbalgsatz	LUC LUC LUC LUC
	1.8 Syncro G60 2.8 VR6		08.88 06.91	10.93 10.93		24.3541-1731.5 24.3541-1732.5	240061 240062	D=54, - Halter D=54, - Halter	LUC LUC
	1.6 Limousine		04.88	09.89	- ABS	13.0460-7032.2 13.0460-2958.2	607032 602958	20887 19,7 +/Zub 20168 19,3 /S	VW LUC
	1.6 Limousine 1.6 Limousine 1.6 TD 1.6 Variant 1.8 1.8 1.8 Syncro G60 1.9 D 1.9 TD 2.8 VR6	55 66	10.89 04.88 08.88 04.88 04.88 04.88 08.88 05.89 03.91 06.91	10.93 10.93 10.93 10.93 10.93 10.93 10.93 10.93 10.93 10.93	- ABS + ABS	13.0460-2958.2	602958	20168 19,3 /S	LUC
	1.8 1.8 1.8 16V 2.0 2.0 16V 2.0 Syncro	79 82	04.88 04.88 04.88 03.90 08.88 10.90	07.90 07.90 07.92 10.93 10.93 10.93		13.0460-2957.2	602957	20168 16,0 /S	LUC
	1.6 1.6 TD 1.8 1.8 1.9 D 1.9 TD	55 66	04.88 08.88 04.88 04.88 05.89 03.91	10.93 10.93 10.93 10.93 10.93 10.93	- ABS + ABS	24.0113-0178.1 24.0313-0178.1	413178 513178	256 12,9 11,0 +S +B 256 12,9 11,0 +S +B PD	
	1.8 1.8 1.8 16V 2.0 2.0 16V 2.0 Syncro	79 82	04.88 04.88 04.88 03.90 08.88 10.90	07.90 07.90 07.92 10.93 10.93 10.93		24.0120-0128.1 24.0320-0128.1	420128 520128	256 20,0 18,0 V L +S +B 256 20,0 18,0 V L +S +B PD	
	1.8 Syncro G60 2.8 VR6	31-N-255990	08.88	10.93 10.93		24.0122-0101.1 24.0122-0100.1 24.0322-0100.1	422101 422100 522100	280 22,0 20,0 V L +B 280 22,0 20,0 V L +B 280 22,0 20,0 V L +S +B PD	
	1.6 1.6 TD 1.8 1.8 16V 1.8 Syncro G60 1.9 D 1.9 TD 2.0 2.0 16V 2.0 Syncro 2.8 VR6		04.88 08.88 04.88 04.88 08.88 05.89 03.91 03.90 08.88 10.90 06.91	10.93 10.93 10.93 07.92 10.93 10.93 10.93 10.93 10.93 10.93 10.93		24.5237-0333.3	331425	L=333	2
	1.6 1.6 TD 1.8 1.8 16V 1.8 Syncro G60 1.9 D 1.9 TD 2.0 2.0 16V 2.0 Syncro 2.8 VR6		04.88 08.88 04.88 04.88 09.89 05.89 03.91 03.90 04.88 10.90 06.91	10.93 10.93 10.93 07.92 10.93 10.93 10.93 10.93 10.93 10.93 10.93		24.0711-1313.3	360016	Radsensor L=1130	2
	1.8 1.8 1.8 16V 1.8 Syncro G60 2.0 2.0	79 82	04.88 04.88 04.88 08.88 03.90 03.90	07.90 07.90 07.92 08.88 03.90 03.90		24.3384-1603.5 24.3384-1604.5 24.0101-3601.2	240015 240016 260044	D=38, - Halter D=38, - Halter Bremsattel-Zubehör	LUC LUC LUC
			31-P-080000 31-PE080000 31-PB080000	08.88 03.90 03.90					

VOLKSWAGEN PASSAT (88-93)												
	2.0 16V		31-PE080000	08.88		24.3384-1603.5	240015				D=38, - Halter	LUC
	2.0 16V		31-PB080000	08.88		24.3384-1604.5	240016				D=38, - Halter	LUC
	2.0 Syncro		31-P-080000	10.90		24.0101-3601.2	260044				Bremssattel-Zubehör	LUC
	2.8 VR6		31-PE080000	06.91								LUC
	2.8 VR6		31-PB080000	06.91								LUC
	1.8 Syncro G60		31-P-080001		10.93	24.3384-1707.5	240171				D=38, - Halter	LUC
	2.0		31-PE080001		10.93	24.3384-1708.5	240172				D=38, - Halter	LUC
	2.0		31-PB080001		10.93	24.0101-3601.2	260044				Bremssattel-Zubehör	LUC
	2.0 16V		31-PE080001		10.93	11.0101-5403.2	260010				Faltenbalgsatz	LUC
	2.0 16V		31-PB080001		10.93							LUC
	2.0 Syncro		31-P-080001		10.93							LUC
	2.8 VR6		31-PE080001		10.93							LUC
	2.8 VR6		31-PB080001		10.93							LUC
	1.8	79		04.88	07.90	13.0460-2937.2	602937				20961 15,2 /Zub/S	LUC
	1.8	82		04.88	07.90	13.0460-0419.2	610419				Belagsatz-Zubehör	LUC
	1.8 16V			04.88	07.92							LUC
	1.8 Syncro G60		31-P-080000	08.88								LUC
	2.0		31-PE080000	03.90								LUC
	2.0		31-PB080000	03.90								LUC
	2.0 16V		31-PE080000	08.88								LUC
	2.0 16V		31-PB080000	08.88								LUC
	2.0 Syncro		31-P-080000	10.90								LUC
	2.8 VR6		31-PE080000	06.91								LUC
	2.8 VR6		31-PB080000	06.91								LUC
	1.8 Syncro G60		31-P-080001		10.93	13.0460-2984.2	602984				20961 17,2 /Zub/S	LUC
	2.0		31-PE080001		10.93	13.0460-0072.2	610072				Belagsatz-Zubehör	LUC
	2.0		31-PB080001		10.93							LUC
	2.0 16V		31-PE080001		10.93							LUC
	2.0 16V		31-PB080001		10.93							LUC
	2.0 Syncro		31-P-080001		10.93							LUC
	2.8 VR6		31-PE080001		10.93							LUC
	2.8 VR6		31-PB080001		10.93							LUC
	1.8	79		04.88	07.90	24.0110-0111.1	410111			ohne Sensorring ¹⁾	226 10,0 8,0 +B	
	1.8	82		04.88	07.90	24.0110-0275.2	410275			mit Sensorring ²⁾	226 10,0 8,0	
	1.8 16V			04.88	07.92							
	2.0			03.90	10.93							
	2.0 16V			08.88	10.93							
	1.8 Syncro G60			08.88	10.93	24.0110-0151.1	410151				239 10,0 8,0 +S +B	
	2.0 Syncro			10.90	10.93							
	2.8 VR6			06.91	10.93	24.0110-0203.1	410203				226 10,0 8,0 +B	
	2.8 VR6			06.91	10.93	24.0110-0276.2	410276			mit Sensorring ²⁾	226 10,0 8,0	
	1.6			04.88	10.93	83.7824-0180.3	330812	2			L=180	
	1.6 TD			08.88	10.93							
	1.8	55		04.88	10.93							
	1.8	66		04.88	10.93							
	1.9 D			05.89	10.93							
	1.9 TD			03.91	10.93							
	1.8	79		04.88	07.90	83.7824-0180.3	330812	2			L=180	
	1.8	82		04.88	07.90	24.5170-0161.3	331308	2		am Bremssattel ³⁾	L=161	
	2.0			03.90	10.93							
	2.0 16V			08.88	10.93							
	2.8 VR6			06.91	10.93							
	1.8 Syncro G60			08.88	10.93	24.5201-0164.3	331414	2			L=164	
	2.0 Syncro			10.90	10.93	24.5170-0161.3	331308	2		am Bremssattel ³⁾	L=161	
	1.6			04.88	10.93	24.0721-1925.1	360039	2			Radsensor L=1220	
	1.6 TD			08.88	10.93							
	1.8			04.88	10.93							
	1.8 16V			04.88	10.93							
	1.9 D			05.89	10.93							
	1.9 TD			03.91	10.93							
	2.0			03.90	10.93							
	2.0 16V			04.88	10.93							
	2.8 VR6			06.91	10.93							
	1.6 Limousine			04.88		24.3219-0909.3	020188				Rz 19,05	
	1.6 Limousine		31-L-085000		10.93	24.3220-0909.3	020210				Rz 20,64	
	1.6 TD			08.88	10.93							
	1.6 Variant			04.88	10.93							
	1.8	55		04.88	10.93							
	1.8	66		04.88	10.93							
	1.9 D			05.89	10.93							
	1.9 TD			03.91	10.93							
	1.6 Limousine		31-L-085000	04.88		03.0137-0268.2	650268				200 x 40 HEB	VW
	1.6 Limousine					03.0137-9168.2	669168				Bremsbacken-Zubehör	VW
	1.6 TD		31-L-085001	31-M-280000		03.0137-0264.2	650264				230 x 40 HEB	VW
	1.6 Variant			08.88		03.0137-9164.2	669164				Bremsbacken-Zubehör	VW
	1.8	55		31-M-280000	04.88							
	1.8	66		31-M-280000	04.88							
	1.9 D			31-M-280000	04.88							
	1.9 D			05.89								
	1.6 Limousine		31-M-280001		10.93	03.0137-0264.2	650264				230 x 40 HEB	VW
	1.6 TD		31-M-280001		10.93	03.0137-9149.2	669149				Bremsbacken-Zubehör	VW
	1.6 Variant		31-M-280001		10.93							
	1.8	55	31-M-280001		10.93							
	1.8	66	31-M-280001		10.93							
	1.9 D		31-M-280001		10.93							
	1.9 D				10.93							

¹⁾ without sensor ring / senza sensori / sans secours ABS / sin anillo sensor ABS

²⁾ with sensor ring / con sensori / avec secours ABS / con anillo sensor ABS

³⁾ on the brake caliper / sulla pinza freno / sur l'étrier de frein / a la pinza de freno

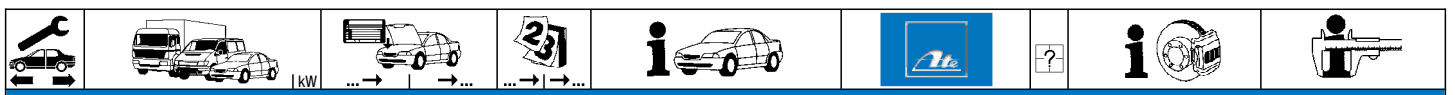

VOLKSWAGEN PASSAT (88-93)

	1.9 TD			03.91	10.93		03.0137-0264.2	650264		230 x 40 HEB	VW
							03.0137-9149.2	669149		Bremsbacken-Zubehör	
	1.6 Limousine		31-L-085000	04.88			24.0220-0018.1	480019	ohne Sensorring ¹⁾	200/201 x 50,5 - Lager	
							24.0220-0718.2	480209	ohne Sensorring ¹⁾	200/201,5 x 50,5 + Lager	
	1.6 Limousine	31-L-085001			10.93		24.0223-0012.1	480042	ohne Sensorring ¹⁾	230/231,5 x 51,5	
	1.6 TD			08.88	10.93						
	1.8	55		04.88	10.93						
	1.8	66		04.88	10.93						
	1.9 D			05.89	10.93						
	1.9 TD			03.91	10.93						
	1.6 Limousine		31-L-085000	04.88			03.0420-4219.3	684219		19,05/200x40 Kit	VW
							03.0520-4219.3	694219		19,05/200x40 TopKit	VW
	1.6 Limousine	31-L-085001	31-M-280000				03.0520-6120.3	696120		20,64/230x40 TopKit	VW
	1.6 TD		31-M-280000	08.88							
	1.6 Variant		31-M-280000	04.88							
	1.8	55	31-M-280000	04.88							
	1.8	66	31-M-280000	04.88							
	1.9 D		31-M-280000	05.89							
	1.6 Limousine	31-M-280001			10.93		03.0520-6120.3	696120		20,64/230x40 TopKit	VW
	1.6 TD	31-M-280001			10.93						
	1.6 Variant	31-M-280001			10.93						
	1.8	55	31-M-280001		10.93						
	1.8	66	31-M-280001		10.93						
	1.9 D		31-M-280001		10.93						
	1.9 TD			03.91	10.93						
	1.6			04.88	10.93		24.3727-0125.2	580125	2 ↓	L=1628	
	1.6 TD			08.88	10.93						
	1.8	55		04.88	10.93						
	1.8	66		04.88	10.93						
	1.9 D			05.89	10.93						
	1.9 TD			03.91	10.93						
	1.8	79		04.88	07.90		24.3727-0126.2	580126	2 ↓	L=1749	
	1.8	82		04.88	07.90						
	1.8 16V			04.88	07.92						
	2.0			03.90	10.93						
	2.0 16V			08.88	10.93						
	2.8 VR6			06.91	10.93						
	1.8 Syncro G60			08.88	10.93		24.3727-0167.2	580167	2 ↓	L=1718	
	2.0 Syncro			10.90	10.93						
	1.6			04.88	10.93		03.6584-0015.3	320109		BRL 8/4 (4)	ATE
	1.6 TD			08.88	10.93						
	1.8			04.88	10.93						
	1.8 16V			04.88	07.92						
	1.8 Syncro G60			08.88	10.93						
	1.9 D			05.89	10.93						
	1.9 TD			03.91	10.93						
	2.0			03.90	10.93						
	2.0 16V			08.88	10.93						
	2.0 Syncro			10.90	10.93						
	2.8 VR6			06.91	10.93						
	1.6 TD	79		08.88	10.93		03.2419-9310.3	030027		Gz 19,05	
	1.8			04.88	07.90						
	1.8	82		04.88	07.90						
	1.8 16V			04.88	07.92						
	1.8 Syncro G60			08.88	10.93						
	1.9 D			05.89	10.93						
	1.9 TD			03.91	10.93						
	2.0			03.90	10.93						
	2.0 16V			08.88	10.93						
	2.0 Syncro			10.90	10.93						
	2.8 VR6			06.91	10.93						
	1.6 TD	79		08.88	10.93		24.2523-0908.3	040049		Nz 23,81	
	1.8	82		04.88	07.90						
	1.8			04.88	07.90						
	1.8 16V			04.88	07.92						
	1.8 Syncro G60			08.88	10.93						
	1.9 D			05.89	10.93						
	1.9 TD			03.91	10.93						
	2.0			03.90	10.93						
	2.0 16V			08.88	10.93						
	2.0 Syncro			10.90	10.93						
	2.8 VR6			06.91	10.93						
	1.6			04.88	10.93		24.3728-0124.2	590124		L=1295, + AUT	
	1.6 TD			08.88	10.93						
	1.8	55		04.88	10.93						
	1.8	66		04.88	10.93						
	1.9 D			05.89	10.93						
	1.9 TD			03.91	10.93						































VOLKSWAGEN PASSAT (94-96)

	1.6			10.94	12.96	- ABS	03.7750-4302.4	300076		9"	ATE
	1.8			10.93	12.96	- ABS					
	1.9 TD	55		10.93	12.96	- ABS					
	1.9 TDI			10.93	12.96	- ABS					

¹⁾ without sensor ring / senza sensori / sans secours ABS / sin anillo sensor ABS





























VOLKSWAGEN PASSAT (94-96)												
	2.0			10.93	12.96	- ABS	03.7750-4302.4	300076			9"	ATE
	2.0 16V			01.94	12.96	- ABS						
	2.8 VR6			10.93	12.96	- ABS						
	1.6			10.94	12.95	- ABS	03.7750-4902.4	300079			9"	ATE
	1.8			10.93	12.95	- ABS						
	1.9 TD	55		10.93	12.95	- ABS						
	1.9 TDI			10.93	12.95	- ABS						
2.0			10.93	12.95	- ABS							
2.0 16V			01.94	12.95	- ABS							
2.8 VR6			10.93	12.95	- ABS							
	1.6			10.94	12.96	- ABS	03.2122-1042.3	010137			THz 22,20	ATE
	1.8			10.93	12.96	- ABS	03.3517-0101.2	390322			Verschlußschraube	
	1.9 TD	55		10.93	12.96	- ABS						
	1.9 TDI			10.93	12.96	- ABS						
	2.0			10.93	12.96	- ABS						
	2.0 16V			01.94	12.96	- ABS						
	2.8 VR6			10.93	12.95	- ABS						
	1.6			10.94	12.96	- ABS	10.6123-0674.3	010639			THz 23,81	ATE
	1.8			10.93	12.96	- ABS						
	1.9 TD	55		10.93	12.96	- ABS						
	1.9 TDI			10.93	12.96	- ABS						
	2.0			10.93	12.96	- ABS						
	2.0 16V			01.94	12.96	- ABS						
	2.0 Syncro			10.94	12.96	- ABS						
2.8 VR6			10.93	12.96	- ABS							
2.9 VR6 Syncro			10.94	12.96	- ABS							
1.6		3A-T-000001		12.96	+ ABS	03.2123-1424.3	010637			THz 23,81	ATE	
1.8		3A-T-000001		12.96	+ ABS							
1.9 TD	55	3A-T-000001		12.96	+ ABS							
1.9 TDI		3A-T-000001		12.96	+ ABS							
2.0		3A-T-000001		12.96	+ ABS							
2.0 16V		3A-T-000001		12.96	+ ABS							
2.0 Syncro		3A-T-000001		12.96	+ ABS							
2.8 VR6		3A-T-000001		12.96	+ ABS							
2.9 VR6 Syncro		3A-T-000001		12.96	+ ABS							
1.6		3A-T-000001		12.96	+ ABS	03.2123-1484.3	010595			THz 23,81	ATE	
1.8		3A-T-000001		12.96	+ ABS							
1.9 TD	55	3A-T-000001		12.96	+ ABS							
1.9 TDI		3A-T-000001		12.96	+ ABS							
2.0		3A-T-000001		12.96	+ ABS							
2.0 16V		3A-T-000001		12.96	+ ABS							
2.8 VR6		3A-T-000001		12.96	+ ABS							
2.9 VR6 Syncro		3A-T-000001		12.96	+ ABS							
	1.6			10.94	12.96		24.3541-1609.5	240039	<input type="checkbox"/>		D=54, - Halter	LUC
	1.8			10.93	12.96		24.3541-1610.5	240040	<input type="checkbox"/>		D=54, - Halter	LUC
	1.9 TD	55		10.93	12.96		24.0101-4301.2	260047			Bremssattel-Zubehör	LUC
	1.9 TDI	66		10.93	12.96		11.0101-5403.2	260010			Faltenbalgsatz	LUC
	2.0			10.93	12.96							
	2.0 Syncro			01.94	12.96							
	1.9 TDI	81		03.96	12.96		24.3541-1731.5	240061	<input type="checkbox"/>		D=54, - Halter	LUC
							24.3541-1732.5	240062	<input type="checkbox"/>		D=54, - Halter	LUC
	2.0 16V			01.94	12.96		11.3541-8523.2	220115	<input type="checkbox"/>		D=54, - Halter	ATE
	2.8 VR6			10.93	12.96		11.3541-8524.2	220116	<input type="checkbox"/>		D=54, - Halter	ATE
	2.9 VR6 Syncro			10.94	12.96		24.3541-8523.5	240551	<input type="checkbox"/>		D=54, - Halter	ATE
							24.3541-8524.5	240552	<input type="checkbox"/>		D=54, - Halter	ATE
							11.8170-0306.1	260102	<input type="checkbox"/>	2	Halter	ATE
							11.0441-5409.2	250031	<input type="checkbox"/>		Dichtungssatz	ATE
							11.0101-5409.2	260035	<input type="checkbox"/>		Hülzensatz	ATE
							11.8171-0008.1	990049	<input type="checkbox"/>		Führungsbolzen	ATE
							11.8116-0143.1	390513	<input type="checkbox"/>	2	Haltefeder	ATE
	1.6			10.94	12.96		13.0460-2958.2	602958			20168 19,3 / S	LUC
	1.8			10.93	12.96							
	1.9 TD	55		10.93	12.96							
	1.9 TDI	66		10.93	12.96							
	1.9 TDI	81		03.96	12.96							
	1.6		3A-T-130757		12.96		13.0460-2957.2	602957			20168 16,0 / S	LUC
	1.9 TDI	66	3A-T-000001		12.96							
2.0			10.93	12.96								
2.0 Syncro			01.94	12.96								
2.0 16V			01.94	12.96		13.0460-7081.2	607081			21911 20,3 +	ATE	
2.8 VR6			10.93	12.96		13.0470-7081.2	LD7081			21911 20,3 +	ATE	
2.9 VR6 Syncro			10.94	12.96								
	1.6			10.94	12.96		24.0113-0178.1	413178			256 12,9 11,0 +S +B	
	1.8			10.93	12.96		24.0313-0178.1	513178			256 12,9 11,0 +S +B PD	
	1.9 TD	55		10.93	12.96							
	1.9 TDI	66		10.93	12.96							
	1.6		3A-T-130757		12.96		24.0120-0128.1	420128			256 20,0 18,0 V L +S +B	
	1.9 TDI	66	3A-T-000001		12.96		24.0320-0128.1	520128			256 20,0 18,0 V L +S +B PD	
	2.0			10.93	12.96							
	2.0 Syncro			01.94	12.96							
	1.9 TDI	81		03.96	12.96		24.0122-0100.1	422100			280 22,0 20,0 V L +B	
							24.0322-0100.1	522100			280 22,0 20,0 V L +B PD	
2.0 16V			01.94	12.96		24.0125-0108.1	425108			288 25,0 23,0 V L +B		
2.8 VR6			10.93	12.96								
2.9 VR6 Syncro			10.94	12.96								

												
VOLKSWAGEN PASSAT (94-96)												
	1.6			10.94	12.96	24.5237-0333.3	331425	2		L=333		
	1.8			10.93	12.96							
	1.9 TD	55		10.93	12.96							
	1.9 TDI			10.93	12.96							
	2.0			10.93	12.96							
	2.0 Syncro			01.94	12.96							
	2.0 16V			01.94	12.96	24.5147-0385.3	331427	2		L=384		
	2.8 VR6			10.93	12.96							
	2.9 VR6 Syncro			10.94	12.96							
		1.6			10.94	12.96	24.0711-1361.3	360022	☐ ☐		Radsensor Radsensor	
		1.8	55		10.93	12.96	24.0711-1362.3	360023				
		1.9 TD			10.93	12.96						
1.9 TDI				10.93	12.96							
2.0				10.93	12.96							
2.0 16V				01.94	12.96							
	2.0 Syncro			01.94	12.96							
	2.8 VR6			10.93	12.96							
	2.9 VR6 Syncro			10.94	12.96							
		1.9 TDI	66	3A-T-000001		12.96	24.3384-1707.5	240171	☐ ☐	D=38, - Halter D=38, - Halter Faltenbalgsatz Faltenbalgsatz	LUC LUC LUC	
		1.9 TDI	81		03.96	12.96	24.3384-1708.5	240172				
		2.0			10.93	12.96	11.0101-5403.2	260010				
2.0 16V				01.94	12.96							
2.0 Syncro				01.94	12.96							
2.8 VR6				10.93	12.96							
	2.9 VR6 Syncro			10.94	12.96							
		1.9 TDI	66	3A-T-000001		12.96	13.0460-2984.2	602984		20961 17,2 /Zub/S Belagsatz-Zubehör	LUC LUC	
		1.9 TDI	81		03.96	12.96	13.0460-0072.2	610072				
		2.0			10.93	12.96						
		2.0 16V			01.94	12.96						
		2.0 Syncro			01.94	12.96						
2.8 VR6				10.93	12.96							
	2.9 VR6 Syncro			10.94	12.96							
		1.9 TDI	66	3A-T-000001		12.96	24.0110-0111.1	410111	ohne Sensorring ¹⁾ mit Sensorring ²⁾	226 10,0 8,0 +B 226 10,0 8,0 226 10,0 8,0 +B 226 10,0 8,0 239 10,0 8,0 +S +B		
		2.0			10.93	12.96	24.0110-0275.2	410275				
		1.9 TDI	81		03.96	12.96	24.0110-0203.1	410203	mit Sensorring ²⁾			
		2.0 16V			01.94	12.96	24.0110-0276.2	410276				
		2.8 VR6			10.93	12.96						
2.0 Syncro				01.94	12.96	24.0110-0151.1	410151					
	1.6			10.94	12.96	24.5201-0164.3	331414	2		L=164		
	1.8			10.93	12.96							
	1.9 TD	55		10.93	12.96							
	1.9 TDI	66	3A-S-300000	10.93	12.96							
		1.9 TDI	66	3A-T-000001		12.96	24.5201-0164.3	331414	2	L=164 L=161		
		1.9 TDI	81		03.96	12.96	24.5170-0161.3	331308			2	am Bremsattel ³⁾
2.0				10.93	12.96							
2.0 16V				01.94	12.96							
2.0 Syncro				01.94	12.96							
2.8 VR6				10.93	12.96							
	2.9 VR6 Syncro			10.94	12.96							
		1.6		3A-S-300000	10.94	12.96	24.0721-1925.1	360039	2 ☐	Radsensor L=1220		
		1.8	55	3A-S-300000	10.93	12.96						
		1.9 TD		3A-S-300000	10.93	12.96						
		1.9 TDI		3A-S-300000	10.93	12.96						
		2.0		3A-S-300000	10.93	12.96						
2.0 16V			3A-S-300000	01.94	12.96							
	2.8 VR6		3A-S-300000	10.93	12.96							
		1.6		3A-T-000001		12.96	24.0721-1193.3	360092	2 ☐	Radsensor L=870		
		1.8		3A-T-000001		12.96						
		1.9 TD	55	3A-T-000001		12.96						
		1.9 TDI		3A-T-000001		12.96						
		2.0		3A-T-000001		12.96						
2.0 16V			3A-T-000001		12.96							
	2.8 VR6		3A-T-000001		12.96							
		1.6			10.94	12.96	24.3220-0909.3	020210		Rz 20,64		
		1.8			10.93	12.96						
		1.9 TD	55		10.93	12.96						
		1.9 TDI	66	3A-S-300000	06.95	12.96						
			1.6			10.94	12.96	03.0137-0264.2	650264			230 x 40 HEB Bremsbacken-Zubehör
1.8					10.93	12.96	03.0137-9149.2	669149				
1.9 TD	55			10.93	12.96							
1.9 TDI	66		3A-S-300000	10.93	12.96							
	1.6				10.94	12.96	24.0223-0012.1	480042	ohne Sensorring ¹⁾	230/231,5 x 51,5		
	1.8				10.93	12.96						
	1.9 TD	55		10.93	12.96							
	1.9 TDI	66	3A-S-300000	10.93	12.96							
		1.6			10.94	12.96	03.0520-6120.3	696120			20,64/230x40 TopKit	VW
		1.8			10.93	12.96						
1.9 TD		55		10.93	12.96							
1.9 TDI		66	3A-S-300000	10.93	12.96							
		1.6			10.94	12.96	24.3727-0153.2	580153	2 ↕	L=1624		
		1.8			10.93	12.96						
	1.9 TD	55		10.93	12.96							
	1.9 TDI	66	3A-S-300000	10.93	12.96							
		1.9 TDI	66	3A-T-000001		12.96	24.3727-0152.2	580152	2 ↕		L=1721	
		1.9 TDI	81		03.96	12.96						

¹⁾ without sensor ring / senza sensori / sans secours ABS / sin anillo sensor ABS

²⁾ with sensor ring / con sensori / avec secours ABS / con anillo sensor ABS

³⁾ on the brake caliper / sulla pinza freno / sur l'étrier de frein / a la pinza de freno

								
VOLKSWAGEN PASSAT (94-96)								
	2.0 2.0 16V 2.8 VR6		10.93 01.94 10.93	12.96 12.96 12.96	24.3727-0152.2	580152	2 ↓	L=1721
	2.0 Syncro 2.9 VR6 Syncro		01.94 10.94	12.96 12.96	24.3727-0167.2	580167	2 ↓	L=1718
	1.6 1.8 1.9 TD 1.9 TDI 2.0 2.0 16V 2.0 Syncro 2.8 VR6 2.9 VR6 Syncro	55	10.94 10.93 10.93 10.93 10.93 01.94 01.94 10.93 10.94	12.96 12.96 12.96 12.96 12.96 12.96 12.96 12.96 12.96	03.6584-0015.3	320109		BRL 8/4 (4) ATE
	1.6 1.8 1.9 TD 1.9 TDI 2.0 2.0 16V 2.0 Syncro 2.8 VR6 2.9 VR6 Syncro	55	10.94 10.93 10.93 10.93 10.93 01.94 01.94 10.93 10.94	12.96 12.96 12.96 12.96 12.96 12.96 12.96 12.96 12.96	03.2419-1206.3	030074		Gz 19,05
	1.6 1.8 1.9 TD 1.9 TDI 2.0 2.0 16V 2.0 Syncro 2.8 VR6 2.9 VR6 Syncro	55	10.94 10.93 10.93 10.93 10.93 01.94 01.94 10.93 10.94	12.96 12.96 12.96 12.96 12.96 12.96 12.96 12.96 12.96	24.2523-0908.3	040049		Nz 23,81
VOLKSWAGEN POLO I (75-81)								
	0.9 1.1 1.3		04.75 04.75 12.76	09.81 09.81 09.81	03.2117-3311.3	010040		THz 17,46 ATE
					03.2120-1531.3	010092		THz 20,64 ATE
	1.1 1.3		04.75 12.76	09.81 09.81	03.3508-7504.3	310045	ohne Warneinrichtung ⁹⁾	Behälter ATE
	0.9 1.1 1.3		04.75 04.75 12.76	09.81 09.81 09.81	11.0441-4402.2	250014		Dichtungssatz ATE
	0.9 1.1 1.3		04.75 04.75 12.76	09.81 09.81 09.81	13.0460-4028.2	604028		20228 15,3 ATE
	0.9 1.1 1.3		04.75 04.75 12.76	09.81 09.81 09.81	24.0108-0100.1	408100		239 8,0 7,0
	0.9 1.1 1.3		04.75 04.75 12.76	09.81 09.81 09.81	83.7734-0290.3	330809	2	L=290
	0.9 1.1 1.3		04.75 04.75 12.76	09.81 09.81 09.81	83.7824-0180.3	330812	2	L=180
	0.9 1.1 1.3		04.75 04.75 12.76	09.81 09.81 09.81	03.3214-0812.3	020011	+ GG ³⁾	Rz 14,29
					24.3214-0902.3	020147	+ ALU ⁴⁾	Rz 14,29
	0.9 1.1 1.3		04.75 04.75 12.76	09.81 09.81 09.81	03.3217-2112.3	020027	+ GG ³⁾	Rz 17,46
					24.3217-0908.3	020167	+ ALU ⁴⁾	Rz 17,46
	0.9 1.1 1.3		04.75 04.75 12.76	07.78 07.78 07.78	03.0137-9006.2	669006	- autom. Nachstellung ⁶⁾	Bremsbacken-Zubehör
	0.9 1.1 1.3		08.78 08.78 08.78	09.81 09.81 09.81	03.0137-0126.2	650126		180 x 31 HEB
					03.0137-9008.2	669008		Bremsbacken-Zubehör
	0.9 1.1 1.3		04.75 04.75 12.76	09.81 09.81 09.81	24.0218-0007.1	480003		180/181 x 38,5 - Lager
					24.0218-0707.2	480211		180/181 x 38,5 + Lager
	0.9 1.1 1.3		08.78 08.78 08.78	09.81 09.81 09.81	03.0420-0617.3	680617	+ Rz GG ⁷⁾	17,46/180x31 Kit VW
					03.0520-3917.3	693917	+ Rz ALU ⁸⁾	17,46/180x31 TopKit VW
	0.9 1.1 1.3		04.75 04.75 12.76	09.81 09.81 09.81	24.3727-0146.2	580146	1 ↑	L=794
					24.3727-0103.2	580103	1 ↓	L=1960
	0.9 1.1 1.3		04.75 04.75 12.76	09.81 09.81 09.81	24.3728-0101.2	590101		L=607

1) + booster unit / + servofreno / + servo-frein / + servofreno

2) - brake pressure regulator / - correttore di frenata / - correcteur de freinage / - corrector de frenado

3) + cast iron / + ghisa / + fonte grise / + fundición de gris

4) + aluminium / + alluminio / + aluminium / + aluminio





















5) + brake pressure regulator / + correttore di frenata / + correcteur de freinage / + corrector de frenado

6) - automatic adjustment / - correzione automatica / - ajustage automatique / - reajuste automatico

7) + WC cast iron / + CR ghisa / + CR fontegrise / + CR fundición de gris

8) + WC aluminium / + CR alluminio / + CR aluminium / + CR aluminio

9) without alarm / senza dispositivo d'allarme / sans dispositif d'avertissement / sin dispositivo avisador

											
VOLKSWAGEN POLO II (81-94)											
	1.0 1.0			10.81 09.94	09.94 09.94	- Bremsgerät ¹⁾ - Bremsgerät ¹⁾	03.2117-3311.3 03.3517-0101.2	010040 390322	THz 17,46 Verschlusschraube	ATE	
	1.0 1.1 1.3		..-F-127903 ..-F-127903	10.81 10.81 10.81	07.83	+ Bremsgerät ²⁾	03.2120-1531.3	010092	THz 20,64	ATE	
	1.0 1.3 1.3 D 1.3 G40 1.4 D	..-F-127904 ..-F-127904		09.94 09.94 08.86 01.87 08.90	09.94 09.94 09.94 09.94	+ Bremsgerät ²⁾	03.2120-2031.3	010106	THz 20,64	ATE	
	1.1 1.3			10.81 10.81	07.83 02.85		03.3508-7504.3	310045	ohne Warneinrichtung ⁹⁾	Behälter	ATE
	1.0 1.1 1.3			10.81 10.81 10.81	02.85 07.83 02.85		11.0441-4402.2	250014		Dichtungssatz	ATE
	1.0 1.3 1.3 D 1.4 D			03.85 03.85 08.86 08.90	09.94 09.94 09.94 09.94		24.3481-1745.5 24.3481-1746.5 11.0441-4808.2 11.0101-4803.2 24.0102-4803.2	240277 240278 250022 260008 260086	D=48, - Halter D=48, - Halter Dichtungssatz Hülensatz Hülensatz+Schrauben	ATE ATE ATE ATE	
	1.3 G40			01.87	09.94		11.0441-4808.2	250022	Dichtungssatz	ATE	
							11.0101-4801.2	260006	Hülensatz	ATE	
							24.0102-4801.2	260085	Hülensatz+Schrauben	ATE	
	1.0 1.1 1.3			10.81 10.81 10.81	02.85 07.83 02.85		13.0460-4028.2 13.0460-0115.2	604028 610115	20228 15,3 Belagsatz-Zubehör	ATE ATE	
	1.0 1.3 1.3 D 1.4 D			03.85 03.85 08.86 08.90	09.94 09.94 09.94 09.94		13.0460-7059.2 13.0460-0184.2	607059 610184	20887 17,3 +/Zub Belagsatz-Zubehör	VW VW	
	1.3 G40			01.87	09.94		13.0460-7033.2	607033	20887 15,3 +/Zub	VW	
	1.0 1.1 1.3 1.3 D 1.4 D			10.81 10.81 10.81 08.86 08.90	09.94 07.83 09.94 09.94 09.94		24.0110-0151.1 24.0310-0151.1	410151 510151	239 10,0 8,0 +S +B 239 10,0 8,0 +S +B PD		
	1.3 G40			01.87	09.94		24.0120-0123.1 24.0320-0123.1	420123 520123	239 20,0 18,0 VL +S +B 239 20,0 18,0 VL +S +B PD		
	1.0 1.1 1.3 1.3 D 1.3 G40 1.4 D			10.81 10.81 10.81 08.86 01.87 08.90	09.94 07.83 09.94 09.94 09.94 09.94		83.7734-0290.3	330809	2	L=290	
	1.0 1.1 1.3 1.3 D 1.3 G40 1.4 D			10.81 10.81 10.81 08.86 01.87 08.90	09.94 07.83 09.94 09.94 09.94 09.94		83.7824-0180.3	330812	2	L=180	
	1.0 1.1 1.3	..-F-127903 ..-F-127903		10.81 10.81 10.81	07.83	- Bremskraftregler ³⁾ - Bremskraftregler ³⁾ - Bremskraftregler ³⁾	03.3214-0812.3 24.3214-0902.3	020011 020147	+ GG ⁴⁾ + ALU ⁵⁾	Rz 14,29 Rz 14,29	
	1.0 1.3 1.3 D 1.3 G40 1.4 D	..-F-127904 ..-F-127904		09.94 09.94 08.86 01.87 08.90	09.94 09.94 09.94 09.94 09.94	- Bremskraftregler ³⁾ - Bremskraftregler ³⁾ - Bremskraftregler ³⁾ - Bremskraftregler ³⁾ - Bremskraftregler ³⁾	03.3215-2311.3 24.3215-0903.3	020018 020154	+ GG ⁴⁾ + ALU ⁵⁾	Rz 15,87 Rz 15,87	
	1.0 1.1 1.3	..-F-127903 ..-F-127903		10.81 10.81 10.81	07.83	+ Bremskraftregler ⁶⁾ + Bremskraftregler ⁶⁾ + Bremskraftregler ⁶⁾	03.3217-2112.3 24.3217-0908.3	020027 020167	+ GG ⁴⁾ + ALU ⁵⁾	Rz 17,46 Rz 17,46	
	1.0 1.3 1.3 D 1.3 G40 1.4 D	..-F-127904 ..-F-127904		09.94 09.94 08.86 01.87 08.90	09.94 09.94 09.94 09.94 09.94	+ Bremskraftregler ⁶⁾ + Bremskraftregler ⁶⁾ + Bremskraftregler ⁶⁾ + Bremskraftregler ⁶⁾ + Bremskraftregler ⁶⁾	24.3219-0909.3	020188		Rz 19,05	
	1.0 1.1 1.3 1.3 D 1.3 G40 1.4 D			10.81 10.81 10.81 08.86 01.87 08.90	09.94 07.83 09.94 09.94 09.94 09.94		03.0137-0126.2 03.0137-9008.2	650126 669008		180 x 31 HEB Bremsbacken-Zubehör	
	1.0 1.1 1.3 1.3 D 1.3 G40 1.4 D			10.81 10.81 10.81 08.86 01.87 08.90	09.94 07.83 09.94 09.94 09.94 09.94		24.0218-0007.1 24.0218-0707.2	480003 480211		180/181 x 38,5 - Lager 180/181 x 38,5 + Lager	
	1.0 1.1 1.3	..-F-127903 ..-F-127903		10.81 10.81 10.81	07.83	- Bremskraftregler ³⁾ - Bremskraftregler ³⁾ - Bremskraftregler ³⁾	03.0520-0114.3	690114		14,29/180x31 TopKit	VW
	1.0 1.1	..-F-127903		10.81 10.81	07.83	+ Bremskraftregler ⁶⁾ + Bremskraftregler ⁶⁾	03.0420-0617.3 03.0520-3917.3	680617 693917	+ Rz GG ⁷⁾ + Rz ALU ⁸⁾	17,46/180x31 Kit 17,46/180x31 TopKit	VW VW

¹⁾ - booster unit / - servofreno / - servo-frein / - servofreno

²⁾ - booster unit / + servofreno / + servo-frein / + servofreno

³⁾ - brake pressure regulator / - correttore di frenata / - correcteur de freinage / - corrector de frenado

⁴⁾ - cast iron / + ghisa / + fonte grise / + fundición de gris

⁵⁾ - aluminium / + alluminio / + aluminium / + aluminio

⁶⁾ - brake pressure regulator / + correttore di frenata / + correcteur de freinage / + corrector de frenado

⁷⁾ - WC cast iron / + CR ghisa / + CR fontegrise / + CR fundición de gris

⁸⁾ - WC aluminium / + CR alluminio / + CR aluminium / + CR aluminio

⁹⁾ without alarm / senza dispositivo d'allarme / sans dispositif d'avertissement / sin dispositivo avisador

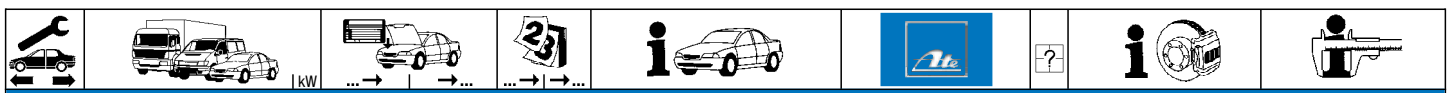

VOLKSWAGEN POLO II (81-94)

	1.3		..-F-127903	10.81	+ Bremskraftregler ¹⁾	03.0420-0617.3	680617	+ Rz GG ²⁾	17,46/180x31 Kit	VW
	1.0		..-F-127904		09.94 - Bremskraftregler ⁴⁾	03.0520-3917.3	693917	+ Rz ALU ³⁾	17,46/180x31 TopKit	VW
	1.3 D		..-F-127904		09.94 - Bremskraftregler ⁴⁾					
	1.3 G40			08.86	09.90 - Bremskraftregler ⁴⁾					
	1.4 D			01.87	09.94 - Bremskraftregler ⁴⁾					
				08.90	09.94 - Bremskraftregler ⁴⁾					
	1.0		..-F-127904		09.94 + Bremskraftregler ¹⁾	03.0520-1719.3	691719		19,05/180x31 TopKit	VW
	1.3		..-F-127904		09.94 + Bremskraftregler ¹⁾					
	1.3 D			08.86	09.90 + Bremskraftregler ¹⁾					
	1.3 G40			01.87	09.94 + Bremskraftregler ¹⁾					
	1.4 D			08.90	09.94 + Bremskraftregler ¹⁾					
	1.0		..-E-200000	10.81		24.3727-0146.2	580146	1 ↑	L=794	
	1.1		..-E-200000	10.81	07.83	24.3727-0103.2	580103	1 ↓	L=1960	
	1.3			10.81						
	1.0		..-F-000001		09.94	24.3727-0137.2	580137	1 ↑	L=1594	
	1.3		..-F-000001		09.94	24.3727-0129.2	580129	2 ↓	L=633	
	1.3 D			08.86	09.90					
	1.3 G40			01.87	09.94					
	1.4 D			08.90	09.94					
	1.0		..-F-000001		09.94	03.6584-0015.3	320109		BRL 8/4 (4)	ATE
	1.3		..-F-000001		09.94					
	1.3 D			08.86	09.90					
	1.3 G40			01.87	09.94					
	1.4 D			08.90	09.94					
	1.0			10.81	02.85	24.3728-0101.2	590101		L=607	
	1.1			10.81	07.83					
	1.3			10.81	02.85					
	1.0			03.85	09.94	24.3728-0118.2	590118		L=607	
	1.3			03.85	09.94					
	1.3 G40			01.87	09.94					

VOLKSWAGEN SCIROCCO I (74-83)

	1.1			08.77	07.79	03.2120-1531.3	010092		THz 20,64	ATE
	1.5			01.74	07.79					
	1.6			01.75	07.79					
	1.1			08.79	07.80	03.2120-1531.3	010092		THz 20,64	ATE
	1.3			08.79	07.83	03.2120-1491.3	010089		THz 20,64 + WE	ATE
	1.5			08.79	07.83					
	1.6			08.79	07.83					
	1.6 i			08.79	07.82	03.2120-1491.3	010089		THz 20,64 + WE	ATE
	1.8			08.82	07.83					
	1.1			01.74	07.79	03.3508-7504.3	310045	ohne Warneinrichtung ⁹⁾	Behälter	ATE
	1.5			01.74	07.79					
	1.6			01.75	07.77					
	1.6			01.75	07.79					
	1.6 i			01.76	07.79					
	1.1			01.74	07.80	+ Schwimmsättel ⁵⁾	11.0441-4402.2	250014	Dichtungssatz	ATE
	1.3			08.79	07.80	+ Schwimmsättel ⁵⁾				
	1.5			01.74	07.80	+ Schwimmsättel ⁵⁾				
	1.6			01.75	07.80	+ Schwimmsättel ⁵⁾				
	1.7			08.80	07.83	+ Ⓞ / + Schwimmsättel ⁶⁾				
	1.6 i			01.76	07.80	+ Schwimmsättel ⁵⁾	11.0441-4402.2	250014	Dichtungssatz	ATE
	1.1			08.78	07.80	+ Faustsättel ⁷⁾	11.0441-4808.2	250022	Dichtungssatz	ATE
	1.3			08.79	07.83	+ Faustsättel ⁷⁾	11.0101-4801.2	260006	Hülsensatz	ATE
	1.5			08.78	07.83	+ Faustsättel ⁷⁾	24.0102-4801.2	260085	Hülsensatz+Schrauben	ATE
	1.6			08.78	07.83	+ Faustsättel ⁷⁾				
	1.6 i			04.79	07.82	+ Faustsättel ⁷⁾				
	1.7			08.80	07.83	+ Ⓞ / + Faustsättel ⁸⁾				
	1.8			08.82	07.83	+ Faustsättel ⁷⁾				
	1.1			01.74	07.80	+ Schwimmsättel ⁵⁾	13.0460-4029.2	604029	20228 18,5	ATE
	1.3			08.79	07.80	+ Schwimmsättel ⁵⁾				
	1.5			01.74	07.80	+ Schwimmsättel ⁵⁾				
	1.6			01.75	07.80	+ Schwimmsättel ⁵⁾				
	1.7			08.80	07.83	+ Ⓞ / + Schwimmsättel ⁶⁾				
	1.6 i			01.76	07.80	+ Schwimmsättel ⁵⁾	13.0460-4028.2	604028	20228 15,3	ATE
	1.1			08.78	07.80	+ Faustsättel ⁷⁾	13.0460-7032.2	607032	20887 19,7 +/Zub	VW
	1.3			08.79	07.83	+ Faustsättel ⁷⁾				
	1.5			08.78	07.83	+ Faustsättel ⁷⁾				
	1.6			08.78	07.83	+ Faustsättel ⁷⁾				
	1.7			08.80	07.83	+ Ⓞ / + Faustsättel ⁸⁾				
	1.6 i			04.79	07.82	+ Faustsättel ⁷⁾	13.0460-7033.2	607033	20887 15,3 +/Zub	VW
	1.8			08.82	07.83					
	1.1			01.74	07.80		24.0112-0106.1	412106	239 12,0 10,0 +S +B	
	1.3			08.79	07.83		24.0312-0106.1	512106	239 12,0 10,0 +S +B PD	
	1.5			01.74	07.83					
	1.6			01.75	07.83					
	1.7			08.80	07.83	+ Ⓞ				
	1.6 i			01.76	07.82		24.0120-0123.1	420123	239 20,0 18,0 V L +S +B	
	1.8			08.82	07.83		24.0320-0123.1	520123	239 20,0 18,0 V L +S +B PD	

¹⁾ + brake pressure regulator / + correttore di frenata / + correcteur de freinage / + corrector de frenado

²⁾ + WC cast iron / + CR ghisa / + CR fontegrise / + CR fundición de gris

³⁾ + WC aluminium / + CR alluminio / + CR aluminium / + CR aluminio

⁴⁾ - brake pressure regulator / - correttore di frenata / - correcteur de freinage / - corrector de frenado

⁵⁾ + floating calipers / + pinze flottante / + étriers flottant / + pinzas flotante

⁶⁾ + Ⓞ / + floating calipers / + Ⓞ / + pinze flottanti / + Ⓞ / + étriers flottant / + Ⓞ / + pinza flotante

⁷⁾ + fist type calipers / + pinza freno flottante / + étriers à griffe / + pinza de puno

⁸⁾ + Ⓞ / + fist type calipers / + Ⓞ / + pinza flottante / + Ⓞ / + étriers à griffe / + Ⓞ / + pinza de puno

⁹⁾ without alarm / senza dispositivo d'allarme / sans dispositif d'avertissement / sin dispositivo avisador

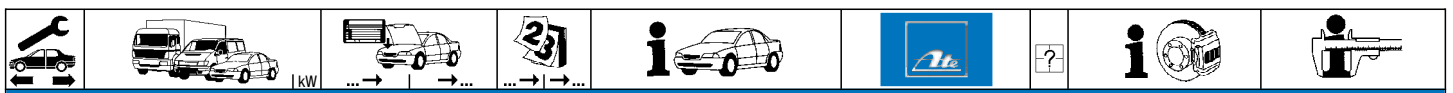

VOLKSWAGEN SCIROCCO I (74-83)

	1.1			01.74	07.80	83.6104-0325.3	330246	2		L=325	ATE							
	1.5			01.74	07.80													
	1.6			01.75	07.80													
	1.1			11.78	07.80													
	1.3			08.79	07.83													
	1.5			11.78	07.83													
	1.6			11.78	07.83													
	1.7			08.80	07.83													
1.8			08.82	07.83	+ Ⓟ													
	1.1			01.74	07.80	24.5201-0164.3	331414	2		L=164								
	1.3			08.79	07.83													
	1.5			01.74	07.83													
	1.6			01.75	07.83													
	1.7			08.80	07.83													
	1.8			08.82	07.83							+ Ⓟ						
		1.1			01.74							07.80	03.3214-0812.3	020011		+ GG ¹⁾	Rz 14,29	
		1.3			08.79							07.81						
1.5				01.74	07.81													
1.6				01.75	07.81													
1.3				08.81	07.83													
1.5				01.74	07.81													
1.6				01.75	07.81													
1.6 i				01.76	07.82													
1.7			08.80	07.83	+ Ⓟ													
1.8			08.82	07.83	+ Ⓟ													
	1.1			01.74	07.78	03.0137-9006.2	669006		- autom. Nachstellung ⁵⁾	Bremsbacken-Zubehör								
	1.5			01.74	07.78													
	1.6			01.75	07.78													
	1.6 i			01.76	07.78													
	1.1			08.78	07.80													
	1.3			08.79	07.83													
	1.5			08.78	07.83													
	1.6			01.77	07.83													
1.6 i			08.78	07.82	+ Ⓟ													
1.7			08.80	07.83	+ Ⓟ													
1.8			08.82	07.83	+ Ⓟ													
	1.1			01.74	07.80	24.0218-0007.1	480003			180/181 x 38,5 - Lager								
	1.3			08.79	07.83													
	1.5			01.74	07.83													
	1.6			01.74	07.83													
	1.7			08.80	07.83													
	1.8			08.82	07.83							+ Ⓟ						
		1.1			08.78							07.80	03.0520-0114.3	690114			14,29/180x31 TopKit	VW
		1.3			08.79							07.81						
1.5				08.78	07.81													
1.6				08.78	07.81													
1.3				08.81	07.83													
1.5				08.78	07.81													
1.6				08.78	07.81													
1.6 i				08.78	07.82													
1.7			08.80	07.83	+ Ⓟ													
1.8			08.82	07.83	+ Ⓟ													
	1.1			01.74	07.80	24.3727-0102.2	580102	2 Ⓡ		L=1690								
	1.3			08.79	07.83													
	1.5			01.74	07.83													
	1.6			01.75	07.83													
	1.7			08.80	07.83													
	1.8			08.82	07.83							+ Ⓟ						
		1.1			08.76							07.80	03.6565-0101.3	320097			BRL 6/5 (4)	ATE
		1.3			08.79							07.83						
1.5				08.76	07.83													
1.6				08.76	07.83													
1.7				08.80	07.83													
1.8				08.82	07.83	+ Ⓟ												
		1.1			09.75	07.80	24.3728-0107.2	590107			L=1055							
		1.3			08.79	07.83												
	1.5			09.75	07.83													
	1.6			09.75	07.83													
	1.6 i			01.76	07.82													
	1.7			08.80	07.83													
	1.8			08.82	07.83	+ Ⓟ												

VOLKSWAGEN SCIROCCO II (84-92)

	1.3	◀	53-E-022074	08.83		03.2120-1491.3	010089			THz 20,64 + WE	ATE
	1.3	▶	53-E-022075		07.84						
	1.6	▶	53-E-022075	53-E-022074	08.83						
	1.6	▶	53-E-022075		07.92						
	1.8	▶	53-E-022075	53-E-022074	08.83						
	1.8	▶	53-E-022075		07.92						
	1.8 16V	▶	53-E-022075		07.92						
	1.3	▶	53-E-022075		07.84						
	1.6	▶	53-E-022075	53-L-010000							
	1.8	▶	53-E-022075	53-L-010000							
	1.6	▶	53-L-010001		07.92	03.2120-2031.3	010106			THz 20,64	ATE
	1.8	▶	53-L-010001		07.92						
	1.6	▶	53-L-010001		07.92						
	1.8	▶	53-L-010001		07.92						

1) + cast iron / + ghisa / + fonte grise / + fundición de gris

2) + aluminium / + alluminio / + aluminium / + aluminio

3) + manual transmission / + scatola cambio velocità / + transmission mécanique / + cambio de velocidad

4) + autom. transmission / + scatola cambio automatico / + transmission automatique / + cambio automático

5) - automatic adjustment / - correzione automatica / - ajustage automatique / - reajuste automatico

6) + WC cast iron / + CR ghisa / + CR fonte grise / + CR fundición de gris

7) + WC aluminium / + CR alluminio / + CR aluminium / + CR aluminio

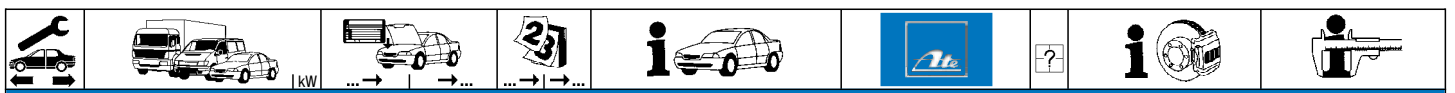

































VOLKSWAGEN SCIROCCO II (84-92)											
	1.8 16V			10.85	07.92		03.2122-9812.3	010161		Thz 22,20	ATE
	1.3		53-E-022074	08.83			11.0441-4808.2	250022		Dichtungssatz	ATE
	1.6		53-E-022074	08.83			11.0101-4801.2	260006		Hülsensatz	ATE
	1.8		53-E-022074	08.83			24.0102-4801.2	260085		Hülsensatz+Schrauben	ATE
	1.3	53-E-022075			07.84		11.0441-4808.2	250022		Dichtungssatz	ATE
	1.6	53-E-022075			07.92		11.0101-4801.2	260006		Hülsensatz	ATE
	1.8	53-E-022075			07.92		24.0102-4801.2	260085		Hülsensatz+Schrauben	ATE
	1.8 16V			10.85	07.92		24.3541-1609.5	240039		D=54, - Halter	LUC
							24.3541-1610.5	240040		D=54, - Halter	LUC
							24.0101-4301.2	260047		Bremssattel-Zubehör	LUC
							11.0101-5403.2	260010		Faltenbalgsatz	LUC
							13.0460-7032.2	607032		20887 19,7 +/Zub	VW
							13.0460-7033.2	607033		20887 15,3 +/Zub	VW
	1.8 16V			10.85	07.92		13.0460-2957.2	602957		20168 16,0 /S	LUC
	1.3			08.83	07.84		24.0112-0106.1	412106		239 12,0 10,0 +S +B	
	1.6			08.83	07.92		24.0312-0106.1	512106		239 12,0 10,0 +S +B PD	
	1.8			08.83	07.92		24.0120-0123.1	420123		239 20,0 18,0 V L +S +B	
							24.0320-0123.1	520123		239 20,0 18,0 V L +S +B PD	
	1.8 16V			10.85	07.92		24.0120-0128.1	420128		256 20,0 18,0 V L +S +B	
							24.0320-0128.1	520128		256 20,0 18,0 V L +S +B PD	
	1.3			08.83	07.84		24.5170-0315.3	331309	2	L=315	
	1.6			08.83	07.92						
	1.8			08.83	07.92						
	1.8 16V			10.85	07.92						
	1.8 16V			10.85	07.92		24.3364-1605.5	240011		D=36, - Halter	LUC
							24.3364-1606.5	240012		D=36, - Halter	LUC
							24.0101-3601.2	260044		Bremssattel-Zubehör	LUC
							11.0101-5403.2	260010		Faltenbalgsatz	LUC
	1.8 16V			10.85	07.92		13.0460-2937.2	602937		20961 15,2 /Zub/S	LUC
							13.0460-0419.2	610419		Belagsatz-Zubehör	LUC
	1.8 16V			10.85	07.92		24.0110-0111.1	410111		ohne Sensorring ¹⁾	
							24.0110-0275.2	410275		mit Sensorring ²⁾	
	1.3			08.83	07.84		83.7824-0180.3	330812	2	L=180	
	1.6			08.83	07.92						
	1.8			08.83	07.92						
	1.8 16V			10.85	07.92		24.5170-0161.3	331308	2	L=161	
	1.3		53-E-022074	08.83		- Bremskraftregler ³⁾	03.3214-0812.3	020011	+ GG ⁴⁾	Rz 14,29	
	1.6		53-E-022074	08.83		- Bremskraftregler ³⁾	24.3214-0902.3	020147	+ ALU ⁵⁾	Rz 14,29	
	1.8		53-E-022074	08.83		- Bremskraftregler ³⁾					
	1.3			08.83	07.84	+ Bremskraftregler ⁶⁾	03.3217-2112.3	020027	+ GG ⁴⁾	Rz 17,46	
	1.6			08.83	07.92	+ Bremskraftregler ⁶⁾	24.3217-0908.3	020167	+ ALU ⁵⁾	Rz 17,46	
	1.8			08.83	07.92	+ Bremskraftregler ⁶⁾					
	1.3			08.83	07.84		03.0137-0126.2	650126		180 x 31 HEB	
	1.6			08.83	07.92		03.0137-9008.2	669008		Bremsbacken-Zubehör	
	1.8			08.83	07.92						
	1.3			08.83	07.84		24.0218-0007.1	480003		180/181 x 38,5 - Lager	
	1.6			08.83	07.92		24.0218-0707.2	480211		180/181 x 38,5 + Lager	
	1.8			08.83	07.92						
	1.3		53-E-022074	08.83		- Bremskraftregler ³⁾	03.0520-0114.3	690114		14,29/180x31 TopKit	VW
	1.6		53-E-022074	08.83		- Bremskraftregler ³⁾					
	1.8		53-E-022074	08.83		- Bremskraftregler ³⁾					
	1.3			08.83	07.84	+ Bremskraftregler ⁶⁾	03.0420-0617.3	680617	+ Rz GG ⁷⁾	17,46/180x31 Kit	VW
	1.6			08.83	07.92	+ Bremskraftregler ⁶⁾	03.0520-3917.3	693917	+ Rz ALU ⁸⁾	17,46/180x31 TopKit	VW
	1.8			08.83	07.92	+ Bremskraftregler ⁶⁾					
	1.3			08.83	07.84		24.3727-0102.2	580102	2	L=1690	
	1.6			08.83	07.92						
	1.8			08.83	07.92						
	1.3		53-E-060000	08.83			24.3728-0107.2	590107		L=1055	
	1.6			08.83	07.92		24.3728-0109.2	590109		L=874	
	1.8			08.83	07.92						

VOLKSWAGEN TRANSPORTER (Typ 2) (60-79)

	1.6 Bus + Kasten	2142110466			04.79		03.6850-0502.4	300044		9"	ATE	
	1.8 Bus + Kasten				08.73	07.75						
	2.0 Bus + Kasten				08.75	04.79						
	1.6 Bus + Kasten				05.79	09.79		03.6850-5402.4	300055	9"	ATE	
	2.0 Bus + Kasten				05.79	07.79						
	1.1 (44593)	227019488			12.62		- Bremsgerät/ - (S) ⁹⁾	03.2122-0704.3	010134	Thz 22,20	ATE	
	1.2 (21.23)	227019488	227072465				- Bremsgerät/ - (S) ⁹⁾					
	1.2 (21.23)	227072466			07.67		- Bremsgerät/ - (S) ⁹⁾	03.2122-0903.3	010136	Thz 22,20	ATE	
	1.2 (22.24.25.28)				11.62	07.69	- Bremsgerät/ - (S) ⁹⁾					
	1.5 (21.23)				02.62	12.68	- Bremsgerät/ - (S) ⁹⁾					
	1.5 (22.24.25.28)				11.62	07.67	- Bremsgerät/ - (S) ⁹⁾					
	1.5 (26)				06.66	07.69	- Bremsgerät/ - (S) ⁹⁾					
	1.6 (21.23)				08.64	12.68	- Bremsgerät/ - (S) ⁹⁾					
	1.6 (22.24.25.28)				06.66	07.67	- Bremsgerät/ - (S) ⁹⁾					
1.5 (26)				08.69	07.70	- Bremsgerät/ - (S) ⁹⁾	03.2122-2905.3	010141		- Bremslichtschalter ¹⁰⁾	Thz 22,20	ATE

1) without sensor ring / senza sensori / sans secours ABS / sin anillo sensor ABS
 2) with sensor ring / con sensori / avec secours ABS / con anillo sensor ABS
 3) - brake pressure regulator / - correttore di frenata / - correcteur de freinage / - corrector de frenado
 4) + cast iron / + ghisa / + fonte grise / + fundición de gris
 5) + aluminium / + alluminio / + aluminium / + aluminio
 6) + brake pressure regulator / + correttore di frenata / + correcteur de freinage / + corrector de frenado
 7) + WC cast iron / + CR ghisa / + CR fontgrise / + CR fundición de gris
 8) + WC aluminium / + CR alluminio / + CR aluminium / + CR aluminio
 9) - booster unit/ - (S) / - servofreno/ - (S) / - servo-frein/ - (S) / - servofreno/ - (S)
 10) - stop light switch / - interruttore luce di arresto / - contacteur stop / - interruptor de luz de freno

								
VOLKSWAGEN TRANSPORTER (Typ 2) (60-79)								
	1.6 Bus + Kasten 1.7 Bus + Kasten 1.8 Bus + Kasten 2.0 Bus + Kasten		08.70 07.79 08.71 12.73 08.73 07.75 08.75 07.79	- Bremsgerät/ - (S) 1) - Bremsgerät/ - (S) 1) - Bremsgerät/ - (S) 1) - Bremsgerät/ - (S) 1)	03.2120-8411.3	010125		THz 20,64 ATE
	1.6 Bus + Kasten 1.7 Bus + Kasten 1.8 Bus + Kasten 2.0 Bus + Kasten		08.70 07.79 08.70 12.73 08.73 07.75 08.75 07.79	+ Bremsgerät 2) + Bremsgerät 2) + Bremsgerät 2) + Bremsgerät 2)	03.2123-2604.3	010178		THz 23,81 + WE ATE
	1.6 Bus + Kasten 1.7 Bus + Kasten		08.70 07.72 08.71 07.72		13.0441-5415.2	250116		Dichtungssatz ATE
	1.6 Bus + Kasten 1.7 Bus + Kasten 1.8 Bus + Kasten 2.0 Bus + Kasten		08.72 07.79 08.72 12.73 08.73 07.75 08.75 07.79		13.2541-8002.2 13.2541-8001.2 13.0441-5416.2	210111 210110 250117	 	D=54 D=54 Dichtungssatz ATE ATE ATE
	1.6 Bus + Kasten 1.7 Bus + Kasten		08.70 07.72 08.71 07.72		13.0460-6027.2	606027		20011 15,0 ATE
	1.6 Bus + Kasten 1.7 Bus + Kasten 1.8 Bus + Kasten 2.0 Bus + Kasten		08.72 07.79 08.72 12.73 08.73 07.75 08.75 07.79		13.0460-6028.2 13.0460-0157.2	606028 610157		20011 18,5 Belagsatz-Zubehör ATE ATE
	1.6 Bus + Kasten 1.7 Bus + Kasten 1.8 Bus + Kasten 2.0 Bus + Kasten		08.72 07.79 08.72 12.73 08.73 07.75 08.75 07.79		24.0113-0132.1	413132		278 13,0 11,0
	1.5 (26) 1.6 Bus + Kasten 1.7 Bus + Kasten 1.8 Bus + Kasten 2.0 Bus + Kasten		08.68 10.70 08.70 07.79 08.71 12.73 08.73 07.75 08.75 07.79		24.5224-0295.3	331261	2	L=295
	1.2 (21.23) 1.2 (22.24.25.28) 1.5 (21.23) 1.5 (22.24.25.28) 1.5 (26) 1.6 (21.23) 1.6 (22.24.25.28)		08.63 07.67 08.63 08.66 08.63 12.68 08.63 07.67 06.66 07.70 08.64 12.68 06.66 07.67		24.2725-0903.3 24.2725-0904.3	020145 020146	2  2 	Rz 25,40 Rz 25,40
	1.5 (26) 1.6 Bus + Kasten 1.7 Bus + Kasten 1.8 Bus + Kasten 2.0 Bus + Kasten		08.68 10.70 08.70 07.79 08.71 12.73 08.73 07.75 08.75 07.79		83.6101-0250.3 24.5224-0240.3	330203 331260	 	L=250 L=240
	1.1 (44593) 1.2 (21.23) 1.2 (22.24.25.28) 1.5 (21.23) 1.5 (22.24.25.28) 1.5 (26) 1.6 (21.23) 1.6 (22.24.25.28) 1.6 Bus + Kasten		01.60 12.62 01.60 07.67 11.62 08.66 02.62 12.68 11.62 07.67 06.66 10.70 08.64 12.68 06.66 07.67 08.70 07.71		03.3222-0801.3	020067		Rz 22,20
	1.6 Bus + Kasten 1.7 Bus + Kasten 1.8 Bus + Kasten 2.0 Bus + Kasten		08.71 07.79 08.71 12.73 08.73 07.75 08.75 07.79		03.3223-1112.3	020092		Rz 23,81
	1.6 Bus + Kasten 1.7 Bus + Kasten 1.8 Bus + Kasten 2.0 Bus + Kasten		08.73 07.79 08.73 12.73 08.73 07.75 08.75 07.79		03.0137-0055.2 03.0137-9024.2	650055 669024	+ autom. Nachstellung 3)	252 x 56 Bremsbacken-Zubehör
	1.6 Bus + Kasten 1.7 Bus + Kasten 1.8 Bus + Kasten 2.0 Bus + Kasten		08.70 04.79 08.71 12.73 08.73 07.75 08.75 04.79		24.0225-2001.2	480045		252/253,5 x 60
	1.6 Bus + Kasten 2.0 Bus + Kasten		05.79 07.79 05.79 07.79		24.0225-2002.2	480046		252/253,5 x 61
	1.6 Bus + Kasten 1.7 Bus + Kasten 1.8 Bus + Kasten 2.0 Bus + Kasten		08.71 05.79 08.71 12.73 08.73 07.75 08.75 05.79		24.3727-0107.2	580107	2 	L=2958
	1.6 Bus + Kasten 2.0 Bus + Kasten		06.79 07.79 06.79 07.79		24.3727-0109.2	580109	2 	L=1455
	1.6 Bus 2.0 Bus + Kasten	34	05.79 07.79 05.79 07.79	- luftgekühlt 4)	03.2419-8212.3	030020		Gz 19,05
	1.6 Bus 2.0 Bus + Kasten	34	05.79 07.79 05.79 07.79	- luftgekühlt 4)	03.2525-2711.3 03.0450-2510.2	040030 082510		Nz 25,40 Nz Reparatursatz
	1.6 Bus 2.0 Bus + Kasten	34	05.79 07.79 05.79 07.79	- luftgekühlt 4)	24.5803-0325.3	330051		L=325
	1.6 Bus 1.6 Kasten 2.0 Bus + Kasten	37	05.79 07.79 05.79 07.79 05.79 07.79	+ luftgekühlt 5)	24.3728-0123.2	590123		L=3852

1) - booster unit/ - (S) / - servofreno/ - (S) / - servo-frein/ - (S) / - servofreno/ - (S)

2) + booster unit / + servofreno / + servo-frein / + servofreno

3) + automatic adjustment / + correzione automatica / + ajustage automatique / + reajuste automático

4) - air cooled / - raffreddato ad aria / - refroidi par air / - refrigeración por aire

5) + air cooled / + raffreddato ad aria / + refroidi par air / + refrigeración por aire

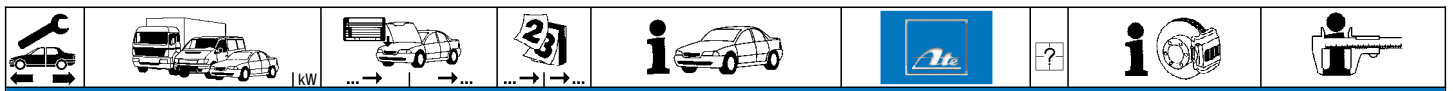



















VOLKSWAGEN TRANSPORTER (Typ 2) (79-92)

	1.6 1.6 D 1.6 TD 1.6 TD Syncro 1.7 D 1.9 1.9 Syncro 2.0 2.1 2.1 Syncro			07.79 01.81 08.84 03.86 10.86 08.82 11.84 05.79 08.85 08.85	12.82 07.87 09.92 09.92 09.92 09.92 09.92 04.86 09.92 09.92	03.6850-5402.4	300055		9"	ATE
	1.6 1.6 D 1.9 2.0		24-D-200000 24-D-200000 24-D-200000 24-D-200000	07.79 01.81 08.82 05.79		03.2120-0851.3	010082		THz 20,64	ATE
	1.6 1.6 D 1.6 TD 1.6 TD Syncro 1.7 D 1.9 1.9 Syncro 2.0 2.1 2.1 Syncro			07.79 01.81 08.84 03.86 10.86 08.82 11.84 05.79 08.85 08.85	12.82 07.87 09.92 09.92 09.92 09.92 09.92 04.86 09.92 09.92	03.2123-0291.3 03.2123-0271.3	010165 010164		THz 23,81 THz 23,81 + WE	ATE ATE
	1.6 1.6 D 1.6 TD 1.9 2.0		24-G-200000 24-G-200000 24-G-200000 24-G-200000	07.79 01.81 08.84 08.82 05.79	+ Festsättel ³⁾ + Festsättel ³⁾ + Festsättel ³⁾ + Festsättel ³⁾	13.2541-8002.2 13.2541-8001.2 13.0441-5416.2	210111 210110 250117		D=54 D=54 Dichtungssatz	ATE ATE ATE
	1.6 D 1.6 TD 1.6 TD Syncro 1.7 D 1.9 1.9 Syncro 2.0 2.1 2.1 Syncro			08.85 08.85 03.86 08.85 08.85 11.84 08.85 08.85 08.85	07.87 09.92 09.92 09.92 09.92 09.92 04.86 09.92 09.92	24.3601-1601.5 24.3601-1602.5 11.0101-5403.2	240203 240204 260010		D=60, - Halter D=60, - Halter Faltenbalgsatz	LUC LUC LUC
	1.6 TD 1.6 TD Syncro 1.7 D 1.9 1.9 Syncro 2.1 2.1 Syncro	24-K-000001 24-J-105001 24-K-000001 24-K-000001 24-J-105001 24-K-000001 24-J-105001		09.92 09.92 09.92 09.92 09.92 09.92 09.92	+ Faustsättel ⁴⁾ + Faustsättel ⁴⁾ + Faustsättel ⁴⁾ + Faustsättel ⁴⁾ + Faustsättel ⁴⁾ + Faustsättel ⁴⁾ + Faustsättel ⁴⁾	24.3601-1709.5 24.3601-1710.5 11.0441-6003.2 11.0101-6004.2	240275 240276 250037 260014		D=60, - Halter D=60, - Halter Dichtungssatz Hülzensatz	LUC LUC ATE
	1.6 1.6 D 1.6 TD 1.9 2.0		24-G-200000 24-G-200000 24-G-200000 24-G-200000	07.79 01.81 08.84 08.82 05.79	+ Festsättel ³⁾ + Festsättel ³⁾ + Festsättel ³⁾ + Festsättel ³⁾ + Festsättel ³⁾	13.0460-6028.2 13.0460-0157.2	606028 610157		20011 18,5 Belagsatz-Zubehör	ATE ATE
	1.6 D 1.6 TD 1.6 TD Syncro 1.7 D 1.9 1.9 Syncro 2.0 2.1 2.1 Syncro			08.85 08.85 03.86 08.85 08.85 11.84 08.85 08.85 08.85	07.87 09.92 09.92 09.92 09.92 09.92 04.86 09.92 09.92	13.0460-2903.2	602903		20979 19,4 /S	LUC
	1.6 1.6 D 1.6 TD 1.9 2.0		24-G-200000 24-G-200000 24-G-200000 24-G-200000	07.79 01.81 08.84 08.82 05.79	+ Festsättel ³⁾ + Festsättel ³⁾ + Festsättel ³⁾ + Festsättel ³⁾ + Festsättel ³⁾	24.0113-0142.1	413142		278 13,0 11,0	
	1.6 D 1.6 TD 1.7 D 1.9 2.0 2.1			08.85 08.85 08.85 08.85 08.85 08.85	07.87 09.92 09.92 09.92 04.86 09.92	24.0116-0104.1	416104		258 16,0 13,0 +B	
	1.6 TD Syncro 1.9 Syncro 2.1 Syncro			03.86 11.84 08.85	09.92 09.92 09.92	24.0116-0109.1	416109		258 16,0 13,0	
	1.6 1.6 D 1.6 TD 1.9 2.0			07.79 01.81 08.84 08.82 05.79	12.82 07.85 07.85 07.85 07.85	83.7824-0383.3	330856	2	L=380	
	1.6 D 1.6 TD 1.7 D 1.9 2.0 2.1		24-G-200000 24-G-200000 24-G-200000 24-G-200000 24-G-200000	08.85 08.85 08.85 08.85 08.85	+ Festsättel ³⁾ + Festsättel ³⁾ + Festsättel ³⁾ + Festsättel ³⁾ + Festsättel ³⁾	24.5224-0295.3	331261	2	L=295	
	1.6 D			08.85	07.87	24.5224-0440.3	331378	2	L=445	

1) - booster unit / - servofreno / - servo-frein / - servofreno
 2) - ABS/ + booster unit / - ABS/ + servofreno / - ABS/ + servo-frein / - ABS/ + servofreno
 3) + fixed calipers / + pinze freno fisse / + étriers fixes / + pinza de fija
 4) + fist type calipers / + pinza freno flottante / + étriers à griffe / + pinza de puno
 5) + 14" wheel / + ruota 14" / + roue 14" / + rueda 14"























VOLKSWAGEN TRANSPORTER (Typ 2) (79-92)										
										
	1.6 TD 1.6 TD Syncro 1.7 D 1.9 1.9 Syncro 2.0 2.1 2.1 Syncro			08.85 09.92 + Faustsättel ¹⁾ 03.86 09.92 08.85 09.92 + Faustsättel ¹⁾ 08.85 09.92 + Faustsättel ¹⁾ 11.84 09.92 08.85 04.86 + Faustsättel ¹⁾ 08.85 09.92 + Faustsättel ¹⁾ 08.85 09.92		24.5224-0440.3	331378	2		L=445
	1.6 1.6 D 1.6 TD 1.6 TD Syncro 1.7 D 1.9 1.9 Syncro 2.0 2.1 2.1 Syncro			07.79 12.82 01.81 07.87 08.84 09.92 03.86 09.92 10.86 09.92 08.82 09.92 11.84 09.92 05.79 04.86 08.85 09.92 08.85 09.92		83.7824-0180.3	330812	2		L=180
	1.6 1.6 D 1.6 TD 1.6 TD Syncro 1.7 D 1.9 1.9 Syncro 2.0 2.1 2.1 Syncro			07.79 12.82 01.81 07.87 08.84 09.92 03.86 09.92 + 14" Rad ²⁾ 10.86 09.92 08.82 09.92 11.84 09.92 + 14" Rad ²⁾ 05.79 04.86 08.85 09.92 08.85 09.92 + 14" Rad ²⁾		03.3223-1112.3	020092			Rz 23,81
	1.6 1.6 D 1.6 TD 1.6 TD Syncro 1.7 D 1.9 1.9 Syncro 2.0 2.1 2.1 Syncro			07.79 12.82 01.81 07.87 08.84 09.92 03.86 09.92 + 14" Rad ²⁾ 10.86 09.92 08.82 09.92 11.84 09.92 + 14" Rad ²⁾ 05.79 04.86 08.85 09.92 08.85 09.92 + 14" Rad ²⁾		03.0137-0148.2 03.0137-9035.2	650148 669035			252 x 56 HEB Bremsbacken-Zubehör
	1.6 TD Syncro 1.9 Syncro 2.1 Syncro	24-J-000001 24-J-000001 24-J-000001		09.92 + 16" Rad ³⁾ 09.92 + 16" Rad ³⁾ 09.92 + 16" Rad ³⁾		03.0137-0252.2 03.0137-9152.2	650252 669152			270 x 66 HEB Bremsbacken-Zubehör
	1.6 1.6 D 1.6 TD 1.6 TD Syncro 1.7 D 1.9 1.9 Syncro 2.0 2.1 2.1 Syncro			07.79 12.82 01.81 07.87 08.84 09.92 03.86 09.92 + 14" Rad ²⁾ 10.86 09.92 08.82 09.92 11.84 09.92 + 14" Rad ²⁾ 05.79 04.86 08.85 09.92 08.85 09.92 + 14" Rad ²⁾		24.0225-2002.2	480046			252/253,5 x 61
	1.6 TD Syncro 1.9 Syncro 2.1 Syncro	24-J-000001 24-J-000001 24-J-000001		09.92 + 16" Rad ³⁾ 09.92 + 16" Rad ³⁾ 09.92 + 16" Rad ³⁾		24.0227-0003.1	480145			270/271,5 x 75,5
	1.6 1.6 D 1.6 TD 1.6 TD Syncro 1.7 D 1.9 1.9 Syncro 2.0 2.1 2.1 Syncro			07.79 12.82 01.81 07.87 08.84 09.92 03.86 09.92 + 14" Rad ²⁾ 10.86 09.92 08.82 09.92 11.84 09.92 + 14" Rad ²⁾ 05.79 04.86 08.85 09.92 08.85 09.92 + 14" Rad ²⁾		03.0420-0423.3	680423			23,81/252x56 Kit ATE
	1.6 1.6 D 1.6 TD 1.7 D 1.9 2.0 2.1			07.79 12.82 01.81 07.87 08.84 09.92 10.86 09.92 08.82 09.92 05.79 04.86 08.85 09.92		24.3727-0109.2	580109	2 ↓		L=1455
	1.6 D 1.6 TD 1.6 TD Syncro 1.7 D 1.9 1.9 Syncro 2.0 2.1 2.1 Syncro			01.81 07.87 08.84 09.92 03.86 09.92 10.86 09.92 08.82 09.92 11.84 09.92 05.79 04.86 - luftgekühlt ⁴⁾ 08.85 09.92 08.85 09.92		03.2419-8212.3	030020			Gz 19,05
	1.6 D 1.6 TD 1.6 TD Syncro 1.7 D 1.9 1.9 Syncro			01.81 07.87 08.84 09.92 03.86 09.92 10.86 09.92 08.82 09.92 11.84 09.92		03.2525-2711.3 03.0450-2510.2	040030 082510			Nz 25,40 Nz Reparatursatz

¹⁾ + fist type calipers / + pinza freno flottante / + étriers à griffe / + pinza de puno

²⁾ + 14" wheel / + ruota 14" / + roue 14" / + rueda 14"

³⁾ + 16" wheel / + ruota 16" / + roue 16" / + rueda 16"

⁴⁾ - air cooled / - raffreddato ad aria / - refroidi par air / - refrigeración por aire











VOLKSWAGEN TRANSPORTER (Typ 2) (79-92)												
	2.0 2.1 2.1 Syncro			05.79 08.85 08.85	04.86 09.92 09.92	- luftgekühlt ¹⁾	03.2525-2711.3 03.0450-2510.2	040030 082510			Nz 25,40 Nz Reparatursatz	
	1.6 D 1.6 TD 1.7 D 1.9 2.0 2.1			01.81 08.84 10.86 08.82 05.79 08.85	07.87 09.92 09.92 09.92 04.86 09.92	- luftgekühlt ¹⁾	24.5803-0325.3	330051			L=325	
	1.6 2.0	37		07.79 05.79	12.82 12.82	+ luftgekühlt ²⁾	24.3728-0123.2	590123			L=3852	
VOLKSWAGEN TYP 181 (69-79)												
	1.5 1.6 1.6			08.69 08.70 08.72	07.70 07.72 02.79		03.2119-8511.3 03.2119-8711.3 03.2119-8711.3	010062 010064 010064			THz 19,05 THz 19,05 + WE THz 19,05 + WE	ATE ATE ATE
	1.5 1.6			08.69 08.70	07.70 07.72		03.2119-8611.3	010063			THz 19,05	ATE
	1.5 1.6			08.69 08.70	07.70 02.79		24.5171-0393.3	331311	2		L=393	
	1.5 1.6			08.69 08.70	07.70 02.79		03.3222-5211.3	020081			Rz 22,20	
	1.5 1.6			08.69 08.70	07.70 02.79		03.0137-0041.2 03.0137-9229.2	650041 669229			230 x 40 Bremsbacken-Zubehör	ATE ATE
	1.5 1.6			08.69 08.70	07.70 02.79		24.5224-0240.3	331260	2		L=240	
	1.6			03.73	02.79		03.3217-1811.3	020026			Rz 17,46	
	1.6	1832346255			02.79		03.0137-0041.2	650041			230 x 40	ATE
	1.6	1832346255			02.79		03.0420-2917.3	682917			17,46/230x40 Kit	ATE
VOLVO 66 (75-80)												
	1.1 L/DL 1.3 DL/GL			07.75 07.75	12.80 12.80		13.0460-3010.2	603010			20009 15,0	ATE
	1.1 L/DL 1.3 DL/GL			07.75 07.75	12.80 12.80		83.6104-0220.3	330474	2		L=220	
	1.1 L/DL 1.3 DL/GL			07.75 07.75	12.80 12.80		03.0137-9173.2	669173			Bremsbacken-Zubehör	
VOLVO 140 Limousine (68-75)												
	1.8 (142) 1.8 (144) 2.0 (142) 2.0 (144)	358188 381525 358188 381525		08.75 08.75 08.75 08.75	+ E+F-Motor/ + Servolenkung ³⁾ + E+F-Motor/ + Servolenkung ³⁾ + E+F-Motor/ + Servolenkung ³⁾ + E+F-Motor/ + Servolenkung ³⁾		03.2122-1906.3	010761			THz 22,20 - Behälter	ATE
	1.8 2.0			01.68 01.68	08.75 08.75		13.0460-2953.2 13.0460-0422.2	602953 610422			20200 16,0 Belagsatz-Zubehör	LUC LUC
	1.8 2.0			01.69 01.69	08.75 08.75		13.0460-2954.2 13.0460-0088.2	602954 610088			20088 14,3 Belagsatz-Zubehör	LUC ATE
VOLVO 145 Kombi (68-75)												
	2.0	179797			02.75 + E+F-Motor/ + Servolenkung ³⁾		03.2122-1906.3	010761			THz 22,20 - Behälter	ATE
	2.0			08.68	02.75		13.0460-2953.2 13.0460-0422.2	602953 610422			20200 16,0 Belagsatz-Zubehör	LUC LUC
	2.0			01.69	02.75		13.0460-2954.2 13.0460-0088.2	602954 610088			20088 14,3 Belagsatz-Zubehör	LUC ATE
VOLVO 164 (68-74)												
	2.9	079022			07.74 + Bremsgerät ⁴⁾		03.2122-1906.3	010761			THz 22,20 - Behälter	ATE
	2.9			08.68	07.74		13.0460-2953.2 13.0460-0422.2	602953 610422			20200 16,0 Belagsatz-Zubehör	LUC LUC

¹⁾ - air cooled / - raffreddato ad aria / - refroidi par air / - refrigeración por aire

²⁾ + air cooled / + raffreddato ad aria / + refroidi par air / + refrigeración por aire

³⁾ + E+F-engine/ + power steering / + motore E+F/ + servosterzo / + moteur E+F/+ direct.assistée / + motor E+F/ + direcc.assistida

⁴⁾ + booster unit / + servofreno / + servo-frein / + servofreno

VOLVO 164 (68-74)	
	2.9 105782 07.74 13.0460-0088.2 610088 Belagsatz-Zubehör ATE
	2.9 132567 07.74 83.6383-0300.3 330371 2 L=300
VOLVO 240 Limousine (74-93)	
	2.0 60 08.74 07.76 - (USA) / + 4 türig ¹⁾ 03.2022-0111.3 010004 THz 22,30/15,75 - B. ATE 2.0 66 274964 08.76 - (USA) / + 2 türig ²⁾ 2.0 66 122894 08.76 - (USA) / + 2 türig ²⁾ 2.1 71 08.74 07.75 - (USA) / + 4 türig ¹⁾ 2.1 74 274964 08.75 - (USA) / + 2 türig ²⁾ 2.1 74 122894 08.75 - (USA) / + 2 türig ²⁾ 2.1 90 274894 08.74 - (USA) / + 4 türig ¹⁾ 2.1 90 122894 08.74 - (USA) / + 2 türig ²⁾
	2.0 66 122895 08.78 - (USA) / + 2 türig ²⁾ 03.2022-0112.3 010005 THz 22,30/15,75 ATE 2.0 66 274965 08.78 - (USA) / + 4 türig ¹⁾ 2.1 74 122895 08.78 - (USA) / + 2 türig ²⁾ 2.1 74 274965 08.78 - (USA) / + 4 türig ¹⁾ 2.1 90 122895 08.78 - (USA) / + 2 türig ²⁾ 2.1 90 274895 08.78 - (USA) / + 4 türig ¹⁾
	2.0 60 08.74 07.76 + (USA) 03.2022-0109.3 010003 THz 22,30/15,75 ATE 2.0 66 08.76 08.78 + (USA) 2.1 71 08.74 07.75 + (USA) 2.1 74 08.75 08.78 + (USA) 2.1 90 08.74 08.78 + (USA)
	2.0 66 09.78 07.79 03.2022-0111.3 010004 Auslaß seitlich links ³⁾ THz 22,30/15,75 - B. ATE 2.0 71 09.78 08.83 03.2022-0112.3 010005 Auslaß seitlich rechts ⁴⁾ THz 22,30/15,75 ATE 2.0 76 08.84 07.85 2.0 100 10.82 08.84 2.1 74 09.78 07.80 2.1 79 08.80 07.84 2.1 90 09.78 07.80 2.1 T 114 08.80 07.84 2.3 81 08.84 07.86 2.3 82 08.80 07.84 2.3 83 08.86 07.87 2.3 85 08.86 08.87 2.3 96 08.83 07.85 2.3 98 08.84 12.89 2.3 100 08.80 07.83 2.3 103 08.78 07.80 2.3 i Katalysator 85 08.86 08.87 2.4 D 60 08.78 07.85 2.7 104 08.79 07.80
	2.3 85 09.87 12.88 - ABS 03.2022-0112.3 010005 THz 22,30/15,75 ATE 2.3 i Katalysator 85 09.87 07.93 - ABS 2.4 D 58 09.87 08.93 - ABS
	2.3 85 09.87 12.88 - ABS 03.2022-0111.3 010004 THz 22,30/15,75 - B. ATE 2.3 i Katalysator 85 09.87 07.93 - ABS 2.4 D 58 09.87 08.93 - ABS
	2.0 60 08.74 07.76 13.0460-2953.2 602953 20200 16,0 LUC 2.0 66 08.76 07.79 13.0460-0422.2 610422 Belagsatz-Zubehör LUC 2.0 71 09.78 08.83 2.0 76 08.84 07.85 2.0 100 10.82 08.84 2.1 71 08.74 07.75 2.1 74 08.75 07.80 2.1 79 08.80 07.84 2.1 90 08.74 07.80 2.1 T 114 08.80 07.84 2.3 81 08.84 07.86 2.3 82 08.80 07.84 2.3 83 08.86 07.87 2.3 85 08.86 12.88 2.3 96 08.83 07.85 2.3 98 08.84 12.89 2.3 100 08.80 07.83 2.3 103 08.78 07.80 2.3 i Katalysator 85 08.86 07.93 2.4 D 58 08.87 08.93 2.4 D 60 08.78 07.85 2.7 104 08.79 07.80
	2.0 60 08.74 07.76 24.0114-0101.1 414101 263 14,3 12,7 2.0 66 08.76 07.79 2.0 71 08.74 08.83 2.0 76 08.84 07.85 2.0 100 10.82 08.84 2.1 71 08.74 07.75 2.1 74 08.75 07.80 2.1 79 08.80 07.84 2.1 90 08.74 07.80 2.1 T 114 08.80 07.84 2.3 81 08.84 07.86 2.3 82 08.80 07.84

1) - (USA) / + 4 door / - (USA) / + 4 porte / - (USA) / + 4 portes / - (USA) / + 4 puertas













2) - (USA) / + 2 door / - (USA) / + 2 porte / - (USA) / + 2 portes / - (USA) / + 2 puertas

3) outlet lateral left hand / scarico laterale sinistro / sortie latérale gauche / salida lateral izquierda













4) outlet lateral right hand / scarico laterale destro / sortie latérale droite / salida lateral derecha

VOLVO 240 Limousine (74-93)

	2.3	83		08.86	07.87	24.0114-0101.1	414101		263 14,3 12,7
	2.3	85		08.86	08.87				
	2.3	96		08.83	07.85				
	2.3	98		08.84	08.87				
	2.3	100		08.80	07.83				
	2.3	103		08.78	07.80				
	2.3 i Katalysator	85		08.86	08.87				
	2.4 D	60		08.78	07.85				
	2.7	104		08.79	07.80				
	2.0	60		08.74	07.76	24.0122-0127.1	422127		263 22,0 20,4 V
	2.0	66		08.76	07.79				
	2.0	71		09.78	08.83				
	2.0	76		08.84	07.85				
	2.0	100		10.82	08.84				
	2.1	71		08.74	07.75				
	2.1	74		08.75	07.80				
	2.1	79		08.80	07.84				
	2.1	90		08.74	07.80				
	2.1 T	114		08.80	07.84				
	2.3	81		08.84	07.86				
	2.3	82		08.80	07.84				
	2.3	83		08.86	07.87				
	2.3	85		08.86	12.88				
	2.3	96		08.83	07.85				
	2.3	98		08.84	12.89				
	2.3	100		08.80	07.83				
	2.3	103		08.78	07.80				
	2.3 i Katalysator	85		08.86	07.93				
	2.4 D	58		08.87	08.93				
	2.4 D	60		08.78	07.85				
	2.7	104		08.79	07.80				
	2.0	66		09.78	07.79	83.6204-0286.3	330733	4	L=285
	2.0	71		09.78	08.83				
	2.0	76		08.84	07.85				
	2.0	100		10.82	08.84				
	2.1	74		09.78	07.80				
	2.1	79		08.80	07.84				
	2.1	90		09.78	07.80				
	2.1 T	114		08.80	07.84				
	2.3	81		08.84	07.86				
	2.3	82		08.80	07.84				
	2.3	83		08.86	07.87				
	2.3	85		08.86	08.87				
	2.3	96		08.83	07.85				
	2.3	98		08.84	12.89				
	2.3	100		08.80	07.83				
	2.3	103		08.78	07.80				
	2.3 i Katalysator	85		08.86	07.93				
	2.4 D	58		08.87	08.93				
	2.4 D	60		08.78	07.85				
	2.7	104		08.79	07.80				
	2.0	60		08.74	07.76	13.2381-0039.2	210020		D=38 ATE
	2.0	66		08.76	07.79	13.2381-0040.2	210021		D=38 ATE
	2.0	71		09.78	08.83	13.0441-3812.2	250068		Dichtungssatz ATE
	2.0	76		08.84	07.85				
	2.0	100		10.82	08.84				
	2.1	71		08.74	07.75				
	2.1	74		08.75	07.80				
	2.1	79		08.80	07.84				
	2.1	90		08.74	07.80				
	2.1 T	114		08.80	07.84				
	2.3	81		08.84	07.86				
	2.3	82		08.80	07.84				
	2.3	83		08.86	07.87				
	2.3	85		08.86	12.88				
	2.3	96		08.83	07.85				
	2.3	98		08.84	12.89				
	2.3	100		08.80	07.83				
	2.3	103		08.78	07.80				
	2.3 i Katalysator	85		08.86	07.93				
	2.4 D	58		08.87	08.93				
	2.4 D	60		08.78	07.85				
	2.7	104		08.79	07.80				
	2.0	60		08.74	07.76	13.0460-2954.2	602954		20088 14,3 LUC
	2.0	66		08.76	07.79	13.0460-0088.2	610088		Belagsatz-Zubehör ATE
	2.0	71		09.78	08.83				
	2.0	76		08.84	07.85				
	2.0	100		10.82	08.84				
	2.1	71		08.74	07.75				
	2.1	74		08.75	07.80				
	2.1	79		08.80	07.84				
	2.1	90		08.74	07.80				
	2.1 T	114		08.80	07.84				
	2.3	81		08.84	07.86				
	2.3	82		08.80	07.84				
	2.3	83		08.86	07.87				
	2.3	85		08.86	12.88				

















										
VOLVO 240 Limousine (74-93)										
	2.3	96		08.83	07.85	13.0460-2954.2	602954		20088 14,3	LUC
	2.3	98		08.84	12.89	13.0460-0088.2	610088		Belagsatz-Zubehör	ATE
	2.3	100		08.80	07.83					
	2.3	103		08.78	07.80					
	2.3 i Katalysator	85		08.86	07.93					
	2.4 D	58		08.87	08.93					
	2.4 D	60		08.78	07.85					
	2.7	104		08.79	07.80					
	2.0	60		08.74	07.76	24.0110-0189.1	410189		281 9,6 8,4 +B	
	2.0	66		08.76	07.79					
	2.0	71		09.78	08.83					
	2.0	76		08.84	07.85					
	2.0	100		10.82	08.84					
	2.1	71		08.74	07.75					
	2.1	74		08.75	07.80					
	2.1	79		08.80	07.84					
	2.1	90		08.74	07.80					
	2.1 T	114		08.80	07.84					
	2.3	81		08.84	07.86					
	2.3	82		08.80	07.84					
	2.3	83		08.86	07.87					
	2.3	85		08.86	12.88					
	2.3	96		08.83	07.85					
	2.3	98		08.84	12.89					
	2.3	100		08.80	07.83					
	2.3	103		08.78	07.80					
	2.3 i Katalysator	85		08.86	07.93					
	2.4 D	58		08.87	08.93					
	2.4 D	60		08.78	07.85					
	2.7	104		08.79	07.80					
	2.3 i Katalysator	85	471317	08.86						
	2.4 D	58	471317	08.87						
	2.4 D	60		08.78	07.85					
	2.7	104		08.79	07.80					
	2.3 i Katalysator	85	471318	07.93		83.6383-0300.3	330371	2	L=300	
	2.4 D	58	471318	08.93						
	2.3 i Katalysator	85	471318	07.93		83.6124-0305.3	330723	2	L=305	
	2.4 D	58	471318	08.93						
	2.0	60		08.74	07.76	03.0137-0169.2	650169		160 x 25	
	2.0	66		08.76	07.79	03.0137-9065.2	669065		Bremsbacken-Zubehör	
	2.0	71		09.78	08.83					
	2.0	76		08.84	07.85					
	2.0	100		10.82	08.84					
	2.1	71		08.74	07.75					
	2.1	74		08.75	07.80					
	2.1	79		08.80	07.84					
	2.1	90		08.74	07.80					
	2.1 T	114		08.80	07.84					
	2.3	81		08.84	07.86					
	2.3	82		08.80	07.84					
	2.3	83		08.86	07.87					
	2.3	85		08.86	12.88					
	2.3	96		08.83	07.85					
	2.3	98		08.84	12.89					
	2.3	100		08.80	07.83					
	2.3	103		08.78	07.80					
	2.3 i Katalysator	85		08.86	07.93					
	2.4 D	58		08.87	08.93					
	2.4 D	60		08.78	07.85					
	2.7	104		08.79	07.80					
	2.0	60		08.74	07.76	24.3727-1313.2	581313	2	L=1932	
	2.0	66		08.76	07.79					
	2.0	71		09.78	08.83					
	2.0	76		08.84	07.85					
	2.0	100		10.82	08.84					
	2.1	71		08.74	07.75					
	2.1	74		08.75	07.80					
	2.1	79		08.80	07.84					
	2.1	90		08.74	07.80					
	2.1 T	114		08.80	07.84					
	2.3	81		08.84	07.86					



									
VOLVO 240 Limousine (74-93)									
	2.3	82		08.80	07.84	24.3727-1313.2	581313	2 ↓	L=1932
	2.3	83		08.86	07.87				
	2.3	85		08.86	12.88				
	2.3	96		08.83	07.85				
	2.3	98		08.84	12.89				
	2.3	100		08.80	07.83				
	2.3	103		08.78	07.80				
	2.3 i Katalysator	85		08.86	07.93				
	2.4 D	58		08.87	08.93				
	2.4 D	60		08.78	07.85				
	2.7	104		08.79	07.80				
	2.4 D	58		08.87	08.93	24.3728-1301.2	591301		L=1100
	2.4 D	60		08.78	07.85				
VOLVO 240 Kombi (74-93)									
	2.0	60		08.74	07.76	03.2022-0111.3	010004		THz 22,30/15,75 - B. ATE
	2.0	66	163834	08.76	- (USA)				
	2.1	71		08.74	07.75				
	2.1	74	163834	08.75	- (USA)				
	2.1	90	163834	08.74	- (USA)				
	2.0	66	163835	08.78	- (USA)	03.2022-0112.3	010005		THz 22,30/15,75 ATE
	2.1	74	163835	08.78	- (USA)				
	2.1	90	163835	08.78	- (USA)				
	2.0	60		08.74	07.76	03.2022-0109.3	010003		THz 22,30/15,75 ATE
	2.0	66		08.76	08.78				
	2.1	71		08.74	07.75				
	2.1	74		08.75	08.78				
	2.1	90		08.74	08.78				
	2.0	66		09.78	01.82	03.2022-0111.3	010004	Auslaß seitlich links ¹⁾	THz 22,30/15,75 - B. ATE
	2.0	71		08.80	12.84	03.2022-0112.3	010005	Auslaß seitlich rechts ²⁾	THz 22,30/15,75 ATE
	2.0	76		08.84	07.85				
	2.0	86		08.83	08.87				
	2.0	100		10.82	08.84				
	2.1	74		09.78	07.80				
	2.1	79		08.80	07.84				
	2.1	80		08.80	07.84				
	2.1	90		09.78	07.79				
	2.1 T	114		08.80	07.85				
	2.3	81		08.84	07.86				
	2.3	82		08.80	07.84				
	2.3	83		08.86	07.87				
	2.3	85		08.86	08.87				
	2.3	96		08.84	07.85				
	2.3	98		08.84	08.87				
	2.3	100		01.83	12.84				
	2.3 i Katalysator	85		08.86	08.87				
	2.4 D	60		04.79	08.87				
	2.7	104		08.79	07.80				
	2.8	95		10.81	09.82				
	2.8	114		10.80	09.82				
	2.0	86		09.87	07.93	03.2022-0112.3	010005		THz 22,30/15,75 ATE
	2.3	85		09.87	12.88				
	2.3	98		09.87	12.88				
	2.3 i Katalysator	85		09.87	07.93				
	2.3 i Katalysator	100		08.91	07.92				
	2.4 D	58		08.88	08.93				
	2.4 D	60		09.87	08.93				
	2.0	86		09.87	07.93	03.2022-0111.3	010004		THz 22,30/15,75 - B. ATE
	2.3	85		09.87	12.88				
	2.3	98		09.87	12.88				
	2.3 i Katalysator	85		09.87	07.93				
	2.3 i Katalysator	100		08.91	07.92				
	2.4 D	58		08.88	08.93				
	2.4 D	60		09.87	08.93				
	2.0	60		08.74	07.76	13.0460-2953.2	602953		20200 16,0 LUC
	2.0	66		08.76	01.82	13.0460-0422.2	610422		Belagsatz-Zubehör LUC
	2.0	71		08.80	12.84				
	2.0	76		08.84	07.85				
	2.0	86		08.83	07.93				
	2.0	100		10.82	08.84				
	2.1	71		08.74	07.75				
	2.1	74		08.75	07.80				
	2.1	79		08.80	07.84				
	2.1	80		08.80	07.84				
	2.1	90		08.74	07.79				
	2.1 T	114		08.80	07.85				
	2.3	81		08.84	07.86				
	2.3	82		08.80	07.84				
	2.3	83		08.86	07.87				
	2.3	85		08.86	12.88				
	2.3	96		08.84	07.85				
	2.3	98		08.84	12.88				
	2.3	100		01.83	12.84				
	2.3 i Katalysator	85		08.86	07.93				
	2.3 i Katalysator	100		08.91	07.92				

¹⁾ outlet lateral left hand / scarico laterale sinistro / sortie latérale gauche / salida lateral izquierda

²⁾ outlet lateral right hand / scarico laterale destro / sortie latérale droite / salida lateral derecha

VOLVO 240 Kombi (74-93)										
										
	2.4 D	58		08.88	08.93	13.0460-2953.2	602953		20200 16,0	LUC
	2.4 D	60		04.79	08.93	13.0460-0422.2	610422		Belagsatz-Zubehör	LUC
	2.7	104		08.79	07.80					
	2.8	95		10.81	09.82					
	2.8	114		10.80	09.82					
	2.0	60		08.74	07.76	24.0114-0101.1	414101		263 14,3 12,7	
	2.0	66		08.76	01.82					
	2.0	71		08.80	12.84					
	2.0	76		08.84	07.85					
	2.0	86		08.83	07.93					
	2.0	100		10.82	08.84					
	2.1	71		08.74	07.75					
	2.1	74		08.75	07.80					
	2.1	79		08.80	07.84					
	2.1	80		08.80	07.84					
	2.1	90		08.74	07.79					
	2.1 T	114		08.80	07.85					
	2.3	81		08.84	07.86					
	2.3	82		08.80	07.84					
	2.3	83		08.86	07.87					
	2.3	85		08.86	12.88					
	2.3	96		08.84	07.85					
	2.3	98		08.84	12.88					
	2.3	100		01.83	12.84					
	2.3 i Katalysator	85		08.86	07.93					
	2.3 i Katalysator	100		08.91	07.92					
	2.4 D	58		08.88	08.93					
	2.4 D	60		04.79	08.93					
	2.7	104		08.79	07.80					
	2.8	95		10.81	09.82					
	2.8	114		10.80	09.82					
	2.0	60		08.74	07.76	24.0122-0127.1	422127		263 22,0 20,4 V	
	2.0	66		08.76	01.82					
	2.0	71		08.80	12.84					
	2.0	76		08.84	07.85					
	2.0	86		08.83	07.93					
	2.0	100		10.82	08.84					
	2.1	71		08.74	07.75					
	2.1	74		08.75	07.80					
	2.1	79		08.80	07.84					
	2.1	80		08.80	07.84					
	2.1	90		08.74	07.79					
	2.1 T	114		08.80	07.85					
	2.3	81		08.84	07.86					
	2.3	82		08.80	07.84					
	2.3	83		08.86	07.87					
	2.3	85		08.86	12.88					
	2.3	96		08.84	07.85					
	2.3	98		08.84	12.88					
	2.3	100		01.83	12.84					
	2.3 i Katalysator	85		08.86	07.93					
	2.3 i Katalysator	100		08.91	07.92					
	2.4 D	58		08.88	08.93					
	2.4 D	60		04.79	08.93					
	2.7	104		08.79	07.80					
	2.8	95		10.81	09.82					
	2.8	114		10.80	09.82					
	2.0	66		09.78	01.82	83.6204-0286.3	330733	4	L=285	
	2.0	71		08.80	12.84					
	2.0	76		08.84	07.85					
	2.0	86		08.83	07.93					
	2.0	100		10.82	08.84					
	2.1	74		09.78	07.80					
	2.1	79		08.80	07.84					
	2.1	80		08.80	07.84					
	2.1	90		09.78	07.79					
	2.1 T	114		08.80	07.85					
	2.3	81		08.84	07.86					
	2.3	82		08.80	07.84					
	2.3	83		08.86	07.87					
	2.3	85		08.86	12.88					
	2.3	96		08.84	07.85					
	2.3	98		08.84	12.88					
	2.3	100		01.83	12.84					
	2.3 i Katalysator	85		08.86	07.93					
	2.3 i Katalysator	100		08.91	07.92					
	2.4 D	58		08.88	08.93					
	2.4 D	60		04.79	08.93					
	2.7	104		08.79	07.80					
	2.8	95		10.81	09.82					
	2.8	114		10.80	09.82					
	2.0	60		08.74	07.76	13.2381-0039.2	210020		D=38	ATE
	2.0	66		08.76	01.82	13.2381-0040.2	210021		D=38	ATE
	2.0	71		08.80	12.84	13.0441-3812.2	250068		Dichtungssatz	ATE
	2.0	76		08.84	07.85					
	2.0	86		08.83	07.93					
	2.0	100		10.82	08.84					
										

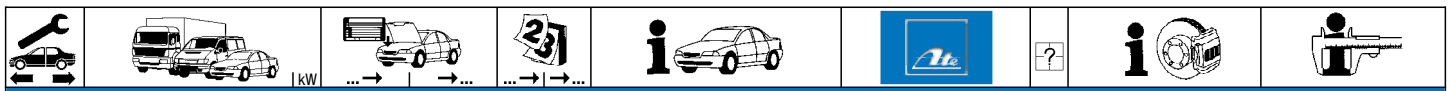

VOLVO 240 Kombi (74-93)

	2.1 2.1 2.1 2.1 2.1 2.1 T 2.3 2.3 2.3 2.3 2.3 2.3 2.3 2.3 2.3 i Katalysator 2.3 i Katalysator 2.4 D 2.4 D 2.7 2.8 2.8	71 74 79 80 90 114 81 82 83 85 96 98 100 85 100 58 60 104 95 114		08.74 07.75 08.75 07.80 08.80 07.84 08.80 07.84 08.74 07.79 08.80 07.85 08.84 07.86 08.80 07.84 08.86 07.87 08.86 12.88 08.84 07.85 08.84 12.88 01.83 12.84 08.86 07.93 08.91 07.92 08.88 08.93 04.79 08.93 08.79 07.80 10.81 09.82 10.80 09.82	13.2381-0039.2 210020 13.2381-0040.2 210021 13.0441-3812.2 250068		D=38 D=38 Dichtungssatz	ATE ATE ATE
	2.0 2.0 2.0 2.0 2.0 2.1 2.1 2.1 2.1 2.1 2.1 T 2.3 2.3 2.3 2.3 2.3 2.3 2.3 2.3 2.3 i Katalysator 2.3 i Katalysator 2.4 D 2.4 D 2.7 2.8 2.8	60 66 71 76 86 100 71 74 79 80 90 114 81 82 83 85 96 98 100 85 100 58 60 104 95 114		08.74 07.76 08.76 01.82 08.80 12.84 08.84 07.85 08.83 07.93 10.82 08.84 08.74 07.75 08.75 07.80 08.80 07.84 08.80 07.84 08.74 07.79 08.80 07.85 08.84 07.86 08.80 07.84 08.86 07.87 08.86 12.88 08.84 07.85 08.84 12.88 01.83 12.84 08.86 07.93 08.91 07.92 08.88 08.93 04.79 08.93 08.79 07.80 10.81 09.82 10.80 09.82	13.0460-2954.2 602954 13.0460-0088.2 610088		20088 14.3 Belagsatz-Zubehör	LUC ATE
	2.0 2.0 2.0 2.0 2.0 2.1 2.1 2.1 2.1 2.1 2.1 T 2.3 2.3 2.3 2.3 2.3 2.3 2.3 2.3 2.3 i Katalysator 2.3 i Katalysator 2.4 D 2.4 D 2.7 2.8 2.8	60 66 71 76 86 100 71 74 79 80 90 114 81 82 83 85 96 98 100 85 100 58 60 104 95 114		08.74 07.76 08.76 01.82 08.80 12.84 08.84 07.85 08.83 07.93 10.82 08.84 08.74 07.75 08.75 07.80 08.80 07.84 08.80 07.84 08.74 07.79 08.80 07.85 08.84 07.86 08.80 07.84 08.86 07.87 08.86 12.88 08.84 07.85 08.84 12.88 01.83 12.84 08.86 07.93 08.91 07.92 08.88 08.93 04.79 08.93 08.79 07.80 10.81 09.82 10.80 09.82	24.0110-0189.1 410189		281 9,6 8,4 +B	
	2.0 2.0 2.0 2.0 2.0 2.1 2.1 2.1 2.1 2.1 2.1 T 2.3 2.3 2.3 2.3 2.3 2.3 2.3 2.3 2.3 i Katalysator 2.3 i Katalysator 2.4 D 2.4 D 2.7 2.8 2.8	60 66 71 76 86 100 71 74 79 80 90 114 81 82 83 85 96 98 100 85 100 58 60 104 95 114	928357	08.74 07.76 08.76 01.82 08.80 12.84 08.84 07.85 08.83 07.85 10.82 08.84 08.74 07.75 08.75 07.80 08.80 07.84 08.80 07.84 08.74 07.79 08.80 07.85 08.84 07.86 08.80 07.84 08.86 07.87 08.86 12.88 08.84 07.85 08.84 12.88 01.83 12.84 08.86 07.93 08.91 07.92 08.88 08.93 04.79 08.93 08.79 07.80 10.81 09.82 10.80 09.82	83.6383-0300.3 330371	2	L=300	



VOLVO 240 Kombi (74-93)																
	2.3	85		08.86	12.88	83.6383-0300.3	330371	2		L=300						
	2.3	96		08.84	07.85											
	2.3	98		08.84	12.88											
	2.3	100		01.83	12.84											
	2.3 i Katalysator	85	928357	08.86												
	2.3 i Katalysator	100		08.91	07.92											
	2.4 D	58	928357	08.88												
	2.4 D	60	928357	04.79												
	2.7	104		08.79	07.80											
	2.8	95		10.81	09.82											
2.8	114		10.80	09.82												
	2.0	86	928358		07.93	83.6124-0305.3	330723	2		L=305						
	2.3 i Katalysator	85	928358		07.93											
	2.4 D	58	928358		08.93											
	2.4 D	60	928358		08.93											
	2.0	60		08.74	07.76	03.0137-0169.2	650169			160 x 25 Bremsbacken-Zubehör						
	2.0	66		08.76	01.82											
	2.0	71		08.80	12.84											
	2.0	76		08.84	07.85											
	2.0	86		08.83	07.93											
	2.0	100		10.82	08.84											
	2.1	71		08.74	07.75											
	2.1	74		08.75	07.80											
	2.1	79		08.80	07.84											
	2.1	80		08.80	07.84											
	2.1	90		08.74	07.79											
	2.1 T	114		08.80	07.85											
	2.3	81		08.84	07.86											
	2.3	82		08.80	07.84											
	2.3	83		08.86	07.87											
	2.3	85		08.86	12.88											
	2.3	96		08.84	07.85											
	2.3	98		08.84	12.88											
	2.3	100		01.83	12.84											
	2.3 i Katalysator	85		08.86	07.93											
	2.3 i Katalysator	100		08.91	07.92											
	2.4 D	58		08.88	08.93											
	2.4 D	60		04.79	08.93											
	2.7	104		08.79	07.80											
	2.8	95		10.81	09.82											
	2.8	114		10.80	09.82											
		2.0	66		09.78						01.82	24.3727-1313.2	581313	2		L=1932
		2.0	71		08.80						12.84					
2.0		76		08.84	07.85											
2.0		86		08.83	07.93											
2.0		100		10.82	08.84											
2.1		74		09.78	07.80											
2.1		79		08.80	07.84											
2.1		80		08.80	07.84											
2.1		90		09.78	07.79											
2.1 T		114		08.80	07.85											
2.3		81		08.84	07.86											
2.3		82		08.80	07.84											
2.3		83		08.86	07.87											
2.3		85		08.86	12.88											
2.3		96		08.84	07.85											
2.3		98		08.84	12.88											
2.3		100		01.83	12.84											
2.3 i Katalysator		85		08.86	07.93											
2.3 i Katalysator		100		08.91	07.92											
2.4 D		58		08.88	08.93											
2.4 D		60		04.79	08.93											
2.7		104		08.79	07.80											
2.8		95		10.81	09.82											
2.8		114		10.80	09.82											
		2.4 D	58		08.88	08.93	24.3728-1301.2	591301			L=1100					
		2.4 D	60		04.79	08.93										
VOLVO 260 Limousine (74-82)																
		2.7	92	046514	08.76		03.2022-0111.3	010004			THz 22,30/15,75 - B. ATE					
	2.7	103	046514	08.74												
	2.7	92	046515	08.78												
	2.7	103	046515	08.78												
	2.7	92		08.76												
	2.7	92		08.76												
	2.7	103		08.74												
	2.7	103		08.74												
	2.7	92		09.78												
	2.7	103		09.78												
	2.7	109		08.78												
	2.8	95		08.80												
	2.8	114		08.80												

1) - (USA) / + 4 door / - (USA) / + 4 porte / - (USA) / + 4 portes / - (USA) / + 4 puertas
2) + (USA) / + 2 door / + (USA) / + 2 porte / + (USA) / + 2 portes / + (USA) / + 2 puertas
3) + (USA) / + 4 door / + (USA) / + 4 porte / + (USA) / + 4 portes / + (USA) / + 4 puertas
4) outlet lateral left hand / scarico laterale sinistro / sortie latérale gauche / salida lateral izquierda
5) outlet lateral right hand / scarico laterale destro / sortie latérale droite / salida lateral derecha

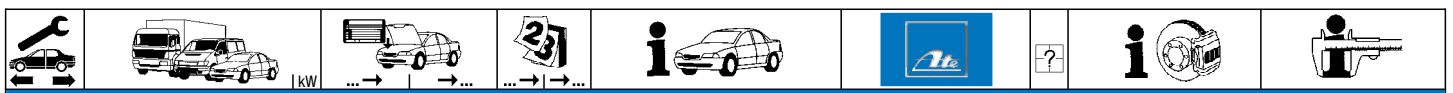

VOLVO 260 Limousine (74-82)

	2.7	92		08.76	07.82		13.0460-2953.2	602953			20200 16,0	LUC
	2.7	103		01.75	07.80		13.0460-0422.2	610422			Belagsatz-Zubehör	LUC
	2.7	109		08.78	07.82							
	2.8	95		08.80	07.82							
	2.8	114		08.80	07.82							
	2.7	92		08.76	08.78		24.0114-0101.1	414101			263 14,3 12,7	
	2.7	103		08.74	08.78							
	2.7	92		09.78	07.82		24.0122-0127.1	422127			263 22,0 20,4 V	
	2.7	103		09.78	07.80							
	2.7	109		08.78	07.82							
	2.8	95		08.80	07.82							
	2.8	114		08.80	07.82							
	2.7	92		09.78	07.82		83.6204-0286.3	330733	4		L=285	
	2.7	103		09.78	07.80							
	2.7	109		08.78	07.82							
	2.8	95		08.80	07.82							
	2.8	114		08.80	07.82							
	2.7	92		08.76	07.82		13.2381-0039.2	210020			D=38	ATE
	2.7	103		08.74	07.80		13.2381-0040.2	210021			D=38	ATE
	2.7	109		08.78	07.82		13.0441-3812.2	250068			Dichtungssatz	ATE
	2.8	95		08.80	07.82							
	2.8	114		08.80	07.82							
	2.7	92		08.76	07.82		13.0460-2954.2	602954			20088 14,3	LUC
	2.7	103		08.74	07.80		13.0460-0088.2	610088			Belagsatz-Zubehör	ATE
	2.7	109		08.78	07.82							
	2.8	95		08.80	07.82							
	2.8	114		08.80	07.82							
	2.7	92		08.76	07.82		24.0110-0189.1	410189			281 9,6 8,4 +B	
	2.7	103		08.74	07.80							
	2.7	109		08.78	07.82							
	2.8	95		08.80	07.82							
	2.8	114		08.80	07.82							
	2.7	92		08.76	07.82		83.6383-0300.3	330371	2		L=300	
	2.7	103		08.74	07.80							
	2.7	109		08.78	07.82							
	2.8	95		08.80	07.82							
	2.8	114		08.80	07.82							
	2.7	92		08.76	07.82		03.0137-0169.2	650169			160 x 25	
	2.7	103		08.74	07.80		03.0137-9065.2	669065			Bremsbacken-Zubehör	
	2.7	109		08.78	07.82							
	2.8	95		08.80	07.82							
	2.8	114		08.80	07.82							
	2.7	92		08.76	07.82		24.3727-1313.2	581313	2		L=1932	
	2.7	103		08.74	07.80							
	2.7	109		08.78	07.82							
	2.8	95		08.80	07.82							
	2.8	114		08.80	07.82							

VOLVO 260 Kombi (75-82)

	2.7	92		08.75	07.77	- (USA)	03.2022-0111.3	010004			THz 22,30/15,75 - B.	ATE
	2.7	103	010919	07.75		- (USA)						
	2.7	103	010920		08.78	- (USA)	03.2022-0112.3	010005			THz 22,30/15,75	ATE
	2.7	103		07.75	08.78	+ (USA)	03.2022-0109.3	010003			THz 22,30/15,75	ATE
	2.7	103		09.78	07.82		03.2022-0111.3	010004		Auslaß seitlich links ¹⁾	THz 22,30/15,75 - B.	ATE
	2.7	109		10.78	07.82		03.2022-0112.3	010005		Auslaß seitlich rechts ²⁾	THz 22,30/15,75	ATE
	2.8	114		08.80	07.82							
	2.7	92		08.75	07.77		13.0460-2953.2	602953			20200 16,0	LUC
	2.7	103		07.75	07.82		13.0460-0422.2	610422			Belagsatz-Zubehör	LUC
	2.7	109		10.78	07.82							
	2.8	114		08.80	07.82							
	2.7	92		08.75	07.77		24.0114-0101.1	414101			263 14,3 12,7	
	2.7	103		07.75	08.78							
	2.7	103		09.78	07.82		24.0122-0127.1	422127			263 22,0 20,4 V	
	2.7	109		10.78	07.82							
	2.8	114		08.80	07.82							
	2.7	103		09.78	07.82		83.6204-0286.3	330733	4		L=285	
	2.7	109		10.78	07.82							
	2.8	114		08.80	07.82							
	2.7	92		08.75	07.77		13.2381-0039.2	210020			D=38	ATE
	2.7	103		07.75	07.82		13.2381-0040.2	210021			D=38	ATE
	2.7	109		10.78	07.82		13.0441-3812.2	250068			Dichtungssatz	ATE
	2.8	114		08.80	07.82							
	2.7	92		08.75	07.77		13.0460-2954.2	602954			20088 14,3	LUC
	2.7	103		07.75	07.82		13.0460-0088.2	610088			Belagsatz-Zubehör	ATE
	2.7	109		10.78	07.82							
	2.8	114		08.80	07.82							
	2.7	92		08.75	07.77		24.0110-0189.1	410189			281 9,6 8,4 +B	
	2.7	103		07.75	07.82							
	2.7	109		10.78	07.82							
	2.8	114		08.80	07.82							























¹⁾ outlet lateral left hand / scarico laterale sinistro / sortie latérale gauche / salida lateral izquierda























²⁾ outlet lateral right hand / scarico laterale destro / sortie latérale droite / salida lateral derecha

VOLVO 260 Kombi (75-82)																	
	2.7	92			08.75	07.77				83.6383-0300.3	330371	2					L=300
	2.7	103			07.75	07.82											
	2.7	109			10.78	07.82											
	2.8	114			08.80	07.82											
	2.7	92			08.75	07.77				03.0137-0169.2	650169						160 x 25
	2.7	103			07.75	07.82				03.0137-9065.2	669065						Bremsbacken-Zubehör
	2.7	109			10.78	07.82											
	2.8	114			08.80	07.82											
	2.7	103			09.78	07.82				24.3727-1313.2	581313	2	↓				L=1932
	2.7	109			10.78	07.82											
	2.8	114			08.80	07.82											
VOLVO 260 Coupe (77-78)																	
	2.7	103			08.77	07.78				03.2022-0109.3	010003						Thz 22,30/15,75
	2.7	103			08.77	07.78											
	2.7	103			08.77	07.78				13.0460-2953.2	602953						20200 16,0
	2.7	103			08.77	07.78				13.0460-0422.2	610422						Belagsatz-Zubehör
	2.7	103			08.77	07.78				24.0114-0101.1	414101						263 14,3 12,7
	2.7	103			08.77	07.78				13.2381-0039.2	210020						D=38
	2.7	103			08.77	07.78				13.2381-0040.2	210021						D=38
	2.7	103			08.77	07.78				13.0441-3812.2	250068						Dichtungssatz
	2.7	103			08.77	07.78				13.0460-2954.2	602954						20088 14,3
	2.7	103			08.77	07.78				13.0460-0088.2	610088						Belagsatz-Zubehör
	2.7	103			08.77	07.78				24.0110-0189.1	410189						281 9,6 8,4 +B
	2.7	103			08.77	07.78				83.6383-0300.3	330371	2					L=300
	2.7	103			08.77	07.78				03.0137-0169.2	650169						160 x 25
	2.7	103			08.77	07.78				03.0137-9065.2	669065						Bremsbacken-Zubehör
	2.7	103			08.77	07.78				24.3727-1313.2	581313	2	↓				L=1932
VOLVO 340 (76-90)																	
	1.4	907152			08.90					24.2120-0912.3	010366						Thz 20,64
	1.6 D	907152			08.90												
	1.7				07.85	08.90											
	1.4				09.79	08.90				24.0113-0172.1	413172						239 12,8 11,4
	1.6 D				01.84	08.90											
	1.7				07.85	08.90											
	1.4		451742		02.76					83.6104-0241.3	330731	2					L=240
	1.4	451743			08.79												
	1.6 D	451743			01.84	08.90				24.5113-0280.3	330393	2					L=280
	1.7				07.85	08.90											
	1.4				02.76	08.90				83.6204-0240.3	330718	2					L=240
	1.6 D				01.84	08.90											
	1.7				07.85	08.90											
	1.4				02.76	08.90				24.3219-0903.3	020184						Rz 19,05
	1.6 D				01.84	08.90											
	1.7				07.85	08.90											
	1.4				02.76	08.90				03.0137-9173.2	669173						Bremsbacken-Zubehör
	1.6 D				01.84	08.90											
	1.7				07.85	08.90											
	1.4		120999		02.76					03.6058-0501.3	320074						BR 25/5 (4)
	1.4	121000			08.90					03.6055-0303.3	320064						ATE
	1.4		120999		02.76												
	1.6 D		120999		01.84					03.6053-0100.3	320053						BR 30/3 (4)
	1.7		120999		07.85												ATE
VOLVO 345 (80-89)																	
	2.0	903121			08.84					24.2120-0912.3	010366						Thz 20,64
	2.0				09.84	07.89											
	2.0				08.80	07.89				24.0113-0172.1	413172						239 12,8 11,4
	2.0				08.80	07.89				24.5113-0280.3	330393	2					L=280
	2.0				08.80	07.89				83.6204-0240.3	330718	2					L=240

1) + autom.transmission / + scatola cambio automatico / + transmission automatique / + cambio automático

2) + manual transmission / + scatola cambio velocità / + transmission mécanique / + cambio de velocidad

									
VOLVO 345 (80-89)									
	2.0			08.80	07.89	03.0137-0271.2 03.0137-9027.2	650271 669027	229 x 42 HEB Bremsbacken-Zubehör	LUC LUC
	2.0		120999	08.80		03.6053-0100.3	320053	BR 30/3 (4)	ATE
VOLVO 360 (82-90)									
	2.0	903121		08.84		24.2120-0912.3	010366	Thz 20,64	
	2.0			09.84	07.90				
	2.0			08.82	07.90	24.0113-0172.1	413172	239 12,8 11,4	
	2.0			08.82	07.90	24.5113-0280.3	330393	L=280	
	2.0			08.82	07.90	83.6204-0240.3	330718	L=240	
	2.0			08.82	07.90	03.0137-0271.2 03.0137-9027.2	650271 669027	229 x 42 HEB Bremsbacken-Zubehör	LUC LUC
	2.0		120999	08.82		03.6053-0100.3	320053	BR 30/3 (4)	ATE
VOLVO 440 (88-96)									
	1.6	61		09.92	12.96 + ABS	10.6120-0287.3	010334	Thz 20,64	ATE
	1.7	64		09.92	12.96 + ABS				
	1.7	75		09.92	12.96 + ABS				
	1.7	78		09.92	12.96 + ABS				
	1.7 T	88		09.92	07.96 + ABS				
	1.7 T	90		09.92	12.96 + ABS				
	1.8	66		09.92	12.96 + ABS				
	1.9 TD	66		07.94	12.96 + ABS				
	2.0	80		08.93	07.96 + ABS				
	2.0	81		09.92	07.95 + ABS				
	1.6	61 EKC 006387		12.96		24.0101-3601.2	260044	Bremssattel-Zubehör	LUC
	1.7	64 EKC 006387		12.96					
	1.7	70 EKC 006387		07.89					
	1.7	75 EKC 006387		12.96					
	1.7	78 EKC 006387		12.96					
	1.8	66		08.91	12.96				
	1.9 TD	66		07.94	12.96				
	2.0	80 EKC 006387		07.96					
	1.7 T	88		08.88	07.96	11.9541-9806.2	220504	D=54, - Halter	ATE
	1.7 T	90		01.91	12.96	11.8116-0073.1	390498	Haltefeder	ATE
	2.0	80		08.93	07.96	11.8171-0008.1	990049	Führungsbolzen	ATE
	2.0	81		08.92	07.95	11.0101-5407.2	260011	Hülsensatz	ATE
	1.6	61	EKC 006386	09.88		13.0460-2846.2	602846	21010 15,8 /S	LUC
	1.7	64	EKC 006386	09.88					
	1.7	70	EKC 006386	08.88					
	1.7	75	EKC 006386	08.89					
	1.7	78	EKC 006386	09.88					
	1.6	61 EKC 006387		12.96		13.0460-2812.2	602812	21217 18,0 /S	LUC
	1.7	64 EKC 006387		12.96					
	1.7	70 EKC 006387		07.89					
	1.7	75 EKC 006387		12.96					
	1.7	78 EKC 006387		12.96					
	1.8	66		08.91	12.96				
	1.9 TD	66		07.94	12.96				
	2.0	80 EKC 006387		07.96					
	1.7 T	88		08.88	07.96	13.0460-7146.2	607146	20147 17,0 +	ATE
	1.7 T	90		01.91	12.96				
	2.0	80		08.93	07.96				
	2.0	81		08.92	07.95				
	1.6	61		09.88	12.96	24.0112-0135.1	412135	260 12,0 10,8	
	1.7	64		09.88	12.96				
	1.7	70		08.88	07.89				
	1.7	75		08.89	12.96				
	1.7	78		09.88	12.96				
	1.8	66		08.91	12.96				
	1.9 TD	66		07.94	12.96				
	2.0	80 EKC 006387		07.96					
	1.7 T	88		08.88	07.96	24.0122-0164.1	422164	256 22,0 20,0 V	
	1.7 T	90		01.91	12.96				
	2.0	80		08.93	07.96				
	2.0	81		08.92	07.95				
	1.6	61		09.88	12.96	24.5170-0465.3	331331	L=465	
	1.7	64		09.88	12.96				
	1.7	70		08.88	07.89				
	1.7	75		08.89	12.96				
	1.7	78		09.88	12.96				
	1.7 T	88		08.88	07.96				

									
VOLVO 440 (88-96)									
	1.7 T 1.8 1.9 TD 2.0 2.0	90 66 66 80 81		01.91 12.96 08.91 12.96 07.94 12.96 08.93 07.96 08.92 07.95		24.5170-0465.3	331331	2	L=465
	1.6 1.7 1.7 1.7 T 1.7 T 1.8 1.9 TD 2.0	61 75 78 88 90 66 66 81		09.88 12.96 08.89 12.96 09.88 12.96 08.88 07.96 01.91 12.96 08.91 12.96 07.94 12.96 08.92 07.95		11.0441-3303.2 11.0101-5402.2 11.8171-0008.1 11.8116-0047.1	250005 260009 990049 390494	2	Dichtungssatz Hülzensatz Führungsbolzen Haltefeder ATE ATE ATE ATE
	1.6 1.7 1.7 1.7 T 1.7 T 1.8 1.9 TD 2.0	61 75 78 88 90 66 66 81		09.88 12.96 08.89 12.96 09.88 12.96 08.88 07.96 01.91 12.96 08.91 12.96 07.94 12.96 08.92 07.95		13.0460-3306.2	603306		21089 15,0 + ATE
	1.6 1.7 1.7 1.7 T 1.7 T 1.8 1.9 TD 2.0	61 75 78 88 90 66 66 81		09.88 12.96 08.89 12.96 09.88 12.96 08.88 07.96 01.91 12.96 08.91 12.96 07.94 12.96 08.92 07.95		24.0109-0125.1	409125		228 9,0 8,0
	1.6 1.7 1.7 1.7 1.7 1.7 1.8 1.9 TD 2.0	61 64 70 75 78 66 66 80		09.88 12.96 - ABS 09.88 12.96 - ABS 08.88 07.89 - ABS 08.89 12.96 - ABS/ + HA-Trommelbremse 1) 09.88 12.96 - ABS/ + HA-Trommelbremse 1) 08.91 12.96 - ABS/ + HA-Trommelbremse 1) 07.94 12.96 - ABS/ + HA-Trommelbremse 1) 08.93 07.96 - ABS		83.6104-0336.3	330451	2	L=335
	1.7 1.7 1.7 1.7 1.7 1.7 1.7 T 1.7 T 1.7 T 1.7 T 1.8 1.8 1.9 TD 2.0	64 70 75 75 78 78 88 88 90 90 66 66 66 81		09.88 08.92 + ABS 08.88 07.89 + ABS 08.89 12.96 - ABS/ + HA-Scheibenbremse 2) 08.89 08.92 + ABS 09.88 12.96 - ABS/ + HA-Scheibenbremse 2) 09.88 08.92 + ABS 08.88 07.96 - ABS 08.88 08.92 + ABS 01.91 12.96 - ABS 01.91 08.92 + ABS 08.91 12.96 - ABS/ + HA-Scheibenbremse 2) 08.91 08.92 + ABS 07.94 12.96 - ABS/ + HA-Scheibenbremse 2) 08.92 07.95 - ABS		83.6104-0295.3	330244	2	L=295
	1.6 1.7 1.7 1.7 1.7 T 1.7 T 1.8 1.9 TD 2.0 2.0	61 64 75 78 88 90 66 66 80 81		09.92 12.96 + ABS 09.92 12.96 + ABS 09.92 12.96 + ABS 09.92 12.96 + ABS 09.92 07.96 + ABS 09.92 12.96 + ABS 09.92 12.96 + ABS 07.94 12.96 + ABS 08.93 07.96 + ABS 09.92 07.95 + ABS		83.6124-0285.3	330722	2	L=285
	1.6 1.7 1.7 1.7 1.7 1.7 T 1.7 T 1.8 1.9 TD 2.0 2.0	61 64 70 75 78 88 90 66 66 80 81		09.88 12.96 09.88 12.96 08.88 07.89 08.89 12.96 09.88 12.96 08.88 07.96 01.91 12.96 08.91 12.96 07.94 12.96 08.93 07.96 08.92 07.95		24.0721-1915.3 24.0721-1916.3	360149 360150	 	Radsensor L=847 Radsensor L=847
	1.6 1.7 1.7 1.7 1.7 1.8 1.9 TD 2.0	61 64 70 75 78 66 66 80		09.88 12.96 09.88 12.96 08.88 07.89 08.89 12.96 09.88 12.96 08.91 12.96 07.94 12.96 08.93 07.96		24.3220-1113.3	020224		Rz 20,64
	1.6 1.7 1.7 1.7 1.7 1.8	61 64 70 75 78 66		09.88 12.96 09.88 12.96 08.88 07.89 08.89 12.96 09.88 12.96 08.91 12.96		03.0137-0258.2 03.0137-9158.2	650258 669158		203 x 38 HEB Bremsbacken-Zubehör LUC LUC

1) - ABS/ + RA drum brake / - ABS/ + P freno a tamburo / - ABS/ + fr. à tambour essieu AR / - ABS/ + ET tambores de freno

2) - ABS/ + RA disc brake / - ABS/ + P disco freno / - ABS/ + fr. à disque essieu AR / - ABS/ + ET disco de freno

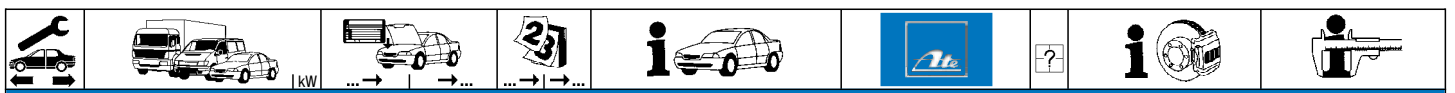

VOLVO 440 (88-96)										
	1.9 TD 2.0	66 80		07.94 08.93	12.96 07.96	03.0137-0258.2 03.0137-9158.2	650258 669158		203 x 38 HEB Bremsbacken-Zubehör	LUC LUC
	1.6 1.7 1.7 1.7 1.7 1.8 1.9 TD 2.0	61 64 70 75 78 66 66 80		09.88 09.88 08.88 08.89 09.88 08.91 07.94 08.93	12.96 12.96 07.89 12.96 12.96 12.96 12.96 07.96	24.0220-3015.1	480091		203/204,5 x 46,5	
	1.6 1.7 1.7 1.7 1.7	61 64 70 75 78	ELC 165500	09.88 08.88 08.88 08.89 09.88	12.96 12.96 07.89 + HA-Trommelbremse 1) + HA-Trommelbremse 1)	24.3727-1307.2	581307	2 ↓	L=1365	
	1.7 1.8 1.9 TD 2.0	75 66 66 80	EMC 165501	08.91 07.94 08.93	12.96 12.96 12.96 + HA-Trommelbremse 1) + HA-Trommelbremse 1) + HA-Trommelbremse 1) + HA-Trommelbremse 1)	24.3727-1310.2	581310	2 ↓	L=1338	
	1.7 1.7 1.7 T 1.7 T 1.8 1.9 TD 2.0	75 78 88 90 66 66 81	EMC 165501 EMC 165501 EMC 165501 EMC 165501	08.91 07.94 08.92	12.96 12.96 07.96 12.96 12.96 12.96 + HA-Scheibenbremse 2) + HA-Scheibenbremse 2) + HA-Scheibenbremse 2) + HA-Scheibenbremse 2) + HA-Scheibenbremse 2) + HA-Scheibenbremse 2)	24.3727-1309.2	581309	2 ↓	L=1428	
	1.6 1.7 1.7 1.7 1.7 1.7 T 1.7 T 1.8	61 64 70 75 78 88 90 66		09.88 09.88 08.88 08.89 09.88 08.88 01.91 08.91	08.92 08.92 07.89 08.92 08.92 08.92 08.92 08.92 - ABS - ABS - ABS - ABS - ABS - ABS - ABS	03.0101-0014.2	320004		BRES 3/25	ATE
	1.6 1.7 1.7 T 1.7 T 1.8 2.0 2.0	61 75 88 90 66 80 81	EMC 185081 EMC 185081	09.88 01.91 08.91 08.93 08.92	12.96 12.96 07.96 12.96 12.96 07.96 07.95	24.3728-1303.2	591303		L=782	























VOLVO 460 (88-96)										
	1.6 1.7 1.7 1.7 T 1.7 T 1.8 1.9 TD 2.0 2.0	61 64 66 88 90 66 66 80 81		09.92 09.92 09.92 09.92 09.92 07.94 08.93 09.92	07.96 07.96 07.96 07.96 07.96 07.96 07.96 07.95 + ABS + ABS + ABS + ABS + ABS + ABS + ABS + ABS	10.6120-0287.3	010334		1Hz 20,64	ATE
	1.6 1.7 1.7 1.7 1.7 1.8 1.9 TD 2.0 2.0	61 64 66 75 80 66 66 80 81	EKC 006387 EKC 006387 EKC 006387 EKC 006387	07.92 07.92 07.92 07.92 08.91 07.94 08.92	07.96 07.96 07.96 07.92 07.96 07.96 07.96 07.95	24.0101-3601.2	260044		Bremssattel-Zubehör	LUC
	1.7 T 1.7 T 2.0 2.0	88 90 80 81		08.89 01.91 08.93 08.92	07.96 07.96 07.96 07.95	11.9541-9806.2 11.8116-0073.1 11.8171-0008.1 11.0101-5407.2	220504 390498 990049 260011	2	D=54, - Halter Haltefeder Führungsbolzen Hülzensatz	ATE ATE ATE ATE
	1.7 1.7 1.7 1.7	64 66 75 80	EKC 006386 EKC 006386 EKC 006386 EKC 006386	09.88 09.90 08.89 08.89		13.0460-2846.2	602846		21010 15,8 /S	LUC
	1.6 1.7 1.7 1.7 1.7 1.7 1.8 1.9 TD 2.0 2.0	61 64 66 75 80 66 66 80 81	EKC 006387 EKC 006387 EKC 006387 EKC 006387	07.92 07.92 07.92 07.92 08.91 07.94 08.92	07.96 07.96 07.96 07.92 07.96 07.96 07.96 07.95	13.0460-2812.2	602812		21217 18,0 /S	LUC
	1.7 T 1.7 T 2.0 2.0	88 90 80 81		08.89 01.91 08.93 08.92	07.96 07.96 07.96 07.95	13.0460-7146.2	607146		20147 17,0 +	ATE

1) + RA drum brake / + P freno a tamburo / + frein à tambour essieu AR / + ET-tambores de freno
 2) + RA disc brake / + P disco freno / + frein à disque essieu AR / + ET-disco de freno



VOLVO 460 (88-96)		kW			
	1.6	61		07.92	07.96	24.0112-0135.1	412135		nur für Lucas-Sättel ¹⁾	260 12,0 10,8								
	1.7	64		09.88	07.96													
	1.7	66		09.90	07.96													
	1.7	75		08.89	07.92													
	1.7	80		08.89	07.92													
	1.8	66		08.91	07.96													
	1.9 TD	66		07.94	07.96													
	2.0	80	EKC 006387		07.96													
	2.0	81		08.92	07.95													
	1.7 T	88		08.89	07.96	24.0122-0164.1	422164		nur für ATE-Sättel ²⁾	256 22,0 20,0 V								
1.7 T	90		01.91	07.96														
2.0	80		08.93	07.96														
2.0	81		08.92	07.95														
	1.6	61		07.92	07.96	24.5170-0465.3	331331	2		L=465								
	1.7	64		09.88	07.96													
	1.7	66		09.90	07.96													
	1.7	75		08.89	07.92													
	1.7	80		08.89	07.92													
	1.7 T	88		08.89	07.96													
	1.7 T	90		01.91	07.96													
	1.8	66		08.91	07.96													
	1.9 TD	66		07.94	07.96													
	2.0	80		08.93	07.96													
2.0	81		08.92	07.95														
	1.7	75		08.89	07.92	11.0441-3303.2	250005			Dichtungssatz	ATE							
	1.7	80		08.89	07.92	11.0101-5402.2	260009			Hülzensatz	ATE							
	1.7 T	88		08.89	07.96	11.8171-0008.1	990049	2		Führungsbolzen	ATE							
	1.7 T	90		01.91	07.96	11.8116-0047.1	390494			Haltefeder	ATE							
	1.8	66		08.91	07.96													
	1.9 TD	66		07.94	07.96													
2.0	81		08.92	07.95														
	1.7	75		08.89	07.92	13.0460-3306.2	603306			21089 15,0 +	ATE							
	1.7	80		08.89	07.92													
	1.7 T	88		08.89	07.96													
	1.7 T	90		01.91	07.96													
	1.8	66		08.91	07.96													
	1.9 TD	66		07.94	07.96													
2.0	81		08.92	07.95														
	1.7	75		08.89	07.92	24.0109-0125.1	409125			228 9,0 8,0								
	1.7	80		08.89	07.92													
	1.7 T	88		08.89	07.96													
	1.7 T	90		01.91	07.96													
	1.8	66		08.91	07.96													
	1.9 TD	66		07.94	07.96													
2.0	81		08.92	07.95														
	1.6	61		07.92	07.96	- ABS	83.6104-0336.3	330451	2		L=335							
	1.7	64		09.88	07.96	- ABS												
	1.7	66		09.90	07.96	- ABS												
	1.7	75		08.89	07.92	- ABS/ + HA-Trommelbremse ³⁾												
	1.7	80		08.89	07.92	- ABS/ + HA-Trommelbremse ³⁾												
	1.8	66		08.91	07.96	- ABS/ + HA-Trommelbremse ³⁾												
	1.9 TD	66		07.94	07.96	- ABS/ + HA-Trommelbremse ³⁾												
	2.0	80		08.93	07.96	- ABS												
	1.6	61		07.92	08.92	+ ABS	83.6104-0295.3	330244	2		L=295							
	1.7	64		09.88	08.92	+ ABS												
1.7	66		09.90	08.92	+ ABS													
1.7	75		08.89	07.92	- ABS/ + HA-Scheibenbremse ⁴⁾													
1.7	75		08.89	07.92	+ ABS													
1.7	80		08.89	07.92	- ABS/ + HA-Scheibenbremse ⁴⁾													
1.7	80		08.89	07.92	+ ABS													
1.8	66		08.91	07.96	- ABS/ + HA-Scheibenbremse ⁴⁾													
1.8	66		08.91	08.92	+ ABS													
1.9 TD	66		07.94	07.96	- ABS/ + HA-Scheibenbremse ⁴⁾													
1.6	61		09.92	07.96	+ ABS	83.6124-0285.3	330722	2		L=285								
1.7	64		09.92	07.96	+ ABS													
1.7	66		09.92	07.96	+ ABS													
1.7 T	88		09.92	07.96	+ ABS													
1.7 T	90		08.92	07.96	+ ABS													
1.8	66		09.92	07.96	+ ABS													
1.9 TD	66		07.94	07.96	+ ABS													
2.0	80		08.93	07.96	+ ABS													
2.0	81		09.92	07.95	+ ABS													
	1.6	61		07.92	07.96	24.0721-1915.3	360149			Radsensor L=847								
	1.7	64		09.88	07.96	24.0721-1916.3	360150			Radsensor L=847								
	1.7	66		09.90	07.96													
	1.7	75		08.89	07.92													
	1.7	80		08.89	07.92													
	1.7 T	88		08.89	07.96													
	1.7 T	90		01.91	07.96													
	1.8	66		08.91	07.96													
	1.9 TD	66		07.94	07.96													
	2.0	80		08.93	07.96													
2.0	81		08.92	07.95														

¹⁾ only for Lucas calipers / solo per pinze Lucas / seulement pour étriers Lucas / solo para pinzas Lucas
²⁾ only for ATE calipers / solo per pinze ATE / seules pour étriers ATE / solo para pinzas ATE
³⁾ - ABS/ + RA drum brake / - ABS/ + P freno a tamburo / - ABS/ + fr. à tambour essieu AR / - ABS/ + ET tambores de freno
⁴⁾ - ABS/ + RA disc brake / - ABS/ + P disco freno / - ABS/ + fr. à disque essieu AR / - ABS/ + ET disco de freno

									
VOLVO 460 (88-96)									
	1.6 1.7 1.7 1.7 1.7 1.8 1.9 TD 2.0	61 64 66 75 80 66 66 80		07.92 09.88 09.90 08.89 08.89 08.91 07.94 08.93	07.96 07.96 07.96 07.92 07.92 07.96 07.96 07.96	24.3220-1113.3 020224		Rz 20,64	
	1.6 1.7 1.7 1.7 1.7 1.8 1.9 TD 2.0	61 64 66 75 80 66 66 80		07.92 09.88 09.90 08.89 08.89 08.91 07.94 08.93	07.96 07.96 07.96 07.92 07.92 07.96 07.96 07.96	03.0137-0258.2 03.0137-9158.2	650258 669158	203 x 38 HEB Bremsbacken-Zubehör LUC LUC	
	1.6 1.7 1.7 1.7 1.7 1.8 1.9 TD 2.0	61 64 66 75 80 66 66 80		07.92 09.88 09.90 08.89 08.89 08.91 07.94 08.93	07.96 07.96 07.96 07.92 07.92 07.96 07.96 07.96	24.0220-3015.1	480091	203/204,5 x 46,5	
	1.7 1.7 1.7 1.7	64 66 75 80	ELC 165500 ELC 165500 ELC 165500 ELC 165500	09.88 09.90 08.89 08.89		24.3727-1307.2	581307	2 + HA-Trommelbremse ¹⁾ + HA-Trommelbremse ¹⁾	L=1365
	1.6 1.7 1.7 1.7 1.7 1.8 1.9 TD 2.0	61 64 66 75 80 66 66 80	ELC 165501 ELC 165501 ELC 165501 ELC 165501	07.92 07.96 07.96 07.92 07.92 08.91 07.94 08.93	07.96 07.96 07.96 + HA-Trommelbremse ¹⁾ + HA-Trommelbremse ¹⁾ + HA-Trommelbremse ¹⁾ + HA-Trommelbremse ¹⁾ + HA-Trommelbremse ¹⁾	24.3727-1310.2	581310	2 + HA-Trommelbremse ¹⁾	L=1338
	1.7 1.7 1.7 T 1.7 T 1.8 1.9 TD 2.0	75 80 88 90 66 66 81	ELC 165501 ELC 165501 ELC 165501	07.92 07.92 07.96 01.91 08.91 07.94 08.92	+ HA-Scheibenbremse ²⁾ + HA-Scheibenbremse ²⁾ + HA-Scheibenbremse ²⁾ + HA-Scheibenbremse ²⁾ + HA-Scheibenbremse ²⁾	24.3727-1309.2	581309	2 + HA-Scheibenbremse ²⁾	L=1428
	1.6 1.7 1.7 1.7 1.7 1.7 1.7 T 1.7 T 1.8 2.0	61 64 66 75 80 88 90 66 81		07.92 09.88 09.90 08.89 08.89 08.89 01.91 08.91 08.92	08.92 08.92 08.92 08.92 08.92 08.92 08.92 08.92 08.92	03.0101-0014.2	320004	- ABS - ABS - ABS - ABS - ABS - ABS - ABS - ABS - ABS	BRES 3/25 ATE
	1.6 1.7 1.7 1.7 1.7 1.7 1.7 T 1.7 T 1.8 2.0 2.0	61 64 66 75 80 88 90 66 80 81	EMC 185081 EMC 185081 EMC 185081 EMC 185081 EMC 185081	07.92 07.96 07.96 07.92 07.92 07.96 01.91 08.91 08.93 08.92	07.96 07.96 07.96 07.92 07.92 07.96 07.96 07.96 07.96 07.95	24.3728-1303.2	591303		L=782
VOLVO 480 (86-96)									
	1.7 1.7 T 1.7 T 2.0	75 88 90 81		09.92 09.92 09.92 09.92	07.96 07.96 07.96 09.95	10.6120-0287.3	010334	+ ABS + ABS + ABS + ABS	THz 20,64 ATE
	1.7 1.7 1.7	70 75 78	EKC 538520 EKC 538520	08.89 08.89	07.89 07.96 07.89	24.0101-3601.2	260044		Bremssattel-Zubehör LUC
	1.7 T 1.7 T 2.0	88 90 81		08.87 01.91 08.92	07.96 07.96 09.95	11.9541-9806.2 11.8116-0073.1 11.8171-0008.1 11.0101-5407.2	220504 390498 990049 260011	2 D=54, - Halter Haltefeder Führungsbolzen Hülzensatz	ATE ATE ATE ATE
	1.7 1.7 1.7	70 78 80	EKC 538519 EKC 538519	08.87 04.86 08.86	07.88	13.0460-2846.2	602846		21010 15,8 /S LUC
	1.7 1.7 1.7	70 75 78	EKC 538520 EKC 538520	08.89 08.89	07.89 07.96 07.89	13.0460-2812.2	602812		21217 18,0 /S LUC
	1.7 T 1.7 T 2.0	88 90 81		08.87 01.91 08.92	07.96 07.96 09.95	13.0460-7146.2	607146		20147 17,0 + ATE

¹⁾ + RA drum brake / + P freno a tamburo / + frein à tambour essieu AR / + ET-tambores de freno
²⁾ + RA disc brake / + P disco freno / + frein à disque essieu AR / + ET-disco de freno

VOLVO 480 (86-96)								
	1.7 1.7 1.7 1.7 1.7 T 1.7 T 2.0	70 75 78 80 88 90 81		08.87 08.89 04.86 08.86 08.87 01.91 08.92	07.89 07.96 07.89 07.88 07.96 07.96 09.95	24.0112-0135.1 24.0112-0135.1 24.0122-0164.1 24.0122-0164.1	412135 412135 422164 422164	260 12,0 10,8 260 12,0 10,8 256 22,0 20,0 V 256 22,0 20,0 V
	1.7 1.7 1.7 1.7 1.7 T 1.7 T 2.0	70 75 78 80 88 90 81		08.87 08.89 09.86 08.86 08.86 01.91 08.92	07.89 07.96 07.89 07.88 07.96 07.96 09.95	24.5170-0465.3	331331	2 L=465
	1.7 1.7 1.7 1.7 1.7 T 1.7 T 2.0	70 75 78 80 88 90 81		08.87 08.89 04.86 08.86 08.86 01.91 08.92	07.89 07.96 07.89 07.88 07.96 07.96 09.95	11.0441-3303.2 11.0101-5402.2 11.8171-0008.1 11.8116-0047.1	250005 260009 990049 390494	2 Dichtungssatz Hülsensatz Führungsbolzen Haltefeder ATE ATE ATE ATE
	1.7 1.7 1.7 1.7 1.7 T 1.7 T 2.0	70 75 78 80 88 90 81		08.87 08.89 04.86 08.86 08.87 01.91 08.92	07.89 07.96 07.89 07.88 07.96 07.96 09.95	13.0460-3306.2	603306	21089 15,0 + ATE
	1.7 1.7 1.7 1.7 1.7 T 1.7 T 2.0	70 75 78 80 88 90 81		08.87 08.89 04.86 08.86 08.87 01.91 08.92	07.89 07.96 07.89 07.88 07.96 07.96 09.95	24.0109-0125.1	409125	228 9,0 8,0
	1.7 1.7 1.7 1.7 1.7 1.7 1.7 T 1.7 T 2.0	70 70 75 78 78 80 80 88 88 90 81	EJC 522771 EJC 522771 EJC 522771 EJC 522771	08.87 08.87 08.89 04.86 04.86 08.86 08.86 08.87 08.87 01.91 08.92	- ABS + ABS + ABS - ABS + ABS - ABS + ABS - ABS + ABS + ABS + ABS	83.6124-0285.3	330722	2 L=285
	1.7 1.7 1.7 1.7 1.7 T 1.7 T 2.0	70 75 78 80 88 90 81	EJC 522772 EJC 522772 EJC 522772 EJC 522772	08.89 08.89 07.89 07.88 07.96 01.91 08.92	- ABS - ABS - ABS - ABS - ABS - ABS - ABS	83.6104-0295.3	330244	2 L=295
	1.7 1.7 1.7 1.7 1.7 T 1.7 T 2.0	70 75 78 80 88 90 81		08.87 08.89 04.86 08.86 08.87 01.91 08.92	07.89 07.96 07.89 07.88 07.96 07.96 09.95	24.0721-1915.3 24.0721-1916.3	360149 360150	 Radsensor L=847 Radsensor L=847
	1.7 1.7 T 1.7 T 2.0	75 88 90 81		09.90 09.90 01.91 08.92	07.96 07.96 07.96 09.95	24.3727-1309.2	581309	2 L=1428
	1.7 1.7 1.7 1.7 1.7 T 1.7 T	70 75 78 80 88 90		08.87 08.89 04.86 08.86 08.87 01.91	08.92 - ABS 08.92 - ABS 07.89 - ABS 07.88 - ABS 08.92 - ABS 08.92 - ABS	03.0101-0014.2	320004	BRES 3/25 ATE
	1.7 1.7 T 1.7 T 2.0	75 88 90 81	EMC 565117 EMC 565117	07.96 07.96 01.91 08.92		24.3728-1303.2	591303	L=782
VOLVO 740 Limousine (83-92)								
	2.0 2.0 2.0 2.3 2.3 2.3 2.3 2.3 2.3	76 294100 89 294100 118 294100 83 294100 84 294100 85 294100 100 294100 111 294100		08.90 08.91 08.90 12.89 07.90 08.91 07.90 08.91	- ABS - ABS - ABS - ABS - ABS - ABS - ABS - ABS	03.2023-0503.3 03.3517-5100.1	010022 390326	THz 23,81/16,84 + B. Verschlußschraube ATE ATE

VOLVO 740 Limousine (83-92)

	2.3	114 294100		07.91	- ABS	03.2023-0503.3	010022		THz 23,81/16,84 + B.	ATE
	2.3	117 294100		07.89	- ABS	03.3517-5100.1	390326		Verschlußschraube	ATE
	2.3 T	115 294100		07.89	- ABS					
	2.3 T	121	08.89	07.90	- ABS					
	2.3 T	140	08.89	07.90	- ABS					
	2.4 D	60 294100		08.91	- ABS					
	2.4 TD	83 294100		07.90	- ABS					
	2.0	76	09.88	08.90	+ ABS	03.2023-0164.3	010014		THz 23,81/19,05 + B.	ATE
	2.0	89	09.87	08.91	+ ABS					
	2.0	118	09.87	08.90	+ ABS					
	2.3	83	09.87	12.89	+ ABS					
	2.3	84	09.87	07.90	+ ABS					
	2.3	85	09.87	08.91	+ ABS					
	2.3	100	08.88	07.90	+ ABS					
	2.3	111	08.88	08.91	+ ABS					
	2.3	114	08.88	07.91	+ ABS					
	2.3	117	09.87	07.89	+ ABS					
	2.3 T	115	09.87	07.89	+ ABS					
	2.3 T	121	08.89	07.90	+ ABS					
	2.3 T	134	09.87	12.88	+ ABS					
	2.3 T	140	08.89	07.90	+ ABS					
	2.4 D	60	09.87	08.91	+ ABS					
	2.4 TD	83	09.87	07.90	+ ABS					
	2.0	89	09.91	07.92		03.2023-0875.3	010890		THz 23,81/20,64 - B.	ATE
	2.3	85	09.91	07.92						
	2.3	111	09.91	07.92						
	2.4 D	60	09.91	07.92						
	2.0	76	09.88	08.90	- ABS	24.0101-3401.2	260043		Bremssattel-Zubehör	LUC
	2.0	86	01.87	08.88	- ABS					
	2.0	89	08.85	08.90	- ABS					
	2.0	110	12.83	07.84						
	2.0	118	01.86	08.90	- ABS					
	2.0	120	01.85	12.85						
	2.3	82	08.84	07.86						
	2.3	83	09.85	12.89	- ABS					
	2.3	84	08.84	07.90	- ABS					
	2.3	85	08.87	08.90	- ABS					
	2.3	86	08.86	07.88	- ABS					
	2.3	95	08.83	07.84						
	2.3	96	08.84	07.88	- ABS					
	2.3	100	08.88	07.90	- ABS					
	2.3	111	08.88	08.90	- ABS					
	2.3	114	08.88	08.90	- ABS					
	2.3	117	08.87	07.89	- ABS					
	2.3 T	115	08.86	07.89	- ABS					
	2.3 T	121	08.89	07.90	- ABS					
	2.3 T	134	08.85	12.88	- ABS					
	2.3 T	140	08.89	07.90	- ABS					
	2.4 D	60	08.84	08.90	- ABS					
	2.4 TD	80	08.85	07.87						
	2.4 TD	83	08.84	07.90	- ABS					
	2.4 TD	90	08.86	10.88	- ABS					
	2.0	86	09.87	08.88	+ ABS	24.0101-3401.2	260043		Bremssattel-Zubehör	LUC
	2.0	89	09.87	08.90	+ ABS					
	2.0	118	09.87	08.90	+ ABS					
	2.3	83	09.87	12.89	+ ABS					
	2.3	84	09.87	07.90	+ ABS					
	2.3	85	09.87	08.90	+ ABS					
	2.3	86	09.87	07.88	+ ABS					
	2.3	96	09.87	07.88	+ ABS					
	2.3	100	08.88	07.90	+ ABS					
	2.3	111	08.88	08.90	+ ABS					
	2.3	114	08.88	08.90	+ ABS					
	2.3	117	09.87	07.89	+ ABS					
	2.3 T	115	09.87	07.89	+ ABS					
	2.3 T	121	08.89	07.90	+ ABS					
	2.3 T	134	09.87	12.88	+ ABS					
	2.3 T	140	08.89	07.90	+ ABS					
	2.4 D	60	08.84	08.90	+ ABS					
	2.4 TD	83	08.84	07.90	+ ABS					
	2.4 TD	90	08.86	10.88	+ ABS					
	2.0	89	09.90	07.92	+ ABS	24.3571-1707.5	240079	<input type="checkbox"/>	D=57, - Halter	LUC
	2.3	85	09.90	07.92	+ ABS	24.3571-1708.5	240080	<input type="checkbox"/>	D=57, - Halter	LUC
	2.3	111	09.90	07.92	+ ABS	24.0101-3601.2	260044		Bremssattel-Zubehör	LUC
	2.3	114	09.90	07.91	+ ABS					
	2.4 D	60	09.90	07.92	+ ABS					
	2.0	76	09.88	08.90		13.0460-3914.2	603914		21233 16,7	BDX
	2.0	86	01.87	08.88		13.0460-2943.2	602943		21266 17,0 /S	LUC
	2.0	89	08.85	08.90		13.0460-0429.2	610429		Belagsatz-Zubehör	BDX
	2.0	89	09.90	07.92	- ABS					
	2.0	110	12.83	07.84						
	2.0	118	01.86	08.90						
	2.0	120	01.85	12.85						
	2.3	82	08.84	07.86						
	2.3	83	09.85	12.89						
	2.3	84	08.84	07.90						
	2.3	85	08.87	08.90						

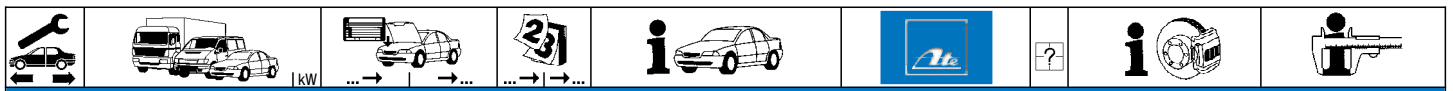

VOLVO 740 Limousine (83-92)

	2.3	85	09.90	07.92	- ABS	13.0460-3914.2	603914		21233 16,7	BDX
	2.3	86	08.86	07.88		13.0460-2943.2	602943		21266 17,0 / S	LUC
	2.3	95	08.83	07.84		13.0460-0429.2	610429		Belagsatz-Zubehör	BDX
	2.3	96	08.84	07.88						
	2.3	100	08.88	07.90						
	2.3	111	08.88	08.90						
	2.3	111	09.90	07.92	- ABS					
	2.3	114	08.88	08.90						
	2.3	114	09.90	07.91	- ABS					
	2.3	117	08.87	07.89						
	2.3 T	115	08.86	07.89						
	2.3 T	121	08.89	07.90						
	2.3 T	134	08.85	12.88						
	2.3 T	140	08.89	07.90						
	2.4 D	60	08.84	08.90						
	2.4 D	60	09.90	07.92	- ABS					
	2.4 TD	80	08.85	07.87						
	2.4 TD	83	08.84	07.90						
	2.4 TD	90	08.86	10.88						
2.0	89	09.90	07.92	+ ABS	13.0460-2985.2	602985		20164 18,2	LUC	
2.3	85	09.90	07.92	+ ABS						
2.3	111	09.90	07.92	+ ABS						
2.3	114	09.90	07.91	+ ABS						
2.4 D	60	09.90	07.92	+ ABS						
	2.0	86	01.87	07.87		24.0122-0217.2	422217	+ 14" Rad ¹⁾	263 22,0 20,0 V	
	2.0	89	08.85	07.87						
	2.0	110	12.83	07.84						
	2.0	118	01.86	07.87						
	2.0	120	01.85	12.85						
	2.3	82	08.84	07.86						
	2.3	83	09.85	07.87						
	2.3	84	08.84	07.87						
	2.3	86	08.86	07.87						
	2.3	95	08.83	07.84						
	2.3	96	08.84	07.87						
	2.3 T	115	08.86	07.87						
	2.3 T	134	08.85	07.87						
	2.4 D	60	08.84	07.87						
	2.4 TD	80	08.85	07.87						
	2.4 TD	83	08.84	07.87						
	2.4 TD	90	08.86	07.87						
	2.0	76	09.88	08.90		24.0122-0138.1	422138	+ 14" Rad ¹⁾	263 22,0 20,0 V	
	2.0	86	08.87	08.88		24.0122-0137.1	422137	+ 15" Rad ²⁾	287 22,0 20,0 V	
2.0	89	08.87	08.90							
2.0	118	08.87	08.90							
2.3	83	08.87	12.89							
2.3	84	08.87	07.90							
2.3	85	08.87	08.90							
2.3	86	08.87	07.88							
2.3	96	08.87	07.88							
2.3	100	08.88	07.90							
2.3	111	08.88	08.90							
2.3	114	08.88	08.90							
2.3	117	08.87	07.89							
2.3 T	115	08.86	07.89							
2.3 T	121	08.89	07.90							
2.3 T	134	08.87	12.88							
2.3 T	140	08.89	07.90							
2.4 D	60	08.87	08.90							
2.4 TD	80	08.85	07.87							
2.4 TD	83	08.87	07.90							
2.4 TD	90	08.87	10.88							
2.0	89	09.90	07.92	- ABS	24.0122-0137.1	422137		287 22,0 20,0 V		
2.3	85	09.90	07.92	- ABS						
2.3	111	09.90	07.92	- ABS						
2.3	114	09.90	07.91	- ABS						
2.4 D	60	09.90	07.92	- ABS						
2.0	89	09.90	07.92	+ ABS	24.0126-0105.1	426105		280 26,0 23,0 V +B		
2.3	85	09.90	07.92	+ ABS						
2.3	111	09.90	07.92	+ ABS						
2.3	114	09.90	07.91	+ ABS						
2.4 D	60	09.90	07.92	+ ABS						
	2.0	76	09.88	08.90	- ABS	83.6134-0335.3	330277	4	L=335	
	2.0	86	01.87	08.88	- ABS					
	2.0	89	08.85	08.90	- ABS					
	2.0	110	12.83	07.84						
	2.0	118	01.86	08.90	- ABS					
	2.0	120	01.85	12.85						
	2.3	82	08.84	07.86						
	2.3	83	09.85	12.89	- ABS					
	2.3	84	08.84	07.90	- ABS					
	2.3	85	08.87	07.92	- ABS					
	2.3	86	08.86	07.88	- ABS					
	2.3	95	08.83	07.84						
	2.3	96	08.84	07.88	- ABS					
2.3	100	08.88	07.90	- ABS						
2.3	111	08.88	07.92	- ABS						

¹⁾ + 14" wheel / + ruota 14" / + roue 14" / + rueda 14"

²⁾ + 15" wheel / + ruota 15" / + roue 15" / + rueda 15"



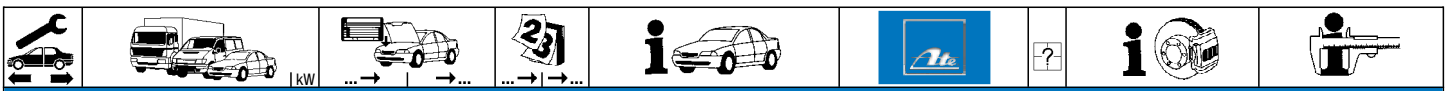

VOLVO 740 Limousine (83-92)

VOLVO 740 Limousine (83-92)										
	2.3	114	08.88	07.91	- ABS	83.6134-0335.3	330277	4	L=335	
	2.3	117	08.87	07.89	- ABS					
	2.3 T	115	08.86	07.89	- ABS					
	2.3 T	121	08.89	07.90	- ABS					
	2.3 T	134	08.85	12.88	- ABS					
	2.3 T	140	08.89	07.90	- ABS					
	2.4 D	60	08.84	07.92	- ABS					
	2.4 TD	80	08.85	07.87	- ABS					
	2.4 TD	83	08.84	07.90	- ABS					
	2.4 TD	90	08.86	10.88	- ABS					
	2.0	76	09.88	08.90	+ ABS	83.6134-0335.3	330277	2	L=335	
	2.0	86	01.87	08.88	+ ABS					
	2.0	89	08.85	08.90	+ ABS					
	2.0	118	01.86	08.90	+ ABS					
	2.3	83	09.85	12.89	+ ABS					
	2.3	84	08.84	07.90	+ ABS					
	2.3	85	08.87	07.92	+ ABS					
	2.3	86	08.86	07.88	+ ABS					
	2.3	96	08.84	07.88	+ ABS					
	2.3	100	08.88	07.90	+ ABS					
	2.3	111	08.88	07.92	+ ABS					
	2.3	114	08.88	07.91	+ ABS					
	2.3	117	08.87	07.89	+ ABS					
	2.3 T	115	08.86	07.89	+ ABS					
	2.3 T	121	08.89	07.90	+ ABS					
	2.3 T	134	08.85	12.88	+ ABS					
	2.3 T	140	08.89	07.90	+ ABS					
	2.4 D	60	08.84	07.92	+ ABS					
	2.4 TD	83	08.84	07.90	+ ABS					
	2.4 TD	90	08.86	10.88	+ ABS					
	2.0	86	01.87	07.87		24.9236-0001.5	230005		D=36	ATE
	2.0	89	08.85	07.87		24.9236-0002.5	230006		D=36	ATE
	2.0	110	12.83	07.84		24.9238-0087.5	230035		D=38	ATE
	2.0	118	01.86	07.87		24.9238-0088.5	230036		D=38	ATE
	2.0	120	01.85	12.85		13.2401-0027.2	210045		D=40	ATE
	2.3	82	08.84	07.86		13.2401-0028.2	210046		D=40	ATE
	2.3	83	09.85	07.87		24.9240-0028.5	230018		D=40	ATE
	2.3	84	08.84	07.87		13.0441-3815.2	250069		D=38	ATE
	2.3	86	08.86	07.87		13.0441-3819.2	250072		D=38	ATE
	2.3	95	08.83	07.84		13.0441-4014.2	250079		D=38	ATE
	2.3	96	08.84	07.87					für Vorg. 13.2381-0067/-0068.2 ¹⁾	Dichtungssatz
	2.3 T	115	08.86	07.87					D=38	Dichtungssatz
	2.3 T	134	08.85	07.87					für Vorg. 13.2401-0023/-0024.2 ²⁾	Dichtungssatz
	2.4 D	60	08.84	07.87						
	2.4 TD	80	08.85	07.87						
	2.4 TD	83	08.84	07.87						
	2.4 TD	90	08.86	07.87						
	2.0	76	09.88	08.90	+ Starrachse ³⁾	24.9238-0087.5	230035		D=38	ATE
	2.0	86	08.87	08.88	+ Starrachse ³⁾	24.9238-0088.5	230036		D=38	ATE
	2.0	89	08.87	08.90	+ Starrachse ³⁾	13.2401-0027.2	210045		D=40	ATE
	2.0	89	09.90	07.92		13.2401-0028.2	210046		D=40	ATE
	2.0	118	08.87	08.90	+ Starrachse ³⁾	24.9240-0028.5	230018		D=40	ATE
	2.3	83	08.87	12.89	+ Starrachse ³⁾	13.0441-3815.2	250069		D=38	ATE
	2.3	84	08.87	07.90	+ Starrachse ³⁾	13.0441-3819.2	250072		D=38	ATE
	2.3	85	08.87	08.90	+ Starrachse ³⁾	13.0441-4014.2	250079		D=38	ATE
	2.3	85	09.90	07.92					für Vorg. 13.2401-0023/-0024.2 ²⁾	Dichtungssatz
	2.3	86	08.87	07.88	+ Starrachse ³⁾					
	2.3	96	08.87	07.88	+ Starrachse ³⁾					
	2.3	100	08.88	07.90	+ Starrachse ³⁾					
	2.3	111	08.88	08.90	+ Starrachse ³⁾					
	2.3	111	09.90	07.92						
	2.3	114	08.88	08.90	+ Starrachse ³⁾					
	2.3	114	09.90	07.91						
	2.3	117	08.87	07.89	+ Starrachse ³⁾					
	2.3 T	115	08.86	07.89	+ Starrachse ³⁾					
	2.3 T	121	08.89	07.90	+ Starrachse ³⁾					
	2.3 T	134	08.87	12.88	+ Starrachse ³⁾					
	2.3 T	140	08.89	07.90	+ Starrachse ³⁾					
	2.4 D	60	08.87	08.90	+ Starrachse ³⁾					
	2.4 D	60	09.90	07.92						
	2.4 TD	80	08.85	07.87	+ Starrachse ³⁾					
	2.4 TD	83	08.87	07.90	+ Starrachse ³⁾					
	2.4 TD	90	08.87	10.88	+ Starrachse ³⁾					
	2.0	76	09.88	08.90	+ Starrachse ³⁾	13.0460-3401.2	603401		20755 14,4	ATE
	2.0	86	01.87	08.88	+ Starrachse ³⁾	13.0460-0088.2	610088		Belagsatz-Zubehör	ATE
	2.0	89	08.85	08.90	+ Starrachse ³⁾					
	2.0	89	09.90	07.92						
	2.0	110	12.83	07.84						
	2.0	118	01.86	08.90	+ Starrachse ³⁾					
	2.0	120	01.85	12.85						
	2.3	82	08.84	07.86						
	2.3	83	09.85	12.89	+ Starrachse ³⁾					
	2.3	84	08.84	07.90	+ Starrachse ³⁾					
	2.3	85	08.87	08.90	+ Starrachse ³⁾					
	2.3	85	09.90	07.92						
	2.3	86	08.86	07.88	+ Starrachse ³⁾					
	2.3	95	08.83	07.84						

¹⁾ f.predec.13.2381-0067/-0068.2 / p.prece.13.2381-0067.2/-0068.2 / p.préd.13.2381-0067.2/-0068.2 / p.prede.13.2381-0067.2/-0068.2

²⁾ f.predec.13.2401-0023/-0024.2 / p.prece.13.2401-0023.2/-0024.2 / p.préd.13.2401-0023.2/-0024.2 / p.prede.13.2401-0023.2/-0024.2

³⁾ + rigid axle / + assale rigido / + essieu rigide / + eje rigido



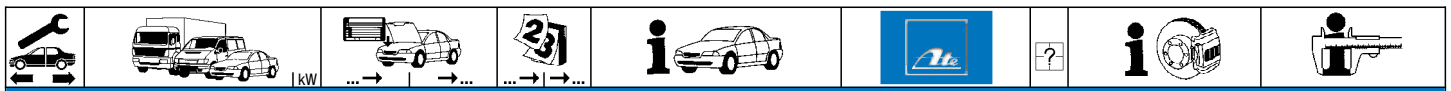

VOLVO 740 Limousine (83-92)

	2.3	96	08.84	07.88	+ Starrachse ¹⁾	13.0460-3401.2	603401		20755 14,4	ATE
	2.3	100	08.88	07.90	+ Starrachse ¹⁾	13.0460-0088.2	610088		Belagsatz-Zubehör	ATE
	2.3	111	08.88	08.90	+ Starrachse ¹⁾					
	2.3	111	09.90	07.92						
	2.3	114	08.88	08.90	+ Starrachse ¹⁾					
	2.3	114	09.90	07.91						
	2.3	117	08.87	07.89	+ Starrachse ¹⁾					
	2.3 T	115	08.86	07.89	+ Starrachse ¹⁾					
	2.3 T	121	08.89	07.90	+ Starrachse ¹⁾					
	2.3 T	134	08.85	12.88	+ Starrachse ¹⁾					
	2.3 T	140	08.89	07.90	+ Starrachse ¹⁾					
	2.4 D	60	08.84	08.90	+ Starrachse ¹⁾					
	2.4 D	60	09.90	07.92						
	2.4 TD	80	08.85	07.87	+ Starrachse ¹⁾					
	2.4 TD	83	08.84	07.90	+ Starrachse ¹⁾					
	2.4 TD	90	08.86	10.88	+ Starrachse ¹⁾					
	2.0	76	09.88	08.90	+ Multi-Link-Achse ²⁾	13.0460-2935.2	602935		21385 13,8 /S	LUC
	2.0	86	08.87	08.88	+ Multi-Link-Achse ²⁾					
	2.0	89	08.87	08.90	+ Multi-Link-Achse ²⁾					
	2.0	118	08.87	08.90	+ Multi-Link-Achse ²⁾					
	2.3	83	08.87	12.89	+ Multi-Link-Achse ²⁾					
	2.3	84	08.87	07.90	+ Multi-Link-Achse ²⁾					
	2.3	85	08.87	08.90	+ Multi-Link-Achse ²⁾					
	2.3	86	08.87	07.88	+ Multi-Link-Achse ²⁾					
	2.3	96	08.87	07.88	+ Multi-Link-Achse ²⁾					
	2.3	100	08.88	07.90	+ Multi-Link-Achse ²⁾					
	2.3	111	08.88	08.90	+ Multi-Link-Achse ²⁾					
	2.3	114	08.88	08.90	+ Multi-Link-Achse ²⁾					
	2.3	117	08.87	07.89	+ Multi-Link-Achse ²⁾					
	2.3 T	115	08.86	07.89	+ Multi-Link-Achse ²⁾					
	2.3 T	121	08.89	07.90	+ Multi-Link-Achse ²⁾					
	2.3 T	134	08.87	12.88	+ Multi-Link-Achse ²⁾					
	2.3 T	140	08.89	07.90	+ Multi-Link-Achse ²⁾					
	2.4 D	60	08.87	08.90	+ Multi-Link-Achse ²⁾					
	2.4 TD	80	08.85	07.87	+ Multi-Link-Achse ²⁾					
	2.4 TD	83	08.87	07.90	+ Multi-Link-Achse ²⁾					
	2.4 TD	90	08.87	10.88	+ Multi-Link-Achse ²⁾					
	2.0	76	09.88	08.90	+ Starrachse ¹⁾	24.0110-0189.1	410189		281 9,6 8,4 +B	
	2.0	86	01.87	08.88	+ Starrachse ¹⁾					
	2.0	89	08.85	08.90	+ Starrachse ¹⁾					
	2.0	89	09.90	07.92						
	2.0	110	12.83	07.84						
	2.0	118	01.86	08.90	+ Starrachse ¹⁾					
	2.0	120	01.85	12.85						
	2.3	82	08.84	07.86						
	2.3	83	09.85	12.89	+ Starrachse ¹⁾					
	2.3	84	08.84	07.90	+ Starrachse ¹⁾					
	2.3	85	08.87	08.90	+ Starrachse ¹⁾					
	2.3	85	09.90	07.92						
	2.3	86	08.86	07.88	+ Starrachse ¹⁾					
	2.3	95	08.83	07.84						
	2.3	96	08.84	07.88	+ Starrachse ¹⁾					
	2.3	100	08.88	07.90	+ Starrachse ¹⁾					
	2.3	111	08.88	08.90	+ Starrachse ¹⁾					
	2.3	111	09.90	07.92						
	2.3	114	08.88	08.90	+ Starrachse ¹⁾					
	2.3	114	09.90	07.91						
	2.3	117	08.87	07.89	+ Starrachse ¹⁾					
	2.3 T	115	08.86	07.89	+ Starrachse ¹⁾					
	2.3 T	121	08.89	07.90	+ Starrachse ¹⁾					
	2.3 T	134	08.85	12.88	+ Starrachse ¹⁾					
	2.3 T	140	08.89	07.90	+ Starrachse ¹⁾					
	2.4 D	60	08.84	08.90	+ Starrachse ¹⁾					
	2.4 D	60	09.90	07.92						
	2.4 TD	80	08.85	07.87	+ Starrachse ¹⁾					
	2.4 TD	83	08.84	07.90	+ Starrachse ¹⁾					
	2.4 TD	90	08.86	10.88	+ Starrachse ¹⁾					
	2.0	76	09.88	08.90	+ Multi-Link-Achse ²⁾	24.0110-0206.1	410206		265 10,0 8,0	
	2.0	86	08.87	08.88	+ Multi-Link-Achse ²⁾					
	2.0	89	08.87	08.90	+ Multi-Link-Achse ²⁾					
	2.0	118	08.87	08.90	+ Multi-Link-Achse ²⁾					
	2.3	83	08.87	12.89	+ Multi-Link-Achse ²⁾					
	2.3	84	08.87	07.90	+ Multi-Link-Achse ²⁾					
	2.3	85	08.87	08.90	+ Multi-Link-Achse ²⁾					
	2.3	86	08.87	07.88	+ Multi-Link-Achse ²⁾					
	2.3	96	08.87	07.88	+ Multi-Link-Achse ²⁾					
	2.3	100	08.88	07.90	+ Multi-Link-Achse ²⁾					
	2.3	111	08.88	08.90	+ Multi-Link-Achse ²⁾					
	2.3	114	08.88	08.90	+ Multi-Link-Achse ²⁾					
	2.3	117	08.87	07.89	+ Multi-Link-Achse ²⁾					
	2.3 T	115	08.86	07.89	+ Multi-Link-Achse ²⁾					
	2.3 T	121	08.89	07.90	+ Multi-Link-Achse ²⁾					
	2.3 T	134	08.87	12.88	+ Multi-Link-Achse ²⁾					
	2.3 T	140	08.89	07.90	+ Multi-Link-Achse ²⁾					
	2.4 D	60	08.87	08.90	+ Multi-Link-Achse ²⁾					
	2.4 TD	80	08.85	07.87	+ Multi-Link-Achse ²⁾					
	2.4 TD	83	08.87	07.90	+ Multi-Link-Achse ²⁾					

¹⁾ + rigid axle / + assale rigido / + essieu rigide / + eje rígido
²⁾ + multi link axle / + assale Multi-link / + essieu multi-link / + eje Multi-Link



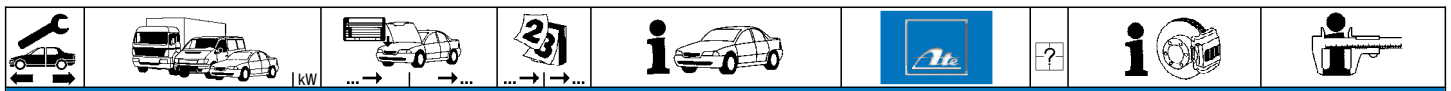











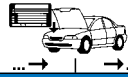

VOLVO 740 Limousine (83-92)

	2.4 TD	90		08.87	10.88	+ Multi-Link-Achse ¹⁾	24.0110-0206.1	410206		265 10,0 8,0
	2.0	76		09.88	08.90		83.6124-0305.3	330723	2	L=305
	2.0	86		01.87	08.88					
	2.0	89		08.85	07.92					
	2.0	110		12.83	07.84					
	2.0	118		01.86	08.90					
	2.0	120		01.85	12.85					
	2.3	82		08.84	07.86					
	2.3	83		09.85	12.89					
	2.3	84		08.84	07.90					
	2.3	85		08.87	07.92					
	2.3	86		08.86	07.88					
	2.3	95		08.83	07.84					
	2.3	96		08.84	07.88					
	2.3	100		08.88	07.90					
	2.3	111		08.88	07.92					
	2.3	114		08.88	07.91					
	2.3	117		08.87	07.89					
	2.3 T	115		08.86	07.89					
	2.3 T	121		08.89	07.90					
	2.3 T	134		08.85	12.88					
	2.3 T	140		08.89	07.90					
	2.4 D	60		08.84	07.92					
	2.4 TD	80		08.85	07.87	- ABS				
	2.4 TD	83		08.84	07.90	- ABS				
	2.4 TD	90		08.86	10.88	- ABS				
	2.4 TD	80		08.85	07.87	+ ABS	83.6134-0300.3	330725	2	L=300
	2.4 TD	83		08.84	07.90	+ ABS				
	2.4 TD	90		08.86	10.88	+ ABS				
	2.0	76		09.88	08.90	+ Starrachse ²⁾	03.0137-0169.2	650169		160 x 25 Bremsbacken-Zubehör
	2.0	86		01.87	08.88	+ Starrachse ²⁾	03.0137-9065.2	669065		
	2.0	89		08.85	08.90	+ Starrachse ²⁾				
	2.0	89		09.90	07.92					
	2.0	110		12.83	07.84					
	2.0	118		01.86	08.90	+ Starrachse ²⁾				
	2.0	120		01.85	12.85					
	2.3	82		08.84	07.86					
	2.3	83		09.85	12.89	+ Starrachse ²⁾				
	2.3	84		08.84	07.90	+ Starrachse ²⁾				
	2.3	85		08.87	08.90	+ Starrachse ²⁾				
	2.3	85		09.90	07.92					
	2.3	86		08.86	07.88	+ Starrachse ²⁾				
	2.3	95		08.83	07.84					
	2.3	96		08.84	07.88	+ Starrachse ²⁾				
	2.3	100		08.88	07.90	+ Starrachse ²⁾				
	2.3	111		08.88	08.90	+ Starrachse ²⁾				
	2.3	111		09.90	07.92					
	2.3	114		08.88	08.90	+ Starrachse ²⁾				
	2.3	114		09.90	07.91					
	2.3	117		08.87	07.89	+ Starrachse ²⁾				
	2.3 T	115		08.86	07.89	+ Starrachse ²⁾				
	2.3 T	121		08.89	07.90	+ Starrachse ²⁾				
	2.3 T	134		08.85	12.88	+ Starrachse ²⁾				
	2.3 T	140		08.89	07.90	+ Starrachse ²⁾				
	2.4 D	60		08.84	08.90	+ Starrachse ²⁾				
	2.4 D	60		09.90	07.92					
	2.4 TD	80		08.85	07.87	+ Starrachse ²⁾				
	2.4 TD	83		08.84	07.90	+ Starrachse ²⁾				
	2.4 TD	90		08.86	10.88	+ Starrachse ²⁾				
	2.0	76		09.88	08.90	+ Multi-Link-Achse ¹⁾	03.0137-0299.2	650299		160 x 25 Bremsbacken-Zubehör
	2.0	86		08.87	08.88	+ Multi-Link-Achse ¹⁾	03.0137-9199.2	669199		
	2.0	89		08.87	08.90	+ Multi-Link-Achse ¹⁾				
	2.0	118		08.87	08.90	+ Multi-Link-Achse ¹⁾				
	2.3	83		08.87	12.89	+ Multi-Link-Achse ¹⁾				
	2.3	84		08.87	07.90	+ Multi-Link-Achse ¹⁾				
	2.3	85		08.87	08.90	+ Multi-Link-Achse ¹⁾				
	2.3	86		08.87	07.88	+ Multi-Link-Achse ¹⁾				
	2.3	96		08.87	07.88	+ Multi-Link-Achse ¹⁾				
	2.3	100		08.88	07.90	+ Multi-Link-Achse ¹⁾				
	2.3	111		08.88	08.90	+ Multi-Link-Achse ¹⁾				
	2.3	114		08.88	08.90	+ Multi-Link-Achse ¹⁾				
	2.3	117		08.87	07.89	+ Multi-Link-Achse ¹⁾				
	2.3 T	115		08.86	07.89	+ Multi-Link-Achse ¹⁾				
	2.3 T	121		08.89	07.90	+ Multi-Link-Achse ¹⁾				
	2.3 T	134		08.87	12.88	+ Multi-Link-Achse ¹⁾				
	2.3 T	140		08.89	07.90	+ Multi-Link-Achse ¹⁾				
	2.4 D	60		08.87	08.90	+ Multi-Link-Achse ¹⁾				
	2.4 TD	80		08.85	07.87	+ Multi-Link-Achse ¹⁾				
	2.4 TD	83		08.87	07.90	+ Multi-Link-Achse ¹⁾				
	2.4 TD	90		08.87	10.88	+ Multi-Link-Achse ¹⁾				
	2.0	86		01.87	07.87		24.3727-1306.2	581306	<input type="checkbox"/>	L=830
	2.0	89		08.85	07.87					
	2.0	110		12.83	07.84					
	2.0	118		01.86	07.87					
	2.0	120		01.85	12.85					

¹⁾ + multi link axle / + assale Multi-link / + essieu multi-link / + eje Multi-Link
²⁾ + rigid axle / + assale rigido / + essieu rigide / + eje rigido



VOLVO 740 Limousine (83-92)									
									
	2.3	82		08.84	07.86	24.3727-1306.2	581306	<input type="checkbox"/>	L=830
	2.3	83		09.85	07.87				
	2.3	84		08.84	07.87				
	2.3	86		08.86	07.87				
	2.3	95		08.83	07.84				
	2.3	96		08.84	07.87				
	2.3 T	115		08.86	07.87				
	2.3 T	134		08.85	07.87				
	2.4 D	60		08.84	07.87				
	2.4 TD	80		08.85	07.87				
	2.4 TD	83		08.84	07.87				
	2.4 TD	90		08.86	07.87				
	2.0	76		09.88	08.90	03.6055-0431.3	320142		BR 5/35 (4) ATE
	2.0	86		01.87	08.88				
	2.0	89		08.85	07.92				
	2.0	110		12.83	07.84				
	2.0	118		01.86	08.90				
	2.0	120		01.85	12.85				
	2.0	120		01.85	12.85				
	2.0	86		01.87	07.87	24.2419-0928.3	030056		Gz 19,05
	2.0	89		08.85	07.87				
	2.0	110		12.83	07.84				
	2.0	118		01.86	07.87				
	2.0	120		01.85	12.85				
	2.3	82		08.84	07.86				
	2.3	83		09.85	07.87				
	2.3	84		08.84	07.87				
	2.3	86		08.86	07.87				
	2.3	95		08.83	07.84				
	2.3	96		08.84	07.87				
	2.3 T	115		08.86	07.87				
	2.3 T	134		08.85	07.87				
	2.4 D	60		08.84	07.87				
	2.4 TD	80		08.85	07.87				
	2.4 TD	83		08.84	07.87				
	2.4 TD	90		08.86	07.87				
	2.0	76		09.88	08.90	24.2419-0941.3	030067		Gz 19,05
	2.0	86		08.87	08.88				
	2.0	89		08.85	07.92				
	2.0	110		12.83	07.84				
	2.0	118		01.86	08.90				
	2.0	120		01.85	12.85				
	2.3	82		08.84	07.86				
	2.3	83		09.85	12.89				
	2.3	84		08.84	07.90				
	2.3	85		08.87	07.92				
	2.3	86		08.86	07.88				
	2.3	95		08.83	07.84				
	2.3	96		08.84	07.88				
	2.3	100		08.88	07.90				
	2.3	111		08.88	07.92				
	2.3	114		08.88	07.91				
	2.3	117		08.87	07.89				
	2.3 T	115		08.86	07.89				
	2.3 T	121		08.89	07.90				
	2.3 T	134		08.85	12.88				
	2.3 T	140		08.89	07.90				
	2.4 D	60		08.84	07.92				
	2.4 TD	80		08.85	07.87				
	2.4 TD	83		08.84	07.90				
	2.4 TD	90		08.86	10.88				
	2.0	86		01.87	07.87	03.2522-0420.3	040086		Nz 22,20
	2.0	89		08.85	07.87				
	2.0	110		12.83	07.84				
	2.0	118		01.86	07.87				
	2.0	120		01.85	12.85				
	2.3	82		08.84	07.86				
	2.3	83		09.85	07.87				
	2.3	84		08.84	07.87				
	2.3	86		08.86	07.87				
	2.3	95		08.83	07.84				
	2.3	96		08.84	07.87				
	2.3 T	115		08.86	07.87				
	2.3 T	134		08.85	07.87				
	2.4 D	60		08.84	07.87				
	2.4 TD	80		08.85	07.87				
	2.4 TD	83		08.84	07.87				
	2.4 TD	90		08.86	07.87				
	2.0	76		09.88	08.90	24.2520-0905.3	040057		Nz 20,64
	2.0	86		08.87	08.88				
	2.0	89		08.85	07.92				
	2.0	110		12.83	07.84				
	2.0	118		01.86	08.90				
	2.0	120		01.85	12.85				
	2.3	82		08.84	07.86				
	2.3	83		09.85	12.89				
	2.3	84		08.84	07.90				
	2.3	85		08.87	07.92				



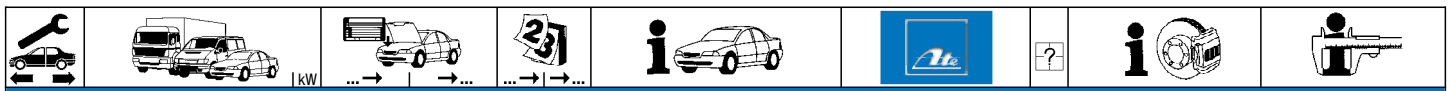

VOLVO 740 Limousine (83-92)

	2.3	86	08.86	07.88	24.2520-0905.3	040057		Nz 20,64
	2.3	95	08.83	07.84				
	2.3	96	08.84	07.88				
	2.3	100	08.88	07.90				
	2.3	111	08.88	07.92				
	2.3	114	08.88	07.91				
	2.3	117	08.87	07.89				
	2.3 T	115	08.86	07.89				
	2.3 T	121	08.89	07.90				
	2.3 T	134	08.85	12.88				
	2.3 T	140	08.89	07.90				
	2.4 D	60	08.84	07.92				
	2.4 TD	80	08.85	07.87				
	2.4 TD	83	08.84	07.90				
	2.4 TD	90	08.86	10.88				
	2.4 D	60	08.84	08.90	24.3728-1301.2	591301		L=1100
	2.4 TD	80	08.85	07.87				
	2.4 TD	83	08.84	07.90				
	2.4 TD	90	08.86	10.88				

VOLVO 740 Kombi (85-92)

	2.0	76 176800	08.89	08.90 - ABS	03.2023-0503.3	010022		THz 23,81/16,84 + B. ATE
	2.0	82		07.91 - ABS	03.3517-5100.1	390326		Verschlußschraube ATE
	2.0	86 176800		08.88 - ABS				
	2.0	89 176800		08.91 - ABS				
	2.3	83 176800		12.89 - ABS				
	2.3	84 176800		07.90 - ABS				
	2.3	85 176800		08.91 - ABS				
	2.3	96 176800		07.88 - ABS				
	2.3	100	08.89	07.90 - ABS				
	2.3	111	07.89	08.91 - ABS				
	2.3	114 176800		07.90 - ABS				
	2.3	117 176800		07.89 - ABS				
	2.3 T	115 176800		07.89 - ABS				
	2.3 T	121	08.89	07.90 - ABS				
	2.3 T	134 176800		07.88 - ABS				
	2.3 T	140	08.89	07.90 - ABS				
	2.4 D	60 176800		07.88 - ABS				
	2.4 TD	80 176800		08.91 - ABS				
	2.4 TD Intercooler	90 176800		07.88 - ABS				
	2.0	76	09.88	08.90 + ABS	03.2023-0164.3	010014		THz 23,81/19,05 + B. ATE
	2.0	82	08.89	07.91 + ABS				
	2.0	86	09.87	08.88 + ABS				
	2.0	89	09.87	08.91 + ABS				
	2.3	83	09.87	12.89 + ABS				
	2.3	84	09.87	07.90 + ABS				
	2.3	85	09.87	08.91 + ABS				
	2.3	96	09.87	07.88 + ABS				
	2.3	100	08.89	07.90 + ABS				
	2.3	111	07.89	08.91 + ABS				
	2.3	114	08.88	07.90 + ABS				
	2.3	117	09.87	07.89 + ABS				
	2.3 T	115	09.87	07.89 + ABS				
	2.3 T	121	08.89	07.90 + ABS				
	2.3 T	134	09.87	07.88 + ABS				
	2.3 T	140	08.89	07.90 + ABS				
	2.4 D	60	09.87	07.88 + ABS				
	2.4 TD	80	09.87	08.91 + ABS				
	2.4 TD Intercooler	90	09.87	07.88 + ABS				
	2.0	89	09.91	07.92	03.2023-0875.3	010890		THz 23,81/20,64 - B. ATE
	2.3	85	09.91	07.92				
	2.3	111	07.89	07.92				
	2.4 TD	80	09.91	07.92				
	2.0	76	09.88	08.90 - ABS	24.0101-3401.2	260043		Bremssattel-Zubehör LUC
	2.0	82	08.89	08.90 - ABS				
	2.0	86	01.87	08.88 - ABS				
	2.0	89	08.85	08.90 - ABS				
	2.3	82	08.85	07.86				
	2.3	83	08.85	12.89 - ABS				
	2.3	84	09.85	07.90 - ABS				
	2.3	85	08.87	08.90 - ABS				
	2.3	96	08.85	07.88 - ABS				
	2.3	100	08.89	07.90 - ABS				
	2.3	111	07.89	08.90 - ABS				
	2.3	114	08.88	07.90 - ABS				
	2.3	117	08.87	07.89 - ABS				
	2.3 T	115	08.86	07.89 - ABS				
	2.3 T	121	08.89	07.90 - ABS				
	2.3 T	134	08.85	07.88 - ABS				
	2.3 T	140	08.89	07.90 - ABS				
	2.4 D	60	08.85	07.88 - ABS				
	2.4 TD	80	09.85	08.90 - ABS				
	2.4 TD Intercooler	90	08.86	07.88 - ABS				
	2.0	82	09.90	07.91 + ABS	24.3571-1707.5	240079		D=57, - Halter LUC
	2.0	89	09.90	07.92 + ABS	24.3571-1708.5	240080		D=57, - Halter LUC
	2.3	85	09.90	07.92 + ABS	24.0101-3601.2	260044		Bremssattel-Zubehör LUC
	2.3	111	09.90	07.92 + ABS				



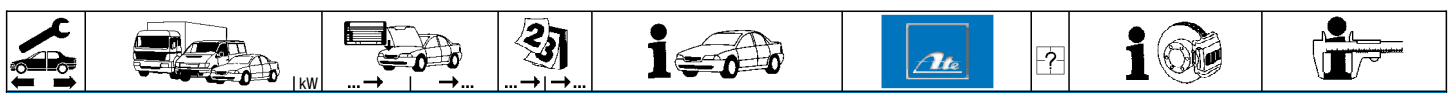

VOLVO 740 Kombi (85-92)

	2.4 TD	80		09.90	07.92 + ABS	24.3571-1707.5	240079		D=57, - Halter	LUC
						24.3571-1708.5	240080		D=57, - Halter	LUC
						24.0101-3601.2	260044		Bremssattel-Zubehör	LUC
	2.0	76		09.88	08.90	13.0460-3914.2	603914		21233 16,7	BDX
	2.0	82		08.89	08.90	13.0460-2943.2	602943		21266 17,0 / S	LUC
	2.0	86		01.87	08.88	13.0460-0429.2	610429		Belagsatz-Zubehör	BDX
	2.0	89		08.85	08.90					
	2.0	89		09.90	07.92 - ABS					
	2.3	82		09.90	07.91 - ABS					
	2.3	82		08.85	07.86					
	2.3	83		08.85	12.89					
	2.3	84		09.85	07.90					
	2.3	85		08.87	08.90					
	2.3	85		09.90	07.92 - ABS					
	2.3	96		08.85	07.88					
	2.3	100		08.89	07.90					
	2.3	111		07.89	08.90					
	2.3	111		09.90	07.92 - ABS					
	2.3	114		08.88	07.90					
	2.3	117		08.87	07.89					
	2.3 T	115		08.86	07.89					
	2.3 T	121		08.89	07.90					
	2.3 T	134		08.85	07.88					
	2.3 T	140		08.89	07.90					
	2.4 D	60		08.85	07.88					
	2.4 TD	80		09.85	08.90					
	2.4 TD	80		09.90	07.92 - ABS					
	2.4 TD Intercooler	90		08.86	07.88					
	2.0	82		09.90	07.91 + ABS	13.0460-2985.2	602985		20164 18,2	LUC
	2.0	89		09.90	07.92 + ABS					
	2.3	85		09.90	07.92 + ABS					
	2.3	111		09.90	07.92 + ABS					
	2.4 TD	80		09.90	07.92 + ABS					
	2.0	86		01.87	07.87	24.0122-0217.2	422217	+ 14" Rad ¹⁾	263 22,0 20,0 V	
	2.0	89		08.85	07.87					
	2.3	82		08.85	07.86					
	2.3	83		08.85	07.87					
	2.3	84		09.85	07.87					
	2.3	96		08.85	07.87					
	2.3 T	115		08.86	07.87					
	2.3 T	134		08.85	07.87					
	2.4 D	60		08.85	07.87					
	2.4 TD	80		09.85	07.87					
	2.4 TD Intercooler	90		08.86	07.87					
	2.0	76		09.88	08.90	24.0122-0138.1	422138	+ 14" Rad ¹⁾	263 22,0 20,0 V	
	2.0	82		08.89	08.90	24.0122-0137.1	422137	+ 15" Rad ²⁾	287 22,0 20,0 V	
	2.0	86		08.87	08.88					
	2.0	89		08.87	08.90					
	2.3	83		08.87	12.89					
	2.3	84		08.87	07.90					
	2.3	85		08.87	08.90					
	2.3	96		08.87	07.88					
	2.3	100		08.89	07.90					
	2.3	111		07.89	08.90					
	2.3	114		08.88	07.90					
	2.3	117		08.87	07.89					
	2.3 T	115		08.87	07.89					
	2.3 T	121		08.89	07.90					
	2.3 T	134		08.87	07.88					
	2.3 T	140		08.89	07.90					
	2.4 D	60		08.87	07.88					
	2.4 TD	80		08.87	08.90					
	2.4 TD Intercooler	90		08.87	07.88					
	2.0	82		09.90	07.91 - ABS	24.0122-0137.1	422137		287 22,0 20,0 V	
	2.0	89		09.90	07.92 - ABS					
	2.3	85		09.90	07.92 - ABS					
	2.3	111		09.90	07.92 - ABS					
	2.4 TD	80		09.90	07.92 - ABS					
	2.0	82		09.90	07.91 + ABS	24.0126-0105.1	426105		280 26,0 23,0 V + B	
	2.0	89		09.90	07.92 + ABS					
	2.3	85		09.90	07.92 + ABS					
	2.3	111		09.90	07.92 + ABS					
	2.4 TD	80		09.90	07.92 + ABS					
	2.0	76		09.88	08.90	83.6134-0335.3	330277	4	L=335	
	2.0	82		08.89	08.90					
	2.0	86		01.87	08.88					
	2.0	89		08.85	07.92 - ABS					
	2.3	82		08.85	07.86					
	2.3	83		08.85	12.89					
	2.3	84		09.85	07.90					
	2.3	85		08.87	07.92 - ABS					
	2.3	96		08.85	07.88					
	2.3	100		08.89	07.90					
	2.3	111		07.89	07.92 - ABS					
	2.3	114		08.88	07.90					
	2.3	117		08.87	07.89					

¹⁾ + 14" wheel / + ruota 14" / + roue 14" / + rueda 14"

²⁾ + 15" wheel / + ruota 15" / + roue 15" / + rueda 15"



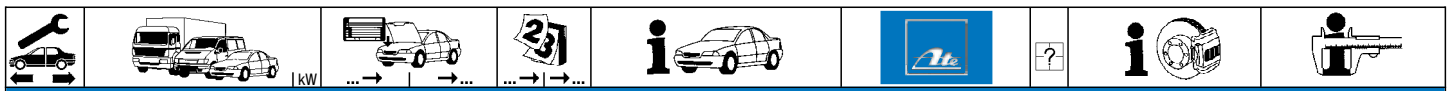

VOLVO 740 Kombi (85-92)











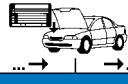

	2.3 T	115		08.86	07.89	83.6134-0335.3	330277	4		L=335							
	2.3 T	121		08.89	07.90												
	2.3 T	134		08.85	07.88												
	2.3 T	140		08.89	07.90												
	2.4 D	60		08.85	07.88												
	2.4 TD	80		09.85	07.92 - ABS												
	2.4 TD Intercooler	90		08.86	07.88												
	2.0	76		09.88	08.90 + ABS												
	2.0	82		08.89	07.91 + ABS												
	2.0	86		09.87	08.88 + ABS												
2.0	89		09.87	07.92 + ABS													
2.3	83		09.87	12.89 + ABS													
2.3	84		09.87	07.90 + ABS													
2.3	85		09.87	07.92 + ABS													
2.3	96		09.87	07.88 + ABS													
2.3	100		08.89	07.90 + ABS													
2.3	111		07.89	07.92 + ABS													
2.3	114		08.88	07.90 + ABS													
2.3	117		09.87	07.89 + ABS													
2.3 T	115		09.87	07.89 + ABS													
2.3 T	121		08.89	07.90 + ABS													
2.3 T	134		09.87	07.88 + ABS													
2.3 T	140		08.89	07.90 + ABS													
2.4 D	60		09.87	07.88 + ABS													
2.4 TD	80		09.87	07.92 + ABS													
2.4 TD Intercooler	90		09.87	07.88 + ABS													
	2.0	86		01.87	07.87	24.9236-0001.5	230005	<input type="checkbox"/>	für Vorg. 13.2381-0067/-0068.2 ¹⁾	D=36	ATE						
	2.0	89		08.85	07.87							24.9236-0002.5	230006	<input type="checkbox"/>	D=36	ATE	
	2.3	82		08.85	07.86							24.9238-0087.5	230035	<input type="checkbox"/>	D=38	ATE	
	2.3	83		08.85	07.87							24.9238-0088.5	230036	<input type="checkbox"/>	D=38	ATE	
	2.3	84		09.85	07.87							13.2401-0027.2	210045	<input type="checkbox"/>	D=40	ATE	
	2.3	96		08.85	07.87							13.2401-0028.2	210046	<input type="checkbox"/>	D=40	ATE	
	2.3 T	115		08.86	07.87							24.9240-0028.5	230018	<input type="checkbox"/>	D=40	ATE	
	2.3 T	134		08.85	07.87							13.0441-3815.2	250069	<input type="checkbox"/>	D=38	Dichtungssatz	ATE
	2.4 D	60		08.85	07.87							13.0441-3819.2	250072	<input type="checkbox"/>	D=38	Dichtungssatz	ATE
	2.4 TD	80		09.85	07.87							13.0441-4014.2	250079	<input type="checkbox"/>	für Vorg. 13.2401-0023/-0024.2 ²⁾	Dichtungssatz	ATE
2.4 TD Intercooler	90		08.86	07.87													
	2.0	76		09.88	08.90 + Starrachse ³⁾	24.9238-0087.5	230035	<input type="checkbox"/>	für Vorg. 13.2381-0067/-0068.2 ¹⁾	D=38	ATE						
	2.0	82		08.89	08.90 + Starrachse ³⁾							24.9238-0088.5	230036	<input type="checkbox"/>	D=38	ATE	
	2.0	82		09.90	07.91							13.2401-0027.2	210045	<input type="checkbox"/>	D=40	ATE	
	2.0	86		08.87	08.88 + Starrachse ³⁾							13.2401-0028.2	210046	<input type="checkbox"/>	D=40	ATE	
	2.0	89		08.87	08.90 + Starrachse ³⁾							24.9240-0028.5	230018	<input type="checkbox"/>	D=40	ATE	
	2.0	89		09.90	07.92							13.0441-3815.2	250069	<input type="checkbox"/>	D=38	Dichtungssatz	ATE
	2.3	83		08.87	12.89 + Starrachse ³⁾							13.0441-3819.2	250072	<input type="checkbox"/>	D=38	Dichtungssatz	ATE
	2.3	84		08.87	07.90 + Starrachse ³⁾							13.0441-4014.2	250079	<input type="checkbox"/>	für Vorg. 13.2401-0023/-0024.2 ²⁾	Dichtungssatz	ATE
	2.3	85		08.87	08.90 + Starrachse ³⁾												
	2.3	85		09.90	07.92												
2.3	96		08.87	07.88 + Starrachse ³⁾													
2.3	100		08.89	07.90 + Starrachse ³⁾													
2.3	111		07.89	08.90 + Starrachse ³⁾													
2.3	111		09.90	07.92													
2.3	114		08.88	07.90 + Starrachse ³⁾													
2.3	117		08.87	07.89 + Starrachse ³⁾													
2.3 T	115		08.87	07.89 + Starrachse ³⁾													
2.3 T	121		08.89	07.90 + Starrachse ³⁾													
2.3 T	134		08.87	07.88 + Starrachse ³⁾													
2.3 T	140		08.89	07.90 + Starrachse ³⁾													
2.4 D	60		08.87	07.88 + Starrachse ³⁾													
2.4 TD	80		08.87	08.90 + Starrachse ³⁾													
2.4 TD	80		09.90	07.92													
2.4 TD Intercooler	90		08.87	07.88 + Starrachse ³⁾													
	2.0	76		09.88	08.90 + Starrachse ³⁾	13.0460-3401.2	603401	<input type="checkbox"/>		20755 14,4	ATE						
	2.0	82		08.89	08.90 + Starrachse ³⁾							13.0460-0088.2	610088	<input type="checkbox"/>	Belagsatz-Zubehör	ATE	
	2.0	82		09.90	07.91												
	2.0	86		08.87	08.88 + Starrachse ³⁾												
	2.0	89		08.87	08.90 + Starrachse ³⁾												
	2.0	89		09.90	07.92												
	2.3	83		08.87	12.89 + Starrachse ³⁾												
	2.3	84		08.87	07.90 + Starrachse ³⁾												
	2.3	85		08.87	08.90 + Starrachse ³⁾												
	2.3	85		09.90	07.92												
2.3	96		08.87	07.88 + Starrachse ³⁾													
2.3	100		08.89	07.90 + Starrachse ³⁾													
2.3	111		07.89	08.90 + Starrachse ³⁾													
2.3	111		09.90	07.92													
2.3	114		08.88	07.90 + Starrachse ³⁾													
2.3	117		08.87	07.89 + Starrachse ³⁾													
2.3 T	115		08.87	07.89 + Starrachse ³⁾													
2.3 T	121		08.89	07.90 + Starrachse ³⁾													
2.3 T	134		08.87	07.88 + Starrachse ³⁾													
2.3 T	140		08.89	07.90 + Starrachse ³⁾													
2.4 D	60		08.87	07.88 + Starrachse ³⁾													
2.4 TD	80		08.87	08.90 + Starrachse ³⁾													
2.4 TD	80		09.90	07.92													
2.4 TD Intercooler	90		08.87	07.88 + Starrachse ³⁾													
	2.0	76		09.88	08.90 + Multi-Link-Achse ⁴⁾	13.0460-2935.2	602935	<input type="checkbox"/>		21385 13,8 / S	LUC						
	2.0	82		08.89	08.90 + Multi-Link-Achse ⁴⁾												

¹⁾ f.predec.13.2381-0067/-0068.2 / p.prece.13.2381-0067.2/-0068.2 / p.préd.13.2381-0067.2/-0068.2 / p.prede.13.2381-0067.2/-0068.2

²⁾ f.predec.13.2401-0023/-0024.2 / p.prece.13.2401-0023.2/-0024.2 / p.préd.13.2401-0023.2/-0024.2 / p.prede.13.2401-0023.2/-0024.2

³⁾ + rigid axle / + assale rigido / + essieu rigide / + eje rigido

⁴⁾ + multi link axle / + assale Multi-link / + essieu multi-link / + eje Multi-Link

VOLVO 740 Kombi (85-92)														
														
	2.0	86		09.87	08.88	+ Multi-Link-Achse ¹⁾	13.0460-2935.2	602935				21385	13,8 /S	LUC
	2.0	89		09.87	08.90	+ Multi-Link-Achse ¹⁾								
	2.3	83		09.87	12.89	+ Multi-Link-Achse ¹⁾								
	2.3	84		09.87	07.90	+ Multi-Link-Achse ¹⁾								
	2.3	85		09.87	08.90	+ Multi-Link-Achse ¹⁾								
	2.3	96		09.87	07.88	+ Multi-Link-Achse ¹⁾								
	2.3	100		08.89	07.90	+ Multi-Link-Achse ¹⁾								
	2.3	111		07.89	08.90	+ Multi-Link-Achse ¹⁾								
	2.3	114		08.88	07.90	+ Multi-Link-Achse ¹⁾								
	2.3	117		09.87	07.89	+ Multi-Link-Achse ¹⁾								
	2.3 T	115		09.87	07.89	+ Multi-Link-Achse ¹⁾								
	2.3 T	121		08.89	07.90	+ Multi-Link-Achse ¹⁾								
	2.3 T	134		09.87	07.88	+ Multi-Link-Achse ¹⁾								
	2.3 T	140		08.89	07.90	+ Multi-Link-Achse ¹⁾								
	2.4 D	60		09.87	07.88	+ Multi-Link-Achse ¹⁾								
	2.4 TD	80		09.87	08.90	+ Multi-Link-Achse ¹⁾								
	2.4 TD Intercooler	90		09.87	07.88	+ Multi-Link-Achse ¹⁾								
	2.0	76		09.88	08.90	+ Starrachse ²⁾	24.0110-0189.1	410189				281	9,6 8,4 +B	
	2.0	82		08.89	08.90	+ Starrachse ²⁾								
	2.0	82		09.90	07.91									
	2.0	86		08.87	08.88	+ Starrachse ²⁾								
	2.0	89		08.87	08.90	+ Starrachse ²⁾								
	2.0	89		09.90	07.92									
	2.3	83		08.87	12.89	+ Starrachse ²⁾								
	2.3	84		08.87	07.90	+ Starrachse ²⁾								
	2.3	85		08.87	08.90	+ Starrachse ²⁾								
	2.3	85		09.90	07.92									
	2.3	96		08.87	07.88	+ Starrachse ²⁾								
	2.3	100		08.89	07.90	+ Starrachse ²⁾								
	2.3	111		07.89	08.90	+ Starrachse ²⁾								
	2.3	111		09.90	07.92									
	2.3	114		08.88	07.90	+ Starrachse ²⁾								
	2.3	117		08.87	07.89	+ Starrachse ²⁾								
	2.3 T	115		08.87	07.89	+ Starrachse ²⁾								
	2.3 T	121		08.89	07.90	+ Starrachse ²⁾								
	2.3 T	134		08.87	07.88	+ Starrachse ²⁾								
	2.3 T	140		08.89	07.90	+ Starrachse ²⁾								
	2.4 D	60		08.87	07.88	+ Starrachse ²⁾								
	2.4 TD	80		08.87	08.90	+ Starrachse ²⁾								
	2.4 TD	80		09.90	07.92									
	2.4 TD Intercooler	90		08.87	07.88	+ Starrachse ²⁾								
	2.0	76		09.88	08.90	+ Multi-Link-Achse ¹⁾	24.0110-0206.1	410206				265	10,0 8,0	
	2.0	82		08.89	08.90	+ Multi-Link-Achse ¹⁾								
	2.0	86		09.87	08.88	+ Multi-Link-Achse ¹⁾								
	2.0	89		09.87	08.90	+ Multi-Link-Achse ¹⁾								
	2.3	83		09.87	12.89	+ Multi-Link-Achse ¹⁾								
	2.3	84		09.87	07.90	+ Multi-Link-Achse ¹⁾								
	2.3	85		09.87	08.90	+ Multi-Link-Achse ¹⁾								
	2.3	96		09.87	07.88	+ Multi-Link-Achse ¹⁾								
	2.3	100		08.89	07.90	+ Multi-Link-Achse ¹⁾								
	2.3	111		07.89	08.90	+ Multi-Link-Achse ¹⁾								
	2.3	114		08.88	07.90	+ Multi-Link-Achse ¹⁾								
	2.3	117		09.87	07.89	+ Multi-Link-Achse ¹⁾								
	2.3 T	115		09.87	07.89	+ Multi-Link-Achse ¹⁾								
	2.3 T	121		08.89	07.90	+ Multi-Link-Achse ¹⁾								
	2.3 T	134		09.87	07.88	+ Multi-Link-Achse ¹⁾								
	2.3 T	140		08.89	07.90	+ Multi-Link-Achse ¹⁾								
	2.4 D	60		09.87	07.88	+ Multi-Link-Achse ¹⁾								
	2.4 TD	80		09.87	08.90	+ Multi-Link-Achse ¹⁾								
	2.4 TD Intercooler	90		09.87	07.88	+ Multi-Link-Achse ¹⁾								
	2.0	76		09.88	08.90		83.6124-0305.3	330723	2			L=305		
	2.0	82		08.89	08.90									
	2.0	86		01.87	08.88									
	2.0	89		08.85	07.92									
	2.3	82		08.85	07.86									
	2.3	83		08.85	12.89									
	2.3	84		09.85	07.90									
	2.3	85		08.87	07.92									
	2.3	96		08.85	07.88									
	2.3	100		08.89	07.90									
	2.3	111		07.89	07.92									
	2.3	114		08.88	07.90									
	2.3	117		08.87	07.89									
	2.3 T	115		08.86	07.89									
	2.3 T	121		08.89	07.90									
	2.3 T	134		08.85	07.88									
	2.3 T	140		08.89	07.90									
	2.4 D	60		08.85	07.88									
	2.4 TD	80		09.85	07.92	- ABS								
	2.4 TD Intercooler	90		08.86	07.88									
	2.4 TD	80		09.85	07.92	+ ABS	83.6134-0300.3	330725	2			L=300		
	2.0	76		09.88	08.90	+ Starrachse ²⁾	03.0137-0169.2	650169				160 x 25		
	2.0	82		08.89	08.90	+ Starrachse ²⁾	03.0137-9065.2	669065				Bremsbacken-Zubehör		
	2.0	82		09.90	07.91									
	2.0	86		08.87	08.88	+ Starrachse ²⁾								
	2.0	89		08.87	08.90	+ Starrachse ²⁾								
	2.0	89		09.90	07.92									

¹⁾ + multi link axle / + assale Multi-link / + essieu multi-link / + eje Multi-Link
²⁾ + rigid axle / + assale rigido / + essieu rigide / + eje rigido

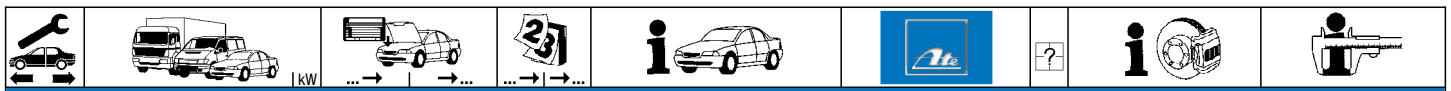















VOLVO 740 Kombi (85-92)

	2.3	83	08.87	12.89	+ Starrachse ¹⁾	03.0137-0169.2	650169		160 x 25 Bremsbacken-Zubehör
	2.3	84	08.87	07.90	+ Starrachse ¹⁾	03.0137-9065.2	669065		
	2.3	85	08.87	08.90	+ Starrachse ¹⁾				
	2.3	85	09.90	07.92					
	2.3	96	08.87	07.88	+ Starrachse ¹⁾				
	2.3	100	08.89	07.90	+ Starrachse ¹⁾				
	2.3	111	07.89	08.90	+ Starrachse ¹⁾				
	2.3	111	09.90	07.92					
	2.3	114	08.88	07.90	+ Starrachse ¹⁾				
	2.3	117	08.87	07.89	+ Starrachse ¹⁾				
	2.3 T	115	08.87	07.89	+ Starrachse ¹⁾				
	2.3 T	121	08.89	07.90	+ Starrachse ¹⁾				
	2.3 T	134	08.87	07.88	+ Starrachse ¹⁾				
	2.3 T	140	08.89	07.90	+ Starrachse ¹⁾				
	2.4 D	60	08.87	07.88	+ Starrachse ¹⁾				
	2.4 TD	80	08.87	08.90	+ Starrachse ¹⁾				
	2.4 TD	80	09.90	07.92					
2.4 TD Intercooler	90	08.87	07.88	+ Starrachse ¹⁾					
	2.0	76	09.88	08.90	+ Multi-Link-Achse ²⁾	03.0137-0299.2	650299		160 x 25 Bremsbacken-Zubehör
	2.0	82	08.89	08.90	+ Multi-Link-Achse ²⁾	03.0137-9199.2	669199		
	2.0	86	09.87	08.88	+ Multi-Link-Achse ²⁾				
	2.0	89	09.87	08.90	+ Multi-Link-Achse ²⁾				
	2.3	83	09.87	12.89	+ Multi-Link-Achse ²⁾				
	2.3	84	09.87	07.90	+ Multi-Link-Achse ²⁾				
	2.3	85	09.87	08.90	+ Multi-Link-Achse ²⁾				
	2.3	96	09.87	07.88	+ Multi-Link-Achse ²⁾				
	2.3	100	08.89	07.90	+ Multi-Link-Achse ²⁾				
	2.3	111	07.89	08.90	+ Multi-Link-Achse ²⁾				
	2.3	114	08.88	07.90	+ Multi-Link-Achse ²⁾				
	2.3	117	09.87	07.89	+ Multi-Link-Achse ²⁾				
	2.3 T	115	09.87	07.89	+ Multi-Link-Achse ²⁾				
	2.3 T	121	08.89	07.90	+ Multi-Link-Achse ²⁾				
	2.3 T	134	09.87	07.88	+ Multi-Link-Achse ²⁾				
	2.3 T	140	08.89	07.90	+ Multi-Link-Achse ²⁾				
	2.4 D	60	09.87	07.88	+ Multi-Link-Achse ²⁾				
2.4 TD	80	09.87	08.90	+ Multi-Link-Achse ²⁾					
2.4 TD Intercooler	90	09.87	07.88	+ Multi-Link-Achse ²⁾					
	2.0	86	01.87	07.87		24.3727-1306.2	581306	<input type="checkbox"/>	L=830
	2.0	89	08.85	07.87					
	2.3	82	08.85	07.86					
	2.3	83	08.85	07.87					
	2.3	84	09.85	07.87					
	2.3	96	08.85	07.87					
	2.3 T	115	08.86	07.87					
	2.3 T	134	08.85	07.87					
	2.4 D	60	08.85	07.87					
	2.4 TD	80	09.85	07.87					
2.4 TD Intercooler	90	08.86	07.87						
	2.0	89	09.91	07.92		03.6055-0431.3	320142		BR 5/35 (4) ATE
	2.0	86	01.87	07.87		24.2419-0928.3	030056		Gz 19,05
	2.0	89	08.85	07.87					
	2.3	82	08.85	07.86					
	2.3	83	08.85	07.87					
	2.3	84	09.85	07.87					
	2.3	96	08.85	07.87					
	2.3 T	115	08.86	07.87					
	2.3 T	134	08.85	07.87					
	2.4 D	60	08.85	07.87					
	2.4 TD	80	09.85	07.87					
2.4 TD Intercooler	90	08.86	07.87						
	2.0	76	09.88	08.90		24.2419-0941.3	030067		Gz 19,05
	2.0	82	08.89	07.91					
	2.0	86	08.87	08.88					
	2.0	89	08.87	07.92					
	2.3	83	08.87	12.89					
	2.3	84	08.87	07.90					
	2.3	85	08.87	07.92					
	2.3	96	08.87	07.88					
	2.3	100	08.89	07.90					
	2.3	111	07.89	07.92					
	2.3	114	08.88	07.90					
	2.3	117	08.87	07.89					
	2.3 T	115	08.87	07.89					
	2.3 T	121	08.89	07.90					
	2.3 T	134	08.87	07.88					
	2.3 T	140	08.89	07.90					
	2.4 D	60	08.87	07.88					
2.4 TD	80	08.87	07.92						
2.4 TD Intercooler	90	08.87	07.88						
	2.0	86	01.87	07.87		03.2522-0420.3	040086		Nz 22,20
	2.0	89	08.85	07.87					
	2.3	82	08.85	07.86					
	2.3	83	08.85	07.87					
	2.3	84	09.85	07.87					

¹⁾ + rigid axle / + assale rigido / + essieu rigide / + eje rígido
²⁾ + multi link axle / + assale Multi-link / + essieu multi-link / + eje Multi-Link



									
VOLVO 740 Kombi (85-92)									
	2.3	96		08.85	07.87	03.2522-0420.3	040086		Nz 22,20
	2.3 T	115		08.86	07.87				
	2.3 T	134		08.85	07.87				
	2.4 D	60		08.85	07.87				
	2.4 TD	80		09.85	07.87				
	2.4 TD Intercooler	90		08.86	07.87				
	2.0	76		09.88	08.90	24.2520-0905.3	040057		Nz 20,64
	2.0	82		08.89	07.91				
	2.0	86		08.87	08.88				
	2.0	89		08.87	07.92				
	2.3	83		08.87	12.89				
	2.3	84		08.87	07.90				
	2.3	85		08.87	07.92				
	2.3	96		08.87	07.88				
	2.3	100		08.89	07.90				
2.3	111		07.89	07.92					
2.3	114		08.88	07.90					
2.3	117		08.87	07.89					
2.3 T	115		08.87	07.89					
2.3 T	121		08.89	07.90					
2.3 T	134		08.87	07.88					
2.3 T	140		08.89	07.90					
2.4 D	60		08.87	07.88					
2.4 TD	80		08.87	07.92					
2.4 TD Intercooler	90		08.87	07.88					
	2.4 D	60		08.87	07.88	24.3728-1301.2	591301		L=1100
	2.4 TD	80		08.87	08.90				
	2.4 TD Intercooler	90		08.87	07.88				
VOLVO 760 Limousine (82-92)									
	2.3	84		08.84	08.87 + ABS	03.2023-0164.3	010014		THz 23,81/19,05 + B. ATE
	2.3	119		01.88	07.92				
	2.3 T	134		09.85	10.88 + ABS				
	2.4 D	60		09.85	07.92 + ABS				
	2.4 TD	80		04.85	07.92 + ABS				
	2.4 TD	82		09.85	07.87 + ABS				
	2.4 TD Intercooler	85		08.87	07.92				
	2.8	95		09.85	12.87 + ABS				
	2.8	105		05.86	08.91 + ABS				
	2.8	108		08.86	07.90 + ABS				
	2.8	115		09.85	07.88 + ABS				
2.8	125		09.87	08.90 + ABS					
	2.3	84		08.84	08.87 - ABS	24.0101-3401.2	260043		Bremssattel-Zubehör LUC
	2.3 T	134		09.84	08.87 - ABS				
	2.4 D	60		09.84	08.87 - ABS				
	2.4 TD	80		04.87	08.87 - ABS				
	2.4 TD	82		09.84	07.87 - ABS				
	2.8	95		09.84	08.87 - ABS				
	2.8	105		05.86	08.87 - ABS				
	2.8	108		08.86	08.87 - ABS				
2.8	115		09.84	08.87 - ABS					
	2.3 T	127		08.82	07.84	13.0460-2943.2	602943		21266 17,0 /S LUC
	2.4 D	60		01.82	08.84				
	2.4 TD	82		08.82	08.84				
	2.8	95		01.82	08.84				
	2.8	115		08.81	08.84				
	2.3	84		08.84	08.87	13.0460-3914.2	603914		21233 16,7 BDX
	2.3	119		08.84	08.87	13.0460-2943.2	602943		21266 17,0 /S LUC
	2.3	119		01.88	07.92	13.0460-0429.2	610429		Belagsatz-Zubehör BDX
	2.3 T	134		09.84	10.88				
	2.4 D	60		09.84	07.92				
2.4 TD	80		04.87	07.92					
2.4 TD	82		09.84	07.87					
2.4 TD Intercooler	85		08.87	07.92					
2.8	95		09.84	12.87					
2.8	105		05.86	08.91					
2.8	108		08.86	07.90					
2.8	115		09.84	07.88					
2.8	125		09.87	08.90					
	2.3 T	127		08.82	08.87	24.0122-0217.2	422217	+ 14" Rad ¹⁾	263 22,0 20,0 V
	2.3 T	134		09.84	08.87				
	2.4 D	60		09.84	08.87				
	2.4 TD	80		04.87	08.87				
	2.4 TD	82		09.84	07.87				
	2.8	95		09.84	08.87				
	2.8	105		05.86	08.87				
	2.8	108		08.86	08.87				
	2.8	115		09.84	08.87				
	2.3	84		08.84	08.87	24.0122-0137.1	422137		287 22,0 20,0 V
	2.3	119		01.88	07.92				
	2.3 T	134		09.87	10.88				
2.4 D	60		09.87	07.92					
2.4 TD	80		09.87	07.92					
2.4 TD Intercooler	85		08.87	07.92					
2.8	95		09.87	12.87					
2.8	105		09.87	08.91					

¹⁾ + 14" wheel / + ruota 14" / + roue 14" / + rueda 14"



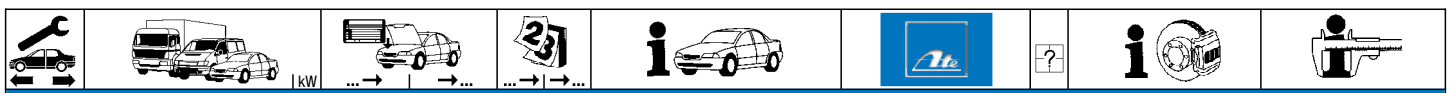

VOLVO 760 Limousine (82-92)

	2.8	108		09.87	07.90		24.0122-0137.1	422137			287 22,0 20,0 V	
	2.8	115		09.87	07.88							
	2.8	125		09.87	08.90							
	2.3 T	127		08.82	07.84	- ABS	83.6134-0335.3	330277	4		L=335	
	2.3 T	134		08.84	08.87	- ABS						
	2.4 D	60		01.82	08.87	- ABS						
	2.4 TD	80		04.87	08.87	- ABS						
	2.4 TD	82		08.82	07.87	- ABS						
	2.8	95		01.82	08.87	- ABS						
	2.8	105		05.86	08.87	- ABS						
	2.8	108		08.86	08.87	- ABS						
	2.8	115		08.81	08.87	- ABS						
	2.3 T	127		09.82	07.84	+ ABS	83.6124-0305.3	330723	2		L=305	
	2.3 T	134		09.85	08.87	+ ABS						
	2.4 D	60		09.85	08.87	+ ABS						
	2.4 TD	80		04.87	08.87	+ ABS						
	2.4 TD	82		09.85	07.87	+ ABS						
	2.8	95		09.85	08.87	+ ABS						
	2.8	105		05.86	08.87	+ ABS						
	2.8	108		08.86	08.87	+ ABS						
	2.8	115		09.85	08.87	+ ABS						
	2.3	84		08.84	08.87		83.6134-0335.3	330277	2		L=335	
	2.3	119		01.88	07.92							
	2.3 T	134		09.87	10.88							
	2.4 D	60		09.87	07.92							
	2.4 TD	80		09.87	07.92							
	2.4 TD Intercooler	85		08.87	07.92							
	2.8	95		09.87	12.87							
	2.8	105		09.87	08.91							
	2.8	108		09.87	07.90							
	2.8	115		09.87	07.88							
	2.8	125		09.87	08.90							
	2.3 T	134		09.84	08.87		24.9236-0001.5	230005			D=36	ATE
	2.4 D	60		09.84	08.87		24.9236-0002.5	230006			D=36	ATE
	2.4 TD	80		04.87	08.87		24.9238-0087.5	230035			D=38	ATE
	2.4 TD	82		09.84	07.87		24.9238-0088.5	230036			D=38	ATE
	2.8	95		09.84	08.87		13.2401-0027.2	210045			D=40	ATE
	2.8	105		05.86	08.87		13.2401-0028.2	210046			D=40	ATE
	2.8	108		08.86	08.87		24.9240-0028.5	230018			D=40	ATE
	2.8	115		09.84	08.87		13.0441-3815.2	250069			D=40	ATE
							13.0441-3819.2	250072		für Vorg. 13.2381-0067/-0068.2 ¹⁾	Dichtungssatz	ATE
							13.0441-4014.2	250079		D=38	Dichtungssatz	ATE
										für Vorg. 13.2401-0023/-0024.2 ²⁾	Dichtungssatz	ATE
	2.3 T	127		08.82	07.84		13.0460-3401.2	603401			20755 14,4	ATE
	2.3 T	134		08.84	08.87		13.0460-0088.2	610088			Belagsatz-Zubehör	ATE
	2.4 D	60		01.82	08.87							
	2.4 TD	80		04.87	08.87							
	2.4 TD	82		08.82	07.87							
	2.8	95		01.82	08.87							
	2.8	105		05.86	08.87							
	2.8	108		08.86	08.87							
	2.8	115		08.81	08.87							
	2.3	84		08.84	08.87		13.0460-2935.2	602935			21385 13,8 /S	LUC
	2.3	119		01.88	07.92							
	2.3 T	134		09.87	10.88							
	2.4 D	60		09.87	07.92							
	2.4 TD	80		09.87	07.92							
	2.4 TD Intercooler	85		08.87	07.92							
	2.8	95		09.87	12.87							
	2.8	105		09.87	08.91							
	2.8	108		09.87	07.90							
	2.8	115		09.87	07.88							
	2.8	125		09.87	08.90							
	2.3	84		08.84	08.87		24.0110-0189.1	410189			281 9,6 8,4 +B	
	2.3 T	127		08.82	07.84							
	2.3 T	134		08.84	08.87							
	2.4 D	60		01.82	08.87							
	2.4 TD	80		04.87	08.87							
	2.4 TD	82		08.82	07.87							
	2.8	95		01.82	08.87							
	2.8	105		05.86	08.87							
	2.8	108		08.86	08.87							
	2.8	115		08.81	08.87							
	2.3	119		08.84	08.87		24.0110-0206.1	410206			265 10,0 8,0	
	2.3	119		01.88	07.92							
	2.3 T	134		09.87	10.88							
	2.4 D	60		09.87	07.92							
	2.4 TD	80		09.87	07.92							
	2.4 TD Intercooler	85		08.87	07.92							
	2.8	95		09.87	12.87							
	2.8	105		09.87	08.91							
	2.8	108		09.87	07.90							
	2.8	115		09.87	07.88							
	2.8	125		09.87	08.90							

¹⁾ f.predec.13.2381-0067/-0068.2 / p.prece.13.2381-0067.2/-0068.2 / p.préd.13.2381-0067.2/-0068.2 / p.prede.13.2381-0067.2/-0068.2

²⁾ f.predec.13.2401-0023/-0024.2 / p.prece.13.2401-0023.2/-0024.2 / p.préd.13.2401-0023.2/-0024.2 / p.prede.13.2401-0023.2/-0024.2

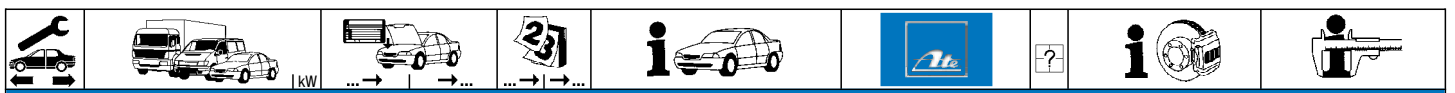





































VOLVO 760 Limousine (82-92)

	2.3 T 127		08.82	07.84	83.6124-0305.3	330723	2		L=305
	2.3 T 134		08.84	08.87					
	2.4 D 60		01.82	08.87					
	2.4 TD 80		04.87	08.87					
	2.4 TD 82		08.82	07.87					
	2.8 95		01.82	08.87					
	2.8 105		05.86	08.87					
	2.8 108		08.86	08.87					
	2.8 115		08.81	08.87					
	2.3 84		08.84	08.87					
	2.3 119		01.88	07.92	83.6134-0300.3	330725	2		L=300
	2.3 T 134		09.87	10.88					
	2.4 D 60		09.87	07.92					
	2.4 TD 80		09.87	07.92					
	2.4 TD Intercooler 85		08.87	07.92					
	2.8 95		09.87	12.87					
	2.8 105		09.87	08.91					
	2.8 108		09.87	07.90					
	2.8 115		09.87	07.88					
	2.8 125		09.87	08.90					
	2.3 T 127		08.82	07.84	03.0137-0169.2	650169			160 x 25 Bremsbacken-Zubehör
	2.3 T 134		08.84	08.87					
	2.4 D 60		01.82	08.87					
	2.4 TD 80		04.87	08.87					
	2.4 TD 82		08.82	07.87					
	2.8 95		01.82	08.87					
	2.8 105		05.86	08.87					
	2.8 108		08.86	08.87					
	2.8 115		08.81	08.87					
	2.3 84		08.84	08.87					
	2.3 119		01.88	07.92	03.0137-0299.2	650299			160 x 25 Bremsbacken-Zubehör
	2.3 T 134		09.87	10.88					
	2.4 D 60		09.87	07.92					
	2.4 TD 80		09.87	07.92					
	2.4 TD Intercooler 85		08.87	07.92					
	2.8 95		09.87	12.87					
	2.8 105		09.87	08.91					
	2.8 108		09.87	07.90					
	2.8 115		09.87	07.88					
	2.8 125		09.87	08.90					
	2.3 T 127		08.82	07.84	24.3727-1306.2	581306	<input type="checkbox"/>		L=830
	2.3 T 134		08.84	08.87					
	2.4 D 60		01.82	08.87					
	2.4 TD 80		04.87	08.87					
	2.4 TD 82		08.82	07.87					
	2.8 95		01.82	08.87					
	2.8 105		05.86	08.87					
	2.8 108		08.86	08.87					
	2.8 115		08.81	08.87					
	2.3 T 134		09.85	10.88					
	2.4 TD 80		04.87	07.92					
	2.4 TD 82		09.85	07.87					
	2.4 TD Intercooler 85		08.87	07.92					
	2.8 95		01.82	12.87					
	2.8 105		05.86	08.91					
	2.8 108		08.86	07.90					
	2.8 115		08.81	07.88					
	2.8 125		09.87	08.90					
	2.3 T 134		09.85	10.88	03.2522-0420.3	040086			Nz 22,20
	2.4 TD 80		04.87	07.92					
	2.4 TD 82		09.85	07.87					
	2.4 TD Intercooler 85		08.87	07.92					
	2.4 TD 80		04.87	07.92	24.3728-1301.2	591301			L=1100
	2.4 TD 82		09.85	07.87					
	2.4 TD Intercooler 85		08.87	07.92					

VOLVO 760 Kombi (82-92)



















	2.3 84		08.84	08.87 + ABS	03.2023-0164.3	010014			Thz 23,81/19,05 + B. ATE
	2.3 T 134		09.85	08.90 + ABS					
	2.4 D 60		09.85	07.92 + ABS					
	2.4 TD Intercooler 85		08.87	07.92					
	2.8 95		05.86	12.87 + ABS					
	2.8 105		05.86	08.91 + ABS					
	2.8 115		08.86	08.90 + ABS					
	2.3 84		08.84	08.87 - ABS	24.0101-3401.2	260043			Bremsattel-Zubehör LUC
	2.3 T 134		08.84	08.87 - ABS					
	2.4 D 60		09.84	08.87 - ABS					
	2.8 95		05.86	08.87 - ABS					
	2.8 105		05.86	08.87 - ABS					
	2.8 115		08.86	08.87 - ABS					
	2.4 D 60		01.82	08.84	13.0460-2943.2	602943			21266 17,0 /S LUC

























												
VOLVO 760 Kombi (82-92)												
	2.3 2.3 T 2.4 D 2.4 TD Intercooler 2.8 2.8 2.8	84 134 60 85 95 105 115		08.84 09.85 09.84 08.87 05.86 05.86 08.86	08.87 08.90 07.92 07.92 12.87 08.91 08.90	13.0460-3914.2 13.0460-2943.2 13.0460-0429.2	603914 602943 610429	21233 16,7 21266 17,0 /S Belagsatz-Zubehör	BDX LUC BDX			
	2.3 2.3 T 2.4 D 2.8 2.8 2.8	84 134 60 95 105 115		08.84 08.84 09.84 05.86 05.86 08.86	08.87 08.87 08.87 08.87 08.87 08.87	24.0122-0217.2	422217	+ 14" Rad ¹⁾	263 22,0 20,0 V			
	2.3 T 2.4 D 2.4 TD Intercooler 2.8 2.8 2.8	134 60 85 95 105 115		09.87 09.87 08.87 09.87 09.87 09.87	08.90 07.92 07.92 12.87 08.91 08.90	24.0122-0137.1	422137		287 22,0 20,0 V			
	2.3 2.3 T 2.4 D 2.8 2.8 2.8	84 134 60 95 105 115		08.84 08.84 01.82 05.86 05.86 08.86	08.87 08.87 08.87 08.87 08.87 08.87	- ABS - ABS - ABS - ABS - ABS - ABS	83.6134-0335.3	330277	4	L=335		
	2.3 2.3 T 2.4 D 2.8 2.8 2.8	84 134 60 95 105 115		08.84 09.85 09.85 05.86 05.86 08.86	08.87 + ABS + ABS + ABS + ABS + ABS	+ ABS + ABS + ABS + ABS + ABS	83.6124-0305.3	330723	2	L=305		
	2.3 T 2.4 D 2.4 TD Intercooler 2.8 2.8 2.8	134 60 85 95 105 115		09.87 09.87 08.87 09.87 09.87 09.87	08.90 07.92 07.92 12.87 08.91 08.90		83.6134-0335.3	330277	2	L=335		
	2.3 2.3 T 2.4 D 2.8 2.8 2.8 2.8	84 134 60 95 105 115		08.84 08.84 09.84 05.86 05.86 08.86	08.87 08.87 08.87 08.87 08.87 08.87		24.9236-0001.5 24.9236-0002.5 24.9238-0087.5 24.9238-0088.5 13.2401-0027.2 13.2401-0028.2 24.9240-0028.5 13.0441-3815.2 13.0441-3819.2 13.0441-4014.2	230005 230006 230035 230036 210045 210046 230018 250069 250072 250079	      	für Vorg. 13.2381-0067/-0068.2 ²⁾ D=38 für Vorg. 13.2401-0023/-0024.2 ³⁾	D=36 D=36 D=38 D=38 D=40 D=40 D=40 Dichtungssatz Dichtungssatz Dichtungssatz	ATE ATE ATE ATE ATE ATE ATE ATE ATE ATE
	2.3 T 2.4 D 2.4 TD Intercooler 2.8 2.8 2.8	134 60 85 95 105 115		09.87 09.87 08.87 09.87 09.87 09.87	08.90 07.92 07.92 12.87 08.91 08.90		24.9238-0087.5 24.9238-0088.5 13.2401-0027.2 13.2401-0028.2 24.9240-0028.5 13.0441-3815.2 13.0441-3819.2 13.0441-4014.2	230035 230036 210045 210046 230018 250069 250072 250079	      	für Vorg. 13.2381-0067/-0068.2 ²⁾ D=38 für Vorg. 13.2401-0023/-0024.2 ³⁾	D=38 D=38 D=40 D=40 D=40 Dichtungssatz Dichtungssatz Dichtungssatz	ATE ATE ATE ATE ATE ATE ATE ATE
	2.3 2.3 T 2.4 D 2.8 2.8 2.8	84 134 60 95 105 115		08.84 08.84 01.82 05.86 05.86 08.86	08.87 08.87 07.87 08.87 08.87 08.87		13.0460-3401.2 13.0460-0088.2	603401 610088		20755 14,4 Belagsatz-Zubehör	ATE ATE	
	2.3 T 2.4 D 2.4 TD Intercooler 2.8 2.8 2.8	134 60 85 95 105 115		09.87 09.87 08.87 09.87 09.87 09.87	08.90 07.92 07.92 12.87 08.91 08.90		13.0460-2935.2	602935		21385 13,8 /S	LUC	
	2.3 2.3 T 2.4 D 2.8 2.8 2.8	84 134 60 95 105 115		08.84 08.84 01.82 05.86 05.86 08.86	08.87 08.87 08.87 08.87 08.87 08.87		24.0110-0189.1	410189		281 9,6 8,4 +B		
	2.3 T 2.4 D 2.4 TD Intercooler 2.8 2.8 2.8	134 60 85 95 105 115		09.87 09.87 08.87 09.87 09.87 09.87	08.90 07.92 07.92 12.87 08.91 08.90		24.0110-0206.1	410206		265 10,0 8,0		
	2.3 2.3 T 2.4 D 2.4 TD Intercooler 2.8 2.8 2.8	84 134 60 85 95 105 115		08.84 08.84 01.82 08.87 05.86 05.86 08.86	08.87 08.90 07.92 07.92 12.87 08.91 08.90		83.6124-0305.3	330723	2	L=305		

¹⁾ + 14" wheel / + ruota 14" / + roue 14" / + rueda 14"
²⁾ f.predec.13.2381-0067/-0068.2 / p.prece.13.2381-0067.2/-0068.2 / p.préd.13.2381-0067.2/-0068.2 / p.prede.13.2381-0067.2/-0068.2
³⁾ f.predec.13.2401-0023/-0024.2 / p.prece.13.2401-0023.2/-0024.2 / p.préd.13.2401-0023.2/-0024.2 / p.prede.13.2401-0023.2/-0024.2





















									
VOLVO 760 Kombi (82-92)									
	2.3 2.3 T 2.4 D 2.4 TD Intercooler 2.8 2.8 2.8	84 134 60 85 95 105 115		08.84 08.84 01.82 08.87 05.86 05.86 08.86	08.87 08.90 07.92 07.92 12.87 08.91 08.90	03.0137-0169.2 03.0137-9065.2	650169 669065	160 x 25 Bremsbacken-Zubehör	
	2.3 2.3 T 2.4 D 2.4 TD Intercooler 2.8 2.8 2.8	84 134 60 85 95 105 115	022134 022134 022134 022134 022134 022134	08.84 08.84 01.82 08.87 05.86 05.86 08.86	12.87	24.3727-1306.2	581306	L=830	
	2.3 T 2.4 TD Intercooler 2.8 2.8 2.8	134 85 95 105 115		09.85 08.87 05.86 05.86 08.86	08.90 07.92 08.87 08.87	24.2419-0928.3	030056	Gz 19,05	
	2.3 T 2.4 TD Intercooler	134 85		08.84 08.87	08.90 07.92	03.2522-0420.3	040086	Nz 22,20	
VOLVO 850 Limousine (91-96)									
	2.0 2.0 2.0 T 2.3 T5 2.3 T5 R 2.5 2.5 2.5 TDI	93 105 155 166 184 106 125 103		09.95 09.95 09.95 09.95 09.95 09.95 09.95 09.95	12.96 12.96 12.96 07.96 12.96 12.96 12.96 12.96	03.7760-3602.4	300176	10" ATE	
	2.0 2.0 2.0 T 2.3 T5 2.3 T5 R 2.5 2.5 2.5 2.5 TDI	93 105 155 166 184 103 106 125 103		08.94 06.91 08.93 08.93 08.95 06.91 08.94 08.91 08.95	08.95 08.95 08.95 08.95 08.95 07.94 08.95 08.95 08.95	10.6123-0445.3	010957	THz 23,81 - Behälter ATE	
	2.0 2.0 2.0 T 2.3 T5 2.3 T5 R 2.5 2.5 2.5 TDI	93 105 155 166 184 106 125 103		09.95 09.95 09.95 09.95 09.95 09.95 09.95 09.95	12.96 12.96 12.96 07.96 12.96 12.96 12.96 12.96	03.2023-1084.3 03.2023-1044.3	010591 010590	- ASR + ASR THz 23,81/20,64 THz 23,81/20,64	ATE ATE
	2.0 2.0 2.0 T 2.3 T5 2.3 T5 R 2.5 2.5 2.5 2.5 TDI	93 105 155 166 184 103 106 125 103		08.94 06.91 08.93 08.93 08.95 06.91 08.94 08.91 08.95	12.96 12.96 12.96 07.96 12.96 07.94 12.96 12.96 12.96	11.9571-9971.2 11.9571-9972.2 11.0441-5702.2 11.0101-5407.2 11.8171-0008.1 11.8116-0073.1	220605 220606 250033 260011 990049 390498	D=57, - Halter D=57, - Halter Dichtungssatz Hülzensatz Führungsbolzen Haltefeder	ATE ATE ATE ATE ATE
	2.0 2.0 2.0 T 2.5 2.5 2.5 2.5 TDI	93 105 155 103 106 125 103		08.94 06.91 08.93 06.91 08.94 08.91 08.95	12.96 12.96 12.96 07.94 12.96 12.96 12.96	13.0460-7053.2 13.0470-7053.2	607053 LD7053	21273 19,5 +/-WE 21273 19,5 +/-WE	ATE ATE
	2.3 T5 2.3 T5 R	166 184		08.93 08.95	07.96 12.96	13.0460-7053.2	607053	21273 19,5 +/-WE	ATE
	2.0 2.0 2.0 T 2.3 T5 2.3 T5 R 2.5 2.5 2.5 2.5 TDI	93 105 155 166 184 103 106 125 103		08.94 06.91 08.93 08.93 08.95 09.93 08.94 09.93 08.95	12.96 12.96 12.96 07.96 12.96 07.94 12.96 12.96 12.96	24.0126-0102.1	426102	280 26,0 23,0 V +B	
	2.5 2.5	103 125		06.91 08.91	08.93 08.93	24.0126-0101.1	426101	280 26,0 23,0 V +B	
	2.0 2.0 2.0 T 2.3 T5 2.3 T5 R 2.5 2.5	93 105 155 166 184 103 106		08.94 06.91 08.93 08.93 08.95 06.91 08.94	12.96 12.96 12.96 07.96 12.96 07.94 12.96	83.6134-0335.3	330277	L=335	





























										
VOLVO 850 Limousine (91-96)										
	2.5 2.5 TDI	125 103		08.91 08.95	12.96 12.96		83.6134-0335.3 330277	2	L=335	
	2.0 2.0 T 2.3 T5 2.3 T5 R 2.5 2.5 2.5 2.5 TDI	93 105 155 166 184 103 106 125 103		08.94 06.91 08.93 08.93 08.95 06.91 08.94 06.91 08.95	12.96 12.96 12.96 07.96 12.96 07.94 12.96 12.96 12.96		24.0711-1146.1 360060	2	Radsensor	
	2.0 2.0 2.0 T 2.3 T5 2.5 2.5 2.5 2.5 TDI 2.3 T5 R	93 105 155 166 103 106 125 103 184		08.94 06.91 08.93 08.93 06.91 08.94 08.91 08.95 08.95	12.96 12.96 12.96 07.96 12.96 07.94 12.96 12.96 12.96		13.2381-0097.2 210239 13.2381-0098.2 210240 24.9238-0097.5 230037 24.9238-0098.5 230038 13.0441-3815.2 250069 13.0441-3819.2 250072	   für Vorg. 13.2381-0065/-0066.2 ¹⁾	D=38 D=38 D=38 D=38 Dichtungssatz Dichtungssatz	ATE ATE ATE ATE ATE ATE
	2.0 2.0 2.0 T 2.3 T5 2.3 T5 R 2.5 2.5 2.5 2.5 TDI	93 105 155 166 184 103 106 125 103		08.94 06.91 08.93 08.93 08.95 06.91 08.94 08.91 08.95	12.96 12.96 12.96 07.96 12.96 07.94 12.96 12.96 12.96		13.0460-3403.2 603403 13.0460-0088.2 610088		20755 14,4 /Zub Belagsatz-Zubehör	ATE ATE
	2.0 2.0 2.0 T 2.3 T5 2.3 T5 R 2.5 2.5 2.5 2.5 TDI	93 105 155 166 184 103 106 125 103		08.94 06.91 08.93 08.93 08.95 09.93 08.94 09.93 08.95	12.96 12.96 12.96 07.96 12.96 07.94 12.96 12.96 12.96		24.0110-0214.1 410214		295 9,6 8,4 +B	
	2.5 2.5	103 125		06.91 08.91	08.93 08.93		24.0110-0216.1 410216		295 9,6 8,4	
	2.0 2.0 2.0 T 2.3 T5 2.3 T5 R 2.5 2.5 2.5 2.5 TDI	93 105 155 166 184 103 106 125 103		08.94 06.91 08.93 08.93 08.95 06.91 08.94 08.91 08.95	12.96 12.96 12.96 07.96 12.96 07.94 12.96 12.96 12.96		24.5201-0204.3 331400	2	L=204	
	2.0 2.0 2.0 T 2.3 T5 2.3 T5 R 2.5 2.5 2.5 2.5 TDI	93 105 155 166 184 103 106 125 103		08.94 06.91 08.93 08.93 08.95 09.93 08.94 09.93 08.95	12.96 12.96 12.96 07.96 12.96 07.94 12.96 12.96 12.96		24.0741-1105.1 360195	1	Radsensor L=1220/1840	
	2.5 2.5	103 125		06.91 08.91	08.93 08.93		24.0721-1113.1 360193	2	Radsensor	
	2.0 2.0 2.0 T 2.3 T5 2.3 T5 R 2.5 2.5 2.5 2.5 TDI	93 105 155 166 184 103 106 125 103		08.94 06.91 08.93 08.93 08.95 06.91 08.94 08.91 08.95	12.96 12.96 12.96 07.96 12.96 07.94 12.96 12.96 12.96		03.0137-0260.2 650260 03.0137-9176.2 669176		178 x 25 Bremsbacken-Zubehör	
	2.0 2.0 2.0 T 2.3 T5 2.3 T5 R 2.5 2.5 2.5 2.5 TDI	93 105 155 166 184 103 106 125 103		08.94 06.91 08.93 08.93 08.95 08.94 08.94 08.91 08.95	12.96 12.96 12.96 12.96 04.96 07.94 12.96 12.96 12.96		24.3727-1308.2 581308	2	L=1670	
	2.5 2.5	103 106		08.94 08.94	07.94 12.96					
	2.5 2.5	125 103	047066 047066							
	2.0 2.0 2.0 T 2.3 T5 2.3 T5 R	93 105 155 166 184		08.94 06.91 08.93 08.93 08.95	08.95 08.95 08.95 08.95 08.95		03.6055-0430.3 320065		BR 5/25 (4)	ATE

¹⁾ f.predec.13.2381-0065/-0066.2 / p.prece.13.2381-0065.2/-0066.2 / p.préd.13.2381-0065.2/-0066.2 / p.prede.13.2381-0065.2/-0066.2



								
VOLVO 850 Limousine (91-96)								
	2.5	103	06.91	07.94	03.6055-0430.3	320065		BR 5/25 (4) ATE
	2.5	106	08.94	08.95				
	2.5	125	08.91	08.95				
	2.5 TDI	103	08.95	08.95				
	2.0	93	08.94	12.96	24.2419-0939.3	030065		Gz 19,05
	2.0	105	06.91	12.96				
	2.0 T	155	08.93	12.96				
	2.3 T5	166	08.93	07.96				
	2.3 T5 R	184	08.95	12.96				
	2.5	103	06.91	07.94				
	2.5	106	08.94	12.96				
	2.5	125	08.91	12.96				
	2.5 TDI	103	08.95	12.96				
	2.0	93	08.94	12.96	24.2522-0907.3	040043		Nz 22,20
	2.0	105	06.91	12.96				
	2.0 T	155	08.93	12.96				
	2.3 T5	166	08.93	07.96				
	2.5	103	06.91	07.94				
	2.5	106	08.94	12.96				
	2.5	125	08.91	12.96				
	2.5 TDI	103	08.95	12.96				
VOLVO 850 Kombi (92-96)								
	2.0	93	09.95	12.96	03.7760-3602.4	300176		10" ATE
	2.0	105	09.95	12.96				
	2.0 T	155	09.95	12.95				
	2.3 T5	166	09.95	12.96				
	2.3 T5 R	184	09.95	12.96				
	2.5	106	09.95	12.96				
	2.5	125	09.85	12.96				
	2.5 AWD	142	04.96	12.96				
	2.5 TDI	103	09.95	12.96				
	2.0	93	08.94	08.95	10.6123-0445.3	010957		THz 23,81 - Behälter ATE
	2.0	105	02.93	08.95				
	2.0 T	155	02.93	08.95				
	2.3 T5	166	02.93	08.95				
	2.3 T5 R	184	08.95	08.95				
	2.5	103	08.92	07.94				
	2.5	106	08.94	08.95				
	2.5	125	09.92	08.95				
	2.5 TDI	103	08.95	08.95				
	2.0	93	09.95	12.96	03.2023-1084.3	010591	- ASR	THz 23,81/20,64 ATE
	2.0	105	09.95	12.96	03.2023-1044.3	010590	+ ASR	THz 23,81/20,64 ATE
	2.0 T	155	09.95	12.96				
	2.3 T5	166	09.95	12.96				
	2.3 T5 R	184	09.95	12.96				
	2.5	106	09.95	12.96				
	2.5 AWD	142	04.96	12.96				
	2.5 TDI	103	09.95	12.96				
	2.0	93	08.94	12.96	11.9571-9971.2	220605	<input type="checkbox"/>	D=57, - Halter ATE
	2.0	105	02.93	12.96	11.9571-9972.2	220606	<input type="checkbox"/>	D=57, - Halter ATE
	2.0 T	155	02.93	12.96	11.0441-5702.2	250033		Dichtungssatz ATE
	2.3 T5	166	02.93	12.96	11.0101-5407.2	260011		Hülensatz ATE
	2.3 T5 R	184	08.95	12.96	11.8171-0008.1	990049		Führungsbolzen ATE
	2.5	103	08.92	07.94	11.8116-0073.1	390498	2 <input type="checkbox"/>	Haltefeder ATE
	2.5	106	08.94	12.96				
	2.5	125	09.92	12.96				
	2.5 AWD	142	04.96	12.96				
	2.5 TDI	103	08.95	12.96				
	2.0	93	08.94	12.96	13.0460-7053.2	607053		21273 19,5 +/WE ATE
	2.0	105	02.93	12.96	13.0470-7053.2	LD7053		21273 19,5 +/WE ATE
	2.0 T	155	02.93	12.96				
	2.5	103	08.92	07.94				
	2.5	106	08.94	12.96				
	2.5	125	09.92	12.96				
	2.5 AWD	142	04.96	12.96				
	2.5 TDI	103	08.95	12.96				
	2.3 T5	166	02.93	12.96	13.0460-7053.2	607053		21273 19,5 +/WE ATE
	2.3 T5 R	184	08.95	12.96				
	2.0	93	08.94	12.96	24.0126-0102.1	426102		280 26,0 23,0 V +B
	2.0	105	02.93	12.96				
	2.0 T	155	02.93	12.96				
	2.3 T5	166	02.93	12.96				
	2.3 T5 R	184	08.95	12.96				
	2.5	103	09.93	07.94				
	2.5	106	08.94	12.96				
	2.5	125	08.93	12.96				
	2.5 AWD	142	04.96	12.96				
	2.5 TDI	103	08.95	12.96				
	2.5	103	08.92	08.93	24.0126-0101.1	426101		280 26,0 23,0 V +B
	2.5	125	09.92	08.93				
	2.0	93	08.94	12.96	83.6134-0335.3	330277	2	L=335
	2.0	105	02.93	12.96				
	2.0 T	155	02.93	12.96				
	2.3 T5	166	02.93	12.96				
	2.3 T5 R	184	08.95	12.96				

								
VOLVO 850 Kombi (92-96)								
	2.5	103	08.92	07.94	83.6134-0335.3	330277	2	L=335
	2.5	106	08.94	12.96				
	2.5	125	09.92	12.96				
	2.5 AWD	142	04.96	12.96				
	2.5 TDI	103	08.95	12.96				
	2.0	93	08.94	12.96	24.0711-1146.1	360060	2	Radsensor
	2.0	105	02.93	12.96				
	2.0 T	155	02.93	12.96				
	2.3 T5	166	02.93	12.96				
	2.3 T5 R	184	08.95	12.96				
	2.5	103	08.92	07.94				
	2.5	106	08.94	12.96				
	2.5	125	09.92	12.96				
	2.5 AWD	142	04.96	12.96				
	2.5 TDI	103	08.95	12.96				
	2.0	93	08.94	12.96	13.2381-0097.2	210239		D=38 ATE
	2.0	105	02.93	12.96	13.2381-0098.2	210240		D=38 ATE
	2.0 T	155	02.93	12.96	24.9238-0097.5	230037		D=38 ATE
	2.3 T5	166	02.93	12.96	24.9238-0098.5	230038		D=38 ATE
	2.5	103	08.92	07.94	13.0441-3815.2	250069		Dichtungssatz ATE
	2.5	106	08.94	12.96	13.0441-3819.2	250072		Dichtungssatz ATE
	2.5	125	09.92	12.96				
	2.5 TDI	103	08.95	12.96				
	2.3 T5 R	184	08.95	12.96	13.2381-0097.2	210239		D=38 ATE
					13.2381-0098.2	210240		D=38 ATE
					13.0441-3819.2	250072		Dichtungssatz ATE
	2.0	93	08.94	12.96	13.0460-3403.2	603403		20755 1,4 /Zub ATE
	2.0	105	02.93	12.96	13.0460-0088.2	610088		Belagsatz-Zubehör ATE
	2.0 T	155	02.93	12.96				
	2.3 T5	166	02.93	12.96				
	2.3 T5 R	184	08.95	12.96				
	2.5	103	08.92	07.94				
	2.5	106	08.94	12.96				
	2.5	125	09.92	12.96				
	2.5 TDI	103	08.95	12.96				
	2.5 AWD	142	04.96	12.96	13.0460-2935.2	602935		21385 13,8 /S LUC
	2.0	93	08.94	12.96	24.0110-0214.1	410214		295 9,6 8,4 +B
	2.0	105	02.93	12.96				
	2.0 T	155	02.93	12.96				
	2.3 T5	166	02.93	12.96				
	2.3 T5 R	184	08.95	12.96				
	2.5	103	09.93	07.94				
	2.5	106	08.94	12.96				
	2.5	125	09.93	12.96				
	2.5 TDI	103	08.95	12.96				
	2.5	103	08.92	08.93	24.0110-0216.1	410216		295 9,6 8,4
	2.5	125	09.92	08.93				
	2.5 AWD	142	04.96	12.96	24.0110-0292.1	410292		283 10,0 8,0
	2.0	93	08.94	12.96	24.5201-0204.3	331400	2	L=204
	2.0	105	02.93	12.96				
	2.0 T	155	02.93	12.96				
	2.3 T5	166	02.93	12.96				
	2.3 T5 R	184	08.95	12.96				
	2.5	103	08.92	07.94				
	2.5	106	08.94	12.96				
	2.5	125	09.92	12.96				
	2.5 TDI	103	08.95	12.96				
	2.5 AWD	142	04.96	12.96	83.6134-0300.3	330725	2	L=300
					83.6134-0270.3	330779	2	L=270
	2.0	93	08.94	12.96	24.0741-1105.1	360195	1	Radsensor L=1220/1840
	2.0	105	02.93	12.96				
	2.0 T	155	02.93	12.96				
	2.3 T5	166	02.93	12.96				
	2.3 T5 R	184	08.95	12.96				
	2.5	103	09.93	07.94				
	2.5	106	08.94	12.96				
	2.5	125	09.93	12.96				
	2.5 TDI	103	08.95	12.96				
	2.5	103	08.92	08.93	24.0721-1113.1	360193	2	Radsensor
	2.5	125	09.92	08.93				
	2.0	93	08.94	12.96	03.0137-0260.2	650260		178 x 25
	2.0	105	02.93	12.96	03.0137-9176.2	669176		Bremsbacken-Zubehör
	2.0 T	155	02.93	12.96				
	2.3 T5	166	02.93	12.96				
	2.3 T5 R	184	08.95	12.96				
	2.5	103	08.92	07.94				
	2.5	106	08.94	12.96				
	2.5	125	09.92	12.96				
	2.5 TDI	103	08.95	12.96				
	2.5 AWD	142	04.96	12.96	03.0137-0449.2	650449		178 x 25
	2.0	93	08.94	12.96	24.3727-1308.2	581308	2	L=1670
	2.0	105	02.93	12.96				
	2.0 T	155	02.93	12.96				
	2.3 T5	166	02.93	12.96				
	2.3 T5 R	184	08.95	12.96				

1) f.predec.13.2381-0065/-0066.2 / p.prece.13.2381-0065.2/-0066.2 / p.préd.13.2381-0065.2/-0066.2 / p.prede.13.2381-0065.2/-0066.2

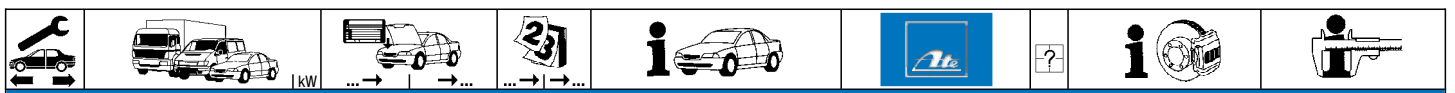

VOLVO 850 Kombi (92-96)





















	2.5	103		08.92	07.94		24.3727-1308.2	581308	2 ↓		L=1670
	2.5	106		08.94	12.96						
	2.5	125		09.92	12.96						
	2.5 TDI	103		08.95	12.96						
	2.0	93		08.94	08.95		03.6055-0431.3	320142			BR 5/35 (4) ATE
	2.0	105		02.93	08.95						
	2.0 T	155		02.93	08.95						
	2.3 T5	166		02.93	08.95						
	2.3 T5 R	184		08.95	08.95						
	2.5	103		08.92	07.94						
	2.5	106		08.94	08.95						
	2.5	125		09.92	08.95						
	2.5 TDI	103		08.95	08.95						
	2.0	93		08.94	12.96		24.2419-0939.3	030065		- Rohrleitung ¹⁾	Gz 19,05
	2.0	105		02.93	12.96						
	2.0 T	155		02.93	12.96						
	2.3 T5	166		02.93	12.96						
	2.3 T5 R	184		08.95	12.96						
	2.5	103		08.92	07.94						
	2.5	106		08.94	12.96						
	2.5	125		09.92	12.96						
	2.5 AWD	142		04.96	12.96						
	2.5 TDI	103		08.95	12.96						
	2.0	93		08.94	12.96		24.2522-0907.3	040043			Nz 22,20
	2.0	105		02.93	12.96						
	2.0 T	155		02.93	12.96						
	2.3 T5	166		02.93	12.96						
	2.5	103		08.92	07.94						
	2.5	106		08.94	12.96						
	2.5	125		09.92	12.96						
	2.5 AWD	142		04.96	12.96						
	2.5 TDI	103		08.95	12.96						

VOLVO 940 I Limousine (90-95)

	2.0 T	114		01.91	12.91	- ABS	03.2023-0503.3	010022			THz 23,81/16,84 + B. ATE
	2.3			08.90	12.91	- ABS	03.3517-5100.1	390326			Verschlußschraube ATE
	2.3	114		08.90	07.91	- ABS					
	2.3 T	121		08.90	12.91	- ABS					
	2.3 T	140		08.91	12.91	- ABS					
	2.4 D	60		08.90	12.91	- ABS					
	2.4 TD	80		08.90	12.91	- ABS					
	2.4 TD Intercooler	90		08.90	12.91	- ABS					
	2.0 T	114		01.91	12.91	+ ABS	03.2023-0164.3	010014			THz 23,81/19,05 + B. ATE
	2.3			08.90	12.91	+ ABS					
	2.3	114		08.90	07.91	+ ABS					
	2.3 T	121		08.90	12.91	+ ABS					
	2.3 T	140		08.91	12.91	+ ABS					
	2.4 D	60		08.90	12.91	+ ABS					
	2.4 TD	80		08.90	12.91	+ ABS					
	2.4 TD Intercooler	90		08.90	12.91	+ ABS					
	2.0	82		01.92	07.94		03.2023-0875.3	010890			THz 23,81/20,64 - B. ATE
	2.0 T	114		01.92	07.95						
	2.3			01.92	12.94						
	2.3	85		08.92	07.94						
	2.3 T	121		01.92	07.94						
	2.3 T	140		01.92	07.93						
	2.4 D	60		01.92	12.94						
	2.4 TD	80		01.92	12.94						
	2.4 TD Intercooler	90		01.92	12.94						
	2.0 T	114		01.91	12.91		24.3571-1707.5	240079	<input checked="" type="checkbox"/> + ABS		D=57, - Halter LUC
	2.3			08.90	12.91		24.3571-1708.5	240080	<input checked="" type="checkbox"/> + ABS		D=57, - Halter LUC
	2.3	114		08.90	07.91		24.0101-3401.2	260043	- ABS		Bremssattel-Zubehör LUC
	2.3 T	121		08.90	12.91		24.0101-3601.2	260044	+ ABS		Bremssattel-Zubehör LUC
	2.3 T	140		08.91	12.91						
	2.4 D	60		08.90	12.91						
	2.4 TD	80		08.90	12.91						
	2.4 TD Intercooler	90		08.90	12.91						
	2.0	82		01.92	07.94		24.3571-1707.5	240079	<input checked="" type="checkbox"/>		D=57, - Halter LUC
	2.0 T	114		01.92	07.95		24.3571-1708.5	240080	<input checked="" type="checkbox"/>		D=57, - Halter LUC
	2.3			01.92	12.94		24.0101-3601.2	260044			Bremssattel-Zubehör LUC
	2.3	85		08.92	07.94						
	2.3 T	121		01.92	07.94						
	2.3 T	140		01.92	07.93						
	2.4 D	60		01.92	12.94						
	2.4 TD	80		01.92	12.94						
	2.4 TD Intercooler	90		01.92	12.94						
	2.0 T	114		01.91	12.91		13.0460-3914.2	603914	- ABS		21233 16,7 BDX
	2.3			08.90	12.91		13.0460-2943.2	602943	- ABS		21266 17,0 /S LUC
	2.3	114		08.90	07.91		13.0460-2985.2	602985	+ ABS		20164 18,2 LUC
	2.3 T	121		08.90	12.91		13.0460-0429.2	610429			Belagsatz-Zubehör BDX
	2.3 T	140		08.91	12.91						
	2.4 D	60		08.90	12.91						
	2.4 TD	80		08.90	12.91						
	2.4 TD Intercooler	90		08.90	12.91						

¹⁾ - pipe line / - tubazione / - conduite rigide / - latiguillo



										
VOLVO 940 I Limousine (90-95)										
	2.0	82		01.92	07.94	13.0460-3914.2	603914		21233 16,7	BDX
	2.0 T	114		01.92	07.95	13.0460-2985.2	602985		20164 18,2	LUC
	2.3			01.92	12.94	13.0460-0429.2	610429		Belagsatz-Zubehör	BDX
	2.3	85		08.92	07.94					
	2.3 T	121		01.92	07.94					
	2.3 T	140		01.92	07.93					
	2.4 D	60		01.92	12.94					
	2.4 TD	80		01.92	12.94					
	2.4 TD Intercooler	90		01.92	12.94					
	2.0 T	114		01.91	12.91	24.0122-0137.1	422137	- ABS	287 22,0 20,0 V	
	2.3			08.90	12.91	24.0126-0105.1	426105	+ ABS	280 26,0 23,0 V +B	
	2.3	114		08.90	07.91					
	2.3 T	121		08.90	12.91					
	2.3 T	140		08.91	12.91					
	2.4 D	60		08.90	12.91					
	2.4 TD	80		08.90	12.91					
	2.4 TD Intercooler	90		08.90	12.91					
	2.0	82		01.92	07.94	24.0126-0105.1	426105		280 26,0 23,0 V +B	
	2.0 T	114		01.92	07.95					
	2.3			01.92	12.94					
	2.3	85		08.92	07.94					
	2.3 T	121		01.92	07.94					
	2.3 T	140		01.92	07.93					
	2.4 D	60		01.92	12.94					
	2.4 TD	80		01.92	12.94					
	2.4 TD Intercooler	90		01.92	12.94					
	2.0 T	114		01.91	12.91	83.6134-0335.3	330277	2	L=335	
	2.3			08.90	12.91					
	2.3	114		08.90	07.91					
	2.3 T	121		08.90	12.91					
	2.3 T	140		08.91	12.91					
	2.4 D	60		08.90	12.91					
	2.4 TD	80		08.90	12.91					
	2.4 TD Intercooler	90		08.90	12.91					
	2.0	82		01.92	07.94	83.6134-0335.3	330277	2	L=335	
	2.0 T	114		01.91	12.91					
	2.0 T	114		01.92	07.95					
	2.3			08.90	12.91					
	2.3	85		08.92	07.94					
	2.3	114		08.90	07.91					
	2.3 T	121		08.90	12.91					
	2.3 T	121		01.92	07.94					
	2.3 T	140		08.91	12.91					
	2.3 T	140		01.92	07.93					
	2.4 D	60		08.90	12.91					
	2.4 D	60		01.92	12.94					
	2.4 TD	80		08.90	12.91					
	2.4 TD	80		01.92	12.94					
	2.4 TD Intercooler	90		08.90	12.91					
	2.4 TD Intercooler	90		01.92	12.94					
	2.0	82		01.92	07.94	24.9238-0087.5	230035		D=38	ATE
	2.0 T	114		01.91	07.95	24.9238-0088.5	230036		D=38	ATE
	2.3			08.90	12.94	13.2401-0027.2	210045		D=40	ATE
	2.3	85		08.92	07.94	13.2401-0028.2	210046		D=40	ATE
	2.3	114		08.90	07.91	24.9240-0028.5	230018		D=40	ATE
	2.3 T	121		08.90	07.94	13.0441-3815.2	250069	für 13.2381-0087/-0088.2 ²⁾	Dichtungssatz	ATE
	2.3 T	140		08.90	07.94	13.0441-3819.2	250072		Dichtungssatz	ATE
	2.3 T	140		08.91	07.93	13.0441-4014.2	250079	für 13.2401-0027/-0028.2 ³⁾	Dichtungssatz	ATE
	2.4 D	60		08.90	12.94					
	2.4 TD	80		08.90	12.94					
	2.4 TD Intercooler	90		08.90	12.94					
	2.0	82		01.92	07.94	13.0460-3401.2	603401		20755 14,4	ATE
	2.0 T	114		01.91	07.95	13.0460-0088.2	610088		Belagsatz-Zubehör	ATE
	2.3			08.90	12.94					
	2.3	85		08.92	07.94					
	2.3	114		08.90	07.91					
	2.3 T	121		08.90	07.94					
	2.3 T	140		08.91	07.93					
	2.4 D	60		08.90	12.94					
	2.4 TD	80		08.90	12.94					
	2.4 TD Intercooler	90		08.90	12.94					
	2.0	82		01.92	07.94	13.0460-2935.2	602935		21385 13,8 /S	LUC
	2.0 T	114		01.91	07.95					
	2.3			08.90	12.94					
	2.3	85		08.92	07.94					
	2.3	114		08.90	07.91					
	2.3 T	121		08.90	07.94					
	2.3 T	140		08.91	07.93					
	2.4 D	60		08.90	12.94					
	2.4 TD	80		08.90	12.94					
	2.4 TD Intercooler	90		08.90	12.94					
	2.0	82		01.92	07.94	24.0110-0189.1	410189		281 9,6 8,4 +B	
	2.0 T	114		01.91	07.95					
	2.3			08.90	12.94					
	2.3	85		08.92	07.94					
	2.3	114		08.90	07.91					

1) - multi link axle / - assale Multi-link / - essieu multi-link / - eje Multi-Link

2) for 13.2381-0087/-0088.2 / per 13.2381-0087/-0088.2 / pour 13.2381-0087/-0088.2 / para 13.2381-0087/-0088.2

3) for 13.2401-0027/-0028.2 / per 13.2401-0027/-0028.2 / pour 13.2401-0027/-0028.2 / para 13.2401-0027/-0028.2

4) + multi link axle / + assale Multi-link / + essieu multi-link / + eje Multi-Link

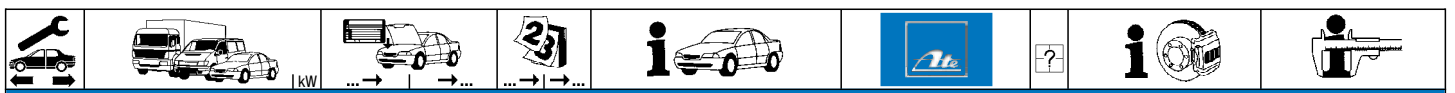

VOLVO 940 I Limousine (90-95)

	2.3 T	121		08.90	07.94	- Multi-Link-Achse 1)	24.0110-0189.1	410189		281 9,6 8,4 +B
	2.3 T	140		08.91	07.93	- Multi-Link-Achse 1)				
	2.4 D	60		08.90	12.94	- Multi-Link-Achse 1)				
	2.4 TD	80		08.90	12.94	- Multi-Link-Achse 1)				
	2.4 TD Intercooler	90		08.90	12.94	- Multi-Link-Achse 1)				
	2.0	82		01.92	07.94	+ Multi-Link-Achse 2)	24.0110-0206.1	410206		265 10,0 8,0
	2.0 T	114		01.91	07.95	+ Multi-Link-Achse 2)				
	2.3			08.90	12.94	+ Multi-Link-Achse 2)				
	2.3	85		08.92	07.94	+ Multi-Link-Achse 2)				
	2.3	114		08.90	07.91	+ Multi-Link-Achse 2)				
2.3 T	121		08.90	07.94	+ Multi-Link-Achse 2)					
2.3 T	140		08.91	07.93	+ Multi-Link-Achse 2)					
2.4 D	60		08.90	12.94	+ Multi-Link-Achse 2)					
2.4 TD	80		08.90	12.94	+ Multi-Link-Achse 2)					
2.4 TD Intercooler	90		08.90	12.94	+ Multi-Link-Achse 2)					
	2.0	82		01.92	07.94		83.6124-0305.3	330723	2	L=305
	2.0 T	114		01.91	07.95					
	2.3			08.90	12.94					
	2.3	85		08.92	07.94					
	2.3	114		08.90	07.91					
	2.3 T	121		08.90	07.94					
	2.3 T	140		08.91	07.93					
	2.4 D	60		08.90	12.94					
	2.4 TD	80		08.90	12.94					
	2.4 TD Intercooler	90		08.90	12.94					
	2.0	82		01.92	07.94	- Multi-Link-Achse 1)	03.0137-0169.2	650169		160 x 25
	2.0 T	114		01.91	07.95	- Multi-Link-Achse 1)	03.0137-9065.2	669065		Bremsbacken-Zubehör
	2.3			08.90	12.94	- Multi-Link-Achse 1)				
	2.3	85		08.92	07.94	- Multi-Link-Achse 1)				
	2.3	114		08.90	07.91	- Multi-Link-Achse 1)				
	2.3 T	121		08.90	07.94	- Multi-Link-Achse 1)				
	2.3 T	140		08.91	07.93	- Multi-Link-Achse 1)				
	2.4 D	60		08.90	12.94	- Multi-Link-Achse 1)				
	2.4 TD	80		08.90	12.94	- Multi-Link-Achse 1)				
	2.4 TD Intercooler	90		08.90	12.94	- Multi-Link-Achse 1)				
	2.0	82		01.92	07.94	+ Multi-Link-Achse 2)	03.0137-0299.2	650299		160 x 25
	2.0 T	114		01.91	07.95	+ Multi-Link-Achse 2)	03.0137-9199.2	669199		Bremsbacken-Zubehör
	2.3			08.90	12.94	+ Multi-Link-Achse 2)				
	2.3	85		08.92	07.94	+ Multi-Link-Achse 2)				
	2.3	114		08.90	07.91	+ Multi-Link-Achse 2)				
	2.3 T	121		08.90	07.94	+ Multi-Link-Achse 2)				
	2.3 T	140		08.91	07.93	+ Multi-Link-Achse 2)				
	2.4 D	60		08.90	12.94	+ Multi-Link-Achse 2)				
	2.4 TD	80		08.90	12.94	+ Multi-Link-Achse 2)				
	2.4 TD Intercooler	90		08.90	12.94	+ Multi-Link-Achse 2)				
	2.0	82		01.92	07.94		03.6055-0430.3	320065		BR 5/25 (4) ATE
	2.0 T	114		01.91	07.95					
	2.3			08.90	12.94					
	2.3	85		08.92	07.94					
	2.3	114		08.90	07.91					
	2.3 T	121		08.90	07.94					
	2.3 T	140		08.91	07.93					
	2.4 D	60		08.90	12.94					
	2.4 TD	80		08.90	12.94					
	2.4 TD Intercooler	90		08.90	12.94					
	2.0	82		01.92	07.94		24.2419-0941.3	030067		Gz 19,05
	2.0 T	114		01.91	07.95					
	2.3			08.90	12.94					
	2.3	85		08.92	07.94					
	2.3	114		08.90	07.91					
	2.3 T	121		08.90	07.94		24.2419-0928.3	030056		Gz 19,05
	2.3 T	140		08.91	07.93					
	2.4 TD	80		08.90	12.94					
	2.4 TD Intercooler	90		08.90	12.94					
	2.0	82		01.92	07.94		24.2520-0905.3	040057		Nz 20,64
	2.0 T	114		01.91	07.95					
	2.3			08.90	12.94					
	2.3	85		08.92	07.94					
	2.3	114		08.90	07.91					
	2.4 D	60		08.90	12.94					
	2.3 T	121		08.90	07.94		03.2522-0420.3	040086		Nz 22,20
	2.3 T	140		08.91	07.93					
	2.4 TD	80		08.90	12.94					
2.4 TD Intercooler	90		08.90	12.94						

VOLVO 940 I Kombi (90-95)

	2.0 T	114		01.91	12.91	- ABS	03.2023-0503.3	010022		THz 23,81/16,84 + B. ATE
	2.3	96		08.90	12.91	- ABS	03.3517-5100.1	390326		Verschlußschraube ATE
	2.3	114		08.90	07.91	- ABS				
	2.3 T	121		08.90	12.91	- ABS				
	2.3 T	140		08.91	12.91	- ABS				
	2.4 D	60		08.90	12.91	- ABS				
	2.4 TD	80		08.90	12.91	- ABS				
	2.4 TD Intercooler	90		08.90	12.91	- ABS				
↓	2.0 T	114		01.91	12.91	+ ABS	03.2023-0164.3	010014		THz 23,81/19,05 + B. ATE

1) - multi link axle / - assale Multi-link / - essieu multi-link / - eje Multi-Link
 2) + multi link axle / + assale Multi-link / + essieu multi-link / + eje Multi-Link



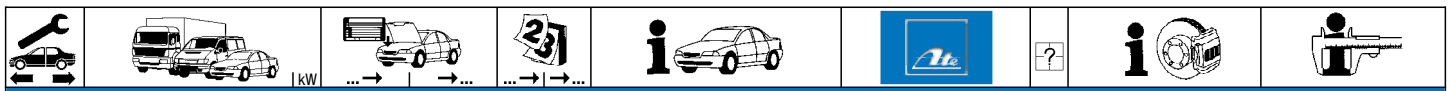

VOLVO 940 I Kombi (90-95)

	2.3 2.3 2.3 T 2.3 T 2.4 D 2.4 TD 2.4 TD Intercooler	96 114 121 140 60 80 90	08.90 08.90 08.90 08.91 08.90 08.90 08.90	12.91 07.91 12.91 12.91 12.91 12.91 12.91	+ ABS + ABS + ABS + ABS + ABS + ABS + ABS	03.2023-0164.3 010014		THz 23,81/19,05 + B.	ATE	
	2.0 2.0 T 2.3 2.3 2.3 T 2.3 T 2.4 D 2.4 TD 2.4 TD Intercooler	82 114 85 96 121 140 60 80 90	01.92 01.92 08.92 01.92 01.92 01.92 01.92 01.92 01.92	07.94 07.95 07.94 07.94 07.93 07.95 07.94 07.94 07.94		03.2023-0875.3 010890		THz 23,81/20,64 - B.	ATE	
	2.0 T 2.3 2.3 2.3 T 2.3 T 2.4 D 2.4 TD 2.4 TD Intercooler	114 96 114 121 140 60 80 90	01.91 08.90 08.90 08.90 08.91 08.90 08.90 08.90	12.91 12.91 07.91 12.91 12.91 12.91 12.91 12.91		24.3571-1707.5 24.3571-1708.5 24.0101-3401.2 24.0101-3601.2	240079 240080 260043 260044	+ ABS + ABS - ABS + ABS	D=57, - Halter D=57, - Halter Bremsattel-Zubehör Bremsattel-Zubehör	LUC LUC LUC LUC
	2.0 T 2.3 2.3 2.3 T 2.3 T 2.4 D 2.4 TD 2.4 TD Intercooler	114 96 114 121 140 60 80 90	01.91 08.90 08.90 08.90 08.91 08.90 08.90 08.90	12.91 12.91 07.91 12.91 12.91 12.91 12.91 12.91		13.0460-3914.2 13.0460-2943.2 13.0460-2985.2 13.0460-0429.2	603914 602943 602985 610429	- ABS - ABS + ABS - ABS	21233 16,7 21266 17,0 /S 20164 18,2 Belagsatz-Zubehör	BDX LUC LUC BDX
	2.0 2.0 T 2.3 2.3 2.3 T 2.3 T 2.4 D 2.4 TD 2.4 TD Intercooler	82 114 85 96 121 140 60 80 90	01.92 01.92 08.92 01.92 01.92 01.92 01.92 01.92 01.92	07.94 07.95 07.94 07.94 07.93 07.95 07.94 07.94 07.94		13.0460-3914.2 13.0460-2943.2 13.0460-0429.2 13.0460-2985.2	603914 602943 610429 602985	- ABS - ABS + ABS	21233 16,7 21266 17,0 /S Belagsatz-Zubehör 20164 18,2	BDX LUC BDX LUC
	2.0 2.0 T 2.3 2.3 2.3 T 2.3 T 2.4 D 2.4 TD 2.4 TD Intercooler	82 114 96 114 121 140 60 80 90	01.92 01.91 08.90 08.90 08.90 08.91 08.90 08.90 08.90	12.92 12.91 12.91 07.91 12.91 12.91 12.91 12.91 12.91		24.0122-0137.1 24.0126-0105.1	422137 426105	- ABS + ABS	287 22,0 20,0 V 280 26,0 23,0 V +B	
	2.0 2.0 T 2.3 2.3 2.3 T 2.3 T 2.4 D 2.4 TD 2.4 TD Intercooler	82 114 85 96 121 140 60 80 90	01.93 01.92 08.92 01.92 01.92 01.92 01.92 01.92 01.92	07.94 07.95 07.94 07.94 07.93 07.95 07.94 07.94 07.94		24.0126-0105.1	426105	+ ABS	280 26,0 23,0 V +B	
	2.0 T 2.3 2.3 2.3 T 2.3 T 2.4 D 2.4 TD 2.4 TD Intercooler	114 96 114 121 140 60 80 90	01.91 08.90 08.90 08.90 08.91 08.90 08.90 08.90	12.91 12.91 07.91 12.91 12.91 12.91 12.91 12.91	- ABS - ABS - ABS - ABS - ABS - ABS - ABS - ABS	83.6134-0335.3	330277	2	L=335	
	2.0 2.0 T 2.0 T 2.3 2.3 2.3 2.3 2.3 T 2.3 T 2.3 T 2.3 T 2.4 D 2.4 D 2.4 TD 2.4 TD 2.4 TD Intercooler 2.4 TD Intercooler	82 114 114 85 96 96 114 121 121 140 140 60 60 80 80 90 90	01.92 01.91 01.92 08.92 08.90 01.92 01.92 01.92 01.92 01.92 01.92 08.90 01.92 01.92 08.90 08.90	07.94 12.91 07.95 07.94 12.91 12.91 12.91 12.91 12.91 12.91 12.91 12.91 12.91 12.91 12.91 12.91	+ ABS + ABS + ABS + ABS + ABS + ABS + ABS + ABS + ABS + ABS + ABS + ABS + ABS + ABS + ABS	83.6134-0335.3	330277	2	L=335	



VOLVO 940 I Kombi (90-95)		kW		231		i		Ate		?		i		Key	
	2.0	82	01.92	07.94	- Multi-Link-Achse 1)	24.9238-0087.5	230035	für 13.2381-0087/-0088.2 2)	D=38 D=38 D=40 D=40 D=40 D=40 Dichtungssatz Dichtungssatz Dichtungssatz	ATE ATE ATE ATE ATE ATE ATE ATE ATE					
	2.0 T	114	01.91	07.95	- Multi-Link-Achse 1)	24.9238-0088.5	230036								
	2.3	85	08.92	07.94	- Multi-Link-Achse 1)	13.2401-0027.2	210045								
	2.3	96	08.90	07.94	- Multi-Link-Achse 1)	13.2401-0028.2	210046								
	2.3	114	08.90	07.91	- Multi-Link-Achse 1)	24.9240-0028.5	230018								
	2.3 T	121	08.90	07.94	- Multi-Link-Achse 1)	13.0441-3815.2	250069								
	2.3 T	140	08.91	07.93	- Multi-Link-Achse 1)	13.0441-3819.2	250072								
	2.4 D	60	08.90	07.95	- Multi-Link-Achse 1)	13.0441-4014.2	250079								
	2.4 TD	80	08.90	07.94	- Multi-Link-Achse 1)										
	2.4 TD Intercooler	90	08.90	07.94	- Multi-Link-Achse 1)										
	2.0	82	01.92	07.94	- Multi-Link-Achse 1)	13.0460-3401.2	603401		20755 14,4 Belagsatz-Zubehör	ATE ATE					
	2.0 T	114	01.91	07.95	- Multi-Link-Achse 1)	13.0460-0088.2	610088								
	2.3	85	08.92	07.94	- Multi-Link-Achse 1)										
	2.3	96	08.90	07.94	- Multi-Link-Achse 1)										
	2.3	114	08.90	07.91	- Multi-Link-Achse 1)										
	2.3 T	121	08.90	07.94	- Multi-Link-Achse 1)										
	2.3 T	140	08.91	07.93	- Multi-Link-Achse 1)										
	2.4 D	60	08.90	07.95	- Multi-Link-Achse 1)										
	2.4 TD	80	08.90	07.94	- Multi-Link-Achse 1)										
	2.4 TD Intercooler	90	08.90	07.94	- Multi-Link-Achse 1)										
	2.0	82	01.92	07.94	+ Multi-Link-Achse 4)	13.0460-2935.2	602935		21385 13,8 / S	LUC					
	2.0 T	114	01.91	07.95	+ Multi-Link-Achse 4)										
	2.3	85	08.92	07.94	+ Multi-Link-Achse 4)										
	2.3	96	08.90	07.94	+ Multi-Link-Achse 4)										
	2.3	114	08.90	07.91	+ Multi-Link-Achse 4)										
	2.3 T	121	08.90	07.94	+ Multi-Link-Achse 4)										
	2.3 T	140	08.91	07.93	+ Multi-Link-Achse 4)										
	2.4 D	60	08.90	07.95	+ Multi-Link-Achse 4)										
	2.4 TD	80	08.90	07.94	+ Multi-Link-Achse 4)										
	2.4 TD Intercooler	90	08.90	07.94	+ Multi-Link-Achse 4)										
	2.0	82	01.92	07.94	- Multi-Link-Achse 1)	24.0110-0189.1	410189		281 9,6 8,4 +B						
	2.0 T	114	01.91	07.95	- Multi-Link-Achse 1)										
	2.3	85	08.92	07.94	- Multi-Link-Achse 1)										
	2.3	96	08.90	07.94	- Multi-Link-Achse 1)										
	2.3	114	08.90	07.91	- Multi-Link-Achse 1)										
	2.3 T	121	08.90	07.94	- Multi-Link-Achse 1)										
	2.3 T	140	08.91	07.93	- Multi-Link-Achse 1)										
	2.4 D	60	08.90	07.95	- Multi-Link-Achse 1)										
	2.4 TD	80	08.90	07.94	- Multi-Link-Achse 1)										
	2.4 TD Intercooler	90	08.90	07.94	- Multi-Link-Achse 1)										
	2.0	82	01.92	07.94	+ Multi-Link-Achse 4)	24.0110-0206.1	410206		265 10,0 8,0						
	2.0 T	114	01.91	07.95	+ Multi-Link-Achse 4)										
	2.3	85	08.92	07.94	+ Multi-Link-Achse 4)										
	2.3	96	08.90	07.94	+ Multi-Link-Achse 4)										
	2.3	114	08.90	07.91	+ Multi-Link-Achse 4)										
	2.3 T	121	08.90	07.94	+ Multi-Link-Achse 4)										
	2.3 T	140	08.91	07.93	+ Multi-Link-Achse 4)										
	2.4 D	60	08.90	07.95	+ Multi-Link-Achse 4)										
	2.4 TD	80	08.90	07.94	+ Multi-Link-Achse 4)										
	2.4 TD Intercooler	90	08.90	07.94	+ Multi-Link-Achse 4)										
	2.0	82	01.92	07.94	- Multi-Link-Achse 1)	83.6124-0305.3	330723	2	L=305						
	2.0 T	114	01.91	07.95	- Multi-Link-Achse 1)										
	2.3	85	08.92	07.94	- Multi-Link-Achse 1)										
	2.3	96	08.90	07.94	- Multi-Link-Achse 1)										
	2.3	114	08.90	07.91	- Multi-Link-Achse 1)										
	2.3 T	121	08.90	07.94	- Multi-Link-Achse 1)										
	2.3 T	140	08.91	07.93	- Multi-Link-Achse 1)										
	2.4 D	60	08.90	07.95	- Multi-Link-Achse 1)										
	2.4 TD	80	08.90	07.94	- Multi-Link-Achse 1)										
	2.4 TD Intercooler	90	08.90	07.94	- Multi-Link-Achse 1)										
	2.0	82	01.92	07.94	- Multi-Link-Achse 1)	03.0137-0169.2	650169		160 x 25 Bremsbacken-Zubehör						
	2.0 T	114	01.91	07.95	- Multi-Link-Achse 1)	03.0137-9065.2	669065								
	2.3	85	08.92	07.94	- Multi-Link-Achse 1)										
	2.3	96	08.90	07.94	- Multi-Link-Achse 1)										
	2.3	114	08.90	07.91	- Multi-Link-Achse 1)										
	2.3 T	121	08.90	07.94	- Multi-Link-Achse 1)										
	2.3 T	140	08.91	07.93	- Multi-Link-Achse 1)										
	2.4 D	60	08.90	07.95	- Multi-Link-Achse 1)										
	2.4 TD	80	08.90	07.94	- Multi-Link-Achse 1)										
	2.4 TD Intercooler	90	08.90	07.94	- Multi-Link-Achse 1)										
	2.0	82	01.92	07.94	+ Multi-Link-Achse 4)	03.0137-0299.2	650299		160 x 25 Bremsbacken-Zubehör						
	2.0 T	114	01.91	07.95	+ Multi-Link-Achse 4)	03.0137-9199.2	669199								
	2.3	85	08.92	07.94	+ Multi-Link-Achse 4)										
	2.3	96	08.90	07.94	+ Multi-Link-Achse 4)										
	2.3	114	08.90	07.91	+ Multi-Link-Achse 4)										
	2.3 T	121	08.90	07.94	+ Multi-Link-Achse 4)										
	2.3 T	140	08.91	07.93	+ Multi-Link-Achse 4)										
	2.4 D	60	08.90	07.95	+ Multi-Link-Achse 4)										
	2.4 TD	80	08.90	07.94	+ Multi-Link-Achse 4)										
	2.4 TD Intercooler	90	08.90	07.94	+ Multi-Link-Achse 4)										
	2.0	82	01.92	07.94	- Multi-Link-Achse 1)	03.6055-0431.3	320142		BR 5/35 (4)	ATE					
	2.0 T	114	01.91	07.95	- Multi-Link-Achse 1)										
	2.3	85	08.92	07.94	- Multi-Link-Achse 1)										
	2.3	96	08.90	07.94	- Multi-Link-Achse 1)										
	2.3 T	121	08.90	07.91	- Multi-Link-Achse 1)										

1) - multi link axle / - assale Multi-link / - essieu multi-link / - eje Multi-Link
2) for 13.2381-0087/-0088.2 / per 13.2381-0087/-0088.2 / pour 13.2381-0087/-0088.2 / para 13.2381-0087/-0088.2
3) for 13.2401-0027/-0028.2 / per 13.2401-0027/-0028.2 / pour 13.2401-0027/-0028.2 / para 13.2401-0027/-0028.2
4) + multi link axle / + assale Multi-link / + essieu multi-link / + eje Multi-Link

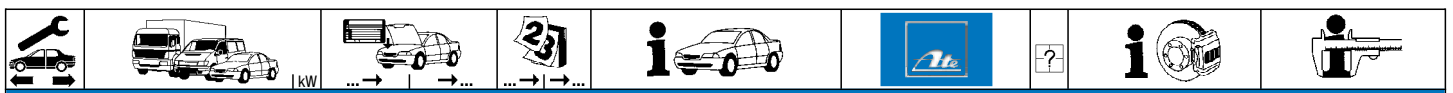

VOLVO 940 I Kombi (90-95)























	2.3 T 2.4 D 2.4 TD 2.4 TD Intercooler	140 60 80 90		08.91 08.90 08.90 08.90	07.93 07.95 07.94 07.94		03.6055-0431.3	320142			BR 5/35 (4)	ATE
	2.0 2.0 T 2.3 2.3 2.3 2.4 D	82 114 85 96 114 60		01.92 01.91 08.92 08.90 08.90 08.90	07.94 07.95 07.94 07.94 07.91 07.95		24.2419-0941.3	030067			Gz 19,05	
	2.3 T 2.3 T 2.4 TD 2.4 TD Intercooler	121 140 80 90		08.90 08.91 08.90 08.90	07.94 07.93 07.94 07.94		24.2419-0928.3	030056			Gz 19,05	
	2.0 2.0 T 2.3 2.3 2.3 2.4 D	82 114 85 96 114 60		01.92 01.91 08.92 08.90 08.90 08.90	07.94 07.95 07.94 07.94 07.91 07.95		24.2520-0905.3	040057			Nz 20,64	
	2.3 T 2.3 T 2.4 TD 2.4 TD Intercooler	121 140 80 90		08.90 08.91 08.90 08.90	07.94 07.93 07.94 07.94		03.2522-0420.3	040086			Nz 22,20	

VOLVO 960 I Limousine (90-94)

	2.0 2.0 2.4 TD Intercooler 2.9	103 140 85 150		09.90 08.90 09.91 08.90	12.91 12.91 12.91 12.91		03.2023-0164.3	010014			Thz 23,81/19,05 + B.	ATE
	2.0 2.0 2.4 TD Intercooler 2.9	103 140 85 150		01.92 01.92 01.92 01.92	08.93 09.93 07.94 07.94		03.2023-0875.3	010890			Thz 23,81/20,64 - B.	ATE
	2.0 2.0 2.4 TD Intercooler 2.9	103 140 85 150		09.90 08.90 09.91 08.90	08.93 09.93 07.94 07.94		24.3571-1707.5 24.3571-1708.5 24.0101-3601.2	240079 240080 260044			D=57, - Halter D=57, - Halter Bremsattel-Zubehör	LUC LUC LUC
	2.0 2.0 2.4 TD Intercooler 2.9	103 140 85 150		09.90 08.90 09.91 08.90	08.93 09.93 07.94 07.94		13.0460-2985.2	602985			20164 18,2	LUC
	2.0 2.0 2.4 TD Intercooler 2.9	103 140 85 150		09.90 08.90 09.91 08.90	08.93 09.93 07.94 07.94		24.0126-0105.1	426105			280 26,0 23,0 V +B	
	2.0 2.0 2.4 TD Intercooler 2.9	103 140 85 150		09.90 08.90 09.91 08.90	08.93 09.93 07.94 07.94		83.6134-0335.3	330277	2		L=335	
	2.0 2.0 2.4 TD Intercooler 2.9	103 140 85 150		09.90 08.90 09.91 08.90	08.93 09.93 07.94 07.94	- Multi-Link-Achse 1) - Multi-Link-Achse 1) - Multi-Link-Achse 1) - Multi-Link-Achse 1)	24.9238-0087.5 24.9238-0088.5 13.2401-0027.2 13.2401-0028.2 24.9240-0028.5 13.0441-4014.2	230035 230036 210045 210046 230018 250079		D=40	D=38 D=38 D=40 D=40 D=40 Dichtungssatz	ATE ATE ATE ATE ATE ATE
	2.0 2.0 2.4 TD Intercooler 2.9	103 140 85 150		09.90 08.90 09.91 08.90	08.93 09.93 07.94 07.94	- Multi-Link-Achse 1) - Multi-Link-Achse 1) - Multi-Link-Achse 1) - Multi-Link-Achse 1)	13.0460-3401.2 13.0460-0088.2	603401 610088			20755 14,4 Belagsatz-Zubehör	ATE ATE
	2.0 2.0 2.4 TD Intercooler 2.9	103 140 85 150		09.90 08.90 09.91 08.90	08.93 09.93 07.94 07.94	- Multi-Link-Achse 2) + Multi-Link-Achse 2) + Multi-Link-Achse 2) + Multi-Link-Achse 2)	13.0460-2935.2	602935			21385 13,8 /S	LUC
	2.0 2.0 2.4 TD Intercooler 2.9	103 140 85 150		09.90 08.90 09.91 08.90	08.93 09.93 07.94 07.94	- Multi-Link-Achse 1) - Multi-Link-Achse 1) - Multi-Link-Achse 1) - Multi-Link-Achse 1)	24.0110-0189.1	410189			281 9,6 8,4 +B	
	2.0 2.0 2.4 TD Intercooler 2.9	103 140 85 150		09.90 08.90 09.91 08.90	08.93 09.93 07.94 07.94	+ Multi-Link-Achse 2) + Multi-Link-Achse 2) + Multi-Link-Achse 2) + Multi-Link-Achse 2)	24.0110-0206.1	410206			265 10,0 8,0	
	2.0 2.0 2.4 TD Intercooler 2.9	103 140 85 150		09.90 08.90 09.91 08.90	12.91 12.91 12.91 12.91		83.6134-0300.3	330725	2		L=300	
	2.0 2.0 2.4 TD Intercooler 2.9	103 140 85 150		01.92 01.92 01.92 01.92	08.93 09.93 07.94 07.94		83.6124-0305.3	330723	2		L=305	
	2.0 2.0 2.4 TD Intercooler 2.9	103 140 85 150		09.90 08.90 09.91 08.90	08.93 09.93 07.94 07.94	- Multi-Link-Achse 1) - Multi-Link-Achse 1) - Multi-Link-Achse 1) - Multi-Link-Achse 1)	03.0137-0169.2 03.0137-9065.2	650169 669065			160 x 25 Bremsbacken-Zubehör	

1) - multi link axle / - assale Multi-link / - essieu multi-link / - eje Multi-Link
2) + multi link axle / + assale Multi-link / + essieu multi-link / + eje Multi-Link



































								
VOLVO 960 I Limousine (90-94)								
	2.0	103	09.90	08.93	+ Multi-Link-Achse ¹⁾	03.0137-0299.2	650299	160 x 25 Bremsbacken-Zubehör
	2.0	140	08.90	09.93	+ Multi-Link-Achse ¹⁾	03.0137-9199.2	669199	
	2.4 TD Intercooler	85	09.91	07.94	+ Multi-Link-Achse ¹⁾			
	2.9	150	08.90	07.94	+ Multi-Link-Achse ¹⁾			
	2.0	103	09.90	08.93		03.6055-0430.3	320065	BR 5/25 (4) ATE
	2.0	140	08.90	09.93				
	2.9	150	08.90	07.94				
	2.4 TD Intercooler	85	09.91	07.94		03.6055-0431.3	320142	BR 5/35 (4) ATE
	2.0	103	09.90	08.93		24.2419-0928.3	030056	Gz 19,05
	2.0	140	08.90	09.93				
	2.4 TD Intercooler	85	09.91	07.94				
	2.0	103	09.90	08.93		03.2522-0420.3	040086	Nz 22,20
	2.0	140	08.90	09.93				
	2.4 TD Intercooler	85	09.91	07.94				
VOLVO 960 I Kombi (90-94)								
	2.0	103	09.90	12.91		03.2023-0164.3	010014	THz 23,81/19,05 + B. ATE
	2.0	140	08.90	12.91				
	2.4 TD Intercooler	85	09.91	12.91				
	2.8	108	09.90	12.91				
	2.8	115	09.90	12.91				
	2.9	150	08.90	12.91				
	2.0	103	01.92	08.93		03.2023-0875.3	010890	THz 23,81/20,64 - B. ATE
	2.0	140	01.92	09.93				
	2.4 TD Intercooler	85	01.92	07.94				
	2.8	108	01.92	05.92				
	2.8	115	01.92	05.92				
	2.9	150	01.92	07.94				
	2.0	103	09.90	08.93		24.3571-1707.5	240079	D=57, - Halter LUC
	2.0	140	08.90	09.93		24.3571-1708.5	240080	D=57, - Halter LUC
	2.4 TD Intercooler	85	09.91	07.94		24.0101-3601.2	260044	Bremssattel-Zubehör LUC
	2.8	108	09.90	05.92				
	2.8	115	09.90	05.92				
	2.9	150	08.90	07.94				
	2.0	103	09.90	08.93		13.0460-2985.2	602985	20164 18,2 LUC
	2.0	140	08.90	09.93				
	2.4 TD Intercooler	85	09.91	07.94				
	2.8	108	09.90	05.92				
	2.8	115	09.90	05.92				
	2.9	150	08.90	07.94				
	2.0	103	09.90	08.93		24.0126-0105.1	426105	280 26,0 23,0 V + B
	2.0	140	08.90	09.93				
	2.4 TD Intercooler	85	09.91	07.94				
	2.8	108	09.90	05.92				
	2.8	115	09.90	05.92				
	2.9	150	08.90	07.94				
	2.0	103	09.90	08.93		83.6134-0335.3	330277	L=335
	2.0	140	08.90	09.93				
	2.4 TD Intercooler	85	09.91	07.94				
	2.8	108	09.90	05.92				
	2.8	115	09.90	05.92				
	2.9	150	08.90	07.94				
	2.0	103	09.90	08.93	- Multi-Link-Achse ²⁾	24.9238-0087.5	230035	D=38 ATE
	2.0	140	08.90	09.93	- Multi-Link-Achse ²⁾	24.9238-0088.5	230036	D=38 ATE
	2.4 TD Intercooler	85	09.91	07.94	- Multi-Link-Achse ²⁾	13.2401-0027.2	210045	D=40 ATE
	2.8	108	09.90	05.92	- Multi-Link-Achse ²⁾	13.2401-0028.2	210046	D=40 ATE
	2.8	115	09.90	05.92	- Multi-Link-Achse ²⁾	24.9240-0028.5	230018	D=40 ATE
	2.9	150	08.90	07.94	- Multi-Link-Achse ²⁾	13.0441-3815.2	250069	Dichtungssatz ATE
						13.0441-3819.2	250072	Dichtungssatz ATE
						13.0441-4014.2	250079	Dichtungssatz ATE
								für Vorg. 13.2381-0067/-0068.2 ³⁾
								für Vorg. 13.2401-0023/-0024.2 ⁴⁾
	2.0	103	09.90	08.93	- Multi-Link-Achse ²⁾	13.0460-3401.2	603401	20755 14,4 ATE
	2.0	140	08.90	09.93	- Multi-Link-Achse ²⁾	13.0460-0088.2	610088	Belagsatz-Zubehör ATE
	2.4 TD Intercooler	85	09.91	07.94	- Multi-Link-Achse ²⁾			
	2.8	108	09.90	05.92	- Multi-Link-Achse ²⁾			
	2.8	115	09.90	05.92	- Multi-Link-Achse ²⁾			
	2.9	150	08.90	07.94	- Multi-Link-Achse ²⁾			
	2.0	103	09.90	08.93	+ Multi-Link-Achse ¹⁾	13.0460-2935.2	602935	21385 13,8 / S LUC
	2.0	140	08.90	09.93	+ Multi-Link-Achse ¹⁾			
	2.4 TD Intercooler	85	09.91	07.94	+ Multi-Link-Achse ¹⁾			
	2.8	108	09.90	05.92	+ Multi-Link-Achse ¹⁾			
	2.0	103	09.90	08.93	- Multi-Link-Achse ²⁾	24.0110-0189.1	410189	281 9,6 8,4 +B
	2.0	140	08.90	09.93	- Multi-Link-Achse ²⁾			
	2.4 TD Intercooler	85	09.91	07.94	- Multi-Link-Achse ²⁾			
	2.8	108	09.90	05.92	- Multi-Link-Achse ²⁾			
	2.8	115	09.90	05.92	- Multi-Link-Achse ²⁾			
	2.9	150	08.90	07.94	- Multi-Link-Achse ²⁾			
	2.0	103	09.90	08.93	+ Multi-Link-Achse ¹⁾	24.0110-0206.1	410206	265 10,0 8,0
	2.0	140	08.90	09.93	+ Multi-Link-Achse ¹⁾			
	2.4 TD Intercooler	85	09.91	07.94	+ Multi-Link-Achse ¹⁾			
	2.8	108	09.90	05.92	+ Multi-Link-Achse ¹⁾			
	2.8	115	09.90	05.92	+ Multi-Link-Achse ¹⁾			
	2.9	150	08.90	07.94	+ Multi-Link-Achse ¹⁾			

¹⁾ + multi link axle / + assale Multi-link / + essieu multi-link / + eje Multi-Link

²⁾ - multi link axle / - assale Multi-link / - essieu multi-link / - eje Multi-Link

³⁾ f.predec.13.2381-0067/-0068.2 / p.prece.13.2381-0067.2/-0068.2 / p.préd.13.2381-0067.2/-0068.2





































⁴⁾ f.predec.13.2401-0023/-0024.2 / p.prece.13.2401-0023.2/-0024.2 / p.préd.13.2401-0023.2/-0024.2 / p.prede.13.2401-0023.2/-0024.2

									
VOLVO 960 I Kombi (90-94)									
	2.0	103		09.90	12.91	83.6134-0300.3	330725	2	L=300
	2.0	140		08.90	12.91				
	2.4 TD Intercooler	85		09.91	12.91				
	2.8	108		09.90	12.91				
	2.8	115		09.90	12.91				
2.9	150		08.90	12.91					
	2.0	103		01.92	08.93	83.6124-0305.3	330723	2	L=305
	2.0	140		01.92	09.93				
	2.4 TD Intercooler	85		01.92	07.94				
	2.8	108		01.92	05.92				
	2.8	115		01.92	05.92				
2.9	150		01.92	07.94					
	2.0	103		09.90	08.93	03.0137-0169.2	650169		160 x 25
	2.0	140		08.90	09.93	03.0137-9065.2	669065		Bremsbacken-Zubehör
	2.4 TD Intercooler	85		09.91	07.94				
	2.8	108		09.90	05.92				
	2.8	115		09.90	05.92				
2.9	150		08.90	07.94					
	2.0	103		09.90	08.93	03.0137-0299.2	650299		160 x 25
	2.0	140		08.90	09.93	03.0137-9199.2	669199		Bremsbacken-Zubehör
	2.4 TD Intercooler	85		09.91	07.94				
	2.8	108		09.90	05.92				
	2.8	115		09.90	05.92				
2.9	150		08.90	07.94					
	2.0	103		09.90	08.93	03.6055-0430.3	320065		BR 5/25 (4)
	2.0	140		08.90	09.93				ATE
	2.8	108		09.90	05.92				
	2.8	115		09.90	05.92				
	2.9	150		08.90	07.94				
2.4 TD Intercooler	85		09.91	07.94	03.6055-0431.3	320142		BR 5/35 (4)	
	2.0	103		09.90	08.93	24.2419-0928.3	030056		Gz 19,05
	2.0	140		08.90	09.93				
	2.4 TD Intercooler	85		09.91	07.94				
	2.8	108		09.90	05.92				
	2.8	115		09.90	05.92				
2.9	150		08.90	07.94					
	2.0	103		09.90	08.93	03.2522-0420.3	040086		Nz 22,20
	2.0	140		08.90	09.93				
	2.4 TD Intercooler	85		09.91	07.94				
	2.8	108		09.90	05.92				
	2.8	115		09.90	05.92				
2.9	150		08.90	07.94					
VOLVO 960 II Limousine (94-96)									
	2.5	125		08.94	12.96	03.2023-0875.3	010890		Thz 23,81/20,64 - B.
	2.9	150		08.94	12.96				ATE
	2.5	125		08.94	12.96	24.3571-1707.5	240079		D=57, - Halter
	2.9	150		08.94	12.96	24.3571-1708.5	240080		D=57, - Halter
		150		24.0101-3601.2	260044				Bremsattel-Zubehör
	2.5	125		08.94	12.96	13.0460-2985.2	602985		20164 18,2
	2.9	150		08.94	12.96				LUC
	2.5	125		08.94	12.96	24.0126-0102.1	426102		280 26,0 23,0 V +B
	2.9	150		01.95	12.96				
	2.5	125		08.94	12.96	24.0126-0105.1	426105		280 26,0 23,0 V +B
	2.9	150		08.94	12.94				
	2.5	125		08.94	12.94	83.6134-0335.3	330277	2	L=335
	2.9	150		08.94	12.94				
		150		01.95	12.96	83.6124-0380.3	330268	2	L=380
	2.5	125		08.94	12.96	13.2401-0027.2	210045		D=40
	2.9	150		08.94	12.96	13.2401-0028.2	210046		D=40
150			24.9240-0028.5	230018				D=40	
13.0441-4014.2	250079						für Vorg. 13.2401-0023/-0024.2 ³⁾	Dichtungssatz	
	2.5	125		08.94	12.96	13.0460-3401.2	603401		20755 14,4
	2.9	150		08.94	12.96	13.0460-0088.2	610088		Belagsatz-Zubehör
150			08.94	12.96	13.0460-2935.2	602935		21385 13,8 /S	
	2.5	125		08.94	12.96	24.0110-0189.1	410189		281 9,6 8,4 +B
	2.9	150		08.94	12.96				
150			08.94	12.96	24.0110-0289.1	410289		265 10,0 8,0	
	2.5	125		08.94	12.96	24.0110-0206.1	410206		265 10,0 8,0
	2.9	150		08.94	12.96	83.6134-0300.3	330725	2	L=300
150			08.94	12.96					
	2.5	125		08.94	12.96	03.0137-0299.2	650299		160 x 25
	2.9	150		08.94	12.96	03.0137-9199.2	669199		Bremsbacken-Zubehör
		2.5	125		08.94	12.96	03.6055-0430.3	320065	
	2.9	150		08.94	12.96				ATE

1) - multi link axle / - assale Multi-link / - essieu multi-link / - eje Multi-Link

2) + multi link axle / + assale Multi-link / + essieu multi-link / + eje Multi-Link

3) f.predéc.13.2401-0023/-0024.2 / p.precé.13.2401-0023.2/-0024.2 / p.préd.13.2401-0023.2/-0024.2 / p.prede.13.2401-0023.2/-0024.2

									
VOLVO 960 II Limousine (94-96)									
	2.5	125		08.94	12.96	24.2419-0928.3	030056	Gz 19,05	
	2.9	150		08.94	12.96	24.2419-0941.3	030067	Gz 19,05	
	2.5	125		08.94	12.96	03.2522-0420.3	040086	Nz 22,20	
	2.9	150		08.94	12.96	24.2520-0905.3	040057	Nz 20,64	
VOLVO 960 II Kombi (94-96)									
	2.5	125		08.94	12.96	03.2023-0875.3	010890	THz 23,81/20,64 - B. ATE	
	2.9	150		08.94	12.96				
	2.5	125		08.94	12.96	24.3571-1707.5	240079	D=57, - Halter LUC	
	2.9	150		08.94	12.96	24.3571-1708.5	240080	D=57, - Halter LUC	
	2.5	125		08.94	12.96	24.0101-3601.2	260044	Bremssattel-Zubehör LUC	
	2.9	150		08.94	12.96				
	2.5	125		08.94	12.96	13.0460-2985.2	602985	20164 18,2 LUC	
	2.9	150		08.94	12.96				
	2.5	125		08.94	12.96	24.0126-0102.1	426102	280 26,0 23,0 V +B	
	2.9	150		01.95	12.96				
	2.5	125		08.94	12.94	24.0126-0105.1	426105	280 26,0 23,0 V +B	
	2.9	150		08.94	12.94				
	2.5	125		08.94	12.94	83.6134-0335.3	330277	L=335	
	2.9	150		08.94	12.94				
	2.5	125		01.95	12.96	83.6124-0380.3	330268	L=380	
	2.9	150		01.95	12.96				
	2.5	125		08.94	12.96	- Multi-Link-Achse 1)	13.2401-0027.2	210045	D=40 ATE
	2.9	150		08.94	12.96	- Multi-Link-Achse 1)	13.2401-0028.2	210046	D=40 ATE
	2.5	125		08.94	12.96	- Multi-Link-Achse 1)	24.9240-0028.5	230018	D=40 ATE
	2.9	150		08.94	12.96	- Multi-Link-Achse 1)	13.0441-4014.2	250079	Dichtungssatz ATE
	2.5	125		08.94	12.96	- Multi-Link-Achse 1)	13.0460-3401.2	603401	20755 14,4 ATE
	2.9	150		08.94	12.96	- Multi-Link-Achse 1)	13.0460-0088.2	610088	Belagsatz-Zubehör ATE
	2.5	125		08.94	12.96	+ Multi-Link-Achse 3)	13.0460-2935.2	602935	21385 13,8 /S LUC
	2.9	150		08.94	12.96	+ Multi-Link-Achse 3)			
	2.5	125		08.94	12.96	- Multi-Link-Achse 1)	24.0110-0189.1	410189	281 9,6 8,4 +B
	2.9	150		08.94	12.96	- Multi-Link-Achse 1)			
	2.5	125		08.94	12.96	+ Multi-Link-Achse 3)	24.0110-0289.1	410289	265 10,0 8,0
	2.9	150		08.94	12.96	+ Multi-Link-Achse 3)	24.0110-0206.1	410206	265 10,0 8,0
	2.5	125		08.94	12.96		83.6134-0300.3	330725	L=300
	2.9	150		08.94	12.96				
	2.5	125		08.94	12.96	03.0137-0299.2	650299	160 x 25	
	2.9	150		08.94	12.96	03.0137-9199.2	669199	Bremsbacken-Zubehör	
	2.5	125		08.94	12.96	03.0137-0169.2	650169	160 x 25	
	2.9	150		08.94	12.96	03.0137-9065.2	669065	Bremsbacken-Zubehör	
	2.5	125		08.94	12.96	03.6055-0430.3	320065	BR 5/25 (4) ATE	
	2.9	150		08.94	12.96				
	2.5	125		08.94	12.96	24.2419-0928.3	030056	Gz 19,05	
	2.9	150		08.94	12.96	24.2419-0941.3	030067	Gz 19,05	
	2.5	125		08.94	12.96	03.2522-0420.3	040086	Nz 22,20	
	2.9	150		08.94	12.96	24.2520-0905.3	040057	Nz 20,64	
VOLVO 1800 Sport (68-72)									
	1.8			01.68	12.72	03.2122-1906.3	010761	THz 22,20 - Behälter ATE	
WARTBURG 1,3 (88-91)									
	1.3			10.88	04.91	24.3219-1201.3	020197	Rz 19,05	
WARTBURG 353 (69-88)									
	alle Typen			10.75	09.88	24.3219-1201.3	020197	Rz 19,05	
ZASTAVA 101 (73-93)									
	alle Typen			06.73	12.93	24.3219-0801.3	020181	Rz 19,05 FI	
ZASTAVA 750									
	alle Typen					24.3219-0801.3	020181	Rz 19,05 FI	

1) - multi link axle / - assale Multi-link / - essieu multi-link / - eje Multi-Link

2) f.predec.13.2381-0065/-0066.2 / p.prece.13.2381-0065.2/-0066.2 / p.préd.13.2381-0065.2/-0066.2 / p.prede.13.2381-0065.2/-0066.2

3) + multi link axle / + assale Multi-link / + essieu multi-link / + eje Multi-Link



A large rectangular area containing 30 horizontal lines, intended for writing or drawing.



A large rectangular area containing 30 horizontal lines, intended for writing or drawing.



Ⓓ **Abmessungen Bremsscheiben**

Ⓔ **Dimensions brake discs**

Ⓕ **Dimensions Disques de frein**

Ⓔ **Medidas disco de freno**

Abmessungen Bremsscheiben

Dimensions brake discs - Misure dischi freno -

Dimensions Disques de frein - Medidas disco de freno

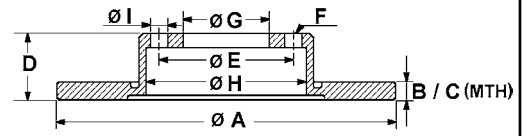

S Fixierschraube - fixing screw - vite di riparazione - vis de fixation - tornillo que fija

B beschichtet - coated - rivestito - revêtu - recubierto

HC hochgekohlt - high carbon - ad alto tenore di carbonio - à haute teneur en carbone - altamente carbonizado

L legiert - alloyed - alligato/legato - allié - aleado

V ventiliert - ventilated - ventilato - ventilé - ventilado

● gelocht - perforated - perforato - poinçonné - perforado

		S	B	H	C	L	V	A	B	C	D	E	F	G	H	I	OE	#
24.0107-0100.1	407100							244,0	7,0	6,3	47,0	108,0	6	86,7	128,0	9,5	CITROEN	95 599 322
24.0107-0104.1	407104							178,0	7,0	6,3	14,5	63,0	4	45,6	85,5	9,4	CITROEN	2G 5 448 826 V 5 448 826
24.0107-0105.2	407105							224,0	7,0	5,0	56,5	108,0	4	71,0	133,0	13,0	CITROEN	95 582 061 95 661 849
24.0107-0108.1	407108							234,0	7,0	6,0	39,5	100,0	4	68,0	140,0	12,8	NISSAN	43206-58Y01
24.0107-0109.1	407109							240,0	7,0	6,0	41,0	100,0	4	61,0	140,0	12,6	NISSAN	43206-5F001
24.0108-0100.1	408100							239,0	8,0	7,0	44,0	100,0	4	65,0	124,5	12,9	AUDI/VW	861 615 301 B
24.0108-0104.1	408104	S	B					238,0	8,2	7,0	41,0	100,0	4	61,0	129,5	12,4	RENAULT	77 01 204 285
24.0108-0105.1	408105							247,5	8,0	6,5	20,3	108,0	4	71,0	133,0	13,0	PEUGEOT	4246 H0
24.0108-0106.1	408106	S	B					247,0	8,0	6,0	25,3	108,0	4	71,1	133,5	13,0	CITROEN	4249 F5
																	PEUGEOT	4249 F5
24.0108-0107.1	408107	S	B					238,0	8,0	6,0	29,0	98,0	3	57,0	124,5	13,0	CITROEN	95 027 199 95 661 810
																	PEUGEOT	4246 G0
24.0108-0108.1	408108		B					238,0	8,0	7,0	74,6	100,0	4	52,0	52,3	M12x1,5	RENAULT	77 00 780 077 77 00 780 078 77 00 829 553 77 01 204 293 77 01 204 294 77 01 204 523 77 01 204 901
24.0108-0109.1	408109							238,0	8,0	7,0	74,6	100,0	4	52,0	52,3	M12x1,5	RENAULT	77 00 805 006 77 00 805 148 77 01 204 302 77 01 204 303
24.0108-0111.1	408111		B					258,0	8,0	7,0	55,3	112,0	5	67,0	164,0	13,0	MERCEDES BENZ	168 423 02 12
24.0108-0113.1	408113	S	B					258,0	8,0	7,0	57,3	112,0	5	67,0	164,0	15,0	MERCEDES BENZ	169 423 09 12
24.0108-0114.2	408114		B					240,0	8,0	7,0	80,6	100,0	4	52,3	55,0	M12x1,5	RENAULT	77 01 207 823 86 60 001 811 86 71 018 106
24.0108-0116.2	408116		B					260,0	8,0	7,0	86,2	114,3	5	52,3	55,0	M12x1,5	RENAULT	43 20 015 39R 43 20 075 95R
24.0108-0117.2	408117		B					238,0	8,0	7,0	74,6	100,0	4	52,3	52,0	M12x1,5	RENAULT	77 01 207 611
24.0108-0118.2	408118		B					260,0	8,0	7,0	86,2	114,3	5	52,3	62,0	M12x1,5	RENAULT	43 20 065 06R 43 20 075 56R
24.0109-0100.2	409100		B					249,0	9,0	7,0	69,2	108,0	4	56,0	62,0	M12x1,25	CITROEN	4249 32
																	PEUGEOT	4249 19 4249 32
24.0109-0101.1	409101							267,0	9,4	7,5	65,3	108,0	4	70,0	160,0	12,8	ALFA ROMEO	60516948
24.0109-0103.1	409103		B					278,0	9,0	7,3	58,5	112,0	5	67,0	164,0	15,0	MERCEDES BENZ	129 423 00 12
24.0109-0108.1	409108							244,5	9,0	7,0	43,8	86,0	3	62,0	109,0	10,0	CITROEN	75 485 825
24.0109-0111.1	409111	S	B					239,0	9,0	8,0	47,6	100,0	4	61,0	155,0	13,0	HONDA	42510-SR3-A11 42510-SR3-J00
24.0109-0114.1	409114	S	B					278,0	9,0	7,3	55,5	112,0	5	67,0	164,0	13,2	CHRYSLER	0 5098 066AA
																	MERCEDES BENZ	203 423 01 12 210 423 01 12 210 423 04 12 210 423 09 12
24.0109-0120.1	409120	S	B					258,0	9,0	7,3	55,5	112,0	5	67,0	164,0	12,8	MERCEDES BENZ	202 423 00 12
24.0109-0121.2	409121							224,0	9,0	8,0	63,2	108,0	5	71,0	135,0	13,0	CITROEN	4246 T3 95 661 814
24.0109-0122.1	409122		B					224,0	9,0	7,0	57,5	108,0	4	71,1	132,7	13,0	CITROEN	95 667 811 E169114
24.0109-0123.1	409123	S	B					230,0	9,0	7,0	40,6	100,0	5	65,0	125,8	15,6	AUDI/SEAT/SKODA/VW	1J0 615 601 C 1J0 615 601 P
24.0109-0124.1	409124		B					232,0	9,0	7,0	39,5	100,0	4	65,0	125,0	13,6	SEAT/VW	6N0 615 601 A 6N0 615 601 B
24.0109-0125.1	409125							228,0	9,0	8,0	39,5	100,0	4	60,0	127,0	13,5	VOLVO	3432618 3450386
24.0109-0127.1	409127							231,0	9,0	8,0	34,5	100,0	4	65,0	125,0	13,0	MAZDA	B4Y2-26-251C
24.0109-0128.1	409128							242,0	9,0	8,0	36,4	100,0	4	54,0	130,9	14,5	TOYOTA	42431-12090 42431-12120
24.0109-0129.1	409129							258,0	9,0	8,0	44,5	114,3	4	68,0	154,0	12,8	NISSAN	43206-42R05
24.0109-0130.1	409130							258,0	9,0	7,5	43,5	108,0	4	68,0	160,7	15,5	SAAB	8970717
24.0109-0131.1	409131		B					251,0	9,0	8,0	34,5	100,0	4	55,0	125,0	13,0	MAZDA	BB4C-26-251C BR74-26-251A
24.0109-0132.1	409132							282,0	9,0	7,5	61,0	114,3	5	70,0	170,0	12,6	HONDA	42510-SP0-000 42510-SX0-000
24.0109-0133.1	409133	S	B					239,0	8,9	7,0	33,4	100,0	5	65,0	132,5	15,8	AUDI/VW/SKODA	1J0 615 601 D
24.0109-0136.1	409136		B	HC				280,0	9,0	8,0	38,0	112,0	3	58,0	153,5	12,5	SMART	000 4341 V002 000000



Abmessungen Bremsscheiben

Dimensions brake discs - Misure dischi freno -

Dimensions Disques de frein - Medidas disco de freno

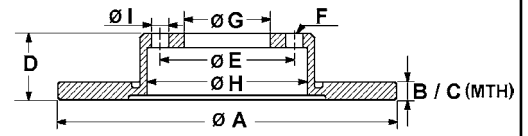

S Fixierschraube - fixing screw - vite di riparazione - vis de fixation - tornillo quefija

B beschichtet - coated - rivestito - revêtu - recubierto

HC hochgekohlt - high carbon - ad alto tenore di carbonio - à haute teneur en carbone - altamente carbonizado

L legiert - alloyed - alligato/legato - allié - aleado

V ventiliert - ventilated - ventilato - ventilé - ventilado

● gelocht - perforated - perforato - poinçonné - perforado

		S	B	HC	L	V	A	B	C	D	E	F	G	H	I	OE	#
24.0109-0137.1	409137	S	B				247,0	9,0	8,0	35,0	108,0	4	71,1	133,0	13,0	CITROEN	4246 X8 4259 53 4249 90
																PEUGEOT	4246 W9 4259 52 4249 90
24.0109-0138.1	409138		B				258,0	9,0	8,0	55,5	100,0	4	55,0	172,0	14,5	TOYOTA	42431-02070
24.0109-0139.1	409139		B				269,0	9,0	8,0	56,0	100,0	4	55,0	173,0	14,5	TOYOTA	42431-12250 42431-52050 42431-47020
24.0109-0140.1	409140		B				279,0	9,0	8,0	55,5	100,0	4	55,0	172,0	14,5	TOYOTA	42431-02080 42431-02081
24.0109-0141.1	409141	S					260,0	9,0	8,0	42,3	114,3	4	64,1	157,0	12,6	HONDA	42510-S30-900
24.0109-0142.1	409142		B				278,0	9,0	7,0	24,7	100,0	4	55,0	147,0	14,3	DAIHATSU	42431-0D060
																TOYOTA	42431-0D060
24.0109-0143.1	409143	S					260,0	9,0	8,0	48,2	100,0	4	61,0	156,0	13,0	HONDA	42510-S5A-A00
24.0109-0144.1	409144		S				282,0	9,0	8,0	58,3	114,3	5	64,1	170,0	12,5	HONDA	42510-S9A-N00
24.0109-0145.1	409145		S				260,0	9,0	8,0	48,1	114,3	4	64,1	157,0	12,6	HONDA	42510-S84-A50
24.0109-0146.1	409146		B				270,0	9,0	7,3	53,3	100,0	5	57,5	172,0	14,5	CHRYSLER	4509 553 4509 553AB 4509 553AC
24.0109-0147.1	409147						258,0	9,0	8,0	46,5	114,3	5	68,0	154,0	12,5	NISSAN	43206-74F00
24.0109-0148.1	409148						269,0	9,0	8,0	65,0	100,0	5	55,0	170,0	14,5	TOYOTA	42431-20360
24.0109-0150.2	409150		B				249,0	9,0	8,0	67,1	108,0	4	55,9	60,0	M12x1,25	CITROEN	4246 Z9 4249 34 4246 Z9
																PEUGEOT	
24.0109-0151.1	409151	S	B				304,5	9,0	7,5	61,0	114,3	5	64,1	200,0	12,8	HONDA	42510-SCA-E50
24.0109-0152.1	409152		B				303,0	9,0	8,0	62,1	114,3	5	62,0	190,0	14,5	TOYOTA	42431-42041
24.0109-0154.1	409154	S	B				278,0	9,0	7,3	57,5	112,0	5	67,0	164,0	15,0	MERCEDES BENZ	000 423 13 12
24.0109-0155.1	409155		B				259,0	9,0	7,5	30,5	114,3	5	62,0	156,0	14,8	TOYOTA	42431-02190 42431-12260
24.0109-0156.1	409156		B				259,0	9,0	7,5	30,0	100,0	4	55,0	156,0	14,5	ASTON MARTIN	42431-52080
																TOYOTA	42431-52080
24.0109-0157.1	409157		B				291,5	9,0	8,0	62,0	114,3	5	68,0	172,0	12,7	NISSAN	43206-JD00A
24.0109-0158.1	409158	S	B				260,0	9,0	8,0	42,2	114,3	5	64,2	140,5	12,6	HONDA	42510-SMG-E20 42510-SNA-A00
24.0109-0159.1	409159		B				266,0	9,0	8,0	36,2	100,0	4	55,0	131,0	14,5	TOYOTA	42431-12150 42431-12170
24.0109-0160.1	409160		B				278,0	9,0	8,0	43,1	114,3	5	62,0	169,0	12,7	SUZUKI	55611-80J10
24.0109-0161.1	409161		B				282,0	9,0	7,5	61,1	114,3	5	64,2	170,0	12,6	HONDA	42510-SZ3-J00
24.0109-0162.1	409162	S	B				260,0	9,0	8,0	31,1	100,0	4	61,0	142,4	12,6	HONDA	42510-TM8-G00
24.0109-0163.1	409163		B				259,0	9,0	7,5	30,2	100,0	5	55,0	156,2	14,5	SUBARU	4243112310
																TOYOTA	42431-12310
24.0109-0166.1	409166		B				292,0	9,0	8,0	62,0	114,3	4	68,0	172,0	12,5	NISSAN	43206-EM10A
24.0109-0167.1	409167		B				278,0	9,0	8,0	43,2	114,3	5	62,0	169,0	14,0	FIAT	71768089
																SUZUKI	55611-55L00 55611-80J01
24.0109-0169.1	409169	S	B				282,0	9,0	8,0	48,7	114,3	5	64,2	157,0	12,5	HONDA	42510-TA0-A01
24.0109-0170.1	409170		B				259,0	9,0	7,5	40,8	100,0	5	55,0	156,0	16,5	TOYOTA	42431-52150
24.0109-0171.2	409171		B				249,0	9,0	8,0	73,2	108,0	4	56,0	62,0	M12x1,25	CITROEN/PEUGEOT	4249 66
24.0109-0173.1	409173	S	B	HC			276,0	9,0	7,3	44,0	112,0	5	67,0	153,0	15,0	MERCEDES BENZ	246 423 04 12
24.0109-0174.1	409174	S	B				232,0	9,0	7,0	39,6	100,0	5	65,0	123,8	15,6	VOLKSWAGEN	1JE 615 601
24.0109-0182.1	409182		B				259,4	9,0	8,0	43,2	114,3	5	62,0	146,6	14,0	SUZUKI	55611-61M00
24.0109-0709.1	409709						260,0	9,0	8,0	48,1	114,3	5	64,1	157,0	12,6	HONDA	42510-S87-A00
24.0109-0711.1	409711		B				269,0	9,0	7,5	56,0	100,0	5	55,0	173,0	14,5	TOYOTA	42431-20420 42431-47030
24.0110-0109.1	410109						240,0	10,0	8,4	58,5	80,0	4	63,0	106,0	10,2	BMW	34 11 1 117 422
24.0110-0110.1	410110						272,0	9,5	7,9	61,5	120,0	5	75,0	160,0	14,5	BMW	34 21 1 163 305
24.0110-0111.1	410111		B				226,0	10,0	8,0	71,2	100,0	4	39,8	121,4	M12x1,5	SEAT/VW	357 615 601
																VOLKSWAGEN	6N0 615 601
24.0110-0115.1	410115		B				253,0	10,2	8,9	33,0	108,0	4	63,5	155,0	13,7	FORD	1514237 1756882 1780880 4083484 5022666 5030658 95GJ-2A315-EC C1BC-2A315-AA
24.0110-0116.1	410116		B				245,0	10,0	8,0	46,5	112,0	5	68,0	135,5	15,4	AUDI	443 615 601 B
24.0110-0117.1	410117	S	B	HC			300,0	10,0	8,4	61,0	120,0	5	75,0	180,0	14,5	BMW	34 21 1 162 305
24.0110-0118.1	410118		B	HC			300,0	9,9	8,4	67,9	120,0	5	75,0	180,0	14,5	BMW	34 21 1 165 259
24.0110-0136.1	410136						215,0	10,0	8,0	33,0	102,0	4	86,0	106,0	M10x1,25	SUZUKI	55511-82001
24.0110-0139.1	410139						228,0	10,0	9,0	38,5	99,0	6	83,0	102,5	M8	RENAULT	77 01 466 540

Abmessungen Bremsscheiben

Dimensions brake discs - Misure dischi freno -

Dimensions Disques de frein - Medidas disco de freno

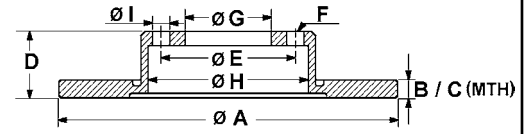

S Fixierschraube - fixing screw - vite di riparazione - vis de fixation - tornillo quefija
 B beschichtet - coated - rivestito - revêtu - recubierto
 HC hochgekohlt - high carbon - ad alto tenore di carbonio - à haute teneur en carbone - altamente carbonizado
 L legiert - alloyed - alligato/legato - allié - aleado
 V ventiliert - ventilated - ventilato - ventilé - ventilado
 ● gelocht - perforated - perforato - poinçonné - perforado

		S	B	HC	L	V	A	B	C	D	E	F	G	H	I	OE - #
24.0110-0142.1	410142						278,0	9,5	8,0	83,8	130,0	4	39,8	160,0	M14x1,5	VOLKSWAGEN 113 407 075 311 405 583 A
24.0110-0144.1	410144						261,0	9,9	8,0	82,1	100,0	4	39,8	160,0	M12x1,5	OPEL/VAUXHALL 5 69 204/90348319
24.0110-0147.1	410147						280,0	10,0	8,4	68,1	120,0	5	75,0	160,0	14,5	BMW 34 21 1 165 255
24.0110-0148.1	410148						221,0	10,0	8,7	42,0	108,0	4	72,0	131,0	13,4	FORD 1575877 5022650 5022651 6119634
24.0110-0150.1	410150	B					258,0	10,0	8,4	60,0	100,0	4	62,0	160,8	14,5	BMW 34 21 6 755 407
24.0110-0151.1	410151	S B					239,0	10,0	8,0	38,9	100,0	4	65,0	124,5	13,6	AUDI/SEAT/VW 811 615 301
24.0110-0152.1	410152	S					236,0	10,0	7,0	41,0	100,0	4/6	60,0	123,0	14,0	OPEL/VAUXHALL 5 69 028/90008003
24.0110-0154.1	410154						245,0	10,0	8,0	59,5	112,0	5	68,0	135,8	15,4	AUDI 437 615 601
24.0110-0166.1	410166						250,0	9,9	8,0	21,0	80,0	6	62,0	134,0	8,5	ALFA ROMEO 60526121
24.0110-0174.1	410174						284,0	10,0	8,4	61,0	120,0	5	75,0	180,0	14,5	BMW 34 21 1 162 968
24.0110-0176.1	410176						284,0	10,0	8,4	68,0	120,0	5	75,0	180,0	14,5	BMW 34 21 1 163 150
24.0110-0178.1	410178	B					245,0	10,0	8,0	59,5	108,0	4	68,0	135,8	15,4	AUDI 443 615 601
24.0110-0179.1	410179						250,0	9,9	8,0	21,0	80,0	6	62,0	134,0	10,5	ALFA ROMEO 60533971
24.0110-0181.1	410181						259,0	10,0	8,0	72,0	114,3	5	48,0	58,0	12,5	FORD E92Z2C026A MAZDA GJ25-26-251 GJ25-26-251A GJ25-26-251B GW55-26-251
24.0110-0182.1	410182	B					245,0	10,0	8,0	40,1	108,0	4	68,0	135,5	15,4	AUDI 8A0 615 601
24.0110-0183.1	410183						266,0	10,0	8,0	27,0	108,0	4	66,0	133,2	13,0	CITROEN PEUGEOT 4246 A9
24.0110-0185.1	410185	S B					279,0	10,0	8,3	71,7	112,0	5	67,0	160,0	15,0	MERCEDES BENZ 126 423 00 12
24.0110-0186.1	410186						252,7	10,2	8,9	33,0	112,0	5	63,5	155,0	13,7	FORD 5027464 5027465
24.0110-0187.1	410187	S B					247,0	10,0	9,0	34,2	108,0	4	66,0	133,0	13,0	CITROEN PEUGEOT 95 661 748 4246 A5 4249 95
24.0110-0189.1	410189	B					281,0	9,6	8,4	73,2	108,0	5	68,0	160,0	16,5	VOLVO 270736
24.0110-0190.1	410190	B					251,5	10,0	9,0	50,7	98,0	4	59,0	127,5	13,0	ALFA/FIAT/LANCIA 46758715 46831042 82434070 71738913
24.0110-0191.1	410191	B					270,0	10,0	8,0	67,0	110,0	5	65,5	160,0	14,0	OPEL/VAUXHALL 5 69 101/90272328
24.0110-0192.1	410192						289,8	10,0	9,0	46,0	140,0	5	107,0	177,0	13,0	SUZUKI 55211-80000
24.0110-0193.1	410193						239,5	10,2	8,7	58,1	108,0	4	63,5	136,0	13,7	FORD 5022947 5024744
24.0110-0196.1	410196	B					239,7	10,0	8,0	43,0	108,0	4	63,6	136,0	13,8	FORD 5022652 5022653
24.0110-0197.1	410197						238,0	10,0	9,0	29,0	98,0	3	57,0	124,3	12,8	CITROEN 95 638 635 95 661 848
24.0110-0198.1	410198						258,0	10,0	9,0	29,0	98,0	3	57,0	124,3	13,0	CITROEN 95 669 226
24.0110-0199.1	410199						247,0	10,0	8,0	34,3	108,0	4	71,0	133,0	13,0	PEUGEOT 4246 G9
24.0110-0200.1	410200						245,0	10,0	8,0	65,5	108,0	4	68,0	135,5	15,4	AUDI 443 615 601 E
24.0110-0201.1	410201	B					245,0	10,0	8,0	64,2	112,0	5	68,0	135,5	15,4	AUDI/SKODA/VW 4A0 615 601 A
24.0110-0202.1	410202	S B HC					280,0	10,0	8,4	60,0	120,0	5	75,0	160,8	14,5	BMW 34 21 1 165 457 34 21 6 864 051
24.0110-0203.1	410203	B					226,0	10,0	8,0	71,2	100,0	5	39,8	50,2	M14x1,5	SEAT/VW 357 615 601 B
24.0110-0204.1	410204	B					260,0	10,0	8,0	69,2	100,0	4	57,0	160,0	14,0	OPEL/VAUXHALL 5 69 206/90421872
24.0110-0205.1	410205	B					270,0	9,9	8,0	77,0	100,0	4	57,0	160,0	14,0	OPEL/VAUXHALL 5 69 102/90297932
24.0110-0206.1	410206						265,0	10,0	8,0	53,0	108,0	5	68,0	160,0	16,0	VOLVO 1359290
24.0110-0207.1	410207						245,0	10,0	8,0	46,5	108,0	4	68,0	135,5	15,4	AUDI 443 615 601 A
24.0110-0208.1	410208						247,0	10,0	9,0	32,5	98,0	3	57,0	124,5	13,0	CITROEN 95 661 811 96 047 276
24.0110-0209.1	410209	B					251,4	10,0	9,0	50,5	98,0	5	59,0	127,5	13,0	ALFA/FIAT/LANCIA 7789267 60569164 60653479 71738912 60801787 82439939 82440275
24.0110-0210.1	410210	B					245,0	10,0	8,0	83,6	112,0	5	45,2	135,5	M14x1,5	AUDI 8D0 615 601 B
24.0110-0211.1	410211	S B HC					272,0	10,0	8,4	78,0	120,0	5	75,0	160,8	14,5	BMW 34 21 6 758 552 34 21 6 758 553
24.0110-0212.1	410212	S B					238,5	10,0	8,0	48,1	100,0	4	61,0	154,5	13,0	HONDA 42510-SE0-010 42510-SH3-G00 42510-SK3-305 42510-SK3-E00
24.0110-0213.1	410213						270,0	10,0	8,6	62,6	108,0	4	63,5	180,0	13,7	ROVER GBD90817 EGP1254 FORD 5025951



Abmessungen Bremsscheiben

Dimensions brake discs - Misure dischi freno -

Dimensions Disques de frein - Medidas disco de freno

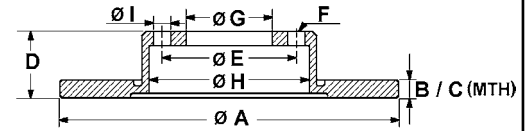

S Fixierschraube - fixing screw - vite di riparazione - vis de fixation - tornillo quefija

B beschichtet - coated - rivestito - revêtu - recubierto

HC hochgekohlt - high carbon - ad alto tenore di carbonio - à haute teneur en carbone - altamente carbonizado

L legiert - alloyed - alligato/legato - allié - aleado

V ventiliert - ventilated - ventilato - ventilé - ventilado

• gelocht - perforated - perforato - poinçonné - perforado

		S	B	HC	L	V	A	B	C	D	E	F	G	H	I	OE - #		
24.0110-0214.1	410214	B					295,0	9,6	8,4	72,0	108,0	5	68,0	178,0	14,5	VOLVO	271794	
24.0110-0215.1	410215	B					258,0	10,0	9,0	45,0	114,3	4	68,0	154,0	12,6	NISSAN	43206-99J01	
24.0110-0216.1	410216						295,0	9,6	8,4	72,0	108,0	4	68,0	178,0	14,5	VOLVO	271497	
24.0110-0217.1	410217	S B					290,0	10,0	8,3	55,5	112,0	5	67,0	164,0	13,3	MERCEDES BENZ	210 423 10 12	
24.0110-0218.1	410218	B					295,0	10,0	8,0	56,0	98,0	5	59,0	180,0	15,0	CITROEN	4246 J6	
																FIAT/LANCIA	9566928380	
																PEUGEOT	4246 J5	
24.0110-0219.1	410219	B					265,0	10,5	9,5	44,3	100,0	4	66,0	149,6	13,5	RENAULT	77 01 205 844	
																	86 71 005 980	
24.0110-0220.1	410220	B					265,0	10,5	9,5	44,3	108,0	5	66,0	149,6	14,5	RENAULT	77 01 205 845	
																	86 71 005 979	
24.0110-0223.1	410223	S B					268,0	10,0	8,0	45,8	112,0	5	68,2	154,5	16,8	FORD	1001094	
																	1045995	
24.0110-0224.1	410224	B					245,0	10,0	8,0	48,0	112,0	5	68,0	135,5	15,4	SEAT/VW	7M0 615 601 C	
																AUDI/VW	8D0 615 601 A	
																	8E0 615 601 A	
24.0110-0225.1	410225	S B					270,0	10,0	8,0	69,3	100,0	4	57,0	160,0	14,0	OPEL/VAUXHALL	5 69 209/90512909	
24.0110-0226.1	410226	S B					286,0	10,0	8,0	69,3	110,0	5	65,5	160,0	14,0	OPEL/VAUXHALL	5 69 210/90512910	
																	4565693	
																	5391578	
24.0110-0227.1	410227	S B	HC				298,0	10,0	8,4	61,0	120,0	5	75,0	185,0	14,5	BMW	34 21 1 163 835	
																	34 21 6 767 049	
24.0110-0228.1	410228	S B	HC	L			280,0	10,0	8,0	65,2	112,0	5	67,0	178,0	15,0	MERCEDES BENZ	638 423 01 12	
24.0110-0229.1	410229	B					260,0	10,0	8,4	41,0	114,3	4	90,0	154,0	12,6	MITSUBISHI	MB699288	
																	MR249356	
																	MR913846	
24.0110-0230.1	410230	B					290,5	10,0	8,0	60,0	108,0	4	71,0	185,0	13,0	VOLVO	30872940	
																PEUGEOT	4246 L7	
																	4246 T6	
																	4246 T7	
24.0110-0231.1	410231						290,0	10,0	8,0	40,0	108,0	5	71,0	185,0	13,0	PEUGEOT	4246 F1	
																	4246 K9	
24.0110-0232.1	410232	S B					239,0	9,9	8,0	33,6	100,0	4	65,0	125,0	13,8	SEAT/VW	6N0 615 301	
24.0110-0233.1	410233	S B					260,0	10,0	8,0	48,7	114,3	4	64,1	155,0	12,8	HONDA	42510-SN7-000	
																	42510-SV1-A00	
																	42510-SV4-A00	
24.0110-0234.1	410234	B					261,0	10,0	8,0	40,0	114,3	5	72,0	142,5	13,0	ROVER	GBD90835	
																FORD	3415598	
																MAZDA	GA5Y-26-251C	
																	GA5Y-26-251D	
																	GA7Y-26-251	
																	GA8Y-26-251	
																	GTYF-26-251C	
24.0110-0235.1	410235						211,0	10,0	9,0	35,0	88,0	4	70,0	98,0	M10x1,25	DAIHATSU	43512-87216-000	
24.0110-0237.1	410237	B					266,0	10,0	8,5	65,8	100,0	5	58,0	170,0	12,8	SUBARU	26310AA051	
																	26700FE010	
																	26710AC020	
																	26700FE080	
24.0110-0238.1	410238						265,0	10,0	8,4	49,0	114,3	4	90,0	154,0	12,6	MITSUBISHI	MB500555	
																	MB500556	
24.0110-0239.1	410239						213,5	9,6	8,6	61,2	73,0	4	55,6	85,0	3/8"	AUSTIN/ROVER	GBD90806	
24.0110-0240.1	410240						262,0	10,0	8,4	60,1	114,3	4	90,0	168,0	12,6	MITSUBISHI	MB668083	
																	MB857978	
24.0110-0241.1	410241						269,0	10,0	9,0	64,5	100,0	5	54,0	188,5	14,5	TOYOTA	42431-20160	
24.0110-0242.1	410242	B					290,0	10,0	8,0	46,2	139,5	5	107,0	182,5	13,0	SUZUKI	55211-60A00	
24.0110-0243.1	410243						265,0	10,0	8,4	49,0	114,3	5	90,0	154,0	12,6	MITSUBISHI	MB587433	
24.0110-0244.1	410244						258,0	10,0	9,0	45,0	114,3	5	68,0	154,0	12,6	NISSAN	43206-88E03	
24.0110-0249.1	410249						260,0	10,0	8,0	69,2	110,0	5	65,5	160,0	14,3	OPEL/VAUXHALL	5 69 105/90509590	
																	SAAB	4241477
24.0110-0250.1	410250	S B					264,0	9,8	8,0	42,0	110,0	5	65,5	145,0	14,0	OPEL/VAUXHALL	5 69 109/9117772	
24.0110-0251.1	410251	S B					240,0	9,8	8,0	42,0	100,0	4	57,0	140,8	14,0	OPEL/VAUXHALL	5 69 111/9196587	
24.0110-0253.1	410253						270,0	10,0	8,0	77,0	110,0	5	65,5	160,1	12,8	OPEL/VAUXHALL	5 69 207/90442651	
24.0110-0255.1	410255						260,0	10,0	8,0	43,1	114,3	4	64,1	158,8	12,5	HONDA	42510-SG9-000	
																	42510-SG9-010	
24.0110-0256.1	410256						259,0	10,0	8,0	72,0	114,3	5	47,9	63,9	12,5	ROVER	GBD90802	
																MAZDA	G311-26-251A	
																	GM09-26-251B	
24.0110-0258.1	410258	B					245,0	10,0	8,0	54,1	112,0	5	68,0	135,5	15,3	AUDI	4B0 615 601	
24.0110-0259.1	410259	B					255,0	10,0	8,0	54,1	112,0	5	68,0	144,5	15,3	AUDI	4B0 615 601 A	
24.0110-0260.1	410260	B					255,0	10,0	8,0	48,1	112,0	5	68,0	144,5	15,3	AUDI	4B0 615 601 B	
24.0110-0261.1	410261	B					245,0	10,0	8,0	40,0	112,0	5/9	68,0	135,5	15,3	AUDI	8E0 615 601 B	
																	8E0 615 601 P	
24.0110-0262.1	410262						300,0	10,0	8,4	95,0	120,0	5	75,0	180,0	14,5	BMW	34 21 1 158 576	
24.0110-0263.1	410263						258,0	10,0	8,4	74,5	100,0	4	62,0	161,0	14,5	BMW	34 21 1 163 145	

Abmessungen Bremsscheiben

Dimensions brake discs - Misure dischi freno -

Dimensions Disques de frein - Medidas disco de freno

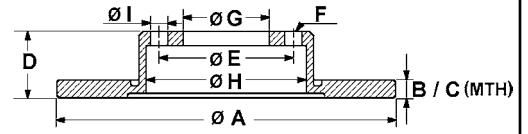

S Fixierschraube - fixing screw - vite di riparazione - vis de fixation - tornillo quefija
 B beschichtet - coated - rivestito - revêtu - recubierto
 HC hochgekohlt - high carbon - ad alto tenore di carbonio - à haute teneur en carbone - altamente carbonizado
 L legiert - alloyed - alligato/legato - allié - aleado
 V ventiliert - ventilated - ventilato - ventilé - ventilado
 ● gelocht - perforated - perforato - poinçonné - perforado

		S	B	HC	L	V	A	B	C	D	E	F	G	H	I	OE - #	
24.0110-0264.1	410264		B				258,0	10,0	8,0	40,4	114,3	4	76,0	154,0	12,6	HYUNDAI	58411-29310
24.0110-0266.1	410266						236,0	10,0	8,4	41,0	100,0	4	64,0	144,0	12,6	mitsubishi	MB857763 MR249357
24.0110-0267.1	410267						260,0	10,0	8,0	43,2	114,3	4	64,1	159,0	12,6	HONDA	42510-SD4-000 42510-SS0-000 42510-SS0-J00
24.0110-0268.1	410268		B				240,0	10,2	8,2	40,5	100,0	4	57,0	126,0	14,0	OPEL/VAUXHALL	5 69 112/9196592
24.0110-0269.1	410269		B				261,0	10,0	8,0	39,9	100,0	4	55,0	124,3	13,0	MAZDA	B26Y-26-251
24.0110-0270.1	410270		B				280,0	10,0	8,0	61,9	100,0	5	64,0	161,0	15,0	ROVER	GBD90847 SDB000870 SDB101100
24.0110-0271.1	410271		B				259,0	10,0	8,4	44,1	100,0	4	64,2	163,0	16,0	MINI	34 21 1 503 070 34 21 6 774 987
24.0110-0272.1	410272						290,0	10,0	8,0	51,0	108,0	5	71,0	185,0	13,0	PEUGEOT	4246 V7
24.0110-0273.1	410273		S	B	HC		272,0	10,0	8,4	83,0	120,0	5	75,0	161,0	14,5	BMW	34 21 6 794 298
24.0110-0274.1	410274		S	B			286,0	10,0	8,0	69,0	110,0	5	65,5	160,0	14,0	SAAB	5391537 12763591
24.0110-0275.2	410275						226,0	10,0	8,0	71,5	100,0	4	39,9	121,5	M12x1,5	SEAT/VW	357 615 601
24.0110-0276.2	410276						226,0	10,0	8,0	71,5	100,0	5	39,9	121,5	M14x1,5	VOLKSWAGEN	6N0 615 601
24.0110-0277.1	410277		S	B			253,0	10,0	8,0	51,6	112,0	5/9	65,0	140,0	15,3	SEAT/VW	357 615 601 B
24.0110-0278.1	410278		S	B			300,0	10,0	8,3	68,3	112,0	5	67,0	180,0	15,3	AUDI/SEAT/SKODA/VW	1K0 615 601 K 1K0 615 601 AB 5C0 615 601
24.0110-0279.1	410279		S	B			260,0	10,0	8,0	48,7	114,3	5	64,2	157,0	12,6	MERCEDES BENZ	000 423 10 12 211 423 07 12
24.0110-0280.1	410280		S	B			296,0	10,0	8,0	57,7	112,0	5	67,0	186,0	15,0	HONDA	42510-S5T-E00
24.0110-0281.1	410281						262,0	9,5	8,4	60,1	114,3	5	90,0	168,0	12,6	MERCEDES BENZ	639 423 01 12
24.0110-0282.1	410282						258,0	10,3	8,0	64,7	114,3	5	57,0	168,0	13,0	MITSUBISHI	MR493489
24.0110-0283.1	410283		B				276,0	10,0	9,0	45,7	98,0	5	59,0	138,0	13,2	DAEWOO	96219485
24.0110-0284.1	410284		B				271,0	10,0	9,0	60,7	100,0	5	55,0	151,0	14,5	ALFA ROMEO	46469908 46542702
24.0110-0285.1	410285		B				278,0	10,0	9,0	45,0	114,3	5	68,0	154,0	12,5	TOYOTA	42431-05040
24.0110-0286.1	410286		B				284,0	10,0	8,4	61,0	114,3	5	76,0	190,0	12,6	NISSAN	43206-4U101 43206-4U103
24.0110-0287.1	410287		S	B	HC		280,0	10,0	8,4	75,0	120,0	5	75,0	160,8	14,7	HYUNDAI	58411-2Y300 58411-3A300 58411-3A300
24.0110-0289.1	410289						265,0	10,0	8,0	71,0	108,0	5	68,0	160,1	16,0	KIA	34 21 6 766 225
24.0110-0290.1	410290		B				276,0	10,0	9,0	51,5	108,0	5	59,0	138,0	14,7	BMW	34 21 6 794 306 271895
24.0110-0291.1	410291		S	B			264,0	10,0	8,0	42,0	100,0	4	57,0	145,0	14,0	VOLVO	71739570
24.0110-0292.1	410292						283,0	10,0	8,0	62,0	108,0	5	68,0	190,0	16,0	OPEL/VAUXHALL	5 69 116/93176548
24.0110-0293.1	410293		B	HC	L		290,0	10,0	8,3	57,0	112,0	5	67,0	164,0	13,2	VOLVO	272248
24.0110-0295.1	410295		B				260,0	10,0	8,0	63,7	114,3	4	64,1	155,0	12,7	MERCEDES BENZ	129 423 04 12
24.0110-0298.1	410298		B				258,0	10,0	8,0	45,3	114,3	5	76,0	154,0	12,6	HONDA	42510-S1A-E10
24.0110-0299.1	410299						305,0	10,0	8,5	75,2	127,0	5	72,2	194,5	15,5	HYUNDAI	58411-2C000
24.0110-0300.1	410300						270,0	10,0	8,0	61,0	100,0	4	57,0	180,0	13,0	JEEP	5209 8666
24.0110-0301.1	410301		B				261,0	10,0	8,0	39,9	100,0	4	57,0	142,8	13,0	KIA	0K20H-26-251
24.0110-0302.1	410302		B				280,0	10,0	8,0	40,2	114,3	5	72,0	142,0	13,0	KIA	0K2AA-26-251B
24.0110-0304.1	410304		B				250,0	10,0	8,0	38,6	114,3	4	69,0	147,0	12,6	MAZDA	GF3Y-26-251A GFYY-26-251 N123-26-251 N123-26-251A NF47-26-251
24.0110-0305.1	410305		B				288,0	10,0	8,5	64,9	100,0	5	55,0	170,0	14,5	MITSUBISHI	4605A076
24.0110-0307.1	410307						276,0	10,0	8,0	34,9	100,0	4	55,0	125,0	13,0	SMART	454 420 00 72
24.0110-0308.1	410308		S	B			261,0	10,0	8,0	40,0	114,3	4	72,0	142,5	13,0	TOYOTA	42431-20430
24.0110-0310.1	410310		B				278,0	10,0	9,0	45,0	114,3	4	68,0	154,0	12,6	MAZDA	N06Y-26-251B N0YY-26-251B
24.0110-0311.1	410311		B				280,0	10,0	9,0	56,0	100,0	5	55,0	173,0	14,7	KIA	0K9AA-26-251 0K9AA-26-251A 0K9AA-26-251B 0K9AA-26-251C
24.0110-0312.1	410312		B				262,0	10,0	8,4	64,0	100,0	4	62,5	168,0	12,6	NISSAN	43206-99J04
24.0110-0313.1	410313						280,0	10,2	8,9	33,0	108,0	4	63,5	155,0	13,7	TOYOTA	42431-05030
24.0110-0314.1	410314		S	B	HC		280,0	10,0	8,4	65,5	120,0	5	75,0	160,8	14,5	HYUNDAI/KIA	58411-1C800
24.0110-0315.1	410315		S	B	HC		296,0	10,4	8,9	65,5	120,0	5	75,0	160,8	14,5	FORD	4411312
24.0110-0316.1	410316		B				288,0	10,0	8,5	69,8	114,3	5	62,0	190,0	14,5	BMW	34 21 6 855 001 34 21 4 031 725 34 21 6 764 649 34 21 6 855 002
																LEXUS	42431-48041



Abmessungen Bremsscheiben

Dimensions brake discs - Misure dischi freno -

Dimensions Disques de frein - Medidas disco de freno

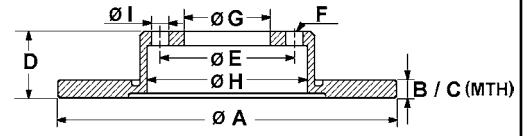

S Fixierschraube - fixing screw - vite di riparazione - vis de fixation - tornillo quejija L legiert - alloyed - alligato/legato - allié - aleado ● gelocht - perforated - perforato - poinçonné - perforado
 B beschichtet - coated - rivestito - revêtu - recubierto V ventiliert - ventilated - ventilato - ventilé - ventilado
 HC hochgekohlt - high carbon - ad alto tenore di carbonio - à haute teneur en carbone - altamente carbonizado

		S	B	HC	L	V	A	B	C	D	E	F	G	H	I	OE	#
24.0110-0317.1	410317						262,0	10,0	8,4	61,0	114,3	4	76,0	168,0	12,8	HYUNDAI	58411-38310
24.0110-0318.1	410318	B					262,0	10,0	8,4	61,0	114,3	5	76,0	168,0	12,6	HYUNDAI	58411-39600
24.0110-0319.1	410319						295,0	10,0	8,8	88,0	120,7	5	73,8	180,0	13,4	KIA	58411-39600
24.0110-0320.1	410320	B					290,0	10,0	8,5	56,8	114,3	5	62,0	180,0	14,5	JAGUAR	JLM 10601
24.0110-0321.1	410321	B					260,0	10,0	8,0	49,0	114,3	5	64,2	140,4	12,6	JLM 12424	JLM 1830
24.0110-0323.1	410323	B					264,0	10,0	8,0	40,5	100,0	4/6	60,0	136,8	14,0	TOYOTA	42431-0F010
24.0110-0324.1	410324	B					234,0	10,0	8,0	37,5	100,0	4	62,5	142,0	12,6	HONDA	42510-SEA-E00
24.0110-0325.2	410325	B					270,0	10,0	9,0	80,7	100,0	4	55,0	52,3	M12x1,5	42510-SEA-E50	
24.0110-0326.1	410326						260,0	10,0	8,0	48,5	100,0	4	61,0	148,5	12,6	FIAT	55700592
24.0110-0328.1	410328	S	B				300,0	10,0	8,3	57,5	112,0	5	67,0	164,0	15,3	OPEL	5 69 097/93167282
24.0110-0329.1	410329	S	B				302,0	10,0	8,0	61,0	114,3	5	64,1	200,0	12,5	HYUNDAI	58411-0X500
24.0110-0330.1	410330	B					302,0	10,0	8,4	58,7	114,3	5	80,0	190,0	12,6	KIA	58411-07300
24.0110-0331.1	410331	B	HC				280,0	9,6	8,0	38,0	112,0	3	58,0	153,5	12,5	58411-07500	58411-07500
24.0110-0332.1	410332	B					262,0	10,0	8,0	61,1	114,3	5	76,0	168,0	12,5	RENAULT	77 01 207 898
24.0110-0333.1	410333	B					280,0	10,0	8,5	59,2	114,3	5	62,0	173,0	14,7	MG	86 71 018 107
24.0110-0334.1	410334	B					258,0	10,0	8,0	41,4	114,3	4	76,0	154,0	13,0	SDB000290	SDB000290
24.0110-0335.1	410335	B					291,0	10,0	8,5	61,3	114,3	5	62,0	190,0	14,5	MERCEDES BENZ	204 423 15 12
24.0110-0336.1	410336	B					284,0	10,0	8,4	54,5	114,3	5	76,0	190,0	12,6	HONDA	42510-SWW-G01
24.0110-0337.1	410337	B					270,0	9,9	8,0	36,8	114,3	5	62,0	166,0	14,8	CITROEN	42510-T1G-G01
24.0110-0338.1	410338	B					262,0	10,0	8,4	61,0	114,3	5	76,0	168,0	12,5	MITSUBISHI	4249 62
24.0110-0339.1	410339	S	B				278,0	10,0	8,0	42,0	110,0	5/7	65,5	149,0	14,0	PEUGEOT	4615A035
24.0110-0340.1	410340	S	B				258,0	10,5	8,0	57,2	114,3	4	60,0	168,0	12,6	SMART	4249 F4
24.0110-0341.1	410341	B					275,0	10,0	8,4	61,0	114,3	5	76,0	168,0	12,5	HYUNDAI	58411-1H100
24.0110-0344.1	410344	B					302,0	10,0	8,4	58,7	114,3	5	69,0	190,0	12,5	KIA	58411-1H300
24.0110-0345.1	410345	B					262,0	10,0	8,4	60,1	114,3	5	80,0	168,0	12,5	TOYOTA	58411-1H100
24.0110-0346.1	410346	B					298,0	10,0	8,5	64,4	114,3	5	62,0	190,0	14,5	TOYOTA	58411-1H300
24.0110-0347.1	410347	B					264,0	10,0	8,0	40,5	110,0	5	70,0	136,8	14,0	TOYOTA	42431-05050
24.0110-0349.1	410349	B					251,0	10,0	9,0	40,5	98,0	4	59,0	128,0	13,2	KIA	58411-2F100
24.0110-0350.1	410350	B					269,0	10,0	9,0	64,7	100,0	5	55,0	170,0	14,5	LEXUS	43431-30280
24.0110-0351.1	410351	S	B	HC	L		300,0	10,0	8,3	58,3	112,0	5	67,0	180,0	15,3	HYUNDAI/KIA	58411-3L000
24.0110-0352.1	410352	B	HC	L			299,0	10,4	8,5	67,6	139,5	6	105,6	190,0	16,0	TOYOTA	58411-3L010
24.0110-0355.1	410355	B					290,0	10,0	8,0	46,0	139,5	5	108,2	183,0	12,8	HYUNDAI	42431-02170
24.0110-0356.1	410356	S	B				272,0	9,7	8,0	48,2	112,0	9	65,0	174,5	15,3	TOYOTA	42431-12280
24.0110-0357.1	410357	B					258,0	10,0	8,0	40,5	114,3	5	76,0	154,0	12,5	HYUNDAI	58411-2H300
24.0110-0358.1	410358	S	B				280,0	10,0	8,4	50,2	120,0	5	79,0	151,8	16,5	OPEL/VAUXHALL	5 69 122/93184247
24.0110-0359.1	410359	S	B				264,0	10,0	8,0	40,5	110,0	5/5	70,0	136,8	14,0/11,0	CHEVROLET	96549630
24.0110-0360.1	410360	B					302,0	10,0	8,4	60,1	114,3	5	80,0	168,0	12,6	DAEWOO	96549630
24.0110-0361.1	410361	B					302,0	10,0	8,4	61,3	114,3	5	80,0	168,0	12,6	KIA	58411-1D000
24.0110-0362.1	410362	B					262,0	10,0	8,4	63,8	114,3	5	76,0	168,0	12,6	MITSUBISHI	MR955407
24.0110-0363.1	410363	B					262,0	10,0	8,4	60,2	114,3	5	80,0	168,0	12,6	MR955407	MN116332
24.0110-0364.1	410364	B					279,0	10,0	8,5	30,6	100,0	5	55,0	155,8	14,5	MITSUBISHI	4615A119
																TOYOTA	42431-28130
																OPEL/VAUXHALL	5 69 418/93190227
																ALFA ROMEO	51805559
																	51813705
																	51865104
																	51865132
																	42431-20320
																	230 423 07 12
																	4840105101
																	4840105110
																	55211-76J00
																	55211-76J01
																	1K0 615 601 AA
																	58411-1P300
																	34 21 9 811 539
																	51806283
																	51815313
																	16 062 920 80
																	4615A121
																	16 062 920 80
																	4743 999AA
																	K04743999AA
																	4743 999AA
																	K04743999AA
																	58411-2K300
																	5105 515AA
																	5105 515AA
																	42431-52160

Abmessungen Bremsscheiben

Dimensions brake discs - Misure dischi freno -

Dimensions Disques de frein - Medidas disco de freno

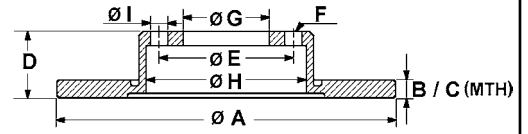

S Fixierschraube - fixing screw - vite di riparazione - vis de fixation - tornillo quefija
 L legiert - alloyed - alligato/legato - allié - aleado
 ● gelocht - perforated - perforato - poinçonné - perforado
 B beschichtet - coated - rivestito - revêtu - recubierto
 V ventiliert - ventilated - ventilato - ventilé - ventilado
 HC hochgekohlt - high carbon - ad alto tenore di carbonio - à haute teneur en carbone - altamente carbonizado

		S	B	H	C	L	V	A	B	C	D	E	F	G	H	I	OE - #	
24.0110-0366.1	410366		B					286,0	10,0	8,5	63,5	100,0	5	58,0	190,0	13,0	SUBARU	26700FG000
24.0110-0367.1	410367		B					284,0	10,0	8,4	54,3	114,3	5	76,0	168,0	12,5	HYUNDAI	58411-3K110
24.0110-0368.1	410368		B					262,0	10,0	8,4	45,9	114,3	5	76,0	162,3	12,5	HYUNDAI	58411-3X300
24.0110-0369.1	410369		B					300,0	10,0	8,4	24,5	114,3	5	76,0	155,0	12,5	HYUNDAI	58411-3Z700
24.0110-0370.1	410370		B					284,0	10,0	8,4	24,7	114,3	5	76,0	154,5	12,5	HYUNDAI	58411-3Z100
24.0110-0378.1	410378		B					251,0	10,0	9,0	40,5	98,0	5	59,0	128,0	13,2	FIAT	51808471 51885409
24.0110-0379.1	410379		B	HC	L			262,0	10,0	8,4	45,1	114,3	5	76,0	162,0	12,5	HYUNDAI	58411-A6300
24.0110-0381.1	410381		B					303,0	10,0	8,0	39,8	114,3	5	68,0	143,0	13,0	KIA	58411-A6300
24.0110-0382.1	410382		S	B				295,0	10,0	8,3	44,0	112,0	5	67,0	161,0	15,2	MAZDA	58411-A6200
24.0110-0383.1	410383		B	HC	L			284,0	10,0	8,4	25,9	114,3	5	76,0	155,2	12,5	MERCEDES BENZ	246 423 01 12 246 423 07 12
24.0110-0388.1	410388		B	HC	L			284,0	10,0	8,4	55,3	114,3	5	76,0	168,0	12,5	HYUNDAI/KIA	58411-A6200
24.0110-0389.2	410389		B					270,0	10,0	9,0	80,7	108,0	5	52,0	55,0	M12x1,5	HYUNDAI/KIA	58411-3S100
24.0110-0391.1	410391		S	B	HC	L		300,0	10,0	8,3	43,0	112,0	5	67,0	161,0	15,2	RENAULT	77 01 208 850
24.0110-0392.1	410392		B					284,0	10,0	8,4	45,0	114,3	5	76,0	184,2	12,5	MERCEDES BENZ	000 423 16 12 172 423 02 12
24.0110-0394.1	410394		B					234,0	10,0	8,4	44,9	100,0	4	62,4	142,0	13,0	KIA	58411-A4000
24.0110-0700.1	410700							269,0	10,0	9,0	64,8	114,3	5	62,0	170,0	14,5	HYUNDAI	58411-B4300 58411-B9000
24.0110-0704.1	410704		B					262,0	10,0	8,4	60,1	114,3	5	90,0	168,0	12,5	TOYOTA	42431-33010
24.0110-0712.1	410712		B					288,0	10,0	8,5	60,0	114,3	5	62,0	170,0	14,5	MITSUBISHI	MB895200 MB928716
24.0110-0714.1	410714							258,0	10,3	8,0	64,7	100,0	4	57,0	168,0	13,0	LEXUS	42431-33080 42431-33140
24.0110-0728.1	410728		B					273,8	10,0	8,5	67,5	100,0	5	58,0	170,0	13,0	CHEVROLET	96312560
24.0111-0100.2	411100		B					300,0	11,0	9,5	84,7	108,0	5	62,0	52,3	M14x1,5	DAEWOO	96312560
24.0111-0101.2	411101		B					274,0	10,9	9,5	82,2	108,0	5	62,0	52,3	M12x1,5	SUBARU	26700AG001
24.0111-0115.1	411115		B					252,5	10,0	9,0	65,0	98,0	4	68,0	118,0	13,0	RENAULT	82 00 649 353 82 00 655 249 86 71 018 108 86 60 001 813
24.0111-0116.1	411116							238,0	11,0	8,0	55,5	92,0	4	73,0	112,5	10,5	LADA	2101-3103002 2101-3501070
24.0111-0119.1	411119		B					240,5	11,0	9,2	40,0	98,0	4	59,0	123,0	13,0	OPEL/VAUXHALL	5 69 041/90272326
24.0111-0120.1	411120							269,5	10,5	9,5	65,9	114,3	4	86,0	145,0	13,6	ALFA/FIAT/LANCIA	7663465 7685656 46403960 51876438 60811879 71769481 71772238
24.0111-0122.1	411122							255,0	10,5	9,5	30,6	100,0	4	66,0	134,0	12,6	FIAT	51859078 71738421 1715410
24.0111-0125.1	411125		B					230,0	11,0	8,4	43,8	114,3	4	67,4	142,0	12,6	FORD	BS51-1125-AA
24.0111-0129.1	411129							251,0	11,0	9,5	51,0	98,0	4	62,0	135,0	13,0	SAAB	8904575
24.0111-0130.1	411130		B					227,0	10,8	9,0	45,8	98,0	4	62,0	117,0	13,0	RENAULT	77 00 764 192 77 01 204 288
24.0111-0133.1	411133		B					278,0	11,0	9,0	50,2	117,8	5	70,7	175,3	16,2	HYUNDAI	51712-02110
24.0111-0137.1	411137		S	B				262,0	11,0	9,0	45,5	112,0	5	67,0	142,5	15,0	FIAT	4377102
24.0111-0139.1	411139							234,0	11,0	10,0	47,0	100,0	4	56,0	128,5	13,4	SEAT	SE022165002B
24.0111-0141.1	411141							256,0	10,8	8,0	41,1	100,0	6	60,0	123,0	14,3	AUTOB/FIAT/LANCIA	4385812 16500253 SE022165002A
24.0111-0142.1	411142		B					240,5	11,0	9,2	40,0	98,0	5	59,0	123,0	13,0	OPEL/VAUXHALL	5 69 110/9195294
24.0111-0144.1	411144		B					265,0	10,5	9,5	44,3	108,0	5	61,0	149,5	15,5	MERCEDES BENZ	201 421 12 12
24.0111-0145.1	411145		B					302,0	10,9	9,0	50,8	108,0	5	63,5	177,6	15,8	DAIHATSU	43512-87709-000 43512-87717-000 43512-87727-000
24.0111-0146.1	411146		B					302,0	11,0	9,4	71,5	114,3	5	69,0	190,0	12,5	OPEL/VAUXHALL	5 69 058/9117676
24.0111-0147.1	411147		B					302,0	11,0	9,0	40,8	108,0	5	63,5	177,6	16,0	ALFA ROMEO	60670804 71739571
24.0111-0148.2	411148		B					274,0	10,9	9,5	82,2	100,0	4	62,0	52,3	M12x1,5	RENAULT	77 01 205 846 86 71 019 317
24.0111-0149.1	411149							240,5	11,0	9,2	40,0	98,0	4	59,0	124,5	13,0	FORD	1379931 1385590 1405500 LR027123
																	HYUNDAI	58411-2B000
																	VOLVO	30769059
																	RENAULT	77 01 208 230
																	ALFA ROMEO	60576335 60805117



Abmessungen Bremsscheiben

Dimensions brake discs - Misure dischi freno -

Dimensions Disques de frein - Medidas disco de freno

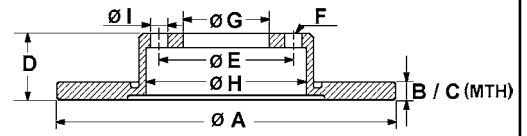

S Fixierschraube - fixing screw - vite di riparazione - vis de fixation - tornillo quefija

B beschichtet - coated - rivestito - revêtu - recubierto

HC hochgekohlt - high carbon - ad alto tenore di carbonio - à haute teneur en carbone - altamente carbonizado

L legiert - alloyed - alligato/legato - allié - aleado

V ventiliert - ventilated - ventilato - ventilé - ventilado

● gelocht - perforated - perforato - poinçonné - perforado

		S	B	HC	L	V	A	B	C	D	E	F	G	H	I	OE	#
24.0111-0150.1	411150						257,0	10,5	9,5	35,3	100,0	4	61,0	134,0	12,6	RENAULT	77 01 204 291
24.0111-0151.1	411151		B				265,0	10,5	9,5	54,3	108,0	5	66,0	149,6	15,5	RENAULT	60 25 304 079 60 25 370 406 86 71 012 048
24.0111-0152.1	411152		B				240,0	11,0	8,0	41,0	100,0	4/6	60,0	126,0	14,5	OPEL/VAUXHALL	5 69 020/9195981
24.0111-0153.1	411153		B				300,0	11,0	9,3	58,5	112,0	5	67,0	180,0	15,0	MERCEDES BENZ	220 423 01 12
24.0111-0154.1	411154		B				278,0	11,0	9,0	53,7	108,0	5	63,5	146,0	13,7	FORD	1362867 1362868 4367107 4457989 4475316 2T14-2A315-AC 2T14-2A315-BC
24.0111-0155.1	411155		B				265,0	11,0	9,0	40,8	108,0	5	63,5	152,0	13,7	FORD	1223540 1253728 1373360 1575733 1748745 9M51-2A315-BA 9M51-2A315-BB
24.0111-0158.1	411158		B				280,0	11,0	9,0	41,0	108,0	5	63,5	192,0	13,7	FORD	1253962 1373361 1500156 7M51-2A315-BA 30769113 31341645
24.0111-0159.1	411159		B				211,0	11,0	10,0	40,9	100,0	4	55,1	125,0	13,2	DAIHATSU	43512-97204-000 43512-97207-000 43512-B2100-000
24.0111-0160.1	411160		B				280,0	11,0	9,0	40,8	114,3	5	72,0	154,0	14,0	MAZDA	BP6Y-26-251D C25Y-26-251A C25Y-26-251B
24.0111-0164.1	411164		B				265,0	11,0	9,0	40,7	114,3	5	72,0	152,0	14,0	MAZDA	BP4Y-26-251C C24Y-26-251C
24.0111-0165.1	411165		B				302,0	11,0	9,0	40,8	114,3	5	72,0	153,0	13,7	MAZDA	C26Y-26-251A
24.0111-0166.2	411166		B				274,0	10,9	9,5	82,2	100,0	4	62,0	52,3	M12x1,5	RENAULT	86 60 001 815
24.0111-0167.2	411167		B				300,0	11,0	9,5	84,7	108,0	5	62,0	52,3	M12x1,5	RENAULT	82 00 663 193 86 71 018 264 86 71 019 319
24.0111-0168.1	411168		B				297,0	11,0	9,0	58,5	114,3	5	62,0	180,0	14,5	TOYOTA	42431-0F020
24.0111-0169.1	411169		B				290,0	11,0	9,0	33,7	114,3	5	62,0	155,0	14,5	TOYOTA	42431-05070
24.0111-0170.1	411170		B	HC L			302,0	11,0	9,4	71,5	114,3	5	69,0	190,0	12,5	HYUNDAI KIA	58411-2P000 58411-2P000
24.0111-0171.1	411171		B				271,0	11,0	9,0	40,7	108,0	5	63,5	152,0	13,8	FORD	1704765
24.0111-0172.1	411172		B				280,0	11,0	9,0	50,7	108,0	5	63,5	153,5	13,7	FORD	1683383 AV61-2A315-BA 1683384 AV61-2A315-AA
24.0111-0173.2	411173		B				300,0	11,0	9,5	81,7	114,3	5	52,0	62,0	M14x1,5	RENAULT	40 20 200 03R 40 20 222 91R 43 20 000 15R
24.0111-0174.2	411174		B				274,0	11,0	9,5	88,2	108,0	5	52,0	62,0	M12x1,5	RENAULT	82 00 381 148
24.0111-0175.1	411175		S	B	HC		290,0	11,0	9,4	66,0	120,0	5	75,0	160,8	16,5	BMW	34 21 6 792 225
24.0111-0180.2	411180		B				274,0	11,0	9,5	86,2	114,3	5	52,3	62,0	M12x1,5	RENAULT	40 20 296 46R
24.0111-0181.2	411181		B				300,0	11,0	9,5	101,7	114,3	5	52,0	62,0	M14x1,5	RENAULT	40 20 200 05R
24.0111-0182.2	411182		B				274,0	11,0	9,5	88,2	108,0	5	52,0	62,0	M12x1,5	MERCEDES BENZ RENAULT	415 420 01 02 40 20 240 76R 43 20 043 27R
24.0111-0183.2	411183		B				300,0	11,0	9,5	102,2	108,0	5	52,3	62,0	M14x1,5	RENAULT	82 00 736 267
24.0111-0184.2	411184		B				290,0	11,0	9,5	90,2	114,3	5	52,3	62,0	M12x1,5	RENAULT	43 20 200 16R 40 20 205 36R
24.0112-0102.1	412102						231,0	12,0	10,0	44,0	100,0	4	61,0	124,0	12,6	HONDA ROVER	45251-SB2-030 45251-SB2-732 DBP3169 GBD90810 GBD90818 GBD90827
24.0112-0106.1	412106		S	B			239,0	12,0	10,0	35,4	100,0	4	65,0	124,5	13,6	AUDI/SEAT/VW AUDI/VW	321 615 301 175 615 301
24.0112-0111.1	412111						284,0	12,0	10,4	76,0	120,0	5	79,0	146,0	14,5	BMW	34 11 1 163 134
24.0112-0112.1	412112						257,0	12,0	10,8	51,5	98,0	4	62,0	135,0	13,0	FIAT/LANCIA	4448411
24.0112-0115.1	412115						239,8	12,0	11,0	35,0	96,0	4	76,0	128,8	8,3	NISSAN	40206-05A01

Abmessungen Bremsscheiben

Dimensions brake discs - Misure dischi freno -

Dimensions Disques de frein - Medidas disco de freno

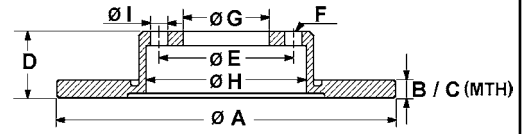

S Fixierschraube - fixing screw - vite di riparazione - vis de fixation - tornillo quefija
 B beschichtet - coated - rivestito - revêtu - recubierto
 HC hochgekohlt - high carbon - ad alto tenore di carbonio - à haute teneur en carbone - altamente carbonizado
 L legiert - alloyed - alligato/legato - allié - aleado
 V ventiliert - ventilated - ventilato - ventilé - ventilado
 ● gelocht - perforated - perforato - poinçonné - perforado

		S	B	H	C	L	V	A	B	C	D	E	F	G	H	I	OE - #
24.0112-0116.1	412116	S	B					238,0	12,0	10,5	41,0	100,0	4	61,0	129,5	13,5	DACIA RENAULT 60 01 549 211 60 01 549 211 77 01 204 282 86 71 000 083
24.0112-0117.1	412117	S	B					284,0	12,0	10,0	46,5	112,0	5	67,0	154,3	15,0	MERCEDES BENZ 124 421 13 12
24.0112-0120.1	412120			HC				300,0	12,0	10,4	67,9	120,0	5	75,0	180,0	14,5	BMW 34 21 1 165 257
24.0112-0121.1	412121							214,0	12,0	10,0	43,2	100,0	4	59,0	125,5	12,5	NISSAN 40206-01B00 40206-01B01
24.0112-0122.1	412122							240,0	12,0	10,8	46,5	98,0	4	59,0	127,5	13,0	AUTOB/FIAT/LANCIA 71738423
24.0112-0123.1	412123							240,3	12,0	11,0	45,1	100,0	4	61,0	126,5	12,6	NISSAN 40206-61A01 40206-61A11
24.0112-0124.1	412124	S	B	HC				302,0	12,0	10,4	76,0	120,0	5	79,0	149,0	14,5	BMW 34 11 1 161 693
24.0112-0125.1	412125		B					239,0	12,0	10,8	42,5	98,0	4	58,5	127,0	13,1	LADA 2108-3501070
24.0112-0126.1	412126	S	B					286,0	12,0	10,4	51,5	120,0	5	79,0	148,0	14,5	BMW 34 11 6 757 750 34 11 6 757 751
24.0112-0127.1	412127		B					257,5	12,0	10,2	40,5	98,0	4	59,0	123,0	13,0	ALFA/FIAT/LANCIA 7663466 46820655 51859075 51866265 60808872 51866264
24.0112-0128.1	412128	S	B					284,0	12,0	10,0	43,5	112,0	5	67,0	154,3	12,8	FIAT MERCEDES BENZ 202 421 02 12
24.0112-0129.1	412129			HC				290,0	12,0	9,8	60,0	112,0	5	67,0	164,0	17,0	MERCEDES BENZ 140 423 06 12
24.0112-0130.1	412130							272,0	11,0	9,9	50,5	140,0	5	108,0	157,0	14,5	LADA 2121-3501070
24.0112-0131.1	412131		B					286,0	12,0	10,0	69,5	110,0	5	65,5	160,0	14,0	OPEL/VAUXHALL 5 69 208/90444513
24.0112-0132.1	412132	S	B	HC				324,0	12,0	10,4	61,0	120,0	5	75,0	180,0	14,5	BMW 34 21 6 757 748
24.0112-0133.1	412133							253,8	12,0	10,5	54,2	108,0	5	66,0	134,0	14,7	RENAULT 77 01 467 307
24.0112-0134.1	412134							253,8	12,0	10,5	54,2	100,0	4	66,0	134,0	12,6	RENAULT 77 01 467 306
24.0112-0135.1	412135							260,0	12,0	10,8	40,0	100,0	4/6	61,0	127,0	13,0	VOLVO 3459661
24.0112-0136.2	412136							251,0	12,0	10,8	62,3	108,0	5	71,0	134,7	13,0	CITROEN 95 661 796
24.0112-0137.1	412137		B					234,0	12,0	10,0	45,2	100,0	4	59,0	129,5	12,5	NISSAN 40206-5F003
24.0112-0138.1	412138	S	B					280,0	12,0	10,0	40,4	112,0	5	68,2	153,0	16,5	VOLKSWAGEN 701 615 601 A 7D0 615 601 7D0 615 601 B
24.0112-0139.1	412139							214,0	12,0	10,0	46,2	100,0	4	61,0	126,6	12,6	NISSAN 40206-21B01
24.0112-0141.1	412141		B					239,5	12,0	10,0	42,9	108,0	4	63,5	136,0	13,7	FORD 1013581 1019598 1112542 MAZDA 1E03-33-251 1E03-33-251A 1E04-33-251
24.0112-0142.1	412142	S	B	HC	L			258,0	12,0	10,0	96,7	130,0	5	85,0	160,0	15,0	MERCEDES BENZ 901 423 06 12 901 423 08 12 901 423 10 12 VOLKSWAGEN 2D0 615 601 2D0 615 601 C
24.0112-0143.1	412143							251,0	12,0	10,8	62,4	108,0	4	71,1	135,0	13,0	CITROEN 4246 L6
24.0112-0144.1	412144	S	B	HC	L			260,0	12,0	10,0	40,4	112,0	5	67,0	145,0	13,3	MERCEDES BENZ 168 421 01 12
24.0112-0145.1	412145							265,6	12,0	10,6	48,0	139,7	6	96,5	171,6	12,6	ISUZU 8-94173-244-0 8-94173-244-2
24.0112-0147.1	412147							234,5	12,0	10,0	45,0	100,0	4	55,0	124,5	13,0	MAZDA DB0Y-33-251
24.0112-0148.1	412148		B					255,0	12,0	10,0	40,0	112,0	5/9	68,0	144,5	15,3	AUDI 8E0 615 601 D 8E0 615 601 Q
24.0112-0149.1	412149		B					290,0	12,0	10,3	56,0	112,0	5	67,0	164,0	13,0	MERCEDES BENZ 210 423 05 12
24.0112-0150.1	412150		B					277,0	11,9	10,0	71,0	108,0	5	68,0	160,0	16,5	VOLVO 272301
24.0112-0151.1	412151		B					288,0	11,9	10,0	64,8	108,0	5	68,0	178,0	16,5	VOLVO 9434167
24.0112-0152.1	412152		B	HC				324,0	12,0	10,4	80,2	120,0	5	75,0	185,0	16,8	BMW 34 21 6 859 678
24.0112-0153.1	412153		B					247,0	12,0	10,5	44,0	100,0	4	60,0	125,0	12,8	OPEL/VAUXHALL 47 00 711/9193872 SUZUKI 55311-83E00
24.0112-0154.1	412154		B					280,0	12,0	10,0	34,0	108,0	5	63,5	151,0	13,7	FORD 1676983 4176921 4179406 7S7J-2A315-BB JAGUAR C2S 49730 C2S 52088
24.0112-0155.1	412155	S	B					305,0	12,0	10,5	66,8	130,0	5	90,0	169,5	15,5	NISSAN 43206-00QAA OPEL/VAUXHALL 44 03 045/9111045
24.0112-0156.1	412156		B					272,0	12,0	10,0	28,0	98,0	5	59,0	134,0	15,0	RENAULT 77 00 314 107 CITROEN 4249 C0 FIAT/LANCIA 9464222687 9464222688 PEUGEOT 4249 C0



Abmessungen Bremsscheiben

Dimensions brake discs - Misure dischi freno -

Dimensions Disques de frein - Medidas disco de freno

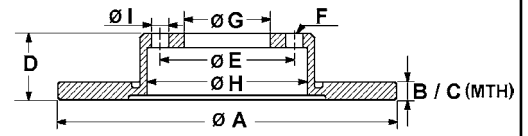

S Fixierschraube - fixing screw - vite di riparazione - vis de fixation - tornillo quefija

B beschichtet - coated - rivestito - revêtu - recubierto

HC hochgekohlt - high carbon - ad alto tenore di carbonio - à haute teneur en carbone - altamente carbonizado

L legiert - alloyed - alligato/legato - allié - aleado

V ventiliert - ventilated - ventilato - ventilé - ventilado

● gelocht - perforated - perforato - poinçonné - perforado

		S	B	HC	L	V	A	B	C	D	E	F	G	H	I	OE	#
24.0112-0157.1	412157	S	B				278,0	11,9	10,0	41,4	110,0	5	65,5	145,2	14,0	FIAT	46836489 71772552
																OPEL/VAUXHALL	5 69 115/93171848
																SAAB	9156785 12762290
24.0112-0158.1	412158		B				256,0	12,0	10,0	48,6	112,0	5/9	65,0	140,0	15,3	AUDI/SKODA/VW	1K0 615 601 AC 1K0 615 601 L
24.0112-0159.1	412159		B				302,0	12,0	10,0	49,4	112,0	5/9	68,0	177,0	15,3	AUDI	4F0 615 601 E
24.0112-0160.1	412160		B				280,5	12,0	11,0	45,1	100,0	4	61,0	149,0	13,5	RENAULT	77 01 207 227 86 71 019 318
24.0112-0162.1	412162	S	B				290,0	12,0	10,0	35,0	108,0	5	71,1	151,2	13,0	CITROEN	4249 72 4249 C1
																PEUGEOT	4246 P9 4249 C1
24.0112-0164.1	412164		B				291,0	12,0	10,5	68,4	114,3	5	62,0	190,0	14,5	TOYOTA	42431-28091 42431-28120
24.0112-0165.1	412165		B				288,0	12,0	10,0	62,0	108,0	5	68,0	178,0	16,0	VOLVO	272429
24.0112-0166.1	412166		B				288,0	12,0	10,0	36,0	112,0	5	68,0	162,0	15,3	AUDI	8E0 615 601 M
24.0112-0167.1	412167	S	B	HC	L		276,0	12,0	10,0	44,5	112,0	5	67,0	145,0	15,3	MERCEDES BENZ	169 421 00 12
24.0112-0168.1	412168		B				354,0	11,9	10,4	74,9	120,0	5	79,0	210,0	16,6	LAND ROVER	SDB000211
24.0112-0169.1	412169	S	B				282,0	12,0	10,0	48,6	112,0	5/9	65,0	159,0	15,3	AUDI/SKODA/VW	1K0 615 601 AD 1K0 615 601 M
24.0112-0170.1	412170	S	B				278,0	12,0	10,0	43,2	110,0	5	70,0	139,0	16,6	ALFA ROMEO	51760273 51767378
																FIAT	51964082
																JEEP	51963547
24.0112-0171.1	412171	S	B				259,0	12,0	10,6	40,9	100,0	4	61,0	130,0	13,5	DACIA	60 01 547 683 77 01 208 252
																RENAULT	60 01 547 683 77 01 208 252
24.0112-0172.1	412172	S					282,0	12,0	10,0	58,5	114,3	5	64,2	170,0	12,8	SMART	453 420 00 00
24.0112-0173.1	412173		B				232,0	12,0	9,5	51,0	114,3	4	64,0	137,0	12,7	HONDA	42510-S7A-J50
																SUZUKI	55311-60B21 55311-60B22
24.0112-0174.1	412174		B				290,0	12,0	10,0	50,0	108,0	5	71,1	144,0	13,0	PEUGEOT	4249 14
24.0112-0175.1	412175	S	B				286,0	12,0	10,0	58,6	112,0	5	65,0	140,0	15,3	AUDI	8J0 615 601
24.0112-0176.1	412176		B	HC	L		302,0	12,0	10,0	42,4	112,0	5/9	68,0	176,5	15,3	AUDI	4F0 615 601 G
24.0112-0177.2	412177		B				280,0	12,0	10,0	102,2	118,0	5	68,0	64,5	M14x1,5	NISSAN	43206-00QAB 43206-00QAC 43206-00QAD
																OPEL/VAUXHALL	44 13 736/93161254
																RENAULT	77 11 130 076 86 71 019 313
24.0112-0178.1	412178	S	B				300,0	12,0	10,0	36,4	112,0	5	68,0	169,0	15,3	AUDI	8K0 615 601 B
24.0112-0180.1	412180		B				302,0	12,0	10,0	69,2	108,0	5	63,5	178,0	15,8	VOLVO	30769058
24.0112-0181.1	412181		B				302,0	12,0	11,0	56,1	114,3	5	72,0	185,0	14,2	FORD	4659167
																MAZDA	EF91-26-251
24.0112-0183.1	412183	S	B				300,0	12,0	10,0	58,3	112,0	5	67,0	180,0	15,3	MERCEDES BENZ	221 423 11 12
24.0112-0184.1	412184	S	B				257,0	12,0	10,0	40,5	100,0	4/6	60,0	127,0	14,3	FIAT	51806099 51806103 55700398 55700918
																OPEL/VAUXHALL	5 69 022/93188916
24.0112-0185.1	412185						324,0	11,9	10,4	69,5	139,6	6	96,3	210,0	12,5	KIA	58411-4D000
24.0112-0186.1	412186		B				302,0	12,0	10,0	66,0	108,0	5	63,6	185,0	15,7	LAND ROVER	LR001018
24.0112-0187.1	412187	S	B				292,0	12,0	10,5	48,0	120,0	5	67,4	171,5	16,3	OPEL/VAUXHALL	5 69 025/13501302 5 69 127/13502198 13502198
24.0112-0188.1	412188	S	B				268,0	12,0	10,0	44,9	105,0	5	60,0	147,0	14,2	SAAB	13502135/13502136
																CHEVROLET	5 69 074/13502134
24.0112-0189.1	412189	S	B				292,0	12,0	10,0	45,0	115,0	5	70,7	157,0	14,2	OPEL/VAUXHALL	13502139
																CHEVROLET	5 69 071/13502138 5 69 075/13502137 5 69 085/13504280
																OPEL/VAUXHALL	44 21 080/93168847
24.0112-0190.1	412190	S	B	HC	L		305,0	12,0	10,0	71,5	130,0	5	91,0	167,5	17,0	NISSAN	43206-00Q0B
																RENAULT	43 20 640 87R
24.0112-0191.1	412191	S	B	HC	L		305,0	12,0	10,0	71,4	130,0	5	90,0	167,0	15,5	NISSAN	43206-00Q0A
																OPEL/VAUXHALL	44 19 362/93197406
																RENAULT	43 20 003 67R
24.0112-0193.1	412193		B				316,0	12,0	10,4	68,6	127,0	5	72,0	206,0	16,6	JEEP	5206 0147AA
24.0112-0194.2	412194		B				268,0	12,0	10,0	73,2	108,0	4	56,0	62,0	M12x1,25	CITROEN/PEUGEOT	4249 46
24.0112-0195.1	412195		B				278,0	12,0	11,0	46,0	114,3	5	62,0	169,2	12,8	SUZUKI	55611-57L00
24.0112-0197.1	412197	S	B				290,0	12,0	10,0	44,0	108,0	5	71,1	136,0	13,0	PEUGEOT	4249 G2



Abmessungen Bremsscheiben

Dimensions brake discs - Misure dischi freno -

Dimensions Disques de frein - Medidas disco de freno

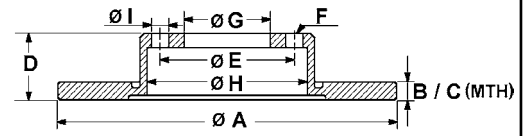

S Fixierschraube - fixing screw - vite di riparazione - vis de fixation - tornillo quefija
 B beschichtet - coated - rivestito - revêtu - recubierto
 HC hochgekohlt - high carbon - ad alto tenore di carbonio - à haute teneur en carbone - altamente carbonizado
 L legiert - alloyed - alligato/legato - allié - aleado
 V ventiliert - ventilated - ventilato - ventilé - ventilado
 ● gelocht - perforated - perforato - poinçonné - perforado

		S	B	HC	L	V	A	B	C	D	E	F	G	H	I	OE	#
24.0113-0193.1	413193						236,0	12,8	11,4	48,9	100,0	4	62,0	124,7	13,0	SKODA	115 430 212
24.0113-0194.1	413194	B					294,0	13,5	11,5	41,0	112,0	5	68,2	165,0	16,5	FORD	1140278
24.0113-0195.1	413195	B					236,0	12,6	9,7	35,4	102,0	4	86,0	107,5	M10x1,25	SEAT/VW CHEVROLET	7D0 615 601 C 96284392 96455424 96284392
24.0113-0196.1	413196	B					290,0	12,5	11,3	56,0	114,3	5	72,0	180,0	14,5	DAEWOO CHRYSLER	4721 023 4721 023AF 4721 023AG
24.0113-0197.1	413197	B					304,5	12,6	11,7	62,8	120,0	5	70,0	161,5	14,3	LAND ROVER	NTC8781 SDB000210 SDB000470
24.0113-0198.1	413198	B					262,0	13,0	11,0	44,5	100,0	4	64,2	141,0	13,0	ROVER	GBD90841 SDB100500
24.0114-0100.1	414100						270,0	14,3	12,9	71,2	100,0	5	78,5	120,0	M10	FORD	5022674 5022677
24.0114-0101.1	414101						263,0	14,3	12,7	65,0	108,0	5	68,1	139,0	16,3	VOLVO	270737
24.0114-0102.1	414102						257,5	14,0	12,8	50,7	98,0	4	59,0	128,7	13,2	FIAT/LANCIA	82434169
24.0114-0103.1	414103						254,0	14,3	12,9	31,5	100,0	5	78,5	138,0	M10	FORD	5022676
24.0114-0107.1	414107						280,0	14,0	12,6	55,5	138,0	5	112,0	150,0	M10x1,5	PEUGEOT	4246 69 4246 B8
24.0114-0108.1	414108	B					298,5	14,0	13,0	70,0	127,0	5	101,6	160,5	10,0	LAND ROVER	FRC7329 FRC7392 FTC3846
24.0114-0110.2	414110						267,0	14,2	12,8	111,0	170,0	6	58,3	115,0	M18x1,5	IVECO	93800492
24.0114-0111.1	414111	B					331,0	13,9	12,3	55,3	112,0	5	67,0	184,0	15,3	MERCEDES BENZ	163 423 00 12
24.0114-0112.1	414112	S B					276,0	14,0	12,0	62,0	108,0	4	71,0	136,5	13,0	CITROEN	4246 W4
24.0114-0113.1	414113	B					262,0	14,0	11,0	51,0	114,3	5	66,1	140,8	12,6	LAND ROVER	SDB100830
24.0114-0114.1	414114	S B	HC	L			330,0	14,0	11,4	63,0	112,0	5	67,0	210,0	15,2	MERCEDES BENZ	164 423 05 12 164 423 12 12
24.0114-0115.1	414115						298,0	14,0	13,0	59,0	127,0	5	101,6	159,6	10,2	LAND ROVER	SDB000330 SDB100980
24.0114-0116.1	414116	S B					290,0	14,0	12,0	49,0	108,0	5	71,0	143,7	13,2	CITROEN	4249 23 4249 91 16 118 410 80 9467548487 9404249918 4249 22 4249 91 SU001-A1062
24.0114-0118.1	414118	B					320,0	14,0	12,5	66,3	127,0	5	72,0	205,0	16,2	TOYOTA	5208 9275AB
24.0114-0119.1	414119	S B	HC	L			325,0	14,0	11,4	54,0	112,0	5	67,0	183,0	15,0	JEEP	166 423 00 12
24.0115-0105.1	415105	B	HC				288,0	15,0	13,0	46,5	112,0	5	68,0	135,5	15,4	MERCEDES BENZ	4A0 615 301 B
24.0115-0106.1	415106				V		214,0	15,0	13,0	46,2	100,0	4	61,0	126,5	12,6	AUDI	40206-27B01
24.0115-0108.1	415108	B					281,0	15,0	13,2	44,7	98,0	5	59,0	127,0	13,0	NISSAN	60658567
24.0115-0109.1	415109	B	HC		V		239,0	15,0	13,0	34,5	100,0	4/6	65,0	124,7	13,6	ALFA ROMEO	6E0 615 301
24.0115-0111.1	415111	B					285,0	15,0	13,0	52,5	112,0	5	67,0	184,0	15,0	AUDI/VW	163 421 01 12
24.0115-0112.1	415112						281,0	15,0	13,2	44,7	98,0	4	59,0	127,0	13,0	MERCEDES BENZ	46763837
24.0116-0100.1	416100	B					280,0	16,0	13,0	78,6	112,0	5	88,0	133,5	12,5	LANCIA	601 420 02 72 601 421 04 12
24.0116-0104.1	416104	B					258,0	16,0	13,0	95,5	112,0	5	45,2	67,9	M14x1,5	MERCEDES BENZ	251 407 617 M
24.0116-0105.1	416105	B					256,0	16,1	13,5	64,1	118,0	5	73,0	141,0	15,5	VOLKSWAGEN	7531819 60809894 93500520
24.0116-0106.1	416106						290,0	16,0	14,8	61,0	118,0	5	73,0	141,0	15,5	CITROEN PEUGEOT	4246 N5 4246 B4 4249 L1 ZF 93 500 521 93500521 4246 H3
24.0116-0107.2	416107						238,5	16,0	14,5	79,0	140,0	5	102,0	138,0	M14x1,5	MERCEDES BENZ	631 420 03 72
24.0116-0108.1	416108						260,0	16,0	13,0	64,0	112,0	5	68,2	144,0	16,5	VOLKSWAGEN	701 615 301 C
24.0116-0109.1	416109						258,0	16,0	13,0	57,5	112,0	5	67,0	135,0	15,5	VOLKSWAGEN	251 407 615 Q
24.0116-0110.1	416110	S B	HC	L			272,0	16,0	14,0	96,7	130,0	5	85,0	160,0	15,0	MERCEDES BENZ	902 423 03 12 902 423 05 12 2D0 615 601 A 2D0 615 601 D
24.0116-0116.2	416116	B					280,0	16,0	13,0	68,7	160,0	5	96,0	120,0	M10x1,5	FORD	1451161
24.0116-0117.1	416117	B					273,0	16,0	15,0	37,5	114,3	5	66,5	162,0	14,0	DAIHATSU	43512-87402-000
24.0116-0118.1	416118				V		234,0	16,0	14,0	37,0	88,0	4	70,0	111,0	M10	DAIHATSU	43512-87220-000



Abmessungen Bremsscheiben

Dimensions brake discs - Misure dischi freno -

Dimensions Disques de frein - Medidas disco de freno

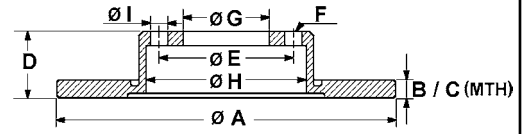

S Fixierschraube - fixing screw - vite di riparazione - vis de fixation - tornillo quefija

B beschichtet - coated - rivestito - revêtu - recubierto

HC hochgekohlt - high carbon - ad alto tenore di carbonio - à haute teneur en carbone - altamente carbonizado

L legiert - alloyed - alligato/legato - allié - aleado

V ventiliert - ventilated - ventilato - ventilé - ventilado

● gelocht - perforated - perforato - poinçonné - perforado

		S	B	HC	L	V	A	B	C	D	E	F	G	H	I	OE - #
24.0116-0119.1	416119		B			V	292,0	16,0	14,0	62,0	114,3	5	68,0	172,0	12,7	NISSAN 43206-8H305 43206-8H700 43206-8H701 43206-8H702 43 20 031 12R
24.0116-0120.1	416120		B			V	234,0	16,0	15,0	40,9	100,0	4	55,1	125,0	13,2	RENAULT DAIHATSU 43512-97202-000
24.0116-0121.1	416121		B				298,0	16,0	14,0	71,0	130,0	6	85,0	180,0	15,0	MERCEDES BENZ VOLKSWAGEN 906 423 00 12 2E0 615 601 A
24.0116-0122.1	416122		B			V	308,0	16,0	14,0	62,0	114,3	5	68,0	190,0	12,8	NISSAN 43206-CA000
24.0116-0123.1	416123		B				300,0	16,0	14,2	80,0	130,0	5	79,0	172,0	17,5	CITROEN 4249 42 4249 K6 FIAT 51740250 51749555 PEUGEOT 4249 41 4249 K6 16 078 806 80
24.0116-0124.1	416124		B				280,0	16,0	14,2	82,0	118,0	5	72,0	172,0	15,6	CITROEN 4246 Y7 4249 K7 4249 L0 FIAT 46833806 51740245 51749274 51848617 PEUGEOT 4246 Y9 4249 K7 4249 L0 16 078 804 80
24.0116-0125.1	416125		B				280,0	16,0	14,2	82,0	130,0	5	79,0	172,0	17,5	CITROEN 4246 Z1 4249 K8 4249 K9 FIAT 46833807 51740248 51749275 51856412 PEUGEOT 4246 Z3 4249 K8 4249 K9 16 078 805 80
24.0116-0126.1	416126		B				280,0	16,0	13,0	16,3	124,0	5/10	107,5	144,5	10,7	FORD 1464031
24.0116-0127.1	416127					V	211,0	16,0	14,0	41,0	88,0	4	70,0	97,0	M10x1,25	DAIHATSU 43512-87215-000
24.0116-0128.1	416128						276,0	16,0	13,0	69,5	118,0	5	73,0	145,0	15,5	IVECO 42471034
24.0116-0129.1	416129						276,0	16,0	13,0	69,5	118,0	5	73,0	145,0	15,5	IVECO 2991646
24.0116-0130.1	416130		B			V	234,0	16,0	15,0	41,0	100,0	4	55,0	125,0	14,0	DAIHATSU SUBARU 43512-B1050-000 43512B1050
24.0116-0132.1	416132		B				280,0	16,0	13,0	62,1	127,0	6	108,0	164,5	10,8	NISSAN 43206-MB600
24.0116-0133.1	416133		S	B			303,0	16,0	13,0	83,0	130,0	5	85,0	158,5	15,0	MERCEDES BENZ 461 421 00 12 461 421 00 12
24.0116-0134.1	416134		B				284,0	16,0	13,0	43,9	124,0	10	107,1	148,0	10,7	FORD 1488311 8C1V-2A315-AA
24.0117-0101.1	417101					V	231,0	17,0	15,0	44,0	100,0	4	61,0	124,0	12,6	HONDA 45251-SB2-932 45251-SB2-940 ROVER DBP7954 GBD90803 GBD90814 GBD90825
24.0117-0103.1	417103		B			V	231,2	17,0	15,0	50,0	114,3	4	64,0	137,5	12,8	SUBARU SUZUKI 5531180F03 55311-60B20 55311-72F00 55311M72F00
24.0117-0104.1	417104					V	287,0	17,0	15,0	46,1	140,0	5	107,0	183,0	13,0	SUZUKI 55211-56B00
24.0117-0105.1	417105		B			V	231,0	17,0	15,0	49,2	100,0	4	60,0	125,0	12,8	SUZUKI 55311-75F00 55311-M75F00
24.0117-0106.1	417106		B			V	253,0	17,0	15,0	49,0	100,0	4	60,0	153,0	12,5	OPEL/AUXHALL 47 06 749/93176389 47 07 288/93179462 SUBARU SUZUKI 5531186G02 55311-84E01 55311-86G02
24.0117-0107.1	417107		B			V	246,0	17,0	16,0	41,9	100,0	4	55,1	137,0	13,2	DAIHATSU 43512-97402-000
24.0117-0108.1	417108		B			V	257,0	17,0	15,0	49,2	100,0	4	60,0	151,0	12,7	SUZUKI 55311-80G02
24.0117-0109.1	417109					V	287,0	17,0	15,0	29,0	140,0	5	108,2	181,7	13,0	SUZUKI 55211-65D01
24.0118-0101.1	418101					V	238,0	18,0	16,0	31,0	94,0	4	75,0	143,5	10,5	MAZDA B107-33-251 BF68-33-251A
24.0118-0104.1	418104					V	242,0	18,0	16,0	43,9	90,0	4	70,0	100,0	M10	SUBARU 25431GA171 25431GA200



Abmessungen Bremsscheiben

Dimensions brake discs - Misure dischi freno -

Dimensions Disques de frein - Medidas disco de freno

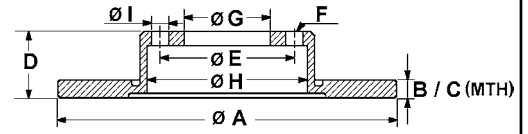

S Fixierschraube - fixing screw - vite di riparazione - vis de fixation - tornillo quejija

B beschichtet - coated - rivestito - revêtu - recubierto

HC hochgekohlt - high carbon - ad alto tenore di carbonio - à haute teneur en carbone - altamente carbonizado

L legiert - alloyed - alligato/legato - allié - aleado

V ventiliert - ventilated - ventilato - ventilé - ventilado

● gelocht - perforated - perforato - poinçonné - perforado

		S	B	H	C	L	V	A	B	C	D	E	F	G	H	I	OE - #	
24.0118-0105.1	418105		B					282,0	18,0	15,0	64,5	112,0	5	68,2	144,0	16,5	VOLKSWAGEN	701 615 301 E
24.0118-0106.1	418106	S	B	HC		V		239,0	18,0	16,0	34,5	100,0	4	65,0	125,0	13,6	SEAT/VW	6N0 615 301 C
24.0118-0107.1	418107		B			V		240,0	18,0	16,0	45,2	100,0	4	61,0	130,0	12,6	VOLKSWAGEN	6N0 615 301 F
24.0118-0108.1	418108		B					280,0	18,0	15,9	65,5	118,0	5	73,0	141,3	15,5	NISSAN	40206-58A00
24.0118-0109.1	418109					V		242,0	18,0	16,4	34,0	104,0	4	86,0	126,0	10,6	TOYOTA	40206-58A01
24.0118-0110.1	418110					V		238,0	18,0	17,0	48,2	100,0	4	54,1	127,0	14,5	NISSAN	40206-60Y01
24.0118-0111.1	418111	S	B	HC				282,0	18,0	15,0	55,0	112,0	5	68,2	144,0	16,5	CITROEN	4246 J9
24.0118-0112.1	418112					V		236,0	18,0	16,4	34,0	104,0	4	86,0	141,0	10,6	FIAT	1300500080
24.0118-0113.1	418113		B			V		235,0	18,0	16,0	45,0	100,0	4	55,0	125,0	13,0	PEUGEOT	4246 J8
24.0118-0115.1	418115					V		212,0	18,0	15,5	36,5	94,0	4	65,1	99,0	M10x1,25	MITSUBISHI	MB316677
24.0118-0116.1	418116					V		240,0	18,0	15,5	36,5	94,0	4	65,1	150,5	M10x1,25	MB366434	
24.0118-0117.1	418117					V		247,0	18,0	16,0	45,2	100,0	4	61,0	130,0	12,7	TOYOTA	43512-12250
24.0118-0118.1	418118					V		232,0	18,0	16,0	45,2	100,0	4	61,0	130,0	12,8	TOYOTA	43512-12300
24.0118-0119.1	418119					V		291,0	18,0	17,0	68,4	114,3	5	60,0	190,0	14,5	TOYOTA	43512-12310
24.0118-0120.1	418120		B			V		236,0	18,0	16,4	45,0	100,0	4	64,0	126,0	12,6	TOYOTA	43512-12330
24.0118-0121.1	418121					V		277,0	18,0	17,0	32,5	118,0	5	96,0	176,0	10,6	TOYOTA	43512-12440
24.0118-0122.1	418122		B			V		313,5	18,0	16,6	80,2	139,6	6	101,0	210,0	12,6	MITSUBISHI	43512-12480
24.0118-0124.1	418124		B			V		238,0	18,0	17,0	42,8	100,0	4	55,0	127,0	14,6	VOLKSWAGEN	701 615 301 G
24.0118-0125.1	418125					V		242,0	18,0	16,0	52,5	100,0	5	58,0	128,0	13,0	MITSUBISHI	MB618734
24.0118-0126.1	418126					V		234,5	18,0	17,0	47,0	100,0	4	56,0	128,5	13,0	MITSUBISHI	MB618735
24.0118-0129.1	418129		B			V		302,0	18,0	16,0	46,2	114,3	5	62,0	156,7	14,6	MAZDA	NA01-33-25X
24.0118-0131.1	418131		B			V		235,0	17,9	16,0	43,2	100,0	4	55,0	129,5	14,5	MAZDA	NA01-33-25XA
24.0118-0136.1	418136					V		316,0	18,0	16,0	80,0	139,7	6	111,0	189,0	12,8	MAZDA	NA01-33-25XC
24.0118-0137.1	418137	S	B	HC		V		239,0	18,0	16,0	35,0	100,0	5	65,0	125,0	15,6	SUBARU	725431150
24.0118-0138.1	418138		B			V		234,0	18,0	16,0	50,7	100,0	4	62,2	126,0	12,6	SUBARU	725431312
24.0118-0139.1	418139		B			V		238,0	18,0	16,0	46,2	100,0	4	59,0	130,0	12,5	SUBARU	725431321
24.0118-0140.1	418140		B			V		315,0	18,0	16,4	84,2	139,7	6	108,0	197,0	12,5	NISSAN	40206-0M802
24.0118-0141.1	418141					V		266,0	18,0	16,4	60,2	114,3	4	90,0	168,0	12,6	NISSAN	40206-0M602
24.0118-0143.1	418143		B			V		329,2	18,0	16,0	102,6	150,0	5	110,0	230,0	16,7	TOYOTA	42431-14110
24.0118-0144.1	418144		B			V		252,0	18,0	16,0	49,0	100,0	4	62,2	126,0	12,6	MITSUBISHI	MB699283
24.0118-0145.1	418145		B			V		241,0	18,0	16,0	49,0	100,0	4	62,2	126,0	12,6	MITSUBISHI	MB950922
24.0118-0146.1	418146		B			V		332,0	18,0	16,0	74,4	139,7	6	94,0	210,0	12,8	MITSUBISHI	MR449769
24.0118-0147.1	418147		B			V		310,0	18,0	16,5	67,2	114,3	5	62,0	190,0	14,5	PROTON	MB699283
24.0118-0148.1	418148		B			V		286,0	18,0	16,0	58,7	114,3	5	72,0	190,0	13,0	DAIHATSU	43512-87608-000
24.0118-0149.1	418149		B			V		302,0	18,0	16,0	43,3	114,3	5	72,0	142,8	13,0	DAIHATSU	97034036
24.0118-0150.1	418150		B			V		301,6	18,0	16,0	56,6	114,3	5	72,0	190,0	13,0	ISUZU	97034036
24.0118-0151.1	418151		B			V		256,0	18,0	16,0	46,9	100,0	4	62,2	126,0	12,5	OPEL/VAUXHALL	5 69 104/97034036
24.0118-0153.1	418153		B					302,0	18,0	15,0	51,0	140,0	8	120,0	164,0	10,9	OPEL/VAUXHALL	5 69 106/91151563
																	TOYOTA	43512-16070
																	TOYOTA	43512-16120
																	DAIHATSU	26310AA012
																	DAIHATSU	43512-87710-000
																	TOYOTA	43512-87718-000
																	TOYOTA	43512-87725-000
																	TOYOTA	43512-42010
																	TOYOTA	43512-0D010
																	NISSAN	43512-52050
																	NISSAN	43206-05J04
																	SKODA/VW	43206-VB000
																	SKODA/VW	6Q0 615 301
																	VOLKSWAGEN	6Q0 615 301 A
																	HYUNDAI	51712-02551
																	NISSAN	40206-1F500
																	NISSAN	40206-72B00
																	MITSUBISHI	MB618797
																	HYUNDAI	58411-M2050
																	KIA	58411-M2050
																	LEXUS/TOYOTA	42431-60220
																	LEXUS/TOYOTA	42431-60221
																	LEXUS/TOYOTA	42431-60280
																	LEXUS/TOYOTA	42431-60281
																	HYUNDAI	51712-0X700
																	HYUNDAI	51712-B9000
																	KIA	51712-07700
																	HYUNDAI	51712-0X500
																	KIA	51712-07500
																	MITSUBISHI	4615A037
																	LEXUS	42431-30290
																	MAZDA	LE44-26-251A
																	MAZDA	F151-26-251A
																	MAZDA	L206-26-251B
																	HYUNDAI	51712-1J500
																	OPEL/VAUXHALL	44 21 180/93168942
																	NISSAN	43206-00Q0C
																	RENAULT	43 20 679 43R



Abmessungen Bremsscheiben

Dimensions brake discs - Misure dischi freno -

Dimensions Disques de frein - Medidas disco de freno

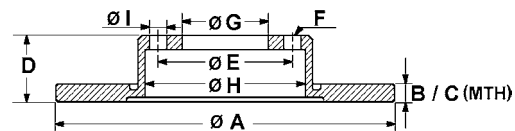

S Fixierschraube - fixing screw - vite di riparazione - vis de fixation - tornillo quefija L legiert - alloyed - alligato/legato - allié - aleado ● gelocht - perforated - perforato - poinçonné - perforado
 B beschichtet - coated - rivestito - revêtu - recubierto V ventiliert - ventilated - ventilato - ventilé - ventilado

HC hochgekohlt - high carbon - ad alto tenore di carbonio - à haute teneur en carbone - altamente carbonizado

			S	B	H	C	L	V	A	B	C	D	E	F	G	H	I		OE - #				
24.0118-0154.1	418154							V	324,0	18,0	16,0	67,0	114,3	5	69,0	210,0	12,5		HYUNDAI	58411-3J500			
24.0118-0158.1	418158							V	324,6	18,0	16,0	56,7	114,3	5	72,0	190,0	13,0		MAZDA	L232-26-251C			
24.0118-0709.1	418709							V	312,0	18,0	16,0	68,0	139,7	6	106,0	210,0	14,5		TOYOTA	42431-60200			
																			LEXUS/TOYOTA	42431-60201			
24.0118-0724.1	418724							V	308,0	18,0	16,0	62,7	114,3	5	68,0	190,0	12,7		NISSAN	43206-EB300			
24.0118-0725.1	418725							V	290,0	18,0	16,0	67,4	100,0	5	58,0	170,0	13,0		SUBARU	26700AE080			
																				26700AE081			
24.0119-0104.1	419104							V	242,0	19,0	17,0	49,6	100,0	4	61,0	126,7	12,6		HONDA	45251-SE0-010			
24.0119-0106.1	419106							V	242,0	19,0	17,0	44,1	100,0	4	61,0	122,0	12,6		HONDA	45251-SB2-990			
24.0119-0107.1	419107		S	B				HC	V	276,0	19,0	17,4	60,3	120,0	5	75,0	160,8	14,5		BMW	34 21 6 855 155		
																				34 21 6 864 903			
24.0119-0108.1	419108		S	B				HC	V	294,0	18,9	17,4	59,7	120,0	5	75,0	160,8	14,8		BMW	34 21 1 165 563		
																				34 21 6 864 056			
24.0119-0109.1	419109							V	242,0	19,1	17,0	40,5	104,0	4	86,0	143,0	M10x1,25		HYUNDAI	51712-24100			
24.0119-0111.1	419111							V	242,0	19,2	17,0	37,2	104,0	4	86,0	126,0	10,4		HYUNDAI	51712-28000			
																				51712-28000D			
24.0119-0112.1	419112		S	B				HC	V	294,0	19,0	17,4	74,7	120,0	5	75,0	160,8	14,7		BMW	34 21 6 794 303		
24.0119-0113.1	419113		S	B				HC	V	294,0	19,0	17,4	60,5	120,0	5	75,0	184,0	14,7		BMW	34 21 1 166 165		
24.0119-0114.1	419114							B	V	241,0	19,0	17,0	52,1	100,0	4	62,2	126,0	12,5		HYUNDAI	51712-25060		
																				51712-25061			
24.0119-0115.1	419115							B	V	241,0	19,0	17,0	47,8	100,0	4	62,2	126,0	12,5		NISSAN	51712-1C000		
24.0119-0116.1	419116							B	V	256,0	19,0	17,0	47,9	100,0	4	62,2	125,0	12,5		HYUNDAI	51712-1C050		
24.0120-0103.1	420103								HC	L	V	282,5	20,5	19,1	35,3	126,0	5	107,0	145,0	8,4		PORSCHE	477 405 083 A
																				911 351 041 20			
24.0120-0104.1	420104								HC	L	V	289,0	20,0	18,6	100,0	130,0	5	103,0	180,0	15,4		PORSCHE	944 352 041 03
24.0120-0108.1	420108										V	260,0	20,0	18,0	54,0	98,0	5	58,0	127,0	13,0		CITROEN	5 429 669 S
																				75 529 364			
24.0120-0112.1	420112								HC	L	V	289,0	19,9	18,7	71,2	130,0	5	102,8	180,0	15,6		PORSCHE	944 352 041 02
24.0120-0113.1	420113								HC	V	300,0	20,0	18,4	68,0	120,0	5	75,0	180,0	14,5		BMW	34 21 1 162 967	
24.0120-0114.2	420114										V	281,0	19,9	18,0	80,5	115,0	5	91,0	128,5	M14x1,5		VOLKSWAGEN	281 615 283 A
24.0120-0115.1	420115		S	B				HC	L	V	236,0	20,0	17,0	41,0	100,0	4/6	60,0	123,0	14,0		CHEVROLET	90121445	
																				DAEWOO	90121445		
24.0120-0119.1	420119										V	295,0	20,0	18,0	29,0	137,0	6	104,0	178,0	M12x1,25		OPEL/VAUXHALL	5 69 054/9051111
																				NISSAN	40206-37J01		
																					40206-C7000		
																					40206-C7001		
																					40206-G9500		
24.0120-0120.1	420120								HC	V	256,0	20,0	18,0	41,9	108,0	4	68,0	134,0	15,4		AUDI	853 615 301 A	
																					853 615 301 C		
24.0120-0122.1	420122										V	308,0	20,0	18,0	64,5	108,0	5	68,0	178,0	16,5		VOLVO	8624926
24.0120-0123.1	420123		S	B				HC	L	V	239,0	20,0	18,0	39,0	100,0	4	65,0	123,8	13,6		AUDI/SEAT/VW	321 615 301 C	
24.0120-0125.1	420125		S	B					V	238,0	20,1	17,7	41,0	100,0	4	61,0	128,0	12,5		NISSAN	40206-00QAJ		
																				RENAULT	77 01 204 286		
																					86 71 000 085		
24.0120-0126.1	420126										V	259,0	20,2	17,7	46,4	100,0	4	61,0	130,0	12,8		RENAULT	77 00 715 081
																					77 01 204 283		
24.0120-0128.1	420128		S	B				HC	L	V	256,0	20,0	18,0	38,8	100,0	4	65,0	131,5	13,8		SEAT/VW	321 615 301 D	
																					6N0 615 301 D		
24.0120-0129.1	420129										V	257,4	20,0	18,2	51,7	98,0	4	59,0	127,0	13,0		ALFA/FIAT/LANCIA	60810227
																					82464702		
24.0120-0130.1	420130										V	255,0	20,0	18,4	45,0	108,0	6	87,0	115,0	10,5		NISSAN	MB151387
24.0120-0131.1	420131										V	247,0	20,4	18,5	44,2	108,0	4	66,0	133,2	12,8		CITROEN	91 517 694
																					PEUGEOT	4246 A6	
24.0120-0132.1	420132		S	B					V	247,0	20,4	18,5	34,2	108,0	4	66,0	133,2	12,8		CITROEN	95 661 747		
																					PEUGEOT	4246 A7	
																					4249 96		
24.0120-0133.1	420133		S	B					V	266,0	20,5	18,5	27,6	108,0	4	66,0	133,0	13,0		CITROEN	4249 F0		
																					PEUGEOT	E169002	
																					PEUGEOT	4246 97	
																					4249 F0		
24.0120-0134.1	420134										V	265,0	20,5	17,7	31,6	100,0	4	61,0	127,0	12,8		RENAULT	77 00 764 193
																					77 01 467 955		
24.0120-0135.1	420135										V	244,0	20,5	17,7	31,6	100,0	4	61,0	127,0	12,5		RENAULT	77 00 758 901
																					77 01 204 954		
																					77 01 467 954		
24.0120-0137.1	420137										V	269,0	19,9	18,0	46,0	112,0	5	68,0	156,0	15,5		AUDI	447 615 601 A
24.0120-0139.1	420139										V	255,5	20,0	18,4	33,5	104,0	5	84,0	84,5	10,6		NISSAN	MB238495
24.0120-0140.1	420140		S	B				HC	L	V	256,0	20,0	17,0	41,0	100,0	4/6	60,0						

Abmessungen Bremsscheiben

Dimensions brake discs - Misure dischi freno -

Dimensions Disques de frein - Medidas disco de freno

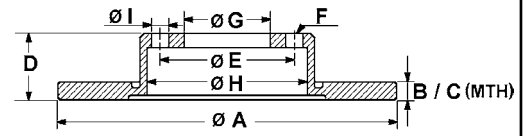

S Fixierschraube - fixing screw - vite di riparazione - vis de fixation - tornillo quefija
 B beschichtet - coated - rivestito - revêtu - recubierto
 HC hochgekohlt - high carbon - ad alto tenore di carbonio - à haute teneur en carbone - altamente carbonizado
 L legiert - alloyed - alligato/legato - allié - aleado
 V ventiliert - ventilated - ventilato - ventilé - ventilado
 ● gelocht - perforated - perforato - poinçonné - perforado

		S	B	HC	L	V	A	B	C	D	E	F	G	H	I	OE	- #	
24.0120-0142.1	420142		B		HC	L	V	257,5	20,0	18,2	40,5	98,0	4	59,0	126,7	13,0	ALFA/FIAT/LANCIA	7779409 71738145 51749124 60806137 60810076 60811256 60811266
24.0120-0143.1	420143						V	240,0	20,0	18,2	46,5	98,0	4	59,0	124,5	13,0	FIAT	7650707
24.0120-0146.1	420146		B				V	253,0	20,0	18,0	43,7	108,0	4	63,5	153,0	13,7	FORD	4115996 5026786
24.0120-0147.1	420147		B				V	239,5	20,0	18,0	43,0	108,0	4	63,5	136,0	13,7	FORD/MAZDA	1019604 1066271 1320581 1320582 5028281
24.0120-0148.1	420148						V	238,0	20,1	17,7	46,0	100,0	4	61,0	132,0	12,5	RENAULT	77 01 466 782
24.0120-0152.1	420152						V	242,0	20,0	18,0	49,2	114,3	4	68,0	138,0	12,5	NISSAN	40206-90J01
24.0120-0153.1	420153						V	302,0	20,0	19,0	48,0	139,7	6	100,0	166,5	15,0	TOYOTA	43512-60011 43512-60040 43512-69015 43512-69016
24.0120-0154.1	420154		S	B	HC		V	298,0	20,0	18,4	61,3	120,0	5	75,0	185,0	14,5	BMW	34 21 1 164 175 34 21 6 767 060
24.0120-0155.1	420155		B		HC	L	V	257,5	20,0	18,2	40,5	98,0	5	59,0	126,7	16,5	CITROEN	4249 L4
24.0120-0157.1	420157						V	251,0	20,0	18,0	45,8	98,0	4	62,0	159,5	13,0	PEUGEOT	4246 H8
24.0120-0159.1	420159						V	257,0	20,0	18,2	40,5	98,0	5	59,0	126,4	13,2	SEAT	SE021165002A
24.0120-0162.1	420162						V	243,0	20,0	18,0	42,5	100,0	4	57,0	136,0	13,0	ALFA/FIAT	46425960
24.0120-0163.1	420163						V	235,0	20,0	18,0	49,5	100,0	4	60,0	125,2	12,7	KIA	0K20A-33-251A
24.0120-0166.1	420166						V	253,0	20,0	18,4	28,6	104,0	5	84,0	148,0	10,6	SUZUKI	55311-61G01
24.0120-0168.1	420168						V	289,0	20,0	18,0	64,2	127,0	6	100,0	156,0	10,7	HYUNDAI	58129-44010
24.0120-0169.1	420169						V	255,0	20,0	18,0	45,0	100,0	4	55,0	125,0	13,0	TOYOTA	43512-35190
24.0120-0171.1	420171		B				V	286,0	20,0	18,0	67,0	110,0	5	65,5	160,0	14,0	VOLKSWAGEN	J43 512 351 90
24.0120-0172.1	420172		B				V	269,0	19,9	18,0	59,5	112,0	5/10	68,0	156,0	15,3	MAZDA	N026-33-25X
24.0120-0173.1	420173		S	B			V	292,0	19,9	18,0	41,4	110,0	5	65,5	162,5	14,0	OPEL/VAUXHALL	5 69 100/9195052
24.0120-0174.1	420174				HC	L	V	269,0	19,9	18,0	59,5	112,0	5/10	68,0	156,0	15,3	AUDI	857 615 601
24.0120-0175.1	420175		B				V	255,0	20,0	18,0	43,1	100,0	4	55,0	129,0	14,5	FIAT	46836490 71772548
24.0120-0176.1	420176		B				V	240,0	20,0	17,0	41,0	100,0	4/6	60,0	126,0	14,0	OPEL/VAUXHALL	5 69 021/9195985
24.0120-0177.1	420177		B				V	242,0	20,0	18,0	43,5	100,0	4	57,0	136,0	13,0	SAAB	9191336 12762291
24.0120-0178.1	420178		B		HC		V	324,0	20,0	18,4	67,0	120,0	5	79,0	185,0	16,5	OPEL/VAUXHALL	5 69 114/93171778
24.0120-0180.1	420180		S	B			V	247,0	20,0	18,0	35,3	100,0	4	55,0	129,0	13,2	SAAB	9191336 12762291
24.0120-0181.1	420181		B				V	300,0	20,0	18,4	61,0	120,0	5	75,0	180,0	14,5	SAAB	9191336 12762291
24.0120-0182.1	420182		S	B			V	328,0	20,0	18,4	61,0	120,0	5	75,0	180,0	14,5	TOYOTA	43512-0H010 43512-0H020
24.0120-0183.1	420183		S	B			V	320,0	20,0	18,4	63,2	120,0	5	75,0	185,0	14,5	BMW	34 21 1 165 265
24.0120-0184.1	420184		B				V	240,5	20,0	18,2	40,5	98,0	4	59,0	146,5	13,0	BMW	34 21 6 767 062
24.0120-0185.1	420185						V	290,0	20,0	18,7	83,0	130,0	5	90,0	180,0	15,4	BMW	34 21 6 772 085
24.0120-0186.1	420186						V	239,0	19,5	18,0	41,8	98,0	4	58,5	154,0	13,0	FIAT	46788929 51742727
24.0120-0187.1	420187						V	260,0	20,0	18,5	42,0	98,0	4	58,5	174,0	13,0	FORD	1541806 9S51 1125-DA
24.0120-0188.1	420188		B				V	305,0	20,0	18,5	67,9	120,7	5	73,8	180,0	13,3	PORSCHE	901 352 041 14
							V	239,0	19,5	18,0	41,8	98,0	4	58,5	154,0	13,0	LADA	2110-3501070
							V	260,0	20,0	18,5	42,0	98,0	4	58,5	174,0	13,0	LADA	2112-3501070
							V	305,0	20,0	18,5	67,9	120,7	5	73,8	180,0	13,3	JAGUAR	JLM 11904 JLM 12428 JLM 20342



Abmessungen Bremsscheiben

Dimensions brake discs - Misure dischi freno -

Dimensions Disques de frein - Medidas disco de freno

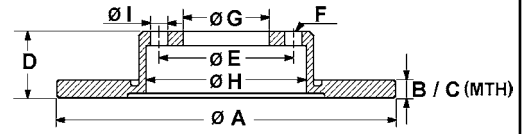

S Fixierschraube - fixing screw - vite di riparazione - vis de fixation - tornillo quejija
 B beschichtet - coated - rivestito - revêtu - recubierto
 HC hochgekohlt - high carbon - ad alto tenore di carbonio - à haute teneur en carbone - altamente carbonizado
 L legiert - alloyed - alligato/legato - allié - aleado
 V ventiliert - ventilated - ventilato - ventilé - ventilado
 ● gelocht - perforated - perforato - poinçonné - perforado

		S	B	HC	L	V	A	B	C	D	E	F	G	H	I	OE - #	
24.0120-0189.1	420189	S	B	HC		V	312,0	20,0	18,4	61,0	120,0	5	75,0	180,0	14,5	BMW	34 21 2 227 177
24.0120-0190.1	420190	S	B	HC		V	312,0	20,0	18,4	61,0	120,0	5	75,0	180,0	14,5	BMW	34 21 2 227 178
24.0120-0191.1	420191		B	HC		V	324,0	20,0	18,4	80,3	120,0	5	75,0	185,0	16,6	BMW	34 21 6 756 849
24.0120-0193.1	420193					V	240,0	20,0	18,2	46,5	98,0	4	59,0	124,5	13,2	FIAT	46419204
24.0120-0195.1	420195	S	B	HC		V	300,0	20,0	18,4	66,0	120,0	5	75,0	160,8	14,5	BMW	34 21 6 855 007
24.0120-0196.1	420196	S	B			V	300,0	20,0	18,0	69,1	110,0	5	65,5	160,0	14,2	SAAB	5232756 12763593
24.0120-0197.1	420197					V	246,0	20,0	18,0	50,0	100,0	4	60,0	125,0	12,8	SUZUKI	55311-62G02 55311-62G03
24.0120-0199.1	420199			HC	L	V	278,0	19,9	17,4	55,2	112,0	5	67,0	164,0	15,0	MERCEDES BENZ	124 423 10 12
24.0120-0200.1	420200		B	HC	L	V	354,0	20,0	17,0	74,9	120,0	5	79,0	210,0	16,6	LAND ROVER	SDB500201 SDB500202 LR031844
24.0120-0201.1	420201		B			V	350,0	20,0	17,0	59,0	120,0	5	79,0	210,0	15,0	LAND ROVER	SDB000644 SDB000645 SDB000646
24.0120-0202.1	420202					V	315,0	20,0	18,4	87,5	139,7	5	96,3	190,0	12,5	KIA	58411-3E300
24.0120-0203.1	420203		B			V	252,0	20,0	18,0	45,2	100,0	4	61,0	144,0	12,6	NISSAN	40206-2N301
24.0120-0204.1	420204	S	B	HC		V	300,0	20,0	18,4	66,1	120,0	5	75,0	185,0	14,5	BMW	34 21 6 864 901
24.0120-0206.1	420206	S	B	HC		V	320,0	19,9	18,4	78,5	120,0	5	75,0	185,0	16,5	BMW	34 21 6 868 940
24.0120-0207.1	420207		B			V	315,0	20,0	18,4	78,5	139,7	5	96,3	190,0	12,5	KIA	58411-3E500
24.0120-0208.1	420208	S	B	HC	L	V	300,0	22,0	19,4	57,5	112,0	5	67,0	164,0	15,3	MERCEDES BENZ	000 423 12 12
24.0120-0209.1	420209		B	HC	L	V	303,0	20,0	18,4	71,6	115,0	5	70,7	190,0	12,8	CHEVROLET	96625873 20968395 4801857
24.0120-0210.1	420210		B			V	325,0	20,0	17,0	59,0	120,0	5	79,0	210,0	15,0	OPEL/VAUXHALL LAND ROVER	48 04 637/96625873 SDB000634 SDB000635 SDB000636
24.0120-0211.1	420211	S	B			V	252,0	20,0	18,0	40,0	100,0	4	60,0	127,0	12,5	OPEL/VAUXHALL SUZUKI	47 00 455/95513700 55311-62J00
24.0120-0212.1	420212		B	HC	L	V●	299,0	20,0	18,0	67,0	130,0	5	98,0	180,0	15,4	PORSCHE	987 352 401 01
24.0120-0213.1	420213	S	B	HC		V	320,0	20,0	18,4	86,1	120,0	5	75,0	185,0	14,5	BMW	34 21 6 763 345
24.0120-0214.1	420214	S	B	HC		V	300,0	20,0	18,4	76,0	120,0	5	75,0	160,8	14,5	BMW	34 21 6 855 005
24.0120-0215.1	420215	S	B	HC		V	300,0	20,0	18,4	76,2	120,0	5	75,0	185,0	14,5	BMW	34 21 6 778 049
24.0120-0216.1	420216		B			V	276,0	20,0	18,0	40,0	114,3	5	62,0	146,5	12,7	SUZUKI	55311-57K01 55312-57K01
24.0120-0217.1	420217		B	HC		V	324,0	20,0	18,4	74,0	120,0	5	79,0	185,0	16,5	BMW	34 21 6 765 887
24.0120-0218.1	420218		B			V	302,0	20,0	18,0	66,0	108,0	5	63,6	185,0	15,8	LAND ROVER	LR001019
24.0120-0219.1	420219		B			V	255,0	20,0	18,0	46,2	100,0	4	55,0	131,0	14,5	ASTON MARTIN	43512-74010
24.0120-0225.1	420225		B			V	231,0	20,0	18,0	51,4	100,0	4	60,0	125,0	12,7	TOYOTA NISSAN SUZUKI	43512-74010 40206-4A00G 55311M68K10
24.0120-0226.1	420226	S	B	HC		V	300,0	20,0	18,4	54,2	120,0	5	75,0	174,0	14,5	BMW	34 21 6 782 605
24.0120-0227.1	420227		B	HC		V	236,0	20,0	18,0	41,0	100,0	6	59,0	123,0	12,4	CHEVROLET/DAEWOO	96471274
24.0120-0228.1	420228	S	B	HC		V	324,0	20,0	18,4	54,1	120,0	5	75,0	174,0	14,5	BMW	34 21 6 782 607
24.0120-0229.2	420229	S	B	HC		V	330,0	20,0	18,4	68,8	120,0	5	75,0	185,0	16,5	BMW	34 21 6 775 287
24.0120-0232.1	420232		B			V	303,0	20,0	18,4	92,5	120,0	5	79,0	190,0	14,5	HYUNDAI	58329-4A350
24.0120-0234.1	420234	S	B	HC		V	330,0	20,0	18,4	71,0	120,0	5	75,0	154,0	16,5	BMW	34 20 6 868 936
24.0120-0235.1	420235		B			V	303,0	20,0	18,4	92,5	140,0	6	75,0	190,0	12,3	HYUNDAI	58329-4A450
24.0120-0237.1	420237	S	B	HC		V	300,0	20,0	18,4	66,0	120,0	5	75,0	160,8	16,5	BMW	34 21 6 792 227
24.0120-0238.1	420238		B	HC		V	326,0	20,0	18,0	38,0	108,0	5	64,5	160,4	14,0	JAGUAR	C2C 25339 C2D 26352
24.0120-0243.1	420243	S	B	HC		V	330,0	20,0	18,4	66,2	120,0	5	75,0	185,0	16,5	BMW	34 21 6 864 899
24.0120-0708.1	420708		B			V	288,0	20,0	18,5	32,5	108,0	5	64,5	160,0	14,0	JAGUAR	JLM 20802 XR8 27087
24.0121-0100.1	421100					V	285,0	21,0	19,0	51,2	114,3	4	64,1	141,0	12,7	HONDA ROVER	45251-SG9-000 GBD90800 GBD90822
24.0121-0101.1	421101					V	285,0	21,0	19,0	31,8	108,0	5	61,0	134,0	14,5	RENAULT	77 00 801 101 77 01 204 298
24.0121-0102.1	421102					V	262,0	21,0	19,0	51,2	100,0	4	64,2	141,0	12,6	HONDA	45251-SF0-000
24.0121-0103.1	421103					V	285,0	21,0	19,0	31,8	100,0	4	61,0	134,0	12,5	RENAULT	77 00 801 213 77 01 204 299
24.0121-0104.1	421104	S	B			V	240,0	21,0	19,0	44,8	100,0	4	61,0	126,0	13,0	HONDA	45251-SH1-A00 45251-SH3-A00 45251-SR3-A10

Abmessungen Bremsscheiben

Dimensions brake discs - Misure dischi freno -

Dimensions Disques de frein - Medidas disco de freno

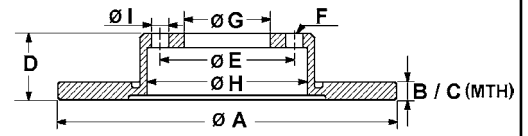

S Fixierschraube - fixing screw - vite di riparazione - vis de fixation - tornillo quefija

B beschichtet - coated - rivestito - revêtu - recubierto

HC hochgekohlt - high carbon - ad alto tenore di carbonio - à haute teneur en carbone - altamente carbonizado

L legiert - alloyed - alligato/legato - allié - aleado

V ventiliert - ventilated - ventilato - ventilé - ventilado

● gelocht - perforated - perforato - poinçonné - perforado

		S	B	HC	L	V	A	B	C	D	E	F	G	H	I	OE	#
24.0121-0105.1	421105	S	B			V	262,0	21,0	19,0	44,7	100,0	4	64,1	141,0	13,0	HONDA	45251-S5D-A10 45251-S6D-E10 45251-SCC-901 45251-SK7-A00 45251-SK7-A10 45251-SR0-A00 45251-SR0-A10 45251-ST3-E10 45251-TF3-E00 45251-TG5-H00 GBD90840 SDB000990
24.0121-0106.1	421106	S	B			V	259,0	20,7	17,7	41,0	100,0	4	61,0	130,0	12,7	NISSAN DACIA/RENAULT	40206-00QAA 60 01 548 578 77 00 842 131 77 01 204 828 77 01 206 339 77 11 130 038 86 71 005 976
24.0121-0107.1	421107					V	262,0	21,0	19,0	47,2	100,0	4	64,1	141,0	13,0	HONDA ROVER	45251-SK3-E00 GBD90830
24.0121-0110.1	421110					V	262,0	21,0	18,0	51,0	114,3	4	64,1	141,0	12,6	ROVER	GBD90801
24.0121-0112.1	421112		B	HC	L	V	282,0	20,5	19,0	74,2	130,0	5	103,0	155,0	15,4	PORSCHE	944 351 041 05
24.0121-0113.1	421113	S	B			V	240,0	21,0	19,0	39,2	100,0	4	61,0	126,5	13,0	HONDA	45251-S50-G00 45251-SAA-G11
24.0121-0114.1	421114		B			V	277,0	21,0	18,0	51,0	114,3	5	66,1	141,0	12,5	LAND ROVER	SDB101070
24.0121-0115.1	421115	S	B			V	258,0	21,0	19,0	39,2	100,0	4	64,1	141,3	12,6	HONDA	45251-SAA-G50
24.0121-0702.1	421702	S	B			V	262,0	21,0	19,0	47,2	114,3	5	64,2	141,0	12,6	HONDA	45251-S6M-000 45251-SNA-000
24.0122-0100.1	422100		B	HC		V	280,0	22,0	20,0	28,5	100,0	5	65,0	141,0	15,6	SEAT/VW	1H0 615 301 A
24.0122-0101.1	422101		B	HC		V	280,0	22,0	20,0	39,5	100,0	4	65,0	137,0	13,6	SEAT/VW	535 615 301
24.0122-0103.1	422103	S	B	HC		V	302,0	22,0	20,4	76,0	120,0	5	79,0	149,0	14,5	BMW	34 11 1 160 936
24.0122-0106.1	422106					V	278,0	22,0	20,0	66,3	112,0	5	80,0	127,5	15,0	MERCEDES BENZ	116 420 02 05
24.0122-0107.1	422107		B			V	284,0	22,0	20,2	39,4	98,0	4	59,0	127,0	13,0	ALFA/FIAT/LANCIA	46403958 46427947 46427949 60811890 60812067 60812137
24.0122-0108.1	422108		B	HC		V	256,0	22,0	20,0	56,5	108,0	4	68,0	132,7	15,4	AUDI	895 615 301 A
24.0122-0109.1	422109					V	271,0	22,0	19,0	59,4	108,0	5	88,0	130,0	10,5	OPEL/VAUXHALL	5 69 029/90008004
24.0122-0111.1	422111					V	280,0	22,0	20,4	78,0	120,0	5	74,0	143,0	14,5	BMW	34 11 1 119 563 34 11 1 163 130
24.0122-0112.1	422112					V	255,0	22,0	20,4	75,0	100,0	4	63,0	128,0	14,5	BMW	34 11 1 163 126
24.0122-0115.1	422115	S	B	HC		V	286,0	22,0	20,4	51,5	120,0	5	79,0	147,5	14,5	BMW	34 11 1 165 455 34 11 6 766 239 34 11 6 794 301 34 11 6 864 060
24.0122-0116.1	422116					V	278,0	22,0	19,4	68,3	112,0	5	80,0	127,5	15,0	MERCEDES BENZ	126 420 00 05 126 421 00 12
24.0122-0118.1	422118		B			V	256,0	22,0	20,0	46,5	108,0	4	68,0	132,7	15,4	AUDI	443 615 301 B
24.0122-0119.2	422119					V	269,0	22,0	20,0	51,5	98,0	5	72,0	120,0	M12x1,5	ALFA ROMEO	60522092
24.0122-0120.1	422120			HC	L	V	280,0	22,0	20,0	46,5	112,0	5	68,0	158,0	15,4	AUDI	437 615 301 A
24.0122-0122.1	422122		B	HC	L	V	260,0	22,0	20,4	35,0	100,0	4	66,0	138,0	14,5	BMW	34 11 1 160 915
24.0122-0123.1	422123	S	B	HC	L	V	284,0	22,0	19,4	43,5	112,0	5	67,0	154,3	15,0	MERCEDES BENZ	124 421 16 12 124 421 27 12
24.0122-0124.1	422124		B	HC	L	V	262,0	22,0	19,4	44,5	112,0	5	67,0	142,5	15,0	MERCEDES BENZ	201 421 15 12
24.0122-0126.1	422126					V	271,0	22,0	19,0	59,4	108,0	5	94,0	130,0	10,5	OPEL/VAUXHALL	5 69 032/90008007
24.0122-0127.1	422127					V	263,0	22,0	20,4	67,3	108,0	5	68,0	139,0	16,5	VOLVO	270739
24.0122-0128.1	422128					V	239,2	22,0	20,2	46,1	98,0	4	58,5	127,4	13,0	ALFA ROMEO	60514881
24.0122-0129.1	422129					V	250,0	22,0	20,0	49,2	114,3	4	68,0	144,0	12,5	NISSAN	40206-15E00 40206-15E01
24.0122-0130.1	422130					V	257,2	22,0	20,2	50,7	98,0	4	59,0	127,0	13,2	ALFA/FIAT/LANCIA	46445005 60805172 60807625
24.0122-0132.1	422132	S	B	HC	L	V	284,0	22,0	19,4	43,5	112,0	5	67,0	154,3	12,8	MERCEDES BENZ	202 421 09 12
24.0122-0133.1	422133			HC		V	300,0	22,0	19,4	60,0	112,0	5	67,0	164,0	17,0	MERCEDES BENZ	140 423 04 12
24.0122-0134.1	422134		B	HC	L	V	284,0	22,0	19,4	43,5	112,0	5	67,0	152,0	15,0	MERCEDES BENZ	124 421 23 12
24.0122-0135.1	422135					V	284,0	22,0	20,4	76,0	120,0	5	79,0	147,0	14,5	BMW	34 11 1 163 136
24.0122-0136.1	422136		B	HC	L	V	295,0	22,0	19,4	49,5	112,0	5	67,0	154,3	15,0	MERCEDES BENZ	124 421 15 12
24.0122-0137.1	422137					V	287,0	22,0	20,0	56,0	108,0	5	68,0	157,0	14,0	VOLVO	1359908
24.0122-0138.1	422138					V	262,5	22,0	20,0	56,0	108,0	5	68,0	139,0	14,0	VOLVO	1359906
24.0122-0139.1	422139		B	HC		V	280,0	22,0	20,0	56,5	108,0	4	68,0	146,0	15,4	AUDI	8A0 615 301 E

Abmessungen Bremsscheiben

Dimensions brake discs - Misure dischi freno -

Dimensions Disques de frein - Medidas disco de freno

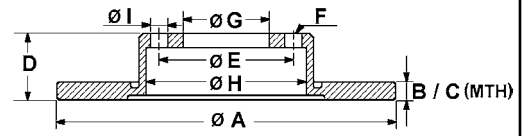

S Fixierschraube - fixing screw - vite di riparazione - vis de fixation - tornillo quefija
 B beschichtet - coated - rivestito - revêtu - recubierto
 HC hochgekohlt - high carbon - ad alto tenore di carbonio - à haute teneur en carbone - altamente carbonizado
 L legiert - alloyed - alligato/legato - allié - aleado
 V ventiliert - ventilated - ventilato - ventilé - ventilado
 ● gelocht - perforated - perforato - poinçonné - perforado

		S	B	HC	L	V	A	B	C	D	E	F	G	H	I	OE - #
24.0122-0140.1	422140						280,0	22,0	19,0	78,6	112,0	5	88,0	133,5	12,5	MERCEDES BENZ 601 420 03 72 601 421 05 12
24.0122-0141.1	422141					V	276,0	22,0	20,0	48,0	108,0	5	71,0	130,5	13,0	CITROEN PEUGEOT 4246 E8 4246 V0
24.0122-0142.1	422142	B	HC	L		V	283,0	22,0	20,0	28,2	108,0	4	66,1	133,5	13,0	CITROEN PEUGEOT 4246 V3 RENAULT 77 00 767 602 77 01 204 289
24.0122-0143.1	422143					V	280,0	22,0	20,0	58,0	108,0	5	61,0	131,5	14,7	ALFA/FIAT/LANCIA 46445006 60569163 60571548 60653478 60699518 71739567 71739568
24.0122-0145.1	422145	B				V	284,0	22,0	20,2	43,5	98,0	5	59,0	127,0	13,0	OPEL/VAUXHALL 5 69 086/95511282 NISSAN 40206-71E02 40206-71E05 40206-71E06 40206-93J01
24.0122-0146.1	422146	B				V	257,0	22,0	20,0	49,2	114,3	4	68,0	144,0	12,6	ALFA/FIAT/LANCIA 46403959 46448168 46455892 46455892 46758714 60810404 82450657
24.0122-0147.1	422147	B				V	284,0	22,0	20,2	43,5	98,0	4	59,0	127,0	13,0	CITROEN PEUGEOT 4249 76 4249 75
24.0122-0148.1	422148	S	B	HC	L	V	262,0	22,0	19,8	44,0	100,0	4	61,0	132,0	13,5	RENAULT 77 01 205 840
24.0122-0149.1	422149					V	262,0	22,0	19,8	44,0	108,0	5	61,0	132,0	15,5	RENAULT 77 01 205 841
24.0122-0150.1	422150	S	B	HC		V	280,0	22,0	19,0	36,7	100,0	5	65,0	133,5	15,6	AUDI/SEAT/SKODA/VW 1J0 615 301 E 1J0 615 301 M 1J0 615 301 P
24.0122-0151.1	422151	S	B	HC		V	256,0	22,0	19,0	36,7	100,0	5	65,0	133,5	15,6	AUDI/SEAT/SKODA/VW 1J0 615 301 D 1J0 615 301 L 6R0 615 301
24.0122-0152.1	422152	B	HC			V	280,0	22,0	20,0	46,3	112,0	5/9	68,0	146,5	15,3	AUDI/VW 8Z0 615 301 D 8E0 615 301 B 8E0 615 301 D 8E0 615 301 P
24.0122-0153.1	422153					V	238,0	22,0	21,0	47,9	100,0	4	54,0	127,0	14,5	TOYOTA 43512-20260
24.0122-0154.1	422154					V	255,0	22,0	21,0	47,9	100,0	5	54,0	131,0	14,5	TOYOTA 43512-32090 43512-32180
24.0122-0155.1	422155					V	258,0	22,0	20,4	33,5	104,0	5	84,0	153,5	10,8	MITSUBISHI MB407030
24.0122-0156.1	422156					V	257,0	22,0	20,6	36,0	109,0	6	88,0	152,5	M12x1,25	ISUZU 8-94172-376-1 OPEL/VAUXHALL 5 69 801/94172376
24.0122-0158.1	422158	B				V	255,0	22,0	20,0	48,1	100,0	4	55,0	131,1	14,5	TOYOTA 43512-12550
24.0122-0159.1	422159	S	B	HC		V	296,0	22,0	20,4	76,3	120,0	5	79,0	148,8	14,5	BMW 34 11 6 767 061
24.0122-0160.1	422160	S	B	HC		V	300,0	22,0	20,4	51,8	120,0	5	79,0	164,0	14,5	BMW 34 11 1 164 539 34 11 6 757 526 34 11 6 766 224 34 11 6 864 058 34 11 6 794 302
24.0122-0161.1	422161	S	B	HC	L	V	276,0	22,0	19,0	77,2	130,0	5	85,0	156,3	15,0	MERCEDES BENZ 902 421 06 12 902 421 07 12 902 421 09 12 VOLKSWAGEN 2D0 615 301 C 2D0 615 301 D
24.0122-0162.1	422162	S	B	HC	L	V	276,0	22,0	19,0	60,0	112,0	5	67,0	153,0	15,0	MERCEDES BENZ 638 421 01 12
24.0122-0163.1	422163	B	HC			V	256,0	22,0	20,0	36,6	100,0	5	65,0	135,0	15,6	AUDI/SEAT/SKODA/VW 8N0 615 601 B
24.0122-0164.1	422164					V	256,0	22,0	20,0	40,0	100,0	4/6	61,0	149,5	13,0	VOLVO 3455719
24.0122-0165.1	422165					V	257,0	22,0	20,0	45,0	100,0	4	55,0	125,0	13,0	MAZDA BB7E-33-25XD BR74-33-25X
24.0122-0166.1	422166	B				V	235,0	22,0	20,0	45,0	100,0	4	55,0	125,0	13,0	MAZDA BR70-33-25XF
24.0122-0167.1	422167					V	250,0	22,0	20,0	30,0	95,0	4	73,0	140,0	10,8	NISSAN 40206-04C01 40206-Y9503
24.0122-0168.1	422168	S	B	HC	L	V	260,0	22,0	19,4	40,4	112,0	5	67,0	145,0	13,3	MERCEDES BENZ 168 421 02 12 168 421 08 12
24.0122-0169.1	422169					V	257,0	22,0	20,0	44,0	114,3	4	69,0	160,0	12,6	HYUNDAI 51712-33001
24.0122-0170.1	422170					V	257,0	22,0	20,0	34,0	104,0	4	86,0	160,5	10,6	HYUNDAI 51712-28300



Abmessungen Bremsscheiben

Dimensions brake discs - Misure dischi freno -

Dimensions Disques de frein - Medidas disco de freno

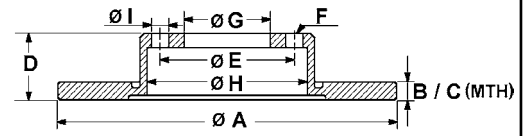

S Fixierschraube - fixing screw - vite di riparazione - vis de fixation - tornillo quefija

B beschichtet - coated - rivestito - revêtu - recubierto

HC hochgekohlt - high carbon - ad alto tenore di carbonio - à haute teneur en carbone - altamente carbonizado

L legiert - alloyed - alligato/legato - allié - aleado

V ventiliert - ventilated - ventilato - ventilé - ventilado

● gelocht - perforated - perforato - poinçonné - perforado

		S	B	HC	L	V	A	B	C	D	E	F	G	H	I	OE	#
24.0122-0172.1	422172		B			V	258,0	22,0	20,0	43,4	108,0	4	63,5	136,0	13,7	FORD	1808479
																MAZDA	98AX-1125-B1F DD32-33-25X DD59-33-25X DD63-33-25XA
24.0122-0174.1	422174					V	280,0	22,0	20,0	49,0	114,3	5	68,0	160,5	12,6	NISSAN	40206-2L903 40206-88E01 40206-88E04
24.0122-0175.1	422175					V	277,0	22,0	20,4	45,0	108,0	6	87,0	87,5	11,0	HYUNDAI MITSUBISHI	MN116706 MB407038 MB407039 MN116706
24.0122-0177.1	422177					V	240,5	22,0	20,0	43,0	95,2	4	66,0	122,0	13,0	MG/ROVER	NAM7806
24.0122-0178.1	422178					V	255,0	22,0	20,0	46,5	100,0	5	54,0	148,5	14,5	TOYOTA	43512-20360 43512-20380
24.0122-0179.1	422179		B			V	280,0	22,0	20,0	49,2	114,3	4	68,0	143,5	12,5	NISSAN	40206-2F501 40206-55F01 40206-55F03
24.0122-0180.1	422180					V	267,0	22,0	20,0	39,5	124,0	6	100,0	167,0	M10x1,25	NISSAN	40206-10W00 40206-10W01 40206-35G00 40206-35G01
24.0122-0181.1	422181					V	280,0	22,2	20,7	77,0	114,0	5	72,0	147,5	15,5	JEEP	83 03 251 156 98 83 251 156 J325 1156
24.0122-0183.1	422183					V	279,0	22,0	20,0	52,5	114,3	5	62,0	147,0	14,6	TOYOTA	43512-28080
24.0122-0185.1	422185					V	319,0	22,0	20,0	70,2	139,7	6	108,0	173,0	14,6	TOYOTA	43512-35210
24.0122-0188.1	422188					V	258,0	22,0	21,0	48,0	100,0	4	54,0	131,0	14,6	TOYOTA	43512-12490
24.0122-0191.1	422191					V	281,0	22,0	20,2	47,5	108,0	5/10	59,0	134,0	14,7	LANCIA	46449389 82487489
24.0122-0192.1	422192		B	HC	L	V	300,0	22,0	19,4	58,5	112,0	5	67,0	180,0	15,0	MERCEDES BENZ	220 423 02 12
24.0122-0193.1	422193					V	250,0	22,0	20,0	50,2	114,3	5	68,0	140,0	12,7	NISSAN	40206-9C001
24.0122-0194.1	422194		S	B		V	266,0	22,0	20,0	34,2	108,0	4	66,0	133,1	13,0	CITROEN	4246 W1 4249 83 4249 G1 4246 W7 4249 83 4249 G1
24.0122-0196.1	422196		B	HC	L	V	285,0	21,9	19,0	93,0	145,0	6	120,0	169,0	15,0	MERCEDES BENZ VOLKSWAGEN	904 423 03 12 2D0 615 601 B
24.0122-0197.1	422197		B			V	257,5	22,0	20,2	40,5	98,0	4	59,0	127,0	13,0	CITROEN	4249 74 4249 L2 46401356 46542383 46831041 51896287 51896288 4249 73 4249 L2
																FIAT/LANCIA	46401356 46542383 46831041 51896287 51896288 4249 73 4249 L2
24.0122-0198.1	422198		B	HC		V	269,0	21,9	20,0	46,4	112,0	5	68,0	135,0	15,3	AUDI	4D0 615 601 B
24.0122-0199.1	422199		B	HC	L	V	270,0	22,0	19,4	35,5	112,0	5	67,0	145,0	13,3	MERCEDES BENZ	414 421 00 12
24.0122-0200.1	422200					V	310,0	22,0	20,0	29,0	140,0	5	108,3	181,2	13,0	SUZUKI	55211-65D12
24.0122-0201.1	422201		S	B		V	300,0	22,0	19,4	68,0	112,0	5	67,0	180,0	15,3	MERCEDES BENZ	000 423 09 12
24.0122-0202.1	422202		B	HC		V	280,0	22,0	20,0	42,4	112,0	5	68,0	158,5	15,3	AUDI/VW	4E0 615 601 4E0 615 601 E 4E0 615 601 J
24.0122-0203.1	422203		B	HC		V	269,0	22,0	20,0	47,9	112,0	5/10	68,0	135,0	15,3	AUDI	4Z7 615 601
24.0122-0204.1	422204		B	HC		V	276,0	22,0	20,4	44,2	100,0	4	64,2	150,0	14,7	MINI	34 11 6 774 984
24.0122-0206.1	422206		B			V	284,0	22,0	19,0	38,2	100,0	5	64,2	142,0	15,3	ROVER	GBD90844 SDB000880 SDB100940
24.0122-0207.1	422207		B			V	235,0	22,0	20,0	46,0	100,0	4	55,0	125,0	13,0	MAZDA	B26Y-33-25XA
24.0122-0208.1	422208		B	HC	L	V	276,0	22,0	19,4	35,5	112,0	5	67,0	145,0	13,3	MERCEDES BENZ	168 421 06 12
24.0122-0209.1	422209		S	B	HC	V	320,0	22,0	20,4	60,5	120,0	5	75,0	185,0	14,5	BMW	34 20 1 166 073
24.0122-0210.1	422210		S	B	HC	V	280,0	22,0	19,0	49,9	112,0	5/9	65,0	144,0	15,3	AUDI/SEAT/SKODA/VW VOLKSWAGEN	1K0 615 301 AK 5C0 615 301 JZW 615 301 A
24.0122-0211.1	422211		B	HC		V	294,0	21,9	19,5	44,4	120,0	5	76,0	154,6	16,6	VOLKSWAGEN	7H0 615 601 B
24.0122-0212.1	422212		B	HC		V	310,0	22,0	20,0	42,4	112,0	5	68,0	178,0	15,3	AUDI VOLKSWAGEN	4E0 615 601 K 3D0 615 601 D
24.0122-0213.1	422213		B	HC	L	V	315,0	22,0	19,4	59,3	112,0	5	67,0	180,0	15,0	MERCEDES BENZ	220 423 03 12
24.0122-0214.1	422214		B	HC		V	335,0	22,0	20,0	42,4	112,0	5	68,0	191,5	15,3	AUDI/VW VOLKSWAGEN	4E0 615 601 L 3D0 615 601 C
24.0122-0215.1	422215		B	HC		V	314,0	22,0	18,0	75,5	120,0	5	76,0	185,0	16,6	VOLKSWAGEN	7L6 615 601 G

Abmessungen Bremsscheiben

Dimensions brake discs - Misure dischi freno -

Dimensions Disques de frein - Medidas disco de freno

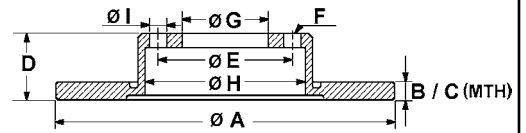

S Fixierschraube - fixing screw - vite di riparazione - vis de fixation - tornillo quefija
B beschichtet - coated - rivestito - revêtu - recubierto
HC hochgekohlt - high carbon - ad alto tenore di carbonio - à haute teneur en carbone - altamente carbonizado
L legiert - alloyed - alligato/legato - allié - aleado
V ventiliert - ventilated - ventilato - ventilé - ventilado
● gelocht - perforated - perforato - poinçonné - perforado

		S	B	HC	L	V	A	B	C	D	E	F	G	H	I	OE - #
24.0122-0216.1	422216	S	B	HC		V	260,0	22,0	19,8	44,0	100,0	4	61,0	125,0	13,6	NISSAN 40206-AX600 RENAULT 40206-AX603 VOLVO 77 01 207 795
24.0122-0217.2	422217					V	262,5	22,0	20,0	72,0	108,0	5	46,0	60,0	M12x1,5	270876
24.0122-0218.1	422218		B	HC	L	V	300,0	22,0	19,4	57,5	112,0	5	67,0	164,0	15,0	MERCEDES BENZ 129 423 03 12
24.0122-0219.1	422219		B	HC		V	310,0	22,0	20,0	48,5	112,0	5/9	65,0	169,0	15,3	AUDI/SEAT/SKODA/VW 1K0 615 601 N
24.0122-0220.1	422220		B	HC		V	300,0	22,0	20,0	36,2	112,0	5/9	68,0	172,0	15,3	AUDI 8E0 615 601 R
24.0122-0221.1	422221		B	HC		V	256,0	22,0	20,0	48,1	112,0	5	68,0	135,0	15,3	AUDI/VW 8D0 615 601 D
24.0122-0222.1	422222		B	HC		V	269,0	22,0	20,0	54,1	112,0	5	68,0	135,0	15,4	AUDI/VW 4B3 615 601
24.0122-0223.1	422223		B	HC		V	330,0	22,0	20,0	49,4	112,0	5	68,0	138,0	15,3	AUDI 4F0 615 601 F
24.0122-0224.1	422224	S	B	HC		V	320,0	22,0	20,4	79,7	120,0	5	75,0	185,0	16,5	BMW 34 21 3 332 217
24.0122-0225.1	422225					V	284,0	22,0	20,2	39,4	98,0	5	59,0	127,0	13,0	ALFA ROMEO 60606170
24.0122-0226.1	422226	S	B	HC	L	V	330,0	22,0	19,4	63,0	112,0	5	67,0	210,0	15,2	MERCEDES BENZ 164 423 13 12
24.0122-0227.1	422227					V	235,0	22,0	20,0	45,0	100,0	4	55,0	124,5	13,0	KIA MDX74-33-251
24.0122-0228.1	422228		B	HC	L	V	300,0	22,0	19,4	55,3	112,0	5	67,0	164,0	13,2	CHRYSLER 5135 505AA
24.0122-0229.1	422229		B	HC	L	V	300,0	22,0	19,4	58,3	112,0	5	67,0	180,0	15,2	MERCEDES BENZ 230 423 04 12
24.0122-0230.1	422230		B			V	285,0	22,0	20,4	38,5	114,3	5	69,0	145,0	12,5	MERCEDES BENZ MR334996
24.0122-0231.1	422231	S	B			V	257,0	22,0	20,0	40,5	100,0	4/6	60,0	126,0	14,5	FIAT 55700920 55700921
24.0122-0232.1	422232	S	B	HC	L	V	276,0	22,0	19,4	44,5	112,0	5	67,0	145,0	15,3	OPEL/VAUXHALL 5 69 024/93188917
24.0122-0233.1	422233	S	B			V	292,0	22,0	20,0	43,2	110,0	5	70,0	139,0	16,6	5 69 065/9319724 MERCEDES BENZ 169 421 08 12
24.0122-0234.1	422234					V	281,0	22,0	20,2	47,5	108,0	5	59,0	133,8	14,7	ALFA ROMEO 51760274 51767380
24.0122-0235.1	422235					V	270,0	22,0	20,0	46,0	100,0	4	55,0	125,0	13,0	LANCIA 46469907
24.0122-0236.1	422236	S	B	HC		V	336,0	22,0	20,4	67,3	120,0	5	75,0	185,0	14,5	MAZDA N0YY-33-25X
24.0122-0237.1	422237		B			V	277,0	22,0	20,4	45,5	108,0	6	87,0	170,0	10,5	BMW 34 21 6 855 004
24.0122-0238.1	422238	S	B	HC		V	292,0	22,0	20,4	73,3	120,0	5	79,0	151,5	14,5	HYUNDAI HQ232405
24.0122-0239.1	422239	S	B	HC		V	284,0	22,0	20,4	73,3	120,0	5	79,0	151,5	16,6	MITSUBISHI HQ232405
24.0122-0240.1	422240		B			V	258,0	22,0	20,0	46,0	100,0	4	55,0	131,0	14,3	BMW 34 11 6 854 997
24.0122-0241.1	422241	S	B			V	284,0	22,0	20,0	43,5	100,0	4/6	60,0	127,0	14,2	BMW 34 11 6 792 215 34 11 6 854 996
24.0122-0242.1	422242	S	B	HC		V	310,0	22,0	20,0	58,6	112,0	5	65,0	140,0	15,3	DAIHATSU 43512-0D060
24.0122-0243.1	422243		B	HC		V	330,0	22,0	20,0	42,5	112,0	5	68,0	146,0	15,3	TOYOTA 43512-0D060
24.0122-0244.1	422244		B	HC		V	294,0	22,0	20,4	44,2	100,0	4	64,2	150,0	14,7	FIAT 55700922
24.0122-0245.1	422245		B	HC	L	V	285,0	22,0	19,0	72,0	130,0	5	85,0	156,3	15,0	OPEL/VAUXHALL 55 69 025/93188918
24.0122-0246.1	422246		B			V	255,0	22,0	19,0	46,3	100,0	4	55,0	131,0	14,5	AUDI 8J0 615 601 A
24.0122-0247.1	422247		B	HC		V	294,0	22,0	20,4	44,2	100,0	4	64,2	150,0	16,2	AUDI 4F0 615 601 B
24.0122-0248.1	422248		B	HC		V	280,0	22,0	20,4	44,2	100,0	4	64,2	150,0	16,2	MINI 34 11 6 768 933
24.0122-0249.1	422249		B			V	290,0	22,0	20,0	45,0	114,3	5	72,0	142,8	13,0	MERCEDES BENZ 903 421 01 12
24.0122-0250.1	422250	S	B	HC		V	330,0	22,0	20,0	36,4	112,0	5	68,0	154,0	15,3	TOYOTA 43512-52120
24.0122-0252.1	422252		B			V	280,0	22,0	20,0	47,0	114,3	5	62,0	146,3	12,7	TOYOTA 43512-52120
24.0122-0253.1	422253					V	297,0	22,0	20,0	70,2	139,7	6	108,0	170,0	14,5	MINI 34 11 6 774 986 34 11 6 858 652 34 11 6 774 985 34 11 6 858 651
24.0122-0254.1	422254		B			V	275,0	22,0	19,0	46,5	100,0	4	55,0	131,0	14,5	MAZDA NF4Y-33-25X N12Y-33-25X
24.0122-0255.1	422255					V	302,0	22,0	20,0	35,0	108,0	5	71,1	132,7	13,0	AUDI 8K0 615 601 C
24.0122-0256.1	422256		B			V	275,0	22,0	19,0	46,3	114,3	5	62,0	145,0	14,8	FIAT 71768306
24.0122-0257.1	422257	S	B	HC		V	324,0	22,0	20,4	77,3	120,0	5	75,0	185,0	14,5	SUZUKI 55311-79J01 55311-79J02 55311-80J02
24.0122-0258.1	422258		B	HC		V	255,0	22,0	20,0	49,3	100,0	5	55,0	131,0	14,5	TOYOTA 43512-35280
24.0122-0259.1	422259		B	HC		V	302,0	22,0	20,0	40,8	108,0	5	63,5	165,0	15,8	TOYOTA 43512-35310
24.0122-0260.1	422260		B			V	256,0	22,0	20,0	46,6	100,0	4	62,2	126,0	12,5	CITROEN 96 879 907 80
24.0122-0261.1	422261		B	HC		V	302,0	22,0	20,0	50,7	108,0	5	63,5	165,0	15,7	TOYOTA 43512-12670
24.0122-0262.1	422262					V	276,0	22,0	19,0	72,5	118,0	5	73,0	145,0	15,5	BMW 34 21 6 778 649
24.0122-0263.1	422263		B			V	254,0	22,0	20,0	42,0	100,0	4	55,0	137,0	13,0	TOYOTA 43512-47030
24.0122-0264.1	422264		B			V	290,0	22,0	19,0	78,0	127,0	8	110,0	172,0	10,7	VOLVO 31341483
24.0122-0266.1	422266		B	HC	L	V	290,0	22,0	19,0	42,5	120,0	10	102,0	144,3	10,5	HYUNDAI 51712-1G000
24.0122-0267.1	422267		B	HC	L	V	290,0	22,0	19,0	78,0	132,0	8	115,0	172,0	10,8	KIA 51712-1W250
																VOLVO 31277357
																IVECO 42470836
																DAIHATSU 43512-B1030-000
																SUBARU 43512B1030
																NISSAN 43206-MA50A 43207-9X100
																RENAULT 50 10 260 604
																RENAULT 50 10 260 609

Abmessungen Bremsscheiben

Dimensions brake discs - Misure dischi freno -

Dimensions Disques de frein - Medidas disco de freno

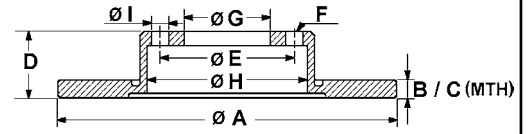

S Fixierschraube - fixing screw - vite di riparazione - vis de fixation - tornillo quefija

B beschichtet - coated - rivestito - revêtu - recubierto

HC hochgekohlt - high carbon - ad alto tenore di carbonio - à haute teneur en carbone - altamente carbonizado

L legiert - alloyed - alligato/legato - allié - aleado

V ventiliert - ventilated - ventilato - ventilé - ventilado

● gelocht - perforated - perforato - poinçonné - perforado

		S	B	HC	L	V	A	B	C	D	E	F	G	H	I	OE - #	
24.0122-0268.1	422268		B			V	322,0	22,0	20,2	62,0	114,3	5	68,0	172,0	12,7	NISSAN	43206-CD005
24.0122-0270.1	422270	S	B	HC		V	258,0	22,0	19,8	44,0	100,0	4	61,0	125,3	13,5	MERCEDES BENZ DACIA	415 420 01 01 40 20 612 00R 40 20 670 16R
																RENAULT	77 01 210 081 40 20 612 00R 40 20 675 01R
24.0122-0271.1	422271	S	B	HC		V	294,0	22,0	20,4	45,2	120,0	5	79,0	152,0	16,5	MINI	34 11 9 804 828 34 11 9 811 537
24.0122-0272.1	422272	S	B	HC		V	330,0	21,9	20,0	36,0	112,0	5	68,0	147,7	15,3	AUDI	4H0 615 601 D 4H0 615 601 H 4H0 615 601 K 95B 615 601 A
24.0122-0273.1	422273	S	B	HC		V	356,0	22,0	20,0	36,2	112,0	5	68,0	159,8	15,3	PORSCHE	4H0 615 601 F
24.0122-0276.1	422276		B			V	275,0	22,0	19,0	46,3	100,0	5	55,0	131,0	14,5	SUBARU	4351212710
24.0122-0277.1	422277		B			V	260,0	22,0	20,0	44,0	100,0	4	61,0	130,0	12,8	TOYOTA	43512-12710
24.0122-0278.1	422278	S	B	HC		V	300,0	22,0	20,4	73,0	120,0	5	79,0	152,0	16,5	NISSAN	40206-1HA0A
24.0122-0280.1	422280		B			V	256,0	22,0	20,0	40,2	100,0	4	60,0	132,8	12,5	BMW	34 11 6 792 217
24.0122-0281.1	422281	S	B	HC		V	256,0	22,0	19,0	36,7	100,0	4	65,0	132,0	13,8	SUZUKI	55311-68L00
24.0122-0282.1	422282		B			V	272,0	22,0	20,0	40,2	100,0	4	60,0	150,0	12,5	SEAT/SKODA/VW	1S0 615 301
24.0122-0283.1	422283		B			V●	284,0	22,0	20,2	43,5	98,0	4	59,0	127,0	13,2	SUZUKI	55311-68L50
24.0122-0286.1	422286		B			V	284,0	22,0	20,0	43,5	98,0	5	59,0	127,0	13,5	FIAT	5741446 51937217 51937218
24.0122-0289.1	422289	S	B	HC	L	V	258,0	22,0	19,8	43,9	100,0	4	61,0	126,5	13,5	DACIA RENAULT	40 20 631 49R 40 20 622 12R 40 20 676 15R 453 420 01 00
24.0122-0290.1	422290		B			V	280,0	22,0	20,0	47,0	114,3	5	62,0	146,3	12,7	SMART	55311-61M00
24.0122-0724.1	422724		B			V	300,0	22,0	20,4	72,3	139,7	6	94,0	199,0	12,6	SUZUKI	MR418067
24.0123-0100.1	423100					V	246,0	23,0	21,0	55,5	92,0	4	73,0	115,0	10,6	MITSUBISHI	5 69 036/90009433
24.0123-0101.1	423101					V	280,0	23,4	21,5	43,5	108,0	4	68,0	152,8	15,0	OPEL/VAUXHALL	4002150 8965550
24.0123-0102.1	423102					V	282,0	23,0	21,0	34,0	114,3	4	92,0	160,0	M10x1,25	SAAB	45251-SM4-G02 GBD90837
24.0123-0103.1	423103					V	260,0	23,0	21,0	34,0	114,3	4	92,0	160,0	M10x1,25	HONDA	45251-SM4-020 GBD90836
24.0123-0104.1	423104	S	B			V	282,0	23,0	21,0	47,1	114,3	5	70,2	148,5	12,6	ROVER	45251-S2H-N00 45251-SP0-000 45251-SZ3-000 45251-SZ3-E00
24.0123-0105.1	423105					V	260,0	23,0	21,0	47,2	114,3	4	64,1	141,0	12,8	HONDA	45251-S1A-G60 45251-SS0-000
24.0123-0106.1	423106					V	282,0	23,0	21,0	47,2	114,3	4	64,1	141,0	13,0	HONDA	45251-SS0-A00 45251-ST3-E60
24.0123-0108.1	423108					V	295,0	22,5	21,0	66,5	120,7	5	80,0	154,3	13,4	JAGUAR	JLM 1305
24.0123-0109.1	423109	S	B			V	282,0	23,0	21,0	47,1	114,3	5	64,1	141,0	12,5	HONDA	45251-S7A-N10 45251-SCA-E00
24.0123-0110.1	423110	S	B			V	282,0	23,0	21,0	47,2	114,3	5	64,2	141,0	12,6	HONDA	45251-S7A-E10 45251-SMG-G10 45251-SMG-E31
24.0123-0111.1	423111	S	B			V	260,0	23,0	21,0	44,5	100,0	4	64,1	141,5	13,0	HONDA	45251-S6F-E10
24.0123-0112.1	423112		B	HC		V	258,0	23,0	21,0	43,9	100,0	4	55,0	135,8	13,0	MAZDA	DF71-33-251
24.0123-0113.1	423113		B	HC		V	258,0	23,0	21,0	43,8	108,0	4	63,5	136,0	13,0	FORD	1523795 1535924 1546835 1679853 8V51-1125-AC 8V51-1125-AD
24.0123-0114.1	423114	S	B			V	315,0	22,9	21,5	48,0	120,0	5	67,4	172,0	16,3	CHEVROLET OPEL/VAUXHALL	13501314 5 69 062/13501303 5 69 128/13502199 13502199
24.0123-0116.1	423116	S	B			V	315,0	23,0	20,0	45,0	115,0	5	70,7	172,0	14,2	OPEL	5 69 093/13586855
24.0123-0119.1	423119	S	B	HC		V	269,0	22,5	19,8	44,1	114,3	5	68,0	141,0	15,7	DACIA/RENAULT	40 20 663 00R
24.0123-0122.1	423122		B			V	278,0	23,0	21,0	43,9	108,0	4	63,5	136,0	13,0	FORD	1751584 AY11-1125-AA 1833857 EY16-1125-AA
24.0123-0123.1	423123		B	HC		V	280,0	23,1	21,0	44,4	114,3	5	69,0	143,4	12,7	HYUNDAI/KIA	51712-A6000
24.0124-0103.1	424103		B			V	252,5	24,0	22,0	53,5	95,0	6	76,0	105,0	M10x1,5	OPEL/VAUXHALL RENAULT	44 03 283/9111283 77 01 204 281



Abmessungen Bremsscheiben

Dimensions brake discs - Misure dischi freno -

Dimensions Disques de frein - Medidas disco de freno

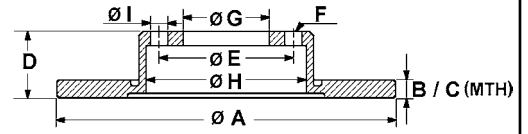

S Fixierschraube - fixing screw - vite di riparazione - vis de fixation - tornillo quefija

B beschichtet - coated - rivestito - revêtu - recubierto

HC hochgekohlt - high carbon - ad alto tenore di carbonio - à haute teneur en carbone - altamente carbonizado

L legiert - alloyed - alligato/legato - allié - aleado

V ventiliert - ventilated - ventilato - ventilé - ventilado

● gelocht - perforated - perforato - poinçonné - perforado

		S	B	HC	L	V	A	B	C	D	E	F	G	H	I	OE - #	
24.0124-0105.1	424105					V	264,0	24,0	22,0	46,5	114,3	5	64,0	137,0	12,6	FORD MAZDA	E92Z 1125A GJ25-33-25XD GJ55-33-25XC
24.0124-0107.1	424107					V	270,0	24,0	22,6	71,2	100,0	5	78,6	138,5	M10	FORD	5022675
24.0124-0109.1	424109					V	260,0	24,2	22,2	51,6	112,0	5	72,0	137,0	13,7	FORD	6158214
24.0124-0110.1	424110					V	280,0	24,0	21,0	58,4	110,0	5	70,0	139,0	14,0	OPEL/VAUXHALL	5 69 038/90271133
24.0124-0111.1	424111		B			V	258,0	24,0	21,0	58,4	110,0	5	70,0	139,0	14,0	OPEL/VAUXHALL	5 69 039/90271134
24.0124-0112.1	424112		B			V	239,5	24,2	22,2	58,1	108,0	4	63,5	136,0	13,7	FORD	5022659 5022660 5022948 5023573
24.0124-0113.1	424113					V	260,0	24,2	22,2	58,1	108,0	4	63,5	136,0	13,7	FORD	1102560 5022663
24.0124-0114.1	424114					V	266,0	24,0	22,4	45,2	114,3	4	69,0	144,0	12,6	MITSUBISHI	MB366080 MB500968 MB500969
24.0124-0115.1	424115	S	B	HC	L	V	256,0	24,0	21,0	41,0	100,0	4/6	60,0	123,0	14,0	DAEWOO OPEL/VAUXHALL	96179110 5 69 001/90487402
24.0124-0116.1	424116			HC	L	V	299,0	24,0	22,0	71,0	130,0	5	103,0	180,0	15,4	PORSCHE	951 352 041 01
24.0124-0117.1	424117			HC	L	V	299,0	24,0	22,0	100,0	130,0	5	103,0	180,0	15,4	PORSCHE	951 352 041 02
24.0124-0118.1	424118		B	HC	L	V	280,0	24,0	20,0	64,5	112,0	5	68,2	144,0	16,5	VOLKSWAGEN	701 615 301 D
24.0124-0119.1	424119		B	HC	L	V	286,0	24,0	21,0	58,4	110,0	5	70,0	139,0	14,0	OPEL/VAUXHALL	5 69 053/90487103
24.0124-0120.1	424120		B			V	260,0	24,0	22,2	47,0	108,0	4	63,5	136,0	13,6	FORD	4070865 5026784
24.0124-0121.1	424121					V	260,0	24,2	22,2	53,1	112,0	5	63,5	138,0	13,7	FORD	5027462 5027463
24.0124-0125.1	424125					V	260,0	24,2	22,2	44,0	108,0	4	63,5	136,0	13,7	FORD	5025950
24.0124-0127.1	424127		B			V	280,0	24,0	21,9	67,6	118,0	5	73,0	142,0	15,5	CITROEN	4246 Y1 4249 99 4249 K3 4249 H8 16 078 720 80
24.0124-0128.1	424128	S	B	HC		V	280,0	24,0	20,0	55,2	112,0	5	68,2	144,0	16,5	VOLKSWAGEN	7D0 615 301 C
24.0124-0129.1	424129		B			V	258,0	24,0	22,0	48,6	114,3	5	72,0	142,5	13,0	FORD MAZDA	3958455 GA2Y-33-25X GA4Y-33-25X GA4Y-33-25XC GA4Y-33-25XD GA4Y-33-25XJ GA5Y-33-25X GA5Y-33-25XD
24.0124-0131.1	424131		B			V	254,0	24,2	22,2	43,0	100,0	5	78,5	104,0	M10	FORD	5025610 5029815
24.0124-0132.1	424132		B			V	270,0	24,2	22,2	43,0	100,0	5	78,5	104,0	M10	FORD	5029816
24.0124-0133.1	424133			HC	L	V	284,0	24,0	21,0	41,0	110,0	5/8	70,0	145,0	14,0	OPEL/VAUXHALL SAAB	5 69 047/90442513 4241428
24.0124-0136.1	424136		B			V	256,0	24,0	21,5	45,5	114,3	4	69,0	145,0	12,6	HYUNDAI/KIA MITSUBISHI	51712-M2000 MB407639 MB928995 MR128153 MR205584 MR205585
24.0124-0137.1	424137					V	278,0	24,0	22,0	70,0	120,0	6	95,0	136,0	M12x1	VOLVO RENAULT	30872926 50 00 388 057
24.0124-0138.1	424138		B			V	300,0	24,0	21,9	65,5	130,0	5	80,0	161,0	17,5	CITROEN	4249 H2 4249 H9 16 078 722 80
																FIAT	46806234 51728378 51740247
																PEUGEOT	51858363 4246 Y5 4249 H2 4249 H9 16 078 722 80

Abmessungen Bremsscheiben

Dimensions brake discs - Misure dischi freno -

Dimensions Disques de frein - Medidas disco de freno

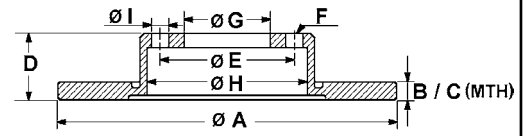

S Fixierschraube - fixing screw - vite di riparazione - vis de fixation - tornillo quefija

B beschichtet - coated - rivestito - revêtu - recubierto

HC hochgekohlt - high carbon - ad alto tenore di carbonio - à haute teneur en carbone - altamente carbonizado

L legiert - alloyed - alligato/legato - allié - aleado

V ventiliert - ventilated - ventilato - ventilé - ventilado

● gelocht - perforated - perforato - poinçonné - perforado

		S	B	HC	L	V	A	B	C	D	E	F	G	H	I	OE	#
24.0124-0139.1	424139	S	B			V	260,0	24,0	22,0	28,0	108,0	4	66,0	133,5	13,0	PEUGEOT	4246 L9
24.0124-0140.1	424140	B				V	276,0	24,0	22,4	45,1	108,0	6	87,0	136,0	10,6	MITSUBISHI	MB618716 MB928120 MB928697 MR129648 MR129649
24.0124-0141.1	424141	B				V	260,0	24,0	22,0	56,8	100,0	5	58,0	129,0	12,8	SUBARU	26300AE091 26310AA021 26310AA031 26310AA032 26310AC060
24.0124-0142.1	424142					V	256,0	24,0	22,4	45,3	114,3	5	69,0	145,0	12,6	MITSUBISHI	MB618799 MB668108
24.0124-0143.1	424143	B				V	298,5	24,0	22,0	70,0	127,0	5	101,6	158,0	10,0	LAND ROVER	FTC902
24.0124-0144.1	424144					V	276,0	24,0	22,4	45,2	114,3	5	69,0	165,0	12,6	MITSUBISHI	MB618344 MB858799
24.0124-0145.1	424145	B				V	277,0	24,0	22,0	56,5	100,0	5	58,0	129,0	13,0	SUBARU	26300AE050 26300AE070 26300AE071 26310AA091 26310AA092 26310AA120 26310AA121
24.0124-0146.1	424146	B				V	256,0	24,0	22,4	45,3	114,3	4	69,0	145,0	12,6	HYUNDAI/KIA MITSUBISHI	51712-M2010 MB668886 MB950570
24.0124-0147.1	424147					V	256,0	24,0	22,4	45,3	114,3	5	69,0	145,0	12,6	MITSUBISHI	MB699761
24.0124-0148.1	424148					V	278,0	24,0	22,2	35,5	108,0	4	63,5	137,0	13,7	FORD	5024174 5026674
24.0124-0149.1	424149	B				V	278,0	24,1	22,2	46,9	108,0	4	63,5	136,0	13,6	FORD	4070864 5026785
24.0124-0151.1	424151					V	260,0	24,3	22,8	53,0	108,0	4	63,5	137,0	13,8	FORD	5022664
24.0124-0152.1	424152	S	B	HC	L	V	256,0	23,8	21,0	41,1	100,0	4	60,0	123,0	14,3	OPEL/VAUXHALL	5 69 059/9117677
24.0124-0158.1	424158	S	B	HC	L	V	280,0	24,0	21,8	44,0	100,0	4	61,0	140,0	13,6	RENAULT	77 01 207 829 86 71 005 975
24.0124-0159.1	424159	B				V	281,0	23,9	21,5	45,7	114,3	4	69,0	146,5	12,5	MITSUBISHI VOLVO	M818027 30818027
24.0124-0161.1	424161	B				V	300,0	23,9	22,0	47,0	108,0	5	63,5	155,0	13,7	FORD	1376118 4179398 4181042
24.0124-0162.1	424162	B				V	280,0	24,0	21,0	61,5	110,0	6	79,5	119,0	M10x1,5	OPEL/VAUXHALL RENAULT	C2S 35270 C2S 42667 C2S 52091 45 00 098/9160398 77 00 302 128 86 71 017 103
24.0124-0163.1	424163	S				V	256,0	24,0	22,0	47,1	100,0	4/6	60,0	134,0	13,2	CHEVROLET	96286933 96312559
24.0124-0164.1	424164	B				V	258,0	24,0	22,0	47,0	100,0	4	55,0	125,0	13,0	MAZDA	96286933 96312559
24.0124-0165.1	424165	B	HC	L		V	298,0	24,0	22,0	67,0	130,0	5	98,0	164,0	15,4	PORSCHE	BJ1Y-33-25X 986 351 401 05
24.0124-0166.1	424166	B	HC	L		V	260,0	24,0	21,0	41,0	100,0	4/6	60,0	126,0	14,5	OPEL/VAUXHALL	5 69 000/9196050
24.0124-0167.1	424167	B				V	276,0	24,5	22,1	43,0	100,0	5	82,0	136,0	M10	FORD	1738807 1C1J-1125-A2D
24.0124-0168.1	424168	B				V	294,0	24,5	22,1	43,0	100,0	5	82,0	136,0	M10	FORD	1738815 YC1J-1125-B2B
24.0124-0169.1	424169	B	HC			V	280,0	24,0	21,8	46,9	108,0	5	61,0	139,8	13,5	RENAULT	82 00 007 121 86 71 017 410
24.0124-0170.1	424170	B				V	276,0	24,0	22,4	45,0	114,3	4	69,0	145,0	12,5	MITSUBISHI	MR389725 MR475331
24.0124-0171.1	424171	S	B	HC	L	V	280,0	24,0	21,8	44,0	108,0	5	61,0	140,0	15,5	RENAULT	77 01 206 198
24.0124-0172.1	424172					V	284,5	24,0	22,4	51,0	139,6	5	96,3	171,0	12,5	KIA	0K011-33-251D 0K01A-33-251C 0K01A-33-25XB
24.0124-0173.1	424173					V	258,0	24,0	22,0	48,6	114,3	4	72,0	143,7	13,0	KIA	0K9AA-33-251 0K9AA-33-251B 0K9AA-33-251C
24.0124-0174.1	424174					V	284,0	24,2	22,9	60,5	111,1	5	82,6	138,5	11,5	JAGUAR	JLM 727 JLM 776
24.0124-0175.1	424175	B				V	273,5	24,0	22,0	47,5	114,3	5	72,0	143,0	13,0	MAZDA	GF3Y-33-25XA
24.0124-0176.1	424176	B	HC	L	●	V	299,0	24,0	22,0	75,0	130,0	5	98,0	180,0	15,4	PORSCHE	996 352 401 05
24.0124-0177.1	424177	B	HC			V	345,0	24,0	22,4	67,0	120,0	5	79,0	185,0	16,5	BMW	34 21 1 166 129
24.0124-0178.1	424178	B				V	282,5	24,0	22,4	38,0	114,3	5	73,5	159,3	14,0	CHRYSLER	4721 820AE

Abmessungen Bremsscheiben

Dimensions brake discs - Misure dischi freno -

Dimensions Disques de frein - Medidas disco de freno

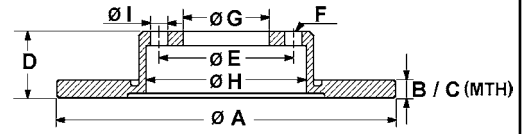

S Fixierschraube - fixing screw - vite di riparazione - vis de fixation - tornillo quefija

B beschichtet - coated - rivestito - revêtu - recubierto

HC hochgekohlt - high carbon - ad alto tenore di carbonio - à haute teneur en carbone - altamente carbonizado

L legiert - alloyed - alligato/legato - allié - aleado

V ventiliert - ventilated - ventilato - ventilé - ventilado

● gelocht - perforated - perforato - poinçonné - perforado

		S	B	HC	L	V	A	B	C	D	E	F	G	H	I	OE - #	
24.0124-0179.1	424179		B			V	278,0	24,0	22,0	44,5	108,0	5	63,5	136,0	13,7	FORD	1361298 1361300 4367104 4367106 4455980 4457985 2T14-1125-CC 2T14-1125-EC
24.0124-0181.1	424181	S	B	HC		V	310,0	24,0	22,4	77,0	120,0	5	79,0	161,0	14,5	BMW	34 11 6 764 021
24.0124-0182.1	424182					V	276,0	24,0	22,4	45,0	114,3	5	69,0	145,0	12,5	DAEWOO	MR449817 MR449818
24.0124-0183.1	424183		B	HC	L	●	299,0	24,0	22,0	65,0	130,0	5	103,0	180,0	15,4	PORSCHE	993 352 041 02
24.0124-0184.1	424184		B			V	257,0	24,0	22,1	46,7	114,3	4	69,0	141,5	12,7	HYUNDAI	51712-2D310
24.0124-0185.1	424185		B			V	258,0	24,0	22,0	48,5	100,0	4	57,0	143,6	13,0	KIA	0K2N1-33-251
24.0124-0186.1	424186			HC		V	370,0	24,0	22,4	67,0	120,0	5	79,0	185,0	16,5	BMW	34 21 1 166 131
24.0124-0187.1	424187		B			V	254,0	24,0	22,0	50,7	100,0	4	55,0	141,0	13,0	KIA	41712-FD-300
24.0124-0188.1	424188		B	HC	L	V	278,0	24,0	21,4	55,5	112,0	5	67,0	164,0	15,0	MERCEDES BENZ	124 423 08 12
24.0124-0189.1	424189			HC	L	V	282,5	24,0	22,6	35,0	126,0	5	107,0	145,0	8,4	PORSCHE	911 351 041 22
24.0124-0190.1	424190			HC	L	V	290,0	24,0	22,6	83,0	130,0	5	90,0	180,0	15,4	PORSCHE	911 352 041 08
24.0124-0191.1	424191	S	B	HC		V	300,0	24,0	21,8	43,9	100,0	4	61,0	139,8	13,5	RENAULT	77 01 207 897 86 71 017 844
24.0124-0192.1	424192		B			V	256,0	24,0	21,5	45,6	114,3	4	69,0	139,0	12,7	MITSUBISHI	4605A068
24.0124-0193.1	424193					V	282,5	24,0	22,4	38,0	114,3	5	73,5	144,0	14,0	CHRYSLER	454 420 00 01 4509 340
24.0124-0194.1	424194		B	HC	L	●	299,0	24,0	22,0	67,0	130,0	5	98,0	180,0	15,4	PORSCHE	986 352 403 01 987 352 403 00
24.0124-0195.1	424195					V	274,0	24,1	22,0	40,4	114,3	5	72,0	142,5	13,0	KIA	0K552-33-251 0K552-33-251A 0K56A-33-251 KJ002-33-251C
24.0124-0196.1	424196		B			V	293,5	24,0	22,0	56,7	100,0	5	58,0	129,0	13,0	SUBARU	26300AE061 26300SA001
24.0124-0197.1	424197	S	B	HC		V	300,0	24,0	22,4	73,5	120,0	5	79,0	152,0	14,5	BMW	34 11 6 764 643 34 11 6 854 998
24.0124-0198.1	424198					V	300,0	24,0	22,0	44,5	108,0	4	63,5	156,5	13,7	FORD	4328921 4410264
24.0124-0199.1	424199	S	B			V	256,0	24,0	21,0	46,8	114,3	4	60,0	141,0	12,6	CHEVROLET/DAEWOO	96264591 96328338 96549782
24.0124-0200.1	424200	S	B	HC		V	330,0	24,0	22,4	73,3	120,0	5	79,0	174,0	14,5	BMW	34 11 6 854 999
24.0124-0201.2	424201	S	B	HC		V	345,0	24,0	22,4	63,2	120,0	5	75,0	185,0	14,5	BMW	34 21 6 763 827
24.0124-0202.1	424202					V	276,0	24,0	22,4	45,2	114,3	6	93,0	137,0	10,6	MITSUBISHI	MB895730
24.0124-0203.1	424203	S	B	HC		V	312,0	23,9	22,4	73,7	120,0	5	79,0	152,0	14,5	BMW	34 11 6 792 219 34 11 6 855 006
24.0124-0207.1	424207					V	254,0	24,0	22,4	39,0	108,0	6	67,0	132,6	10,6	MITSUBISHI	MB950958
24.0124-0210.1	424210		B	HC	L	●	298,0	24,0	22,0	67,0	130,0	5	98,0	164,0	15,4	PORSCHE	987 351 402 01
24.0124-0211.1	424211		B	HC	L	●	298,0	24,0	22,0	67,0	130,0	5	98,0	164,0	15,4	PORSCHE	987 351 401 01
24.0124-0212.1	424212	S	B	HC	L	V	320,0	24,0	21,4	58,2	112,0	5	67,0	180,0	15,2	MERCEDES BENZ	221 423 10 12
24.0124-0213.1	424213		B	HC		V	345,0	24,0	22,4	74,0	120,0	5	79,0	185,0	16,5	BMW	34 21 6 864 054
24.0124-0214.1	424214		B	HC		V	370,0	24,0	22,4	74,0	120,0	5	79,0	185,0	16,5	BMW	34 21 6 765 891
24.0124-0215.1	424215		B			V	294,0	24,0	22,4	45,5	114,3	5	69,0	147,8	12,6	CITROEN	16 063 757 80 16 114 298 80 4249 59
24.0124-0216.1	424216	S	B	HC		V	345,0	24,0	22,4	78,5	120,0	5	75,0	185,0	16,5	BMW	34 21 6 793 246
24.0124-0217.1	424217		B			V	302,5	24,0	22,0	45,0	114,3	5	72,0	144,0	13,0	MAZDA	F152-33-251A
24.0124-0218.1	424218		B			V	322,6	24,0	22,0	45,0	114,3	5	72,0	144,0	13,0	MAZDA	F160-33-251A
24.0124-0219.2	424219	S	B	HC		V	385,0	24,0	22,4	78,5	120,0	5	75,0	185,0	16,5	BMW	34 21 6 779 535
24.0124-0220.1	424220					V	254,0	24,0	22,4	40,0	108,0	5	87,0	153,5	10,6	HYUNDAI	58129-4A000
24.0124-0221.1	424221	S	B	HC		V	280,0	24,0	21,8	44,0	114,3	5	68,0	140,0	15,8	DACIA	40 20 641 51R
24.0124-0222.1	424222	S	B	HC		V	280,0	24,0	21,8	44,0	108,0	5	61,0	140,0	15,8	RENAULT	40 20 600 10R
24.0124-0223.1	424223	S	B	HC		V	280,0	24,0	21,8	44,0	108,0	5	61,0	140,0	15,8	MERCEDES BENZ	415 420 00 01 415 420 07 01 82 01 464 604
24.0124-0224.1	424224	S	B	HC		V	300,0	24,0	21,8	44,0	108,0	5	61,0	140,0	15,8	RENAULT	77 01 208 848
24.0124-0226.1	424226	S	B	HC	L	●	320,0	24,0	22,0	58,2	112,0	5	67,0	180,0	15,2	RENAULT	77 01 208 849
24.0124-0228.1	424228		B			V	294,0	24,0	21,0	87,5	108,0	8	84,0	142,0	10,5	MERCEDES BENZ	230 423 15 12
24.0124-0229.1	424229		B			V	263,0	24,0	22,0	53,0	118,0	6	96,0	144,0	M12x1,5	IVECO	2996043
																NISSAN	40206-F3901

Abmessungen Bremsscheiben

Dimensions brake discs - Misure dischi freno -

Dimensions Disques de frein - Medidas disco de freno

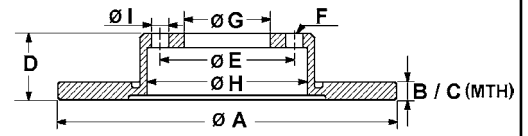

S Fixierschraube - fixing screw - vite di riparazione - vis de fixation - tornillo quefija

B beschichtet - coated - rivestito - revêtu - recubierto

HC hochgekohlt - high carbon - ad alto tenore di carbonio - à haute teneur en carbone - altamente carbonizado

L legiert - alloyed - alligato/legato - allié - aleado

V ventiliert - ventilated - ventilato - ventilé - ventilado

● gelocht - perforated - perforato - poinçonné - perforado

		S	B	HC	L	V	A	B	C	D	E	F	G	H	I	OE	#
24.0124-0231.2	424231	S	B	HC		●	350,0	24,0	22,4	66,5	120,0	5	75,0	185,0	14,5	BMW	34 21 2 283 803
24.0124-0232.2	424232	S	B	HC		●	350,0	24,0	22,4	66,5	120,0	5	75,0	185,0	14,5	BMW	34 21 2 283 804
24.0124-0233.2	424233	S	B	HC		V	345,0	24,0	22,4	69,0	120,0	5	75,0	185,0	16,5	BMW	34 21 6 775 289
24.0124-0234.2	424234	S	B	HC		●	370,0	24,0	22,4	61,6	120,0	5	75,0	185,0	14,5	BMW	34 21 2 282 808
24.0124-0235.2	424235	S	B	HC		●	370,0	24,0	22,4	61,6	120,0	5	75,0	185,0	14,5	BMW	34 21 2 282 807
24.0124-0236.1	424236	S	B	HC	L	V	320,0	24,0	21,4	68,2	112,0	5	67,0	180,0	15,2	MERCEDES BENZ	000 423 11 12 219 423 00 12
24.0124-0237.1	424237		B			V	278,0	24,0	22,0	47,3	114,3	4	60,0	141,0	12,5	CHEVROLET	96329364
24.0124-0238.1	424238		B			V	280,0	24,0	22,0	44,0	114,3	4	68,0	143,2	13,0	NISSAN	40206-EM10A 40206-ET01C
24.0124-0239.2	424239	S	B	HC		V	330,0	24,0	22,4	66,0	120,0	5	75,0	172,0	16,5	BMW	34 11 6 794 429
24.0124-0240.1	424240	S	B	HC		V	307,0	24,0	22,4	45,2	120,0	5	79,0	152,0	16,5	MINI	34 11 9 804 829
24.0124-0241.1	424241	S	B	HC		V	370,0	23,9	22,4	69,0	120,0	5	75,0	185,0	16,6	BMW	34 21 6 775 291
24.0124-0242.2	424242	S	B	HC		V	330,0	24,0	22,4	73,1	120,0	5	79,0	171,8	14,5	BMW	34 11 6 782 601
24.0124-0243.1	424243		B	HC	L	V	254,5	24,0	22,4	40,0	108,0	5	87,0	152,5	10,6	HYUNDAI	58129-4A100
24.0124-0245.1	424245		B	HC		V	256,0	24,0	22,0	24,0	108,0	6	86,0	155,0	10,8	FORD	4883102 6M34-1027-CA
24.0124-0247.1	424247		B			V	280,0	24,0	22,0	44,0	114,3	5	68,0	144,0	12,7	NISSAN	40206-1KA3A
24.0124-0250.2	424250	S	B	HC		V	345,0	24,0	22,4	66,1	120,0	5	75,0	160,8	16,5	BMW	34 20 6 797 605
24.0124-0251.2	424251	S	B	HC		V	345,0	24,0	22,4	66,2	120,0	5	75,0	185,0	16,5	BMW	34 20 6 797 607
24.0124-0253.1	424253	S	B	HC		V	280,0	24,0	21,8	44,0	100,0	4	61,0	140,0	13,5	RENAULT	40 20 605 40R 40 20 695 18R
24.0124-0702.1	424702		B			V	280,0	24,0	22,7	81,5	114,3	5	72,0	159,0	15,5	JEEP	5015 965AA
24.0124-0706.1	424706					V	257,0	24,0	22,4	45,5	114,3	4	69,0	141,5	12,5	HYUNDAI	51712-38100
24.0124-0723.1	424723					V	256,0	24,0	21,0	46,8	114,3	5	60,0	137,0	12,6	DAEWOO	96238673
24.0124-0724.1	424724					V	314,0	24,0	22,4	45,2	108,0	6	87,0	136,0	10,6	MITSUBISHI	MB699716
24.0124-0735.1	424735		B			V	278,0	24,0	22,0	47,0	114,3	5	72,0	143,0	14,2	FORD	4096352 4668068
																MAZDA	EC02-33-25X EF9Y-33-25X
24.0125-0100.1	425100			HC		V	280,0	25,0	23,4	78,0	120,0	5	74,0	144,0	14,5	BMW	34 11 1 121 902 34 11 1 152 296 34 11 1 163 141
24.0125-0102.1	425102			HC	L	V	276,0	25,0	23,0	46,5	112,0	5	68,0	135,0	15,4	AUDI	447 615 301 A 447 615 301 B
24.0125-0104.1	425104			HC		V	282,0	25,0	23,4	76,0	120,0	5	79,0	146,0	14,5	BMW	34 11 1 163 147
24.0125-0105.1	425105		B	HC		V	288,0	25,0	23,0	46,5	112,0	5/9	68,0	135,0	15,4	AUDI/SEAT/SKODA	4A0 615 301 C 4A0 615 301 D 8E0 615 301 Q
24.0125-0106.1	425106		B	HC		V	276,0	25,0	23,0	56,5	108,0	4	68,0	135,0	15,4	AUDI	895 615 301 B
24.0125-0107.1	425107		B	HC	L	V	294,0	25,0	22,4	49,5	112,0	5	67,0	154,3	15,0	MERCEDES BENZ	124 421 24 12
24.0125-0108.1	425108		B	HC		V	288,0	25,0	23,0	28,5	100,0	5	65,0	136,0	15,6	VOLKSWAGEN	3A0 615 301 A
24.0125-0110.1	425110	S	B	HC	L	V	288,0	25,0	22,4	46,5	112,0	5	67,0	154,3	13,2	CHRYSLER	5098 063AA
																MERCEDES BENZ	203 421 03 12 210 421 07 12 210 421 24 12
24.0125-0113.1	425113	S	B	HC		V	288,0	25,0	22,0	34,5	100,0	5	65,0	136,0	15,6	AUDI/SEAT/SKODA/VW	1J0 615 301 R 1J0 615 301 S 6R0 615 301 A
24.0125-0114.1	425114	S	B	HC		V	288,0	25,1	21,0	55,4	112,0	5	68,2	144,2	16,5	FORD	1045994
24.0125-0115.1	425115		B	HC		V	282,5	25,0	23,0	46,5	112,0	5	68,0	135,0	15,3	SEAT/VW	7M0 615 301 G
24.0125-0116.1	425116					V	255,0	25,0	23,0	52,6	114,3	5	62,0	147,0	14,4	VOLKSWAGEN	8E0 615 301 A 8E0 615 301 C
24.0125-0117.1	425117		B	HC		V	278,0	25,0	23,0	48,5	108,0	5	63,5	140,0	13,7	TOYOTA	43512-28060
																FORD	1373369 1734696 AV61-1125-BB 31262718
24.0125-0118.1	425118					V	257,0	25,0	23,0	46,6	110,0	5	84,0	145,0	M10x1,25	VOLVO	43512-26040 43512-26070 43512-35170 43512-35180
																TOYOTA	J43 512 351 80
24.0125-0119.1	425119	S	B	HC	L	V	288,0	25,0	22,0	42,0	110,0	5/7	70,0	139,0	14,0	VOLKSWAGEN	5 69 056/90512029
																OPEL/VAUXHALL	32025723
																SAAB	5390786
24.0125-0123.1	425123		B	HC		V	310,0	25,0	22,0	34,5	100,0	5/9	65,0	185,0	15,6	AUDI/SEAT/SKODA/VW	6R0 615 301 B 8N0 615 301 A 8L0 615 301
24.0125-0124.1	425124		B			V	255,0	24,9	24,0	49,2	100,0	5	55,0	156,0	14,5	AUDI/VW	43512-20470 43512-20580 43512-20700
																TOYOTA	4002143
24.0125-0125.1	425125					V	280,0	25,0	23,0	44,0	108,0	4	68,0	144,0	15,0	SAAB	4002143
24.0125-0126.1	425126					V	271,0	25,0	23,0	52,8	114,3	5	62,0	147,0	14,6	TOYOTA	43512-28100

Abmessungen Bremsscheiben

Dimensions brake discs - Misure dischi freno -

Dimensions Disques de frein - Medidas disco de freno

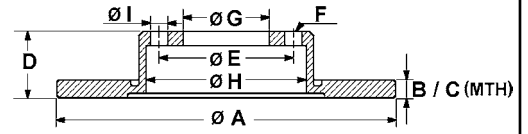

S Fixierschraube - fixing screw - vite di riparazione - vis de fixation - tornillo quejija L legiert - alloyed - alligato/legato - allié - aleado ● gelocht - perforated - perforato - poinçonné - perforado
 B beschichtet - coated - rivestito - revêtu - recubierto V ventiliert - ventilated - ventilato - ventilé - ventilado
 HC hochgekohlt - high carbon - ad alto tenore di carbonio - à haute teneur en carbone - altamente carbonizado

		S	B	HC	L	V	A	B	C	D	E	F	G	H	I	OE - #	
24.0125-0129.1	425129					V	258,0	25,0	24,0	47,0	114,3	5	62,0	161,5	14,5	TOYOTA	43512-17070
24.0125-0130.1	425130					V	282,0	25,0	23,0	34,5	114,3	4	92,0	171,0	M10x1,25	HONDA	45251-SM5-A00
24.0125-0131.1	425131	S	B	HC	L	V	280,0	24,8	22,0	42,0	110,0	5/7	70,0	139,0	14,0	OPEL/VAUXHALL	5 69 066/93197592
24.0125-0135.1	425135					V	291,0	25,0	23,0	65,8	127,0	6	100,0	155,0	10,7	TOYOTA	43512-35200
24.0125-0136.1	425136			HC		V	256,0	25,0	23,0	39,5	100,0	4	65,0	132,2	13,6	VOLKSWAGEN	6N0 615 301 E
24.0125-0137.1	425137		B	HC		V	312,0	25,0	23,0	46,5	112,0	5	68,0	158,0	15,3	AUDI/SEAT/SKODA	4B0 615 301 A 8E0 615 301 R
24.0125-0138.1	425138	S	B	HC		V	325,0	24,9	23,4	52,6	120,0	5	79,0	174,0	14,5	BMW	34 10 1 166 071 34 11 6 864 047
24.0125-0139.1	425139		B	HC	L	V	276,0	24,9	23,0	56,5	112,0	5	68,0	135,0	15,5	AUDI	895 615 301 D
24.0125-0140.1	425140		B			V	260,0	25,0	23,0	49,2	100,0	5	55,0	131,0	14,5	TOYOTA	43512-05030
24.0125-0141.1	425141	S	B	HC		V	285,0	24,9	22,0	42,1	110,0	5/7	70,0	139,0	14,0	FIAT	51819733 71772553
24.0125-0142.1	425142	S	B	HC	L	V	308,0	25,0	22,0	42,0	110,0	5/8	70,0	139,0	14,0	OPEL/VAUXHALL	5 69 061/9194477
24.0125-0143.1	425143		B			V	275,0	25,0	23,0	49,3	114,3	5	62,0	144,0	14,5	TOYOTA	43512-42030
24.0125-0144.1	425144					V	277,0	25,0	23,0	46,2	100,0	5	54,0	131,0	14,5	TOYOTA	43512-20390
24.0125-0145.1	425145	S	B	HC		V	288,0	25,0	22,0	49,9	112,0	5/9	65,0	144,0	15,3	AUDI/SEAT/SKODA/VW	1K0 615 301 T JZW 615 301 J
24.0125-0146.1	425146		B			V	282,0	25,0	23,0	47,0	114,3	4	64,0	142,5	13,0	VOLKSWAGEN	5C0 615 301 A
24.0125-0147.1	425147		B			V	282,5	25,0	23,0	48,5	114,3	5	72,0	142,0	13,0	HONDA	45251-S1A-G00
24.0125-0148.1	425148	S	B	HC	L	V	280,0	25,0	22,0	42,0	100,0	4/6	60,0	139,0	14,5	MAZDA	GJ6Y-33-25XA
24.0125-0149.1	425149		B	HC		V	314,0	25,0	23,0	59,7	112,0	5	68,0	144,0	15,3	OPEL/VAUXHALL	5 69 006/93175376
24.0125-0155.1	425155		B			V	255,0	25,0	23,0	49,3	100,0	4	55,0	131,0	14,5	AUDI	4F0 615 301 D
24.0125-0156.1	425156		B			V	276,0	25,0	23,0	49,2	100,0	5	55,0	131,0	14,5	TOYOTA	43512-02070
24.0125-0157.1	425157		B			V	275,0	25,0	23,0	49,2	100,0	4	55,0	129,0	14,5	TOYOTA	43512-13030 43512-47020
24.0125-0158.1	425158	S	B	HC		V	312,0	25,0	22,0	49,9	112,0	5/9	65,0	146,0	15,3	AUDI/VW/SKODA	1K0 615 301 AA JZW 615 301 H
24.0125-0160.1	425160	S	B	HC		V	325,0	25,0	23,4	62,2	120,0	5	75,0	174,0	16,5	VOLKSWAGEN	5C0 615 301 B
24.0125-0161.1	425161					V	282,0	25,0	23,0	44,5	100,0	4	64,2	143,0	12,6	BMW	34 11 3 400 151
24.0125-0162.1	425162		B	HC		V	300,0	25,0	23,0	48,5	108,0	5	63,5	140,0	13,7	MG	SDB000440
24.0125-0164.1	425164		B			V	297,0	25,0	22,0	64,7	120,0	5	70,0	161,5	14,3	FORD	1253965 1373370 1520297 1797226
24.0125-0165.1	425165		B	HC		V	278,0	25,0	23,0	48,5	114,3	5	72,0	140,0	14,0	LAND ROVER	NTC8780
24.0125-0167.1	425167	S	B	HC	L	V	288,0	25,0	22,4	44,5	112,0	5	67,0	154,3	15,3	MAZDA	BP4Y-33-25XC C24Y-33-25XB C24Y-33-25XC C24Y-33-25XD
24.0125-0168.1	425168		B			V	275,0	25,0	23,0	49,2	100,0	4	55,0	131,0	14,6	MERCEDES BENZ	169 421 11 12
24.0125-0170.1	425170		B	HC		V	300,0	25,0	23,0	48,5	114,3	5	72,0	140,0	14,0	TOYOTA	43512-13022
24.0125-0171.1	425171		B	HC		V	288,0	25,0	23,0	46,5	112,0	5/10	68,0	137,0	15,3	MAZDA	BP6Y-33-25XE C26Y-33-25XB
24.0125-0172.1	425172		B	HC		V	312,0	25,0	23,0	46,5	112,0	5/10	68,0	140,0	15,3	SKODA/VW	4B0 615 301 B
24.0125-0173.1	425173	S	B			V	300,0	25,0	23,0	47,2	114,3	5	64,1	141,0	12,7	SKODA/VW	4B0 615 301 C
24.0125-0174.1	425174		B			V	300,0	25,0	23,0	47,2	114,3	5	64,2	142,0	12,6	HONDA	45251-SM6-A10
24.0125-0176.1	425176		B			V	297,5	25,0	22,0	91,5	120,0	5	70,1	161,1	14,3	HONDA	45251-SEA-E30
24.0125-0177.1	425177		B			V	257,0	24,5	22,4	47,6	114,3	4	69,0	141,5	12,5	LAND ROVER	SDB000380
24.0125-0178.1	425178		B			V	275,0	25,0	22,0	46,5	114,3	5	62,0	145,0	14,5	KIA	51712-3C000
24.0125-0179.1	425179	S	B	HC	L	V	288,0	25,0	22,4	64,5	112,0	5	67,0	154,3	15,2	TOYOTA	43512-42040
24.0125-0182.1	425182	S				V	300,0	25,0	23,0	47,1	114,3	5	64,1	141,0	12,7	MERCEDES BENZ	000 421 19 12
24.0125-0183.1	425183					V	282,0	25,0	23,0	47,0	114,3	5	64,1	142,5	13,0	HONDA	45251-S9A-E50
24.0125-0184.1	425184	S	B	HC		V	314,0	25,0	23,0	52,4	112,0	5	68,0	154,0	15,3	HONDA	45251-S1A-E40 45251-S9A-E50
24.0125-0187.1	425187		B			V	280,0	25,0	23,0	47,2	114,3	5	64,1	142,2	13,0	AUDI	8K0 615 301
24.0125-0188.1	425188		B			V	299,0	25,0	23,0	48,4	114,3	5	72,0	142,8	13,0	HONDA	45251-SEA-E00
24.0125-0189.1	425189	S	B			V	281,5	25,0	23,0	47,2	114,3	5	64,1	142,5	12,5	MAZDA	G33Y-33-25X
24.0125-0190.1	425190		B			V	294,5	25,0	23,0	49,0	114,3	5	62,0	154,0	12,6	HONDA	45251-SJH-E10
						V										SUZUKI	55211-65J00



Abmessungen Bremsscheiben

Dimensions brake discs - Misure dischi freno -

Dimensions Disques de frein - Medidas disco de freno

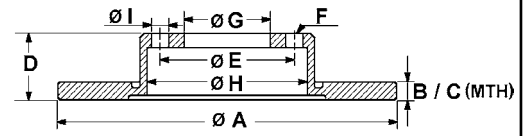

S Fixierschraube - fixing screw - vite di riparazione - vis de fixation - tornillo quefija

B beschichtet - coated - rivestito - revêtu - recubierto

HC hochgekohlt - high carbon - ad alto tenore di carbonio - à haute teneur en carbone - altamente carbonizado

L legiert - alloyed - alligato/legato - allié - aleado

V ventiliert - ventilated - ventilato - ventilé - ventilado

● gelocht - perforated - perforato - poinçonné - perforado

		S	B	HC	L	V	A	B	C	D	E	F	G	H	I	OE - #	
24.0125-0195.1	425195	B		HC		V	320,0	25,0	23,0	48,5	114,3	5	72,0	148,0	13,7	MAZDA	B37F-33-25XA
24.0125-0196.1	425196	B				V	255,0	25,0	22,0	49,2	100,0	5	55,0	136,0	14,5	TOYOTA	43512-47040
24.0125-0197.1	425197	B		HC		V	320,0	25,0	23,0	48,5	108,0	5	63,5	148,0	13,7	FORD	1724956
																VOLVO	3M51-2C375-CE 31302573 31329122 31341644 31381376 31400818 31400938 31400942
24.0125-0198.1	425198	S	B	HC	L	V	280,0	25,0	22,0	43,2	100,0	4/6	60,0	139,0	14,5	OPEL/VAUXHALL	5 69 007/93181113 5 69 067/93197712
24.0125-0199.1	425199		B	HC		V	278,0	25,0	23,0	48,5	108,0	5	63,5	140,0	13,7	FORD	1790221
24.0125-0200.1	425200	S	B	HC	L	V	280,0	25,0	22,4	51,0	112,0	5	67,0	144,5	15,0	MERCEDES BENZ	AV61-1125-DB 246 421 11 12
24.0125-0700.1	425700					V	275,0	25,0	23,0	49,2	100,0	5	55,0	129,0	14,5	TOYOTA	42512-20711
24.0125-0706.1	425706					V	300,0	25,0	23,0	39,7	114,3	5	70,2	142,5	12,6	HONDA	45251-S2A-000
24.0126-0100.1	426100			HC	L	V	283,0	26,0	24,0	48,0	108,0	5	71,0	130,5	13,0	CITROEN	95 661 813 96 099 616
																PEUGEOT	4246 N8
24.0126-0101.1	426101	B				V	280,3	26,0	23,0	50,3	108,0	4	68,0	139,0	14,5	VOLVO	271590
24.0126-0102.1	426102	B				V	280,3	26,0	23,0	50,3	108,0	5	68,0	139,0	14,5	VOLVO	271788 272312
24.0126-0103.1	426103					V	281,0	26,0	24,2	43,7	98,0	5	59,0	127,0	13,0	ALFA ROMEO	60621051
24.0126-0104.1	426104	B				V	281,0	26,0	24,2	43,7	98,0	5	59,0	127,0	16,5	CITROEN	4246 J3 4249 H5
																FIAT/LANCIA PEUGEOT	1317651080 4246 J2 4249 H5
24.0126-0105.1	426105	B				V	280,0	26,0	23,0	56,3	108,0	5	68,0	139,0	14,0	VOLVO	31262209 3516567 6848902
24.0126-0106.1	426106	S	B			V	283,0	26,0	24,2	28,2	108,0	4	66,0	133,5	13,0	CITROEN PEUGEOT	4246 L8 4246 R7
24.0126-0107.1	426107	B		HC		V	302,0	26,0	23,0	50,0	108,0	5	68,0	151,0	14,4	VOLVO	272276
24.0126-0108.1	426108	B				V	257,0	26,0	24,0	52,5	114,3	5	68,0	139,5	12,8	NISSAN	40206-9C100 40206-9C101
24.0126-0109.1	426109					V	277,0	26,0	24,0	39,0	124,0	6	100,0	164,0	M10x1,25	FORD NISSAN	1954433 40206-0F000 40206-0F001 40206-31G01
24.0126-0111.1	426111	B				V	280,0	26,0	24,6	36,0	109,0	6	88,0	175,0	M12x1,25	ISUZU	97034034 97034035
																OPEL/VAUXHALL	5 69 050/97034034 5 69 051/97034035
24.0126-0112.1	426112					V	257,0	26,0	24,0	45,5	100,0	4	61,0	148,0	12,8	NISSAN	40206-54C01
24.0126-0114.1	426114					V	281,0	26,0	24,2	54,2	98,0	5	59,0	127,0	13,2	LANCIA	82476515
24.0126-0115.1	426115	B		HC		V	300,0	26,0	22,0	56,0	112,0	5	68,2	144,0	16,5	FORD	1141782
24.0126-0116.1	426116	B		HC		V	303,0	26,0	23,0	51,5	112,0	5	67,0	168,0	15,0	SEAT/VW MERCEDES BENZ	7M3 615 301 A 163 421 02 12 163 421 04 12
24.0126-0119.1	426119	B		HC		V	313,0	25,9	22,0	56,2	112,0	5	68,2	148,0	16,5	FORD	1108038
24.0126-0120.1	426120	S	B			V	283,0	26,0	24,0	34,2	108,0	4	66,0	133,5	13,0	SEAT/VW CITROEN	7M3 615 301 4246 W2 4249 18 4249 84 4249 J6 16 064 014 80
																PEUGEOT	4246 W8 4249 17 4249 84 4249 J6
24.0126-0121.1	426121	S	B	HC	L	V	283,0	26,0	24,0	48,3	108,0	5	71,1	133,0	13,2	PEUGEOT	4246 P7 4246 V4 4249 L3
24.0126-0122.1	426122	B				V	285,5	26,0	23,0	50,3	108,0	5	68,0	139,0	16,5	VOLVO	272403 946133
24.0126-0123.1	426123	B		HC		V	300,0	26,0	22,8	47,0	108,0	5	61,0	139,6	13,5	RENAULT	82 00 007 122 86 71 016 878
24.0126-0125.1	426125	B				V	281,0	26,0	24,2	43,5	98,0	4	59,0	127,0	13,0	FIAT	46535086 46765546
24.0126-0126.1	426126	B				V	276,0	26,0	24,0	46,2	114,3	5	69,0	141,5	12,6	HYUNDAI	51712-3B000
24.0126-0127.1	426127	B				V	294,0	26,0	24,4	46,1	114,3	5	69,0	145,0	12,6	HYUNDAI	51712-26100

Abmessungen Bremsscheiben

Dimensions brake discs - Misure dischi freno -

Dimensions Disques de frein - Medidas disco de freno

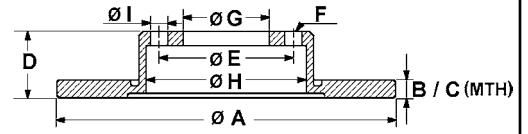

S Fixierschraube - fixing screw - vite di riparazione - vis de fixation - tornillo quefija
 B beschichtet - coated - rivestito - revêtu - recubierto
 HC hochgekohlt - high carbon - ad alto tenore di carbonio - à haute teneur en carbone - altamente carbonizado
 L legiert - alloyed - alligato/legato - allié - aleado
 V ventiliert - ventilated - ventilato - ventilé - ventilado
 ● gelocht - perforated - perforato - poinçonné - perforado

		S	B	HC	L	V	A	B	C	D	E	F	G	H	I	OE - #	
24.0126-0128.1	426128		B				280,0	26,0	24,4	47,4	114,3	5	69,0	141,5	12,5	HYUNDAI KIA 51712-3K050 51712-1F000 51712-2C000 51712-3K050	
24.0126-0129.1	426129		B			V	280,0	26,0	24,4	47,3	114,3	4	69,0	141,4	12,7	HYUNDAI 51712-3C100 51712-3D300	
24.0126-0130.1	426130		B			V	305,0	26,0	24,5	63,5	127,0	5	72,0	170,0	15,5	JEEP 5209 8672	
24.0126-0131.1	426131		B			V	276,0	26,0	24,4	45,5	114,3	4	69,0	145,0	12,5	MITSUBISHI MR510742	
24.0126-0133.1	426133					V	281,0	26,0	24,2	47,2	108,0	5/10	59,0	134,0	14,5	ALFA/FIAT 46449390 60814639 71739635	
24.0126-0134.1	426134		B			V	276,0	26,0	24,4	45,5	114,3	5	69,0	145,0	12,5	MITSUBISHI MR510966	
24.0126-0135.1	426135		B			V	274,0	26,2	24,0	48,5	114,3	5	72,0	140,5	13,0	KIA 0K55A-33-251 0K55B-33-251	
24.0126-0136.1	426136		B	HC	L	V●	330,0	26,0	24,0	68,2	112,0	5	67,0	180,0	15,0	MERCEDES BENZ 211 423 11 12	
24.0126-0137.1	426137		B	HC	L	V●	330,0	26,0	24,0	61,0	112,0	5	67,0	180,0	17,0	MERCEDES BENZ 220 423 09 12	
24.0126-0138.1	426138		B			V	295,0	26,0	24,0	49,2	114,3	5	62,0	141,0	14,5	TOYOTA 43512-0F010 43512-05080	
24.0126-0139.1	426139		B			V	277,0	26,0	24,0	49,5	100,0	5	55,0	129,0	14,5	TOYOTA 43512-05040	
24.0126-0140.1	426140		S	B		V	302,0	26,0	24,0	34,2	108,0	4	66,0	133,0	13,0	CITROEN 4249 33 96 876 021 80	
24.0126-0141.1	426141		B			V	295,0	26,0	24,0	49,5	100,0	5	55,0	141,0	14,5	PEUGEOT TOYOTA 43512-05050 43512-05070	
24.0126-0142.1	426142			HC		V	300,0	26,0	22,8	44,0	108,0	5	61,0	139,6	15,6	RENAULT 82 00 196 263	
24.0126-0143.1	426143		S	B	HC	L	V	280,0	26,0	24,0	48,5	114,3	4	72,0	143,5	13,0	KIA 0K2FA-33-251
24.0126-0144.1	426144			HC	L	V	290,0	26,0	23,0	70,0	96,0	8	70,0	135,0	14,5	MERCEDES BENZ 905 421 00 12	
24.0126-0145.1	426145		B			V	290,0	26,0	24,4	46,3	139,7	6	94,0	171,0	12,8	MITSUBISHI 4615A061 MR407116 MR407289	
24.0126-0146.1	426146		B	HC	L	V	278,0	26,0	23,0	43,3	110,0	5/7	70,0	136,0	14,0	OPEL/VAUXHALL 55 69 026/93188919	
24.0126-0148.1	426148		B			V	273,0	26,0	23,0	49,2	114,3	5	62,0	142,0	14,8	TOYOTA 43512-02180	
24.0126-0149.1	426149		S	B	HC	L	V	330,0	26,0	23,4	58,2	112,0	5	67,0	180,0	15,0	MERCEDES BENZ 230 423 08 12
24.0126-0150.1	426150		B	HC	L	V	280,0	26,0	24,4	47,2	114,3	5	69,0	143,5	12,5	HYUNDAI/KIA 51712-1H000 51712-1H100 51712-2K100	
24.0126-0151.1	426151		B			V	303,0	26,0	24,0	47,0	114,3	5	72,0	159,0	14,0	KIA 4668070	
24.0126-0152.2	426152		S	B	HC	V	338,0	25,9	24,4	73,0	120,0	5	79,0	171,5	14,5	FORD 34 11 6 778 647	
24.0126-0154.1	426154		B			V	295,5	26,0	24,0	44,0	114,3	5	68,0	146,5	12,7	NISSAN 40206-JD00A 40206-JG00A	
24.0126-0155.1	426155		S	B		V	275,0	26,0	24,0	47,3	114,3	4	69,0	141,6	13,0	KIA 51712-2F100	
24.0126-0156.1	426156		B			V	295,0	26,0	23,0	49,1	114,3	5	62,0	143,2	14,8	TOYOTA 43512-02190 43512-0F030 43512-12680	
24.0126-0157.1	426157		B			V	275,0	26,0	24,0	47,4	114,3	5	69,0	143,3	12,5	HYUNDAI 51712-2H000	
24.0126-0158.1	426158		S	B	HC	L	V	296,0	26,0	23,4	44,0	114,3	5	68,0	147,7	15,8	RENAULT 40 20 600 02R 40 20 668 13R 40 20 670 23R
24.0126-0159.1	426159		S	B		V	302,0	26,0	24,0	34,2	108,0	4	66,0	133,2	13,0	CITROEN 4249 81 4249 86 4249 J8 4249 64 4249 80 4249 81 4249 86 4249 J8	
24.0126-0160.1	426160		B			V	320,0	26,0	23,0	49,3	114,3	5	62,0	143,0	14,5	TOYOTA 43512-05090	
24.0126-0161.1	426161		B	HC	L	V	290,0	26,0	23,0	42,5	120,0	10	102,0	144,5	10,5	RENAULT 50 10 260 603	
24.0126-0162.1	426162		B			V	290,0	26,0	24,4	45,8	114,3	5	69,0	145,5	12,6	MITSUBISHI MN116979	
24.0126-0163.1	426163		B			V	290,0	26,0	23,0	53,0	118,0	6	96,0	134,0	M12x1,5	NISSAN 40206-9X403 NISSAN 40206-9X40B RENAULT 50 01 871 214	
24.0126-0164.1	426164		B			V	276,0	26,0	24,4	45,5	114,3	5	69,0	146,0	12,5	RENAULT MITSUBISHI MN116329 MN116330 4615A115 4615A190	
24.0126-0165.1	426165		S	B		V	276,0	26,0	23,0	45,5	105,0	5	60,0	139,0	14,2	CHEVROLET 13502045 13502824	
24.0126-0166.1	426166		S	B	HC	V	300,0	26,0	23,0	45,5	115,0	5	70,7	149,0	14,2	OPEL/VAUXHALL 5 69 073/13502044 CHEVROLET 13502052 OPEL/VAUXHALL 5 69 070/13502052 5 69 076/13502051 5 69 082/13503988	



Abmessungen Bremsscheiben

Dimensions brake discs - Misure dischi freno -

Dimensions Disques de frein - Medidas disco de freno

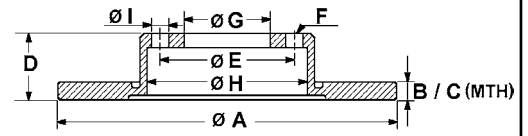

S Fixierschraube - fixing screw - vite di riparazione - vis de fixation - tornillo quejija

B beschichtet - coated - rivestito - revêtu - recubierto

HC hochgekohlt - high carbon - ad alto tenore di carbonio - à haute teneur en carbone - altamente carbonizado

L legiert - alloyed - alligato/legato - allié - aleado

V ventiliert - ventilated - ventilato - ventilé - ventilado

● gelocht - perforated - perforato - poinçonné - perforado

		S	B	HC	L	V	A	B	C	D	E	F	G	H	I	OE - #
24.0126-0168.1	426168	S	B			V	281,0	26,2	24,2	39,8	110,0	5/5	70,0	138,0	16,6/11,0	FIAT 51806278 51815312 51937306 51962485
24.0126-0169.1	426169		B			V	274,0	26,0	24,4	44,2	108,0	5	87,0	132,0	10,5	JEEP 58129-4A200
24.0126-0170.1	426170		B			V	294,0	26,0	24,4	45,8	114,3	5	69,0	145,0	13,1	HYUNDAI 16 075 005 80 CITROEN 5105 514AA CHRYSLER JEEP 5105 514AA MITSUBISHI 4615A117 PEUGEOT 16 075 005 80
24.0126-0171.1	426171		B	HC	L	V	280,0	26,0	24,0	47,3	114,3	5	69,0	141,5	12,6	KIA 51712-1D100
24.0126-0172.1	426172		B			V	300,0	26,0	24,0	49,5	114,3	5	62,0	150,2	12,8	SUZUKI 55311-57L00
24.0126-0174.1	426174		B	HC	L	V	376,0	26,0	24,0	42,0	108,0	5	64,5	167,6	14,0	JAGUAR C2P 13648
24.0126-0175.1	426175		B			V	257,0	26,0	24,0	53,7	114,3	4	68,0	144,0	12,8	NISSAN 40206-JX00A 40206-3LG0A
24.0126-0176.1	426176	S	B	HC	L	V	302,0	26,0	24,0	34,2	108,0	5	66,0	133,5	13,2	PEUGEOT 4249 F8
24.0126-0177.1	426177		B			V	296,0	26,0	24,0	44,0	114,3	5	68,0	146,0	12,7	NISSAN 40206-1KC1A 40206-1KC3A
24.0126-0180.1	426180	S	B	HC	L	V	280,0	26,0	23,8	45,0	108,0	5	61,0	139,8	15,8	MERCEDES BENZ 415 421 04 12
24.0127-0100.1	427100		B			V	281,0	27,0	25,4	42,7	108,0	6	87,0	136,0	10,6	HYUNDAI 51712-H1000
24.0127-0101.1	427101					V	276,0	27,0	25,4	45,2	108,0	6	87,0	136,0	10,6	MITSUBISHI MB928120
24.0128-0100.1	428100	S	B	HC	L	V●	295,0	28,0	26,0	64,5	112,0	5	67,0	154,3	15,2	MERCEDES BENZ 204 421 36 12
24.0128-0101.1	428101		B	HC		V	302,0	28,0	26,4	75,9	120,0	5	79,0	149,0	14,5	BMW 34 11 6 756 090
24.0128-0102.1	428102		B	HC	L	V	300,0	28,0	25,4	68,3	112,0	5	80,0	145,0	15,0	MERCEDES BENZ 126 421 05 12
24.0128-0103.1	428103		B	HC	L	V	300,0	28,0	25,4	45,5	112,0	5	67,0	154,3	15,0	MERCEDES BENZ 129 421 20 12
24.0128-0104.1	428104	S	B	HC	L	V	296,0	28,0	25,0	58,4	110,0	5	70,0	139,0	14,0	OPEL/VAUXHALL 5 69 044/90392559 5 69 016/93182283
24.0128-0105.1	428105	S	B	HC		V	316,0	28,0	26,4	77,0	120,0	5	79,0	159,0	14,5	BMW 34 11 6 757 752
24.0128-0106.1	428106	S	B	HC	L	V	300,0	28,0	25,4	46,5	112,0	5	67,0	154,0	13,3	CHRYSLER 5098 064AC MERCEDES BENZ 203 421 05 12 210 421 22 12 210 421 25 12
24.0128-0113.1	428113					V	255,0	28,0	26,0	49,2	100,0	5	55,0	131,0	14,5	TOYOTA 43512-05010
24.0128-0114.1	428114					V	255,0	28,0	26,0	49,1	114,3	5	62,0	146,5	14,6	TOYOTA 43512-33020
24.0128-0115.1	428115		B			V	275,0	28,0	26,0	49,2	114,3	5	62,0	158,5	14,8	TOYOTA 43512-07020 43512-33040 43512-33041 43512-33042 43512-33060 43512-44021
24.0128-0116.1	428116					V	255,0	28,0	26,0	49,3	100,0	5	55,0	155,5	14,5	TOYOTA 43512-05020
24.0128-0118.1	428118					V	310,0	28,0	26,0	47,3	108,0	5/10	59,0	141,5	14,7	ALFA ROMEO 60629865
24.0128-0119.1	428119					V	305,0	28,0	26,0	44,7	98,0	5	59,0	151,0	13,2	ALFA ROMEO 60652186 60670801
24.0128-0120.1	428120					V	305,0	28,0	26,0	44,7	98,0	4	59,0	151,0	13,2	FIAT 46465088 71738914
24.0128-0122.1	428122		B	HC		V	296,0	28,0	26,4	55,0	120,0	5	79,0	145,5	14,5	BMW 34 11 1 165 263
24.0128-0123.1	428123		B			V	305,0	27,9	25,0	50,3	108,0	5	68,0	139,0	16,5	VOLVO 274170 274559 9492715
24.0128-0125.1	428125		B	HC	L	V●	312,0	28,0	26,0	76,0	112,0	5	67,0	154,0	15,0	MERCEDES BENZ 220 421 09 12
24.0128-0126.1	428126		B	HC	L	V	316,0	28,0	25,4	46,5	112,0	5	67,0	154,3	13,0	MERCEDES BENZ 210 421 20 12
24.0128-0127.1	428127		B	HC	L	V	310,0	28,0	25,4	82,0	112,0	5	67,0	154,0	17,0	MERCEDES BENZ 140 421 03 12
24.0128-0128.1	428128	S	B			V	288,0	28,0	26,0	34,0	108,0	4	66,0	133,0	13,0	CITROEN 4246 T8 4246 W3
24.0128-0129.1	428129	S	B			V	305,5	28,0	25,0	77,8	130,0	5	90,0	157,0	15,8	NISSAN 40206-00QAD OPEL/VAUXHALL 44 03 038/9111038
24.0128-0130.1	428130		B	HC	L	V●	318,0	28,0	26,0	67,0	130,0	5	98,0	158,8	15,4	RENAULT 77 00 314 064 PORSCHE 996 351 406 02
24.0128-0131.1	428131		B	HC	L	V●	318,0	28,0	26,0	67,0	130,0	5	98,0	158,8	15,4	PORSCHE 996 351 405 02
24.0128-0132.1	428132	S	B	HC		V	305,0	28,0	24,0	49,7	118,0	5	72,0	154,0	15,5	NISSAN 40206-00QAE 40206-00QAF 40206-00QAG 40206-00QAH 44 14 632/91165426
24.0128-0133.1	428133		B	HC		V	324,0	28,0	25,4	47,0	108,0	5	61,0	150,0	15,5	OPEL/VAUXHALL 77 11 130 077 RENAULT 82 00 242 318 82 00 570 191 86 71 019 275
24.0128-0134.1	428134		B			V	305,0	28,0	26,0	44,0	108,0	5	61,0	132,0	15,5	RENAULT 77 01 206 673 86 71 012 049
24.0128-0135.1	428135		B	HC		V	308,0	28,0	25,8	47,0	108,0	5	61,0	140,0	15,5	RENAULT 82 00 242 317 82 00 570 677



Abmessungen Bremsscheiben

Dimensions brake discs - Misure dischi freno -

Dimensions Disques de frein - Medidas disco de freno

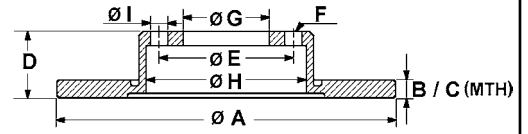

S Fixierschraube - fixing screw - vite di riparazione - vis de fixation - tornillo quefija

B beschichtet - coated - rivestito - revêtu - recubierto

HC hochgekohlt - high carbon - ad alto tenore di carbonio - à haute teneur en carbone - altamente carbonizado

L legiert - alloyed - alligato/legato - allié - aleado

V ventiliert - ventilated - ventilato - ventilé - ventilado

● gelocht - perforated - perforato - poinçonné - perforado

		S	B	HC	L	V	A	B	C	D	E	F	G	H	I	OE - #		
24.0128-0136.1	428136		B			V	285,0	28,0	26,0	43,7	98,0	5	59,0	127,0	16,5	CITROEN FIAT/LANCIA PEUGEOT	4246 P2 16 063 092 80 1325772080 4249 H7 16 063 092 80	
24.0128-0137.1	428137	S	B	HC		V	302,0	28,0	25,0	45,0	110,0	5/7	70,0	139,0	14,0	OPEL/VAUXHALL SAAB	5 69 004/93171500 9191247 93171500	
24.0128-0138.1	428138		B			V	291,0	28,1	26,0	64,8	120,7	5	80,0	175,0	13,5	JAGUAR	JLM 20341	
24.0128-0139.1	428139					V	275,0	28,0	26,0	50,8	114,3	5	60,1	143,5	14,5	LEXUS	43512-50060	
24.0128-0140.1	428140		B			V	280,0	28,0	26,0	49,1	114,3	5	68,0	144,0	12,8	NISSAN	40206-3Y502 40206-3Y503 40206-4U101 40206-4U103 40206-4U107	
24.0128-0142.1	428142		B	HC	L	V	312,0	28,0	25,4	64,5	112,0	5	67,0	154,0	15,3	MERCEDES BENZ	211 421 09 12	
24.0128-0143.1	428143					V	305,0	28,0	26,0	28,0	108,0	4	66,0	132,9	13,0	PEUGEOT	4246 V1	
24.0128-0144.1	428144		B	HC		V	316,0	28,0	25,0	50,0	108,0	5	68,0	144,0	16,5	VOLVO	30636074 30736406	
24.0128-0145.1	428145		B	HC	L	V	300,0	28,0	25,0	58,5	112,0	5	67,0	153,0	15,0	MERCEDES BENZ	447 421 05 12 639 421 00 12 639 421 03 12	
24.0128-0147.1	428147		B	HC		V	302,0	28,0	26,5	39,0	114,3	5	73,5	146,3	14,0	CHRYSLER	4683 918AB	
24.0128-0148.1	428148					V	281,0	28,0	25,3	38,0	114,3	5	73,5	146,0	14,0	CHRYSLER	5073 069AA 4721 820AG	
24.0128-0149.1	428149		B	HC		V	330,0	28,0	26,0	73,5	130,0	5	85,0	210,0	15,4	PORSCHE	955 352 401 30 955 352 401 31	
24.0128-0153.1	428153		B	HC		V	320,0	28,0	26,0	49,0	114,3	5	68,0	144,5	13,0	VOLKSWAGEN	7L6 615 601 J 7L8 615 601 C	
24.0128-0154.1	428154	S	B	HC		V	300,0	28,0	26,0	52,0	108,0	5	63,5	140,0	15,8	INFINITI NISSAN NISSAN FORD	40206-EG000 40206-CA010 40206-EG000 1420601 1469085 1500158 1517696 6G91-2C375-F1B 7G91-1125-BA	
24.0128-0155.1	428155		S	B	HC	L	V	295,0	28,0	25,4	64,5	112,0	5	67,0	154,3	15,2	MERCEDES BENZ	212 421 13 12
24.0128-0156.1	428156		S	B		V	280,0	28,0	25,0	54,5	111,0	5	93,0	136,0	M10x1,5	FORD	1371394 1503290 1547061 6C11-1125-B1B 6C11-1125-BB	
24.0128-0157.1	428157		S	B		V	300,0	28,0	25,0	54,5	111,0	5	93,0	136,0	M10x1,5	FORD	1371393 1503287 1546747	
24.0128-0158.1	428158		B			V	321,0	28,0	26,4	49,1	114,3	5	69,0	143,0	12,5	HYUNDAI	51712-2B700	
24.0128-0159.1	428159		B			V	296,0	28,0	25,0	49,2	114,3	5	62,0	145,0	14,5	LEXUS TOYOTA TOYOTA	43512-33140 43512-42050 43512-42090	
24.0128-0162.1	428162		S	B	HC	V	316,0	28,0	26,0	52,0	108,0	5	63,5	144,0	16,0	FORD	1434812 1434815	
24.0128-0163.1	428163		B	HC	L	V●	312,0	28,0	26,0	64,5	112,0	5	67,0	155,2	15,0	LAND ROVER VOLVO	LR000470 30769061	
24.0128-0164.1	428164		S	B	HC	V	314,0	28,0	25,0	44,9	110,0	5/7	70,0	139,0	14,0	MERCEDES BENZ	230 421 04 12	
24.0128-0165.1	428165			HC	L	V	298,0	28,0	26,0	50,0	126,0	5	107,0	156,0	8,4	OPEL/VAUXHALL SAAB	5 69 005/93175606 24435132 93175606	
24.0128-0166.1	428166					V	300,0	28,0	26,0	38,0	124,0	6	100,0	184,0	M10x1	PORSCHE	951 351 041 00	
24.0128-0167.1	428167		B	HC	L	V	298,0	28,0	26,0	74,0	130,0	5	103,0	157,0	15,4	NISSAN	40206-1W600 40206-6W500	
24.0128-0169.1	428169		B	HC	L	V	358,0	28,0	26,0	73,5	130,0	5	85,0	210,0	15,4	PORSCHE	951 351 041 01 951 351 041 02	
																AUDI/VOLKSWAGEN	7L8 615 601 A 7L8 615 601 D 7L8 615 601 E	
																PORSCHE	955 352 403 00 958 352 401 50	

Abmessungen Bremsscheiben

Dimensions brake discs - Misure dischi freno -

Dimensions Disques de frein - Medidas disco de freno

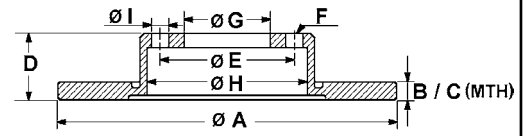

S Fixierschraube - fixing screw - vite di riparazione - vis de fixation - tornillo quefija

B beschichtet - coated - rivestito - revêtu - recubierto

HC hochgekohlt - high carbon - ad alto tenore di carbonio - à haute teneur en carbone - altamente carbonizado

L legiert - alloyed - alligato/legato - allié - aleado

V ventiliert - ventilated - ventilato - ventilé - ventilado

● gelocht - perforated - perforato - poinçonné - perforado

		S	B	HC	L	V	A	B	C	D	E	F	G	H	I	OE - #		
24.0128-0171.1	428171		B	HC	L	V●	309,0	28,0	26,0	83,0	130,0	5	103,0	180,0	15,4	PORSCHE	930 352 045 01	
24.0128-0172.1	428172		B	HC	L	V●	309,0	28,0	26,0	83,0	130,0	5	103,0	180,0	15,4	PORSCHE	930 352 046 01	
24.0128-0174.1	428174			HC	L	V	298,0	28,0	26,0	80,0	130,0	5	103,0	161,0	15,4	PORSCHE	964 351 041 02	
24.0128-0175.1	428175					V	273,5	28,0	26,0	51,0	114,3	5	72,0	142,8	13,0	MAZDA	T002-33-25XA TY01-33-25X	
24.0128-0176.1	428176		B	HC	L	V	295,0	28,0	25,4	54,5	112,0	5	67,0	154,0	15,3	MERCEDES BENZ	211 421 08 12	
24.0128-0177.1	428177		B	HC	L	V●	330,0	28,0	26,0	46,5	112,0	5	67,0	154,0	13,0	MERCEDES BENZ	203 421 13 12	
24.0128-0178.1	428178					V	288,0	28,0	26,0	50,0	108,0	5	71,0	130,5	13,0	CITROEN	4246 T2	
24.0128-0179.1	428179					V	305,5	28,0	26,0	44,8	108,0	5/10	59,0	138,9	14,6	LANCIA	46776750	
24.0128-0180.1	428180					V	296,0	28,0	26,0	51,0	114,3	5	72,0	142,8	13,0	MAZDA	L12Y-33-25X	
24.0128-0182.1	428182		B	HC		V	308,0	28,0	25,4	47,0	108,0	5	61,0	140,0	13,5	RENAULT	82 00 019 581	
24.0128-0183.1	428183		B			V	275,0	28,0	26,0	49,2	100,0	5	55,0	132,0	14,5	TOYOTA	43512-20601	
24.0128-0184.1	428184		B	HC		V	320,0	28,0	25,0	50,0	108,0	5	68,0	151,0	16,5	VOLVO	9475266	
24.0128-0185.1	428185		B	HC		V	305,0	28,0	26,0	44,7	110,0	5/7	70,0	138,0	14,2	FIAT	51757229 71772547	
24.0128-0186.1	428186		B			V	296,0	28,0	26,0	49,3	114,3	5	62,0	141,0	14,7	LEXUS	43512-48020 43512-48050	
24.0128-0188.1	428188		S	B	HC	L	V	330,0	28,0	26,0	46,5	112,0	5	67,0	154,0	13,0	MERCEDES BENZ	203 421 04 12
24.0128-0189.1	428189					V	285,0	28,0	26,0	45,5	127,0	6	84,0	149,0	M10x1,25	TOYOTA	43512-26140 43512-26160	
24.0128-0190.1	428190					V	296,0	28,0	26,0	49,2	114,3	5	62,0	156,0	14,7	TOYOTA	43512-33100 43512-28180 43512-28181	
24.0128-0191.1	428191		S	B		V	330,0	28,0	26,0	39,7	110,0	5	70,0	151,0	16,6	ALFA ROMEO	51760622 51767384	
																JEEP	0 4779 884AC 4779 884AC	
24.0128-0192.1	428192		S	B		V	305,0	28,0	26,0	39,7	110,0	5	70,0	138,0	16,6	ALFA ROMEO	51760621 51767381 51767382	
24.0128-0194.1	428194		B			V	338,0	28,0	26,0	67,5	139,7	6	108,0	172,0	14,5	LEXUS/TOYOTA	43512-60150 43512-60151	
24.0128-0195.1	428195					V	295,0	28,0	26,0	50,0	108,0	5	71,0	130,6	13,0	PEUGEOT	4246 L0	
24.0128-0196.1	428196		B	HC	L	V●	330,0	28,0	26,0	75,0	130,0	5	98,0	180,0	15,4	PORSCHE	996 352 406 00 996 352 406 01 996 352 406 02 996 352 406 03	
24.0128-0197.1	428197		B	HC	L	V●	330,0	28,0	26,0	75,0	130,0	5	98,0	180,0	15,4	PORSCHE	996 352 405 00 996 352 405 01 996 352 405 02 996 352 405 03	
24.0128-0198.1	428198		S	B	HC	V	315,0	28,0	26,4	52,5	120,0	5	79,0	152,0	14,5	BMW	34 11 2 227 171	
24.0128-0199.1	428199		S	B	HC	V	315,0	28,0	26,4	52,5	120,0	5	79,0	152,0	14,5	BMW	34 11 2 227 172	
24.0128-0200.1	428200		B			V	302,0	28,0	26,0	54,0	139,6	5	96,3	163,0	12,5	KIA	51712-3E000	
24.0128-0201.1	428201		B	HC	L	V	321,0	28,0	25,0	44,0	110,0	5/7	70,0	139,0	14,0	OPEL/VAUXHALL	5 69 017/93185814	
24.0128-0202.1	428202		B	HC	L	V	303,0	28,0	25,0	93,0	145,0	6	120,0	172,0	15,0	MERCEDES BENZ	906 421 01 12	
24.0128-0203.1	428203		S	B	HC	L	V	300,0	28,0	25,0	68,5	130,0	6	85,0	155,0	15,0	VOLKSWAGEN	2E0 615 601 MERCEDES BENZ 906 421 00 12 VOLKSWAGEN 2E0 615 301
24.0128-0204.2	428204		S	HC		V	315,0	28,0	26,4	52,5	120,0	5	79,0	155,0	14,5	BMW	34 11 2 227 737	
24.0128-0205.2	428205		S	B	HC	V	315,0	28,0	26,4	52,5	120,0	5	79,0	155,0	14,5	BMW	34 11 2 227 738	
24.0128-0206.2	428206		S	B	HC	V●	325,0	28,0	26,4	52,5	120,0	5	79,0	154,8	14,5	BMW	34 11 2 282 801	
24.0128-0207.2	428207		S	B	HC	V●	325,0	28,0	26,4	52,5	120,0	5	79,0	154,8	14,5	BMW	34 11 2 282 802	
24.0128-0208.2	428208		S	B	HC	V●	345,0	28,0	26,4	52,5	120,0	5	79,0		14,5	BMW	34 11 2 282 445	
24.0128-0209.2	428209		S	B	HC	V●	345,0	28,0	26,4	52,5	120,0	5	79,0		14,5	BMW	34 11 2 282 446	
24.0128-0210.1	428210		S	B	HC	V	336,0	28,0	26,0	52,0	108,0	5	63,5	152,0	16,0	VOLVO	30769057	
24.0128-0211.1	428211		B			V	274,0	28,3	26,0	50,6	114,3	5	72,0	140,0	13,0	KIA	0K58B-33-251	
24.0128-0212.1	428212					V	296,0	28,0	26,0	49,5	114,3	5	62,0	141,3	14,5	TOYOTA	43512-48011	
24.0128-0213.1	428213		B			V	280,0	28,0	25,9	71,5	118,0	5	73,0	142,0	15,5	CITROEN	4249 K2 16 078 721 80	
																FIAT	51705749 51740246 51848621	
24.0128-0214.1	428214		S	B		V	280,0	28,0	26,0	48,0	108,0	5	71,1	152,0	13,2	PEUGEOT	4249 K2 16 078 721 80	
																CITROEN	4249 J9	
																FIAT	9467548387	
																PEUGEOT	4249 J9	
																TOYOTA	SU001-A1063	
24.0128-0215.1	428215		B			V	332,0	28,0	26,0	56,3	139,7	6	94,0	171,0	12,8	TOYOTA	4615A038	

Abmessungen Bremsscheiben

Dimensions brake discs - Misure dischi freno -

Dimensions Disques de frein - Medidas disco de freno

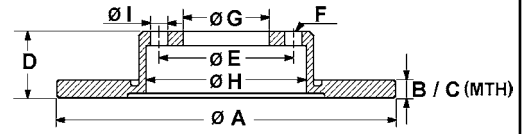

S Fixierschraube - fixing screw - vite di riparazione - vis de fixation - tornillo quefija

B beschichtet - coated - rivestito - revêtu - recubierto

HC hochgekohlt - high carbon - ad alto tenore di carbonio - à haute teneur en carbone - altamente carbonizado

L legiert - alloyed - alligato/legato - allié - aleado

V ventiliert - ventilated - ventilato - ventilé - ventilado

● gelocht - perforated - perforato - poinçonné - perforado

		S	B	HC	L	V	A	B	C	D	E	F	G	H	I	OE - #
24.0128-0216.1	428216	S	B			V	304,0	28,0	26,0	48,0	108,0	5	71,0	145,5	13,2	CITROEN 4249 25 4249 K0 16 118 419 80 FIAT 9467548587 9467548588 PEUGEOT 4249 24 4249 K0 TOYOTA SU001-A1064
24.0128-0217.1	428217	S	B			V	293,0	28,0	26,0	47,1	114,3	5	64,1	155,0	12,7	HONDA 45251-T1E-G01
24.0128-0219.1	428219	B				V	305,0	28,0	26,0	44,7	100,0	4	60,0	139,0	14,2	FIAT 51822457
24.0128-0220.1	428220	B				V	300,0	28,0	26,0	54,0	139,6	6	96,3	163,0	12,5	KIA 51712-4D200
24.0128-0223.1	428223	S	B	HC		V	312,5	28,0	26,0	63,0	100,0	5	61,0	151,0	15,5	RENAULT 77 01 208 130
24.0128-0224.1	428224	B				V	303,5	28,0	26,4	42,7	108,0	6	87,0	147,0	10,6	HYUNDAI 51712-H1030
24.0128-0226.1	428226	B	HC	L		V	289,0	28,0	26,0	70,2	140,0	6	98,0	164,0	13,0	FORD 1490412 6M34-1027-DA UR61-33-251
24.0128-0227.1	428227	B				V	302,0	28,0	26,4	54,0	139,6	5	96,3	163,0	12,5	MAZDA 51712-3E500
24.0128-0228.1	428228	B				V	295,6	28,0	26,0	48,2	114,3	5	72,0	142,8	13,0	MAZDA L206-33-25XA
24.0128-0229.1	428229	B				V	325,0	28,3	26,0	49,5	120,7	5	73,8	155,0	13,5	JAGUAR JLM 20617
24.0128-0231.1	428231	B	HC			V	305,0	28,0	26,0	44,8	98,0	4	59,0	139,0	13,2	FIAT 51738833 51813785
24.0128-0232.1	428232	B				V	296,0	28,0	25,0	49,2	114,3	5	62,0	154,0	14,5	TOYOTA 43512-28190
24.0128-0233.1	428233	B				V	320,0	28,0	26,0	48,2	114,3	5	72,0	143,0	13,0	MAZDA EH14-33-25XA
24.0128-0234.1	428234	B				V	300,0	28,0	26,4	47,3	114,3	5	69,0	141,5	12,5	HYUNDAI 51712-2L500
24.0128-0238.1	428238	B				V	300,0	28,0	25,0	74,5	125,0	6	78,0	156,0	15,5	IVECO 2996131
24.0128-0239.1	428239	B				V	290,0	28,0	25,0	46,0	95,0	9	64,0	123,0	12,5	IVECO 2996121
24.0128-0240.1	428240	B	HC	L		V	320,0	28,0	26,0	38,0	114,3	5	68,0	175,0	12,8	NISSAN 40206-EB320 40206-3X00B 40206-5X00A
24.0128-0241.1	428241	B	HC	L		V	296,0	28,0	26,0	38,0	114,3	6	68,0	161,0	12,8	NISSAN 40206-EB300
24.0128-0242.1	428242	B				V	320,0	28,0	26,0	44,0	114,3	5	68,0	146,5	12,7	NISSAN 40206-ET01A
24.0128-0243.1	428243	B	HC	L		V	305,0	28,0	26,0	44,7	98,0	4	59,0	191,0	13,0	RENAULT 40 20 698 28R
24.0128-0244.1	428244	B	HC	L		V	276,0	28,0	26,0	45,2	118,0	5	94,0	151,5	M12x1,5	FIAT 51817217
24.0128-0245.1	428245	S	B	HC	L	V	320,0	28,0	25,4	44,0	114,3	5	68,0	147,7	15,8	NISSAN 40206-MB600
24.0128-0246.1	428246	B	HC	L		V●	330,0	28,0	26,0	69,0	130,0	5	98,0	159,7	15,4	RENAULT 50 01 871 213
24.0128-0247.1	428247	B	HC	L		V●	330,0	28,0	26,0	69,0	130,0	5	98,0	159,7	15,4	RENAULT 40 20 600 03R 40 20 641 55R
24.0128-0248.1	428248	B	HC	L		V	321,0	28,0	26,4	49,1	114,3	5	69,0	143,0	12,5	PORSCHE 997 351 402 00 997 351 402 01 997 351 401 00 997 351 401 01
24.0128-0249.1	428249	B				V	258,0	28,0	26,0	58,6	114,3	5	62,0	141,0	14,5	HYUNDAI 51712-2P700 51712-2W700
24.0128-0250.1	428250	B	HC			V	300,0	28,0	26,0	52,0	108,0	5	63,5	140,0	13,8	KIA 51712-2P700
24.0128-0251.1	428251	B	HC			V	303,0	28,0	26,0	56,9	120,0	5	76,0	165,2	16,6	TOYOTA 43512-0K010 43512-0K030
24.0128-0252.1	428252	S	B			V	302,0	28,0	24,5	69,9	130,0	5	90,0	160,5	17,4	FORD 1500159 7G91-1125-EA
24.0128-0253.1	428253	B	HC	L		V	305,0	28,0	26,0	45,7	98,0	5	59,2	127,0	13,0	VOLKSWAGEN 2H0 615 301 A
24.0128-0254.1	428254	S	B	HC		V	328,0	28,0	26,4	73,1	120,0	5	75,0	153,8	16,5	NISSAN 40206-00Q0G
24.0128-0255.1	428255	B				V	350,0	28,0	26,0	68,1	127,0	5	72,0	205,0	16,2	OPEL/VAUXHALL 44 19 359/93197403
24.0128-0256.1	428256	B	HC	L		V	300,0	28,0	26,4	47,3	114,3	5	69,0	142,5	12,5	RENAULT 82 00 688 880
24.0128-0258.1	428258	B	HC	L		V	320,0	28,1	26,4	47,3	114,3	5	69,0	145,0	12,5	FIAT 51897455 51914663
24.0128-0260.1	428260	B	HC	L		V●	315,0	28,0	26,0	69,0	130,0	5	98,0	159,0	15,4	OPEL/VAUXHALL 5 69 087/95511283
24.0128-0262.1	428262	S	B	HC	L	V●	295,0	28,0	26,0	51,1	112,0	5	67,0	154,6	15,0	BMW 34 10 6 787 490
24.0128-0263.1	428263	B	HC			V	302,0	28,0	26,4	38,2	127,0	5	72,5	166,0	14,0	JEEP 5290 731AB
24.0128-0264.1	428264	B	HC	L		V●	350,0	28,0	26,0	75,0	130,0	5	98,0	180,0	15,4	HYUNDAI 51712-3K150
24.0128-0265.1	428265	B	HC	L		V●	350,0	28,0	26,0	75,0	130,0	5	98,0	180,0	15,4	KIA 51712-3K160 51712-3K160 51712-2Y000
24.0128-0269.1	428269	S	B	HC		V	304,0	28,0	26,0	48,0	108,0	5	71,0	133,2	13,2	HYUNDAI 51712-2T100
24.0128-0273.1	428273	B	HC	L		V●	315,0	28,0	26,0	69,0	130,0	5	98,0	159,0	15,4	PORSCHE 981 351 402 01
24.0128-0275.1	428275	S	B	HC	L	V	295,0	28,0	25,4	51,1	112,0	5	67,0	154,6	15,0	MERCEDES BENZ 246 421 25 12
24.0128-0276.1	428276	S	B	HC	L	V	295,0	28,0	25,4	51,0	112,0	5	67,0	155,0	15,0	CHRYSLER 0 6803 2944AB 6803 2944AB K68032944AB
		B	HC	L		V●	350,0	28,0	26,0	75,0	130,0	5	98,0	180,0	15,4	FIAT K68032944AB
		B	HC	L		V●	350,0	28,0	26,0	75,0	130,0	5	98,0	180,0	15,4	PORSCHE 997 352 406 02
		S	B	HC		V	304,0	28,0	26,0	48,0	108,0	5	71,0	133,2	13,2	PORSCHE 997 352 405 02
		B	HC	L		V●	315,0	28,0	26,0	69,0	130,0	5	98,0	159,0	15,4	CITROEN/PEUGEOT 4249 K1
		S	B	HC	L	V	295,0	28,0	25,4	51,1	112,0	5	67,0	154,6	15,0	PORSCHE 981 351 401 01
		S	B	HC	L	V	295,0	28,0	25,4	51,0	112,0	5	67,0	155,0	15,0	MERCEDES BENZ 246 421 24 12
		S	B	HC	L	V	295,0	28,0	25,4	51,0	112,0	5	67,0	155,0	15,0	MERCEDES BENZ 246 421 01 12

Abmessungen Bremsscheiben

Dimensions brake discs - Misure dischi freno -

Dimensions Disques de frein - Medidas disco de freno

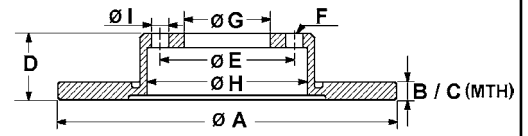

S Fixierschraube - fixing screw - vite di riparazione - vis de fixation - tornillo quejija
 B beschichtet - coated - rivestito - revêtu - recubierto
 HC hochgekohlt - high carbon - ad alto tenore di carbonio - à haute teneur en carbone - altamente carbonizado
 L legiert - alloyed - alligato/legato - allié - aleado
 V ventiliert - ventilated - ventilato - ventilé - ventilado
 ● gelocht - perforated - perforato - poinçonné - perforado

		S	B	HC	L	V	A	B	C	D	E	F	G	H	I	OE - #	
24.0128-0282.1	428282		B	HC	L	V	330,0	28,0	26,0	75,0	130,0	5	98,0	180,0	15,4	PORSCHE	970 352 403 00 298 615 601 A
24.0128-0283.1	428283		B	HC	L	V	330,0	28,0	26,0	75,0	130,0	5	98,0	180,0	15,4	PORSCHE	970 352 404 00 298 615 602 A
24.0128-0708.1	428708			HC		V	288,0	28,0	26,0	64,8	114,3	5	72,0	158,0	15,5	JEEP	5212 8247AA 5212 8247AB 5212 8247AC
24.0128-0722.1	428722					V	282,0	28,0	26,0	47,0	114,3	5	70,2	148,2	12,6	HONDA	45251-SP0-E00
24.0128-0740.1	428740		B			V	296,0	28,0	26,0	49,2	114,3	5	62,0	149,0	14,5	LEXUS	43512-30310
24.0128-0753.1	428753		B			V	319,0	28,0	26,0	49,3	114,3	5	62,0	178,5	14,7	LEXUS	43512-48080 43512-48081 43512-48100
24.0129-0100.1	429100		B			V	305,0	28,5	26,0	49,5	120,7	5	73,8	154,5	13,4	JAGUAR	JLM 20150
24.0129-0101.1	429101		B	HC	L	V	296,0	29,0	27,5	51,6	115,0	5	70,7	154,5	12,8	CHEVROLET	96625948 20955857 4801850
24.0129-0102.1	429102		S	B	HC	V	345,0	29,5	28,0	52,1	112,0	5	68,0	154,0	15,3	OPEL/VAUXHALL	48 08 848/96625948
24.0130-0100.1	430100		B	HC	L	V	320,0	30,0	27,4	82,0	112,0	5	67,0	154,3	15,2	AUDI MERCEDES BENZ	8K0 615 301 M 140 421 09 12 140 421 10 12
24.0130-0101.1	430101		S	B	HC	V	324,0	30,0	28,4	77,0	120,0	5	79,0	149,0	14,5	BMW	34 11 6 757 746
24.0130-0103.1	430103			HC	L	V	324,0	30,0	26,0	91,0	140,0	6	118,0	122,0	M12x1,5	MERCEDES BENZ	668 421 02 12 670 421 03 12
24.0130-0104.1	430104		B	HC		V	314,0	30,0	28,0	59,7	112,0	5/10	68,0	136,0	15,3	AUDI	441 615 301 AA
24.0130-0105.1	430105					V	322,0	30,0	27,4	126,0	205,0	6	148,0	178,0	21,0	FORD	6172906
24.0130-0107.1	430107		S	B	HC	V	324,0	29,9	28,4	73,7	120,0	5	79,0	149,0	14,8	BMW	34 11 6 767 059
24.0130-0109.1	430109		S	B	HC	V	332,0	29,9	28,4	62,1	120,0	5	75,0	158,0	16,5	BMW	34 11 6 766 036 34 11 6 859 679
24.0130-0113.1	430113		B	HC		V	320,0	30,0	28,0	46,5	112,0	5/9	68,0	137,0	15,3	AUDI	8D0 615 301 M 8E0 615 301 AD
24.0130-0114.1	430114		B	HC		V	308,0	29,5	25,5	55,6	120,0	5	76,0	154,6	16,6	VOLKSWAGEN	7E0 615 301 D JZW 615 301 E
24.0130-0115.1	430115		B	HC		V	345,0	30,0	27,0	49,9	112,0	5/9	65,0	140,0	15,3	AUDI/SKODA/VW	1K0 615 301 M
24.0130-0116.1	430116		B	HC		V	336,0	30,0	27,0	51,0	108,0	5	68,0	150,0	16,5	VOLVO	30657301
24.0130-0117.1	430117		B	HC		V	324,0	30,0	28,4	81,0	120,0	5	79,0	169,0	16,5	BMW	34 11 6 750 265
24.0130-0118.1	430118		B	HC		V	348,0	30,0	28,4	81,0	120,0	5	79,0	164,0	16,5	BMW	34 11 6 750 267 34 11 6 864 057
24.0130-0119.1	430119		B	HC		V	345,0	30,0	28,0	46,5	112,0	5/9	68,0	142,0	15,3	AUDI	8E0 615 301 K 8E0 615 301 T
24.0130-0120.1	430120		B			V	300,0	30,0	28,0	43,0	108,0	5	71,0	143,5	14,0	JAGUAR	JLM 20801
24.0130-0121.1	430121		B	HC	L	V	320,0	30,0	28,0	50,5	112,0	5	67,0	154,0	13,0	MERCEDES BENZ	129 421 15 12 129 421 17 12
24.0130-0122.1	430122		B	HC	L	V	320,0	30,0	28,0	50,5	112,0	5	67,0	154,0	13,0	MERCEDES BENZ	129 421 16 12 129 421 18 12
24.0130-0171.1	430171		B	HC	L	V	345,0	30,0	27,4	46,5	112,0	5	67,0	154,0	13,0	MERCEDES BENZ	209 421 00 12
24.0130-0172.1	430172		B	HC	L	V●	304,0	30,0	27,4	47,5	112,0	5	67,0	154,0	15,0	MERCEDES BENZ	220 421 17 12
24.0130-0173.1	430173		S	B	HC	V	324,0	30,0	28,4	77,0	120,0	5	79,0	165,0	14,5	BMW	34 11 6 753 221
24.0130-0174.1	430174			HC		V	321,0	30,0	28,0	52,5	112,0	5/10	68,0	135,0	15,3	AUDI	4B3 615 301
24.0130-0175.1	430175		S	B	HC	V	321,0	30,0	28,0	59,7	112,0	5	68,0	144,8	15,3	AUDI	4F0 615 301 E
24.0130-0176.1	430176		S	B	HC	V	347,0	30,0	28,0	59,7	112,0	5	68,0	158,0	15,3	AUDI	4F0 615 301 G
24.0130-0177.1	430177		B	HC		V	345,0	30,0	28,0	59,7	112,0	5/10	68,0	135,0	15,3	AUDI	4D0 615 301 B
24.0130-0178.1	430178		B			V	317,0	30,0	27,0	62,0	120,0	5	79,0	165,0	15,0	LAND ROVER	SDB000602 SDB000603 SDB000604
24.0130-0179.1	430179		B	HC	L	V	304,0	30,0	27,4	41,0	112,0	5	67,0	154,0	15,0	MERCEDES BENZ	211 421 12 12
24.0130-0180.1	430180		B	HC	L	V●	345,0	30,0	28,0	46,5	112,0	5	67,0	154,2	13,1	MERCEDES BENZ	203 421 09 12
24.0130-0181.1	430181		S	B		V	330,0	30,0	28,0	48,0	108,0	5	71,1	171,8	13,2	CITROEN	4246 K0 4249 44 4249 A9
24.0130-0182.1	430182		B			V	320,0	30,0	28,4	43,0	108,0	5	71,0	143,5	14,0	JAGUAR	C2C 8354
24.0130-0183.1	430183		B	HC		V	323,0	30,0	28,0	59,7	112,0	5/9	68,0	144,0	15,3	AUDI/VW	3D0 615 301 G 4D0 615 301 J
24.0130-0184.1	430184		B	HC		V	344,0	29,9	28,4	75,9	120,0	5	79,0	172,8	16,6	LAND ROVER	SDB000200 SDB000201
24.0130-0185.1	430185		B	HC		V●	320,0	30,0	28,0	46,5	112,0	5/9	68,0	137,0	15,3	AUDI	8E0 615 301 AE
24.0130-0186.2	430186		S	B	HC	V	348,0	30,0	28,4	77,1	120,0	5	79,0	187,3	14,5	BMW	34 11 6 763 824
24.0130-0187.1	430187		S	B	HC	V	340,0	30,0	28,0	49,9	112,0	5	65,0	140,0	15,3	AUDI	8J0 615 301
24.0130-0188.1	430188		B			V	337,5	30,0	27,0	62,0	120,0	5	79,0	166,0	15,0	LAND ROVER	SDB000612 SDB000613 SDB000614

Abmessungen Bremsscheiben

Dimensions brake discs - Misure dischi freno -

Dimensions Disques de frein - Medidas disco de freno

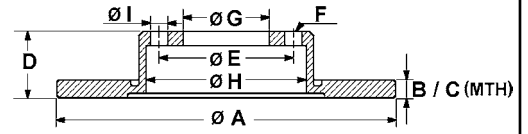

S Fixierschraube - fixing screw - vite di riparazione - vis de fixation - tornillo quejija
 L legiert - alloyed - alligato/legato - allié - aleado
 ● gelocht - perforated - perforato - poinçonné - perforado
 B beschichtet - coated - rivestito - revêtu - recubierto
 V ventiliert - ventilated - ventilato - ventilé - ventilado
 HC hochgekohlt - high carbon - ad alto tenore di carbonio - à haute teneur en carbone - altamente carbonizado

		S	B	H	C	L	V	A	B	C	D	E	F	G	H	I	OE - #	
24.0130-0189.1	430189		B		HC		V	345,0	29,9	27,5	45,3	110,0	5	70,0	142,4	14,2	OPEL/VAUXHALL SAAB	5 69 154/93188445 93188445
24.0130-0190.1	430190				HC	L	V	304,0	29,9	26,0	120,5	192,0	6	157,0	134,0	M12x1,5	MERCEDES BENZ	668 423 00 12
24.0130-0191.1	430191				HC	L	V	324,0	29,9	26,0	120,5	192,0	6	157,0	134,0	M12x1,5	MERCEDES BENZ	668 423 01 12
24.0130-0192.1	430192	S	B		HC		V	348,0	30,0	28,4	73,1	120,0	5	79,0	186,8	14,5	BMW	34 11 6 855 000
24.0130-0193.1	430193	S	B		HC		V	320,0	30,0	28,0	52,4	112,0	5	68,0	153,4	15,3	AUDI	8K0 615 301 A
24.0130-0195.1	430195		B				V	360,0	30,0	27,0	62,0	120,0	5	79,0	175,0	15,0	LAND ROVER	SDB000622 SDB000623 SDB000624
24.0130-0196.1	430196		B				V	344,0	30,0	27,0	76,0	120,0	5	79,0	172,0	16,6	LAND ROVER	SDB500181 SDB500182
24.0130-0197.1	430197		B				V	360,0	30,0	27,0	81,0	120,0	5	79,0	175,0	16,6	LAND ROVER	SDB500192 SDB500193
24.0130-0198.1	430198				HC	L	V	304,0	30,0	26,0	91,0	140,0	6	118,0	122,0	M12x1,5	MERCEDES BENZ	668 421 01 12 668 421 06 12
24.0130-0199.1	430199	S	B		HC		V	348,0	29,9	28,4	62,1	120,0	5	75,0	154,0	16,5	BMW	34 11 6 793 244 34 11 6 868 938
24.0130-0200.1	430200	S	B		HC		V	332,0	29,9	28,4	62,1	120,0	5	75,0	153,0	16,5	BMW	34 11 6 868 939
24.0130-0201.1	430201		B				V	334,0	30,0	27,0	51,0	114,3	5	62,0	143,5	14,5	LEXUS	43516-22010
24.0130-0202.1	430202		B				V	334,0	30,0	27,0	51,0	114,3	5	62,0	143,5	14,5	LEXUS	43512-22260
24.0130-0203.1	430203		B				V	326,0	30,0	28,0	52,7	114,3	5	58,0	148,0	12,8	SUBARU	26300FE070
24.0130-0204.1	430204		B				V	316,0	30,0	28,0	56,8	100,0	5	58,0	149,0	13,0	SUBARU	26300AG001
24.0130-0206.1	430206	S	B		HC	L	V	330,0	30,0	28,0	48,0	108,0	5	71,1	138,0	13,0	CITROEN PEUGEOT	4249 A7 4249 A7
24.0130-0207.1	430207	S	B		HC	L	V	296,0	30,0	27,0	51,0	120,0	5	67,4	163,7	16,3	CHEVROLET OPEL/VAUXHALL SAAB	13501307 5 69 078/13579147 13502213
24.0130-0208.1	430208	S	B		HC		V	337,0	30,0	27,0	51,0	120,0	5	67,4	159,7	16,3	OPEL/VAUXHALL SAAB	5 69 081/13579153 13576781
24.0130-0209.1	430209	S	B		HC		V	321,0	30,0	27,0	51,0	120,0	5	67,4	160,0	16,3	CHEVROLET OPEL/VAUXHALL SAAB	13501320, 135799150 5 69 083/135799150 135799150
24.0130-0212.1	430212		B		HC		V	328,0	30,0	28,0	52,0	108,0	5	63,5	165,5	15,7	VOLVO	31277342
24.0130-0213.2	430213	S	B		HC		V●	360,0	30,0	28,4	62,3	120,0	5	79,0	185,0	14,5	BMW	34 11 2 283 802
24.0130-0214.2	430214	S	B		HC		V●	360,0	30,0	28,4	62,3	120,0	5	79,0	185,0	14,5	BMW	34 11 2 283 801
24.0130-0215.1	430215		B		HC		V	324,0	30,0	28,4	49,0	114,3	5	68,0	152,0	12,7	NISSAN	40206-CD005
24.0130-0216.2	430216	S	B		HC		V	348,0	30,0	28,4	73,0	120,0	5	79,0	186,8	14,5	BMW	34 11 6 782 593
24.0130-0217.1	430217	S	B		HC	L	V	315,0	30,0	27,4	83,0	130,0	5	85,0	157,0	15,0	MERCEDES BENZ	463 421 00 12 463 421 01 12 463 421 03 12
24.0130-0218.2	430218	S	B		HC		V	348,0	30,0	28,4	66,0	120,0	5	75,0	186,8	16,5	BMW	34 11 6 775 277
24.0130-0219.1	430219	S	B		HC		V	340,0	30,0	28,0	49,5	112,0	5	65,0	139,7	15,3	AUDI	8J0 615 301 G
24.0130-0220.1	430220	S	B		HC		V	314,0	30,0	27,0	49,6	112,0	9	65,0	145,0	15,3	SEAT/VW	1K0 615 301 AJ
24.0130-0221.1	430221	S	B		HC		V	320,0	30,0	28,0	52,2	112,0	5	68,0	149,3	15,3	AUDI	8R0 615 301
24.0130-0222.1	430222	S	B		HC		V	345,0	30,0	28,0	52,1	112,0	5	68,0	164,6	15,3	AUDI	4G0 615 301 4G0 615 301 G 95B 615 301 B 0 5208 9269AB 5208 9269AB
24.0130-0223.1	430223		B				V	328,0	30,0	28,5	53,0	127,0	5	72,0	177,0	16,2	PORSCHE JEEP JEEP	5208 9269AB
24.0130-0224.1	430224	S	B		HC		V	321,0	30,0	27,0	45,5	115,0	5	70,7	160,0	14,2	OPEL/VAUXHALL	5 69 092/13586854
24.0130-0225.1	430225	S	B		HC		V	340,0	30,0	27,0	49,6	112,0	5/9	65,0	145,0	15,3	AUDI AUDI/SEAT/SKODA/VW	8S0 615 301 1K0 615 301 AD 3C0 615 301 C
24.0130-0226.1	430226		B		HC		V	326,0	30,0	28,0	46,0	108,0	5	71,0	161,0	14,0	JAGUAR	C2C 25336
24.0130-0227.1	430227	S	B		HC	L	V	340,0	30,0	28,0	48,0	108,0	5	71,1	136,0	13,2	CITROEN/PEUGEOT	4249 88
24.0130-0230.1	430230	S	B		HC	L	V	340,0	30,0	28,0	34,2	108,0	4	71,1	133,0	13,2	CITROEN/PEUGEOT	4249 F6 16 118 414 80
24.0130-0233.2	430233	S	B		HC		V	340,0	30,0	28,4	73,2	120,0	5	79,0	153,7	16,5	BMW	34 11 6 792 223
24.0130-0234.2	430234	S	B		HC		V	370,0	30,0	28,4	73,1	120,0	5	79,0	184,0	16,5	BMW	34 10 6 797 606
24.0130-0237.1	430237	S	B		HC	L	V	320,0	30,0	28,0	51,0	112,0	5	67,0	154,0	15,0	MERCEDES BENZ	246 421 26 12
24.0130-0238.1	430238	S	B		HC	L	V●	320,0	30,0	28,0	51,0	112,0	5	67,0	154,0	15,0	MERCEDES BENZ	246 421 27 12
24.0132-0100.1	432100	S	B		HC	L	V●	322,0	32,0	30,0	64,5	112,0	5	67,0	154,3	15,2	MERCEDES BENZ	000 421 11 12 204 421 10 12 000 421 30 12 000 421 12 12
24.0132-0101.1	432101	S	B		HC	L	V	322,0	32,0	29,4	64,5	112,0	5	67,0	154,3	15,2	MERCEDES BENZ	000 421 12 12
24.0132-0110.1	432110						V	278,0	32,2	30,7	52,0	118,0	5	70,6	150,0	16,2	OPEL/VAUXHALL	5 69 019/9195293
24.0132-0111.1	432111						V	311,0	32,0	30,0	58,0	139,7	6	105,0	204,0	M12x1,25	TOYOTA	43512-60090
24.0132-0113.1	432113	S	B		HC		V	334,0	31,9	30,4	76,9	120,0	5	79,0	159,0	14,8	BMW	34 11 6 757 756
24.0132-0114.1	432114		B		HC		V	345,0	31,9	30,0	51,0	112,0	5	67,0	156,5	15,3	MERCEDES BENZ	163 421 05 12
24.0132-0115.1	432115		B		HC	L	V●	330,0	32,0	30,0	76,0	112,0	5	67,0	154,0	15,0	MERCEDES BENZ	220 421 25 12
24.0132-0116.1	432116		B		HC		V	333,0	32,5	28,5	55,6	120,0	5	76,0	154,6	16,6	VOLKSWAGEN	7H0 615 301 F
24.0132-0117.1	432117		B		HC	L	V	330,0	32,0	30,0	68,5	130,0	5	85,0	174,0	15,4	PORSCHE VOLKSWAGEN	955 351 401 40 955 351 401 41 7L6 615 301 N



Abmessungen Bremsscheiben

Dimensions brake discs - Misure dischi freno -

Dimensions Disques de frein - Medidas disco de freno

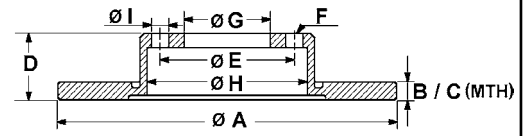

S Fixierschraube - fixing screw - vite di riparazione - vis de fixation - tornillo quejija

B beschichtet - coated - rivestito - revêtu - recubierto

HC hochgekohlt - high carbon - ad alto tenore di carbonio - à haute teneur en carbone - altamente carbonizado

L legiert - alloyed - alligato/legato - allié - aleado

V ventiliert - ventilated - ventilato - ventilé - ventilado

● gelocht - perforated - perforato - poinçonné - perforado

		S	B	HC	L	V	A	B	C	D	E	F	G	H	I	OE	- #
24.0132-0118.1	432118		B	HC	L	V	330,0	32,0	30,0	68,5	130,0	5	85,0	174,0	15,4	PORSCHE	955 351 402 40 955 351 402 41
24.0132-0125.1	432125		B	HC	L	V●	345,0	32,0	30,0	76,0	112,0	5	67,0	154,0	15,0	VOLKSWAGEN	7L6 615 302 N
24.0132-0126.1	432126					V	310,0	32,0	30,0	43,8	98,0	5	59,0	138,0	16,5	MERCEDES BENZ	220 421 11 12
																CITROEN	4249 A8 4249 F2
																FIAT	1355376080 9464640587
24.0132-0127.1	432127			HC	L	V	282,0	32,0	30,6	60,0	130,0	5	90,0	156,0	15,4	PEUGEOT	4249 A8
24.0132-0128.1	432128			HC	L	V	282,0	32,0	30,6	60,0	130,0	5	90,0	156,0	15,4	PORSCHE	928 351 043 01
24.0132-0129.1	432129			HC		V	330,0	32,0	30,0	44,7	98,0	5	59,0	149,0	13,0	PORSCHE	928 351 044 01
24.0132-0131.1	432131		B			V	300,0	32,0	29,9	73,5	130,0	5	80,0	161,0	18,0	ALFA ROMEO	51768587
																CITROEN	4249 38 4249 A6
																FIAT	16 078 723 80 51705758 51740249
																PEUGEOT	4249 37 4249 A6 16 078 723 80
24.0132-0136.1	432136		B	HC	L	V●	330,0	32,0	30,0	47,5	112,0	5	67,0	154,0	15,0	MERCEDES BENZ	220 421 18 12
24.0132-0137.1	432137	S	B	HC	L	V●	335,0	32,0	30,0	64,5	112,0	5	67,0	154,0	15,2	MERCEDES BENZ	221 421 17 12
24.0132-0138.1	432138	S	B	HC	L	V●	350,0	32,0	30,0	64,5	112,0	5	67,0	154,0	15,2	MERCEDES BENZ	221 421 00 12 221 421 16 12
24.0132-0139.1	432139	S	B	HC	L	V	350,0	32,0	29,4	64,5	112,0	5	67,0	154,0	15,2	MERCEDES BENZ	219 421 01 12
24.0132-0140.1	432140		B	HC	L	V●	304,0	32,0	30,6	56,7	126,0	5	107,0	172,0	8,4	PORSCHE	930 351 047 02
24.0132-0142.1	432142		B	HC	L	V●	304,0	32,0	30,0	72,0	130,0	5	103,0	161,0	15,4	PORSCHE	993 351 043 01
24.0132-0143.1	432143		B	HC	L	V●	304,0	32,0	30,0	72,0	130,0	5	103,0	161,0	15,4	PORSCHE	993 351 044 01
24.0132-0144.1	432144	S	B	HC	L	V	330,0	32,0	29,4	64,5	112,0	5	67,0	154,0	15,0	MERCEDES BENZ	204 421 29 12 211 421 10 12 211 421 13 12 211 421 14 12
24.0132-0146.1	432146		B	HC	L	V●	304,0	32,0	30,6	56,7	126,0	5	107,0	172,0	8,4	PORSCHE	930 351 048 02
24.0132-0147.1	432147		B	HC	L	V●	334,0	32,0	30,0	51,5	112,0	5	67,0	154,0	13,0	MERCEDES BENZ	129 421 23 12
24.0132-0148.1	432148		B			V	313,0	32,0	30,0	70,0	144,0	5	115,0	172,5	12,5	LEXUS/TOYOTA	43512-60130 43512-60170
24.0132-0150.1	432150		B	HC	L	V	304,0	32,0	30,0	77,0	130,0	5	103,0	161,0	15,4	PORSCHE	928 351 044 03 928 351 044 60
24.0132-0151.1	432151		B	HC	L	V	304,0	32,0	30,0	77,0	130,0	5	103,0	161,0	15,4	PORSCHE	928 351 043 03 928 351 043 60
24.0132-0152.1	432152					V	309,0	32,0	30,0	43,1	108,0	5	71,1	136,0	13,0	PEUGEOT	4246 V5
24.0132-0153.1	432153	S	B	HC	L	V●	330,0	32,0	30,0	64,5	112,0	5	67,0	154,0	15,0	MERCEDES BENZ	230 421 08 12
24.0132-0154.1	432154		B	HC	L	V	330,0	32,0	29,4	47,5	112,0	5	67,0	154,0	15,0	MERCEDES BENZ	211 421 11 12
24.0132-0157.1	432157	S	B	HC	L	V	350,0	32,0	29,4	54,5	112,0	5	67,0	156,3	15,2	MERCEDES BENZ	164 421 05 12 164 421 14 12
24.0132-0158.1	432158	S	B	HC	L	V	330,0	32,0	29,4	54,5	112,0	5	67,0	156,3	15,2	MERCEDES BENZ	164 421 04 12 164 421 13 12
24.0132-0159.1	432159		B	HC	L	V	330,0	32,0	29,4	46,5	112,0	5	67,0	154,0	13,0	CHRYSLER	5135 475AA
24.0132-0160.1	432160	S	B	HC		V	334,0	31,9	30,4	62,9	120,0	5	79,0	159,0	14,8	MERCEDES BENZ	210 421 23 12
24.0132-0161.2	432161	S	B	HC		V	345,0	32,0	30,4	77,0	120,0	5	79,0	159,5	14,5	BMW	34 11 1 165 072
24.0132-0162.2	432162	S	B	HC		V	345,0	32,0	30,4	77,0	120,0	5	79,0	159,5	14,5	BMW	34 11 2 282 803
24.0132-0163.2	432163		B	HC	L	V●	322,0	32,0	30,0	72,0	130,0	5	103,0	157,0	15,4	PORSCHE	993 351 045 10
24.0132-0164.2	432164		B	HC	L	V●	322,0	32,0	30,0	72,0	130,0	5	103,0	157,0	15,4	PORSCHE	993 351 046 10
24.0132-0165.2	432165		B	HC		V	334,0	32,0	30,0	35,0	100,0	5/9	65,0	146,0	15,6	AUDI	8N0 615 302 B
24.0132-0166.2	432166		B	HC		V	334,0	32,0	30,0	35,0	100,0	5/9	65,0	146,0	15,6	VOLKSWAGEN	1J0 615 302 A
																AUDI	8N0 615 301 B
24.0132-0167.1	432167	S	B	HC	L	V	375,0	32,0	29,4	54,5	112,0	5	67,0	156,3	15,2	VOLKSWAGEN	1J0 615 301 AA
24.0132-0169.1	432169		B	HC		V	321,0	32,0	30,0	51,0	114,3	5	69,0	143,0	12,5	MERCEDES BENZ	164 421 15 12
24.0132-0170.1	432170	S	B	HC	L	V●	322,0	32,0	30,0	51,5	112,0	5	67,0	154,2	15,2	HYUNDAI	51712-3J500
24.0132-0172.1	432172	S	B	HC		V	320,0	32,0	30,0	47,2	114,3	5	64,2	151,0	12,6	MERCEDES BENZ	000 421 18 12 218 421 03 12
24.0132-0178.1	432178	S	B	HC	L	V	330,0	32,0	29,4	54,5	112,0	5	67,0	158,0	15,0	HONDA	45251-TL0-G51
24.0132-0179.1	432179	S	B	HC	L	V●	350,0	32,0	29,4	54,0	112,0	5	67,0	158,0	15,0	MERCEDES BENZ	166 421 06 12 166 421 10 12
24.0132-0701.1	432701		B			V	296,0	32,0	30,0	50,8	114,3	5	62,0	143,5	14,5	MERCEDES BENZ	43512-30180 43512-30181 43512-50100 43512-50110 43512-53010 43512-53020
24.0133-0100.1	433100	S	B	HC		V	340,0	32,6	29,5	55,6	120,0	5	76,0	154,8	16,6	VOLKSWAGEN	7E0 615 301 C
24.0134-0100.1	434100		B	HC		V	360,0	34,0	31,0	59,7	112,0	5	68,0	135,0	15,0	AUDI/VW	3D0 615 301 F 4E0 615 301 P



Abmessungen Bremsscheiben

Dimensions brake discs - Misure dischi freno -

Dimensions Disques de frein - Medidas disco de freno

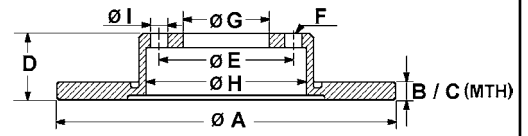

S Fixierschraube - fixing screw - vite di riparazione - vis de fixation - tornillo quefija
 B beschichtet - coated - rivestito - revêtu - recubierto
 HC hochgekohlt - high carbon - ad alto tenore di carbonio - à haute teneur en carbone - altamente carbonizado
 L legiert - alloyed - alligato/legato - allié - aleado
 V ventiliert - ventilated - ventilato - ventilé - ventilado
 ● gelocht - perforated - perforato - poinçonné - perforado

		S	B	HC	L	V	A	B	C	D	E	F	G	H	I	OE - #
24.0134-0101.1	434101		B	HC	L	V●	330,0	34,0	32,0	69,5	130,0	5	98,0	173,5	15,4	PORSCHE 996 351 409 02 996 351 409 03
24.0134-0102.1	434102		B	HC	L	V●	330,0	34,0	32,0	69,5	130,0	5	98,0	173,5	15,4	PORSCHE 996 351 410 02 996 351 410 03
24.0134-0103.1	434103	S	B	HC		V	356,0	34,0	31,5	52,4	112,0	5	68,0	149,0	15,3	AUDI 4G0 615 301 A
24.0134-0105.1	434105		B	HC	L	V●	350,0	34,0	32,0	67,5	130,0	5	98,0	185,0	15,4	PORSCHE 997 351 409 90
24.0134-0106.1	434106		B	HC	L	V●	350,0	34,0	32,0	67,5	130,0	5	98,0	185,0	15,4	PORSCHE 997 351 410 90
24.0134-0123.1	434123		B	HC	L	V	350,0	34,0	32,0	68,5	130,0	5	85,0	185,0	15,4	AUDI/VW 7L6 615 301 K 7L8 615 301
																PORSCHE 995 351 40 150 955 351 401 51
24.0134-0124.1	434124		B	HC	L	V	350,0	34,0	32,0	68,5	130,0	5	85,0	185,0	15,4	AUDI/VW 7L6 615 302 K 7L8 615 302
																PORSCHE 995 351 40 250 955 351 402 51
24.0136-0101.1	436101		B	HC		V	374,0	36,0	34,4	81,0	120,0	5	79,0	187,0	16,5	BMW 34 11 6 766 107
24.0136-0102.1	436102		B	HC	L	V●	360,0	36,0	34,0	64,5	112,0	5	67,0	154,0	15,2	MERCEDES BENZ 221 421 18 12
24.0136-0103.1	436103		B	HC		V	385,0	36,0	33,5	59,7	112,0	5	68,0	135,0	15,3	AUDI 4E0 615 301 K
24.0136-0104.1	436104		B	HC		V	356,0	36,0	34,4	61,9	120,0	5	75,0	158,0	16,5	BMW 34 11 6 756 847
24.0136-0105.1	436105		B	HC	L	V●	360,0	36,0	34,0	76,0	112,0	5	67,0	154,0	15,0	MERCEDES BENZ 220 421 19 12
24.0136-0106.2	436106	S	B	HC		V	348,0	36,0	34,4	77,0	120,0	5	79,0	154,3	14,5	BMW 34 11 6 766 871 34 11 6 779 467
24.0136-0107.1	436107		B	HC		V	385,0	36,0	33,5	61,4	112,0	5	68,0	135,0	15,2	AUDI 4F0 615 301 J
24.0136-0108.1	436108	S	B	HC	L	V●	360,0	36,0	34,0	64,5	112,0	5	67,0	154,0	15,2	MERCEDES BENZ 000 421 20 12 221 421 08 12
24.0136-0109.1	436109	S	B	HC		V	365,0	36,0	34,4	62,0	120,0	5	75,0	168,0	16,5	BMW 34 11 6 793 243
24.0136-0110.1	436110		B	HC		V	348,0	35,9	34,4	80,9	120,0	5	79,0	154,0	16,5	BMW 34 11 6 767 353
24.0136-0111.1	436111		B	HC		V	368,0	36,0	34,0	68,7	130,0	5	85,0	157,0	15,4	PORSCHE 955 351 403 00
24.0136-0112.2	436112	S	B	HC		V	385,0	36,0	34,4	62,0	120,0	5	75,0	153,7	16,5	VOLKSWAGEN 7L8 615 301 A
24.0136-0113.2	436113	S	B	HC		V	385,0	36,0	34,4	62,0	120,0	5	75,0	153,7	16,5	BMW 34 11 6 782 068
24.0136-0114.2	436114	S	B	HC		V	348,0	36,0	34,4	66,0	120,0	5	75,0	153,7	16,5	BMW 34 11 6 785 670
24.0136-0115.2	436115	S	B	HC		V	348,0	36,0	34,4	66,0	120,0	5	75,0	153,7	16,5	BMW 34 11 6 785 669
24.0136-0116.2	436116	S	B	HC		V●	374,0	36,0	34,4	77,0	120,0	5	79,0	174,0	14,5	BMW 34 11 2 282 806
24.0136-0117.2	436117	S	B	HC		V●	374,0	36,0	34,4	77,0	120,0	5	79,0	174,0	14,5	BMW 34 11 2 282 805
24.0136-0118.2	436118	S	B	HC		V	374,0	36,0	34,4	66,0	120,0	5	75,0	186,8	16,5	BMW 34 11 6 785 676
24.0136-0119.2	436119	S	B	HC		V	374,0	36,0	34,4	66,0	120,0	5	75,0	186,8	16,5	BMW 34 11 6 785 675
24.0136-0120.2	436120	S	B	HC		V	374,0	36,0	34,4	66,0	120,0	5	75,0	153,8	16,5	BMW 34 11 6 789 544
24.0136-0121.2	436121	S	B	HC		V	374,0	36,0	34,4	66,0	120,0	5	75,0	153,8	16,5	BMW 34 11 6 789 543
24.0136-0122.1	436122		B	HC		V	380,0	36,0	34,0	48,0	108,0	5	71,0	200,0	14,0	JAGUAR C2P 12622
24.0136-0123.1	436123	S	B	HC		V	360,0	36,0	34,0	68,5	130,0	5	85,0	160,0	15,4	VOLKSWAGEN 7P6 615 301 A 958 351 403 01
24.0136-0124.1	436124	S	B	HC		V	360,0	36,0	34,0	68,5	130,0	5	85,0	160,0	15,4	VOLKSWAGEN 7P6 615 302 A
24.0136-0125.2	436125	S	B	HC		V●	400,0	36,0	34,4	63,2	120,0	5	75,0	198,0	16,5	PORSCHE 958 351 404 01
24.0136-0126.2	436126	S	B	HC		V●	400,0	36,0	34,4	63,2	120,0	5	75,0	198,0	16,5	BMW 34 11 2 284 102
24.0136-0127.1	436127	S	B	HC	L	V	360,0	36,0	34,0	68,6	130,0	5	98,0	160,0	15,4	BMW 34 11 2 284 101
																PORSCHE 970 351 404 00 298 615 302 B
24.0136-0128.1	436128	S	B	HC	L	V	360,0	36,0	34,0	68,6	130,0	5	98,0	160,0	15,4	PORSCHE 970 351 403 00 298 615 301 B





A large rectangular area containing 30 horizontal lines, spaced evenly for writing. This area occupies the majority of the page below the header.

Abmessungen PowerDisc

Dimensions PowerDisc - Misure PowerDisc -

Dimensions PowerDisc - Medidas PowerDisc

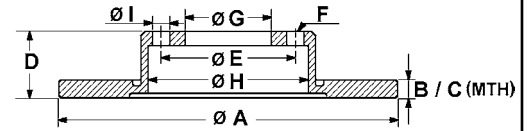

S Fixierschraube - fixing screw - vite di riparazione - vis de fixation - tornillo quefija

B beschichtet - coated - rivestito - revêtu - recubierto

HC hochgekohlt - high carbon - ad alto tenore di carbonio - à haute teneur en carbone - altamente carbonizado

L legiert - alloyed - alligato/legato - allié - aleado

V ventiliert - ventilated - ventilato - ventilé - ventilado

		S	B	HC	L	V	A	B	C	D	E	F	G	H	I	OE - #	
24.0308-0111.1	508111		B				258,0	8,0	7,0	55,3	112,0	5	67,0	164,0	13,0	MERCEDES BENZ	168 423 02 12
24.0308-0113.1	508113		B				258,0	8,0	7,0	57,3	112,0	5	67,0	164,0	15,0	MERCEDES BENZ	169 423 09 12
24.0309-0114.1	509114		S				278,0	9,0	7,3	55,5	112,0	5	67,0	164,0	13,2	CHRYSLER	5098 066AA
			B													MERCEDES BENZ	203 423 01 12 210 423 01 12 210 423 04 12 210 423 09 12
24.0309-0120.1	509120		S				258,0	9,0	7,3	55,5	112,0	5	67,0	164,0	12,8	MERCEDES BENZ	202 423 00 12
24.0309-0123.1	509123		S				230,0	9,0	7,0	40,6	100,0	5	65,0	125,8	15,6	AUDI/SEAT/SKODA/VW	1J0 615 601 C 1J0 615 601 P
24.0309-0133.1	509133		S				239,0	8,9	7,0	33,4	100,0	5	65,0	132,5	15,8	AUDI/VW/SKODA	1J0 615 601 D
24.0309-0154.1	509154		S				278,0	9,0	7,3	57,5	112,0	5	67,0	164,0	15,0	MERCEDES BENZ	000 423 13 12
24.0310-0115.1	510115		B				253,0	10,2	8,9	33,0	108,0	4	63,5	155,0	13,7	FORD	1514237 1756882 1780880 4083484 5022666 5030658 95GJ-2A315-EC C1BC-2A315-AA
24.0310-0117.1	510117		S	B	HC		300,0	10,0	7,6	61,0	120,0	5	75,0	180,0	14,5	BMW	34 21 1 162 305
24.0310-0150.1	510150		B				258,0	10,0	7,6	60,0	100,0	4	62,0	160,8	14,5	BMW	34 21 6 755 407
24.0310-0151.1	510151		S	B			239,0	10,0	8,0	38,9	100,0	4	65,0	124,5	13,6	AUDI/SEAT/VW	811 615 301
24.0310-0201.1	510201		B				245,0	10,0	8,0	64,2	112,0	5	68,0	135,5	15,4	AUDI/SKODAVW	4A0 615 601 A
24.0310-0202.1	510202		S	B	HC		280,0	10,0	7,6	60,0	120,0	5	75,0	160,8	14,5	BMW	34 21 1 165 457 34 21 6 864 051
24.0310-0217.1	510217		S	B			290,0	10,0	8,3	55,5	112,0	5	67,0	164,0	13,3	MERCEDES BENZ	210 423 10 12
24.0310-0223.1	510223		S	B			268,0	10,0	8,0	45,8	112,0	5	68,2	154,5	16,8	FORD	1001094 1045995
																SEAT/VW	7M0 615 601 C
24.0310-0224.1	510224		B				245,0	10,0	8,0	48,0	112,0	5	68,0	135,5	15,4	AUDI/VW	8D0 615 601 A 8E0 615 601 A
24.0310-0225.1	510225		S	B			270,0	10,0	8,0	69,3	100,0	4	57,0	160,0	14,0	OPEL/VAUXHALL	5 69 209/90512909
24.0310-0226.1	510226		S	B			286,0	10,0	8,0	69,3	110,0	5	65,5	160,0	14,0	OPEL/VAUXHALL SAAB	5 69 210/90512910 4565693 5391578
24.0310-0227.1	510227		S	B	HC		298,0	10,0	7,6	61,0	120,0	5	75,0	185,0	14,5	BMW	34 21 1 163 835 34 21 6 767 049
24.0310-0250.1	510250		S	B			264,0	9,8	8,0	42,0	110,0	5	65,5	145,0	14,0	OPEL/VAUXHALL	5 69 109/9117772
24.0310-0251.1	510251		S	B			240,0	9,8	8,0	42,0	100,0	4	57,0	140,8	14,0	OPEL/VAUXHALL	5 69 111/9196587
24.0310-0260.1	510260		B				255,0	10,0	8,0	48,1	112,0	5	68,0	144,5	15,3	AUDI	4B0 615 601 B
24.0310-0261.1	510261		B				245,0	10,0	8,0	40,0	112,0	5/9	68,0	135,5	15,3	AUDI	8E0 615 601 B 8E0 615 601 P
24.0310-0271.1	510271		B				259,0	10,0	7,6	44,1	100,0	4	64,2	163,0	16,0	MINI	34 21 1 503 070 34 21 6 774 987
24.0310-0277.1	510277		S	B			253,0	10,0	8,0	51,6	112,0	5/9	65,0	140,0	15,3	AUDI/SEAT/SKODA/VW	1K0 615 601 K 1K0 615 601 AB
24.0310-0278.1	510278		S	B			300,0	10,0	8,3	68,3	112,0	5	67,0	180,0	15,3	MERCEDES BENZ	000 423 10 12 211 423 07 12
24.0310-0291.1	510291		S	B			264,0	10,0	8,0	42,0	100,0	4	57,0	145,0	14,0	OPEL/VAUXHALL	5 69 116/93176548
24.0310-0314.1	510314		S	B	HC		280,0	10,0	7,6	65,5	120,0	5	75,0	160,8	14,5	BMW	34 21 6 855 001
24.0310-0315.1	510315		S	B	HC		296,0	10,4	8,9	65,5	120,0	5	75,0	160,8	14,5	BMW	34 21 4 031 725 34 21 6 764 649 34 21 6 855 002
24.0310-0328.1	510328		S	B			300,0	10,0	8,3	57,5	112,0	5	67,0	164,0	15,3	MERCEDES BENZ	204 423 15 12
24.0310-0349.1	510349		B				251,0	10,0	9,0	40,5	98,0	4	59,0	128,0	13,2	ALFA ROMEO	51805559 51813705 51865104 51865132
24.0310-0356.1	510356		S	B			272,0	9,7	8,0	48,2	112,0	9	65,0	174,5	15,3	AUDI/SEAT/SKODA/VW	1K0 615 601 AA
24.0311-0141.1	511141		B				256,0	10,8	8,0	41,1	100,0	6	60,0	123,0	14,3	OPEL/VAUXHALL	5 69 058/9117676
24.0311-0145.1	511145		B				302,0	10,9	9,0	50,8	108,0	5	63,5	177,6	15,8	FORD	1379931 1385590 1405500 LR027123
24.0311-0155.1	511155		B				265,0	11,0	9,0	40,8	108,0	5	63,5	152,0	13,7	LAND ROVER FORD	1223540 1253728 1373360 1575733 1748745 9M51-2A315-BA 9M51-2A315-BB

Abmessungen PowerDisc

Dimensions PowerDisc - Misure PowerDisc -

Dimensions PowerDisc - Medidas PowerDisc

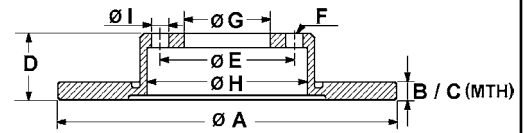

S Fixierschraube - fixing screw - vite di riparazione - vis de fixation - tornillo quefija

B beschichtet - coated - rivestito - revêtu - recubierto

HC hochgekohlt - high carbon - ad alto tenore di carbonio - à haute teneur en carbone - altamente carbonizado

L legiert - alloyed - alligato/legato - allié - aleado

V ventiliert - ventilated - ventilato - ventilé - ventilado

		S	B	HC	L	V	A	B	C	D	E	F	G	H	I	OE - #
24.0311-0158.1	511158		B				280,0	11,0	9,0	41,0	108,0	5	63,5	192,0	13,7	FORD 1253962 1373361 1500156 7M51-2A315-BA VOLVO 30769113 31341645
24.0311-0171.1	511171		B				271,0	11,0	9,0	40,7	108,0	5	63,5	152,0	13,8	FORD 1704765
24.0312-0106.1	512106	S	B				239,0	12,0	10,0	35,4	100,0	4	65,0	124,5	13,6	AUDI/SEAT/VW 321 615 301 AUDI/VW 175 615 301
24.0312-0125.1	512125		B				239,0	12,0	10,8	42,5	98,0	4	58,5	127,0	13,1	LADA 2108-3501070
24.0312-0126.1	512126	S	B				286,0	12,0	9,6	51,5	120,0	5	79,0	148,0	14,5	BMW 34 11 6 757 750 34 11 6 757 751
24.0312-0141.1	512141		B				239,5	12,0	10,0	42,9	108,0	4	63,5	136,0	13,7	FORD 1013581 1019598 1112542 MAZDA 1E03-33-251 1E03-33-251A 1E04-33-251
24.0312-0144.1	512144	S	B	HC	L		260,0	12,0	10,0	40,4	112,0	5	67,0	145,0	13,3	MERCEDES BENZ 168 421 01 12
24.0312-0148.1	512148		B				255,0	12,0	10,0	40,0	112,0	5/9	68,0	144,5	15,3	AUDI 8E0 615 601 D 8E0 615 601 Q
24.0312-0151.1	512151		B				288,0	11,9	10,0	64,8	108,0	5	68,0	178,0	16,5	VOLVO 9434167
24.0312-0152.1	512152		B	HC			324,0	12,0	9,6	80,2	120,0	5	75,0	185,0	16,8	BMW 34 21 6 859 678
24.0312-0154.1	512154		B				280,0	12,0	10,0	34,0	108,0	5	63,5	151,0	13,7	FORD 1676983 4176921 4179406 7S7J-2A315-BB JAGUAR C2S 49730 C2S 52088
24.0312-0157.1	512157	S	B				278,0	11,9	10,0	41,4	110,0	5	65,5	145,2	14,0	FIAT 46836489 71772552 OPEL/VAUXHALL 5 69 115/93171848 SAAB 9156785 12762290
24.0312-0158.1	512158		B				256,0	12,0	10,0	48,6	112,0	5/9	65,0	140,0	15,3	AUDI/SKODA/VW 1K0 615 601 L 1K0 615 601 AC
24.0312-0159.1	512159		B				302,0	12,0	10,0	49,4	112,0	5/9	68,0	177,0	15,3	AUDI 4F0 615 601 E
24.0312-0166.1	512166		B				288,0	12,0	10,0	36,0	112,0	5	68,0	162,0	15,3	AUDI 8E0 615 601 M
24.0312-0167.1	512167	S	B	HC	L		276,0	12,0	10,0	44,5	112,0	5	67,0	145,0	15,3	MERCEDES BENZ 169 421 00 12
24.0312-0178.1	512178	S	B				300,0	12,0	10,0	36,4	112,0	5	68,0	169,0	15,3	AUDI 8K0 615 601 B
24.0312-0187.1	512187	S	B				292,0	12,0	10,5	48,0	120,0	5	67,4	171,5	16,3	OPEL/VAUXHALL 5 69 025/13501302 5 69 127/13502198 SAAB 13502198
24.0312-0188.1	512188	S	B				268,0	12,0	10,0	44,9	105,0	5	60,0	147,0	14,2	CHEVROLET 13502135/13502136 OPEL/VAUXHALL 5 69 074/13502134
24.0312-0189.1	512189	S	B				292,0	12,0	10,0	45,0	115,0	5	70,7	157,0	14,2	CHEVROLET 13502139 OPEL/VAUXHALL 5 69 071/13502138 5 69 075/13502137 5 69 085/13504280
24.0313-0161.1	513161	S	B				236,0	12,7	9,7	41,0	100,0	4/6	60,0	123,0	14,0	OPEL/VAUXHALL 5 69 020/90008005 5 69 030/90008031 5 69 013/93182290
24.0313-0178.1	513178	S	B				255,6	12,9	11,0	39,2	100,0	4	65,0	135,5	13,6	SEAT/VW 357 615 301
24.0313-0181.1	513181		B	HC			280,0	13,0	11,0	46,5	112,0	5	68,0	159,0	15,4	AUDI 8D0 615 301 A
24.0313-0184.1	513184	S	B				266,0	13,0	11,0	27,2	108,0	4	66,0	133,0	13,0	CITROEN 16 086 916 80 4246 R4 4249 82
24.0313-0185.1	513185	S	B				247,5	13,0	11,0	34,2	108,0	4	66,0	133,0	13,0	PEUGEOT 16 086 916 80 4246 R2 CITROEN 4246 R9 PEUGEOT 4246 R8 4249 A5
24.0315-0105.1	515105		B	HC			288,0	15,0	13,0	46,5	112,0	5	68,0	135,5	15,4	AUDI 4A0 615 301 B
24.0318-0106.1	518106	S	B	HC	V		239,0	18,0	16,0	34,5	100,0	4	65,0	125,0	13,6	SEAT/VW 6N0 615 301 C VOLKSWAGEN 6N0 615 301 F
24.0318-0137.1	518137	S	B	HC	V		239,0	18,0	16,0	35,0	100,0	5	65,0	125,0	15,6	SKODA/VW 6Q0 615 301 VOLKSWAGEN 6Q0 615 301 A
24.0319-0107.1	519107	S	B	HC	V		276,0	19,0	16,6	60,3	120,0	5	75,0	160,8	14,5	BMW 34 21 6 864 903 34 21 6 864 903
24.0319-0108.1	519108	S	B	HC	V		294,0	18,9	17,4	59,7	120,0	5	75,0	160,8	14,8	BMW 34 21 1 165 563 34 21 6 864 056
24.0320-0115.1	520115	S	B	HC	L	V	236,0	20,0	17,0	41,0	100,0	4/6	60,0	123,0	14,0	CHEVROLET 90121445 DAEWOO 90121445 OPEL/VAUXHALL 5 69 054/90511111



Abmessungen PowerDisc

Dimensions PowerDisc - Misure PowerDisc -

Dimensiones PowerDisc - Medidas PowerDisc

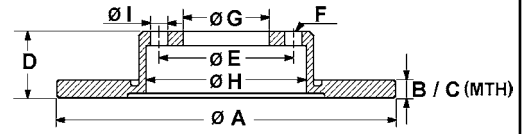

S Fixierschraube - fixing screw - vite di riparazione - vis de fixation - tornillo quefija

B beschichtet - coated - rivestito - revêtu - recubierto

HC hochgekohlt - high carbon - ad alto tenore di carbonio - à haute teneur en carbone - altamente carbonizado

L legiert - alloyed - alligato/legato - allié - aleado

V ventiliert - ventilated - ventilato - ventilé - ventilado

		S	B	HC	L	V	A	B	C	D	E	F	G	H	I	OE - #	
24.0320-0123.1	520123	S	B	HC	L	V	239,0	20,0	18,0	39,0	100,0	4	65,0	123,8	13,6	AUDI/SEAT/VW AUDI/VW	321 615 301 C 321 615 301 A 321 615 301 D 6N0 615 301 D
24.0320-0128.1	520128	S	B	HC	L	V	256,0	20,0	18,0	38,8	100,0	4	65,0	131,5	13,8	SEAT/VW	95 661 747 4246 A7 4249 96
24.0320-0132.1	520132	S	B			V	247,0	20,4	18,5	34,2	108,0	4	66,0	133,2	12,8	CITROEN PEUGEOT	4249 F0 4246 97 4249 F0
24.0320-0133.1	520133	S	B			V	266,0	20,5	18,5	27,6	108,0	4	66,0	133,0	13,0	CITROEN PEUGEOT	7779409 71738145 51749124 60806137 60810076 60811256 60811266
24.0320-0142.1	520142		B	HC	L	V	257,5	20,0	18,2	40,5	98,0	4	59,0	126,7	13,0	ALFA/FIAT/LANCIA	4115996 5026786
24.0320-0146.1	520146		B			V	253,0	20,0	18,0	43,7	108,0	4	63,5	153,0	13,7	FORD	1019604 1066271 1320581 1320582 5028281
24.0320-0147.1	520147		B			V	239,5	20,0	18,0	43,0	108,0	4	63,5	136,0	13,7	FORD/MAZDA	34 21 1 164 175 34 21 6 767 060
24.0320-0154.1	520154	S	B	HC		V	298,0	20,0	17,6	61,3	120,0	5	75,0	185,0	14,5	BMW	46836490 71772548
24.0320-0173.1	520173	S	B			V	292,0	19,9	18,0	41,4	110,0	5	65,5	162,5	14,0	FIAT OPEL/VAUXHALL SAAB	5 69 114/93171778 9191336 12762291
24.0320-0175.1	520175		B			V	255,0	20,0	18,0	43,1	100,0	4	55,0	129,0	14,5	TOYOTA	43512-0D050 43512-17120 43512-17130 43512-17131 43512-52040 43512-52090
24.0320-0183.1	520183	S	B	HC		V	320,0	20,0	18,4	63,2	120,0	5	75,0	185,0	14,5	BMW	34 21 6 772 085
24.0320-0195.1	520195	S	B	HC		V	300,0	20,0	18,4	66,0	120,0	5	75,0	160,8	14,5	BMW	34 21 6 855 007
24.0320-0204.1	520204	S	B	HC		V	300,0	20,0	18,4	66,1	120,0	5	75,0	185,0	14,5	BMW	34 21 6 864 901
24.0320-0213.1	520213	S	B	HC		V	320,0	20,0	18,4	86,1	120,0	5	75,0	185,0	14,5	BMW	34 21 6 763 345
24.0320-0234.1	520234	S	B	HC		V	330,0	20,0	18,4	71,0	120,0	5	75,0	154,0	16,5	BMW	34 20 6 868 936
24.0322-0100.1	522100		B	HC		V	280,0	22,0	20,0	28,5	100,0	5	65,0	141,0	15,6	SEAT/VW	1H0 615 301 A
24.0322-0103.1	522103	S	B	HC		V	302,0	22,0	19,6	76,0	120,0	5	79,0	149,0	14,5	BMW	34 11 1 160 936
24.0322-0115.1	522115	S	B	HC		V	286,0	22,0	19,6	51,5	120,0	5	79,0	147,5	14,5	BMW	34 11 1 165 455 34 11 6 766 239 34 11 6 794 301 34 11 6 864 060
24.0322-0122.1	522122		B	HC	L	V	260,0	22,0	19,6	35,0	100,0	4	66,0	138,0	14,5	BMW	34 11 1 160 915
24.0322-0132.1	522132	S	B	HC	L	V	284,0	22,0	19,4	43,5	112,0	5	67,0	154,3	12,8	MERCEDES BENZ	202 421 09 12
24.0322-0150.1	522150	S	B	HC		V	280,0	22,0	19,0	36,7	100,0	5	65,0	133,5	15,6	AUDI/SEAT/SKODA/VW	1J0 615 301 E 1J0 615 301 M 1J0 615 301 P
24.0322-0151.1	522151	S	B	HC		V	256,0	22,0	19,0	36,7	100,0	5	65,0	133,5	15,6	AUDI/SEAT/SKODA/VW	1J0 615 301 D 1J0 615 301 L 6R0 615 301
24.0322-0152.1	522152		B	HC		V	280,0	22,0	20,0	46,3	112,0	5/9	68,0	146,5	15,3	AUDI/VW AUDI/VW	8Z0 615 301 D 8E0 615 301 B 8E0 615 301 D 8E0 615 301 P
24.0322-0159.1	522159	S	B	HC		V	296,0	22,0	19,6	76,3	120,0	5	79,0	148,8	14,5	BMW	34 11 6 767 061
24.0322-0160.1	522160	S	B	HC		V	300,0	22,0	19,6	51,8	120,0	5	79,0	164,0	14,5	BMW	34 11 1 164 539 34 11 6 757 526 34 11 6 766 224 34 11 6 864 058 34 11 6 794 302
24.0322-0161.1	522161	S	B	HC	L	V	276,0	22,0	19,0	77,2	130,0	5	85,0	156,3	15,0	MERCEDES BENZ	902 421 06 12 902 421 07 12 902 421 09 12
24.0322-0162.1	522162	S	B	HC	L	V	276,0	22,0	19,0	60,0	112,0	5	67,0	153,0	15,0	MERCEDES BENZ	2D0 615 301 C 2D0 615 301 D
24.0322-0163.1	522163		B	HC		V	256,0	22,0	20,0	36,6	100,0	5	65,0	135,0	15,6	AUDI/VW	638 421 01 12 8N0 615 601 B



Abmessungen PowerDisc

Dimensions PowerDisc - Misure PowerDisc -

Dimensions PowerDisc - Medidas PowerDisc

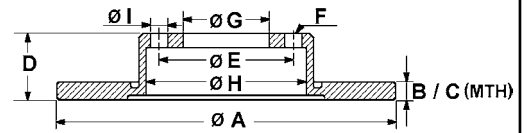

S Fixierschraube - fixing screw - vite di riparazione - vis de fixation - tornillo quefija

B beschichtet - coated - rivestito - revêtu - recubierto

HC hochgekohlt - high carbon - ad alto tenore di carbonio - à haute teneur en carbone - altamente carbonizado

L legiert - alloyed - alligato/legato - allié - aleado

V ventiliert - ventilated - ventilato - ventilé - ventilado

		S	B	HC	L	V	A	B	C	D	E	F	G	H	I	OE - #		
24.0322-0168.1	522168	S	B	HC	L	V	260,0	22,0	19,4	40,4	112,0	5	67,0	145,0	13,3	MERCEDES BENZ	168 421 02 12 168 421 08 12	
24.0322-0170.1	522170					V	257,0	22,0	20,0	34,0	104,0	4	86,0	160,5	10,6	HYUNDAI	51712-28300	
24.0322-0172.1	522172		B			V	258,0	22,0	20,0	43,4	108,0	4	63,5	136,0	13,7	FORD/MAZDA	1808479 98AX-1125-B1F	
24.0322-0197.1	522197		B			V	257,5	22,0	20,2	40,5	98,0	4	59,0	127,0	13,0	CITROEN	4249 74 4249 L2	
																FIAT/LANCIA	46401356 46542383 46831041 51896287 51896288	
																PEUGEOT	4249 73 4249 L2	
24.0322-0199.1	522199		B	HC	L	V	270,0	22,0	19,4	35,5	112,0	5	67,0	145,0	13,3	MERCEDES BENZ	414 421 00 12	
24.0322-0204.1	522204		B	HC		V	276,0	22,0	19,6	44,2	100,0	4	64,2	150,0	14,7	MINI	34 11 6 774 984	
24.0322-0209.1	522209	S	B	HC		V	320,0	22,0	20,4	60,5	120,0	5	75,0	185,0	14,5	BMW	34 20 1 166 073	
24.0322-0210.1	522210	S	B	HC		V	280,0	22,0	19,0	49,9	112,0	5/9	65,0	144,0	15,3	AUDI/SEAT/VW	1K0 615 301 AK	
24.0322-0223.1	522223		B	HC		V	330,0	22,0	20,0	49,4	112,0	5	68,0	138,0	15,3	AUDI	4F0 615 601 F	
24.0322-0224.1	522224	S	B	HC		V	320,0	22,0	20,4	79,7	120,0	5	75,0	185,0	16,5	BMW	34 21 3 332 217	
24.0322-0231.1	522231	S	B			V	257,0	22,0	20,0	40,5	100,0	4/6	60,0	126,0	14,5	FIAT	55700920 55700921	
																OPEL/VAUXHALL	5 69 024/93188917 5 69 065/9319724	
24.0322-0232.1	522232	S	B	HC	L	V	276,0	22,0	19,4	44,5	112,0	5	67,0	145,0	15,3	MERCEDES BENZ	169 421 08 12	
24.0322-0236.1	522236	S	B	HC		V	336,0	22,0	20,4	67,3	120,0	5	75,0	185,0	14,5	BMW	34 21 6 855 004	
24.0322-0238.1	522238	S	B	HC		V	292,0	22,0	19,6	73,3	120,0	5	79,0	151,5	14,5	BMW	34 11 6 854 997	
24.0322-0239.1	522239	S	B	HC		V	284,0	22,0	19,6	73,3	120,0	5	79,0	151,5	16,6	BMW	34 11 6 854 996 34 11 6 774 986 34 11 6 858 652	
24.0322-0247.1	522247		B	HC		V	294,0	22,0	20,4	44,2	100,0	4	64,2	150,0	16,2	MINI	34 11 6 774 985 34 11 6 858 651	
24.0322-0248.1	522248		B	HC		V	280,0	22,0	20,4	44,2	100,0	4	64,2	150,0	16,2	MINI	34 11 6 774 985 34 11 6 858 651	
24.0323-0113.1	523113		B	HC		V	258,0	23,0	21,0	43,8	108,0	4	63,5	136,0	13,0	FORD	1523795 1535924 1546835 1679853	
																	CHEVROLET	8V51-1125-AC 8V51-1125-AD
24.0323-0114.1	523114	S	B			V	315,0	22,9	21,5	48,0	120,0	5	67,4	172,0	16,3	CHEVROLET	13501314	
																	OPEL/VAUXHALL	5 69 062/13501303 5 69 128/13502199 13502199
24.0324-0115.1	524115	S	B	HC	L	V	256,0	24,0	21,0	41,0	100,0	4/6	60,0	123,0	14,0	DAEWOO	96179110	
																	OPEL/VAUXHALL	5 69 001/90487402
24.0324-0120.1	524120		B			V	260,0	24,0	22,2	47,0	108,0	4	63,5	136,0	13,6	FORD	4070865 5026784	
24.0324-0152.1	524152	S	B	HC	L	V	256,0	23,8	21,0	41,1	100,0	4	60,0	123,0	14,3	OPEL/VAUXHALL	5 69 059/9117677	
24.0324-0158.1	524158	S	B	HC	L	V	280,0	24,0	21,8	44,0	100,0	4	61,0	140,0	13,6	RENAULT	77 01 207 829 86 71 005 975	
24.0324-0159.1	524159		B			V	281,0	23,9	21,5	45,7	114,3	4	69,0	146,5	12,5	MITSUBISHI	M818027	
																	VOLVO	30818027
24.0324-0161.1	524161		B			V	300,0	23,9	22,0	47,0	108,0	5	63,5	155,0	13,7	FORD	1376118 4179398 4181042	
																	JAGUAR	C2S 35270 C2S 42667 C2S 52091
24.0324-0166.1	524166		B	HC	L	V	260,0	24,0	21,0	41,0	100,0	4/6	60,0	126,0	14,5	OPEL/VAUXHALL	5 69 000/9196050	
24.0324-0171.1	524171	S	B	HC	L	V	280,0	24,0	21,8	44,0	108,0	5	61,0	140,0	15,5	RENAULT	77 01 206 198	
24.0324-0181.1	524181	S	B	HC		V	310,0	24,0	21,6	77,0	120,0	5	79,0	161,0	14,5	BMW	34 11 6 764 021	
24.0324-0197.1	524197	S	B	HC		V	300,0	24,0	21,6	73,5	120,0	5	79,0	152,0	14,5	BMW	34 11 6 764 643 34 11 6 854 998 34 11 6 854 999	
24.0324-0200.1	524200	S	B	HC		V	330,0	24,0	21,6	73,3	120,0	5	79,0	174,0	14,5	BMW	34 11 6 854 999	
24.0324-0203.1	524203	S	B	HC		V	312,0	23,9	22,4	73,7	120,0	5	79,0	152,0	14,5	BMW	34 11 6 792 219 34 11 6 855 006	
24.0325-0105.1	525105		B	HC		V	288,0	25,0	23,0	46,5	112,0	5/9	68,0	135,0	15,4	AUDI/SEAT/SKODA	4A0 615 301 C 4A0 615 301 D 8E0 615 301 Q	
24.0325-0110.1	525110	S	B	HC	L	V	288,0	25,0	22,4	46,5	112,0	5	67,0	154,3	13,2	MERCEDES BENZ	203 421 03 12 210 421 07 12 210 421 24 12	

Abmessungen PowerDisc

Dimensions PowerDisc - Misure PowerDisc -

Dimensiones PowerDisc - Medidas PowerDisc

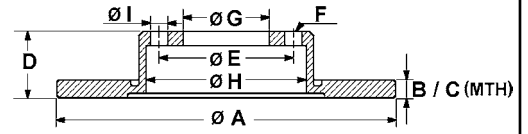

S Fixierschraube - fixing screw - vite di riparazione - vis de fixation - tornillo quefija

B beschichtet - coated - rivestito - revêtu - recubierto

HC hochgekohlt - high carbon - ad alto tenore di carbonio - à haute teneur en carbone - altamente carbonizado

L legiert - alloyed - alligato/legato - allié - aleado

V ventiliert - ventilated - ventilato - ventilé - ventilado

		S	B	HC	L	V	A	B	C	D	E	F	G	H	I	OE - #	
24.0325-0113.1	525113	S	B	HC		V	288,0	25,0	22,0	34,5	100,0	5	65,0	136,0	15,6	AUDI/SEAT/SKODA/VW	1J0 615 301 R 1J0 615 301 S 6R0 615 301 A
24.0325-0114.1	525114	S	B	HC		V	288,0	25,1	21,0	55,4	112,0	5	68,2	144,2	16,5	FORD SEAT/VW	1045994 7M0 615 301 G
24.0325-0115.1	525115		B	HC		V	282,5	25,0	23,0	46,5	112,0	5	68,0	135,0	15,3	VOLKSWAGEN	8E0 615 301 A 8E0 615 301 C
24.0325-0117.1	525117		B	HC		V	278,0	25,0	23,0	48,5	108,0	5	63,5	140,0	13,7	FORD	1373369 1734696 AV61-1125-BB
24.0325-0119.1	525119	S	B	HC	L	V	288,0	25,0	22,0	42,0	110,0	5/7	70,0	139,0	14,0	VOLVO OPEL/VAUXHALL	31262718 5 69 056/90512029
24.0325-0123.1	525123		B	HC		V	310,0	25,0	22,0	34,5	100,0	5/9	65,0	185,0	15,6	AUDI/SEAT/SKODA/VW	5390786 6R0 615 301 B 8N0 615 301 A 8L0 615 301
24.0325-0131.1	525131	S	B	HC	L	V	280,0	24,8	22,0	42,0	110,0	5/7	70,0	139,0	14,0	AUDI/VW OPEL/VAUXHALL	5 69 066/93197592 4B0 615 301 A
24.0325-0137.1	525137		B	HC		V	312,0	25,0	23,0	46,5	112,0	5	68,0	158,0	15,3	AUDI/SKODA	8E0 615 301 R 8E0 615 301 R
24.0325-0138.1	525138	S	B	HC		V	325,0	24,9	22,5	52,6	120,0	5	79,0	174,0	14,5	BMW	34 10 1 166 071 34 11 6 864 047
24.0325-0141.1	525141	S	B	HC		V	285,0	24,9	22,0	42,1	110,0	5/7	70,0	139,0	14,0	FIAT OPEL/VAUXHALL SAAB	51819733 71772553 5 69 003/93171497 9156807 93171497
24.0325-0142.1	525142	S	B	HC	L	V	308,0	25,0	22,0	42,0	110,0	5/8	70,0	139,0	14,0	OPEL/VAUXHALL SAAB	5 69 061/9194477 5391560 9184405
24.0325-0145.1	525145	S	B	HC		V	288,0	25,0	22,0	49,9	112,0	5/9	65,0	144,0	15,3	AUDI/SEAT/SKODA/VW	1K0 615 301 T JZW 615 301 J
24.0325-0148.1	525148	S	B	HC	L	V	280,0	25,0	22,0	42,0	100,0	4/6	60,0	139,0	14,5	OPEL/VAUXHALL	5 69 006/93175376
24.0325-0149.1	525149		B	HC		V	314,0	25,0	23,0	59,7	112,0	5	68,0	144,0	15,3	AUDI	4F0 615 301 D
24.0325-0158.1	525158	S	B	HC		V	312,0	25,0	22,0	49,9	112,0	5/9	65,0	146,0	15,3	AUDI/VW/SKODA	1K0 615 301 AA JZW 615 301 H
24.0325-0160.1	525160	S	B	HC		V	325,0	25,0	22,6	62,2	120,0	5	75,0	174,0	16,5	BMW	34 11 3 400 151
24.0325-0162.1	525162		B	HC		V	300,0	25,0	23,0	48,5	108,0	5	63,5	140,0	13,7	FORD VOLVO	1253965 1373370 1520297 1797226 DV61-1125-DA 274510 31341643 31362412 31381375 31400937 31400941
24.0325-0167.1	525167	S	B	HC	L	V	288,0	25,0	22,4	44,5	112,0	5	67,0	154,3	15,3	MERCEDES BENZ	169 421 11 12
24.0325-0171.1	525171		B	HC		V	288,0	25,0	23,0	46,5	112,0	5/10	68,0	137,0	15,3	SKODA/VW	4B0 615 301 B
24.0325-0172.1	525172		B	HC		V	312,0	25,0	23,0	46,5	112,0	5/10	68,0	140,0	15,3	SKODA/VW	4B0 615 301 C
24.0325-0179.1	525179	S	B	HC	L	V	288,0	25,0	22,4	64,5	112,0	5	67,0	154,3	15,2	MERCEDES BENZ	000 421 19 12
24.0325-0184.1	525184	S	B	HC		V	314,0	25,0	23,0	52,4	112,0	5	68,0	154,0	15,3	AUDI	8K0 615 301
24.0325-0197.1	525197		B	HC		V	320,0	25,0	23,0	48,5	108,0	5	63,5	148,0	13,7	FORD VOLVO	1724956 3M51-2C375-CE 31302573 31329122 31341644 31381376 31400818 31400942
24.0325-0198.1	525198	S	B	HC	L	V	280,0	25,0	22,0	43,2	100,0	4/6	60,0	139,0	14,5	OPEL/VAUXHALL	5 69 007/93181113 5 69 067/93197712
24.0325-0199.1	525199		B	HC		V	278,0	25,0	23,0	48,5	108,0	5	63,5	140,0	13,7	FORD	1790221 AV61-1125-DB
24.0326-0106.1	526106	S	B			V	283,0	26,0	24,2	28,2	108,0	4	66,0	133,5	13,0	CITROEN PEUGEOT	4246 L8 4246 R7
24.0326-0107.1	526107		B	HC		V	302,0	26,0	23,0	50,0	108,0	5	68,0	151,0	14,4	VOLVO	272276
24.0326-0115.1	526115		B	HC		V	300,0	26,0	22,0	56,0	112,0	5	68,2	144,0	16,5	FORD SEAT/VW	1141782 7M3 615 301 A
24.0326-0119.1	526119		B	HC		V	313,0	25,9	22,0	56,2	112,0	5	68,2	148,0	16,5	FORD SEAT/VW	1108038 7M3 615 301



Abmessungen PowerDisc

Dimensions PowerDisc - Misure PowerDisc - Dimensiones PowerDisc - Medidas PowerDisc

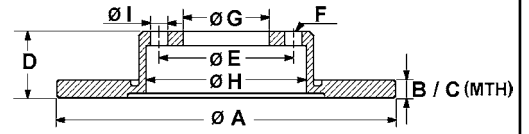

S Fixierschraube - fixing screw - vite di riparazione - vis de fixation - tornillo quefija

B beschichtet - coated - rivestito - revêtu - recubierto

HC hochgekohlt - high carbon - ad alto tenore di carbonio - à haute teneuren carbone - altamente carbonizado

L legiert - alloyed - alligato/legato - allié - aleado

V ventiliert - ventilated - ventilato - ventilé - ventilado

		S	B	HC	L	V	A	B	C	D	E	F	G	H	I	OE - #	
24.0332-0144.1	532144	S	B	HC	L	V	330,0	32,0	29,4	64,5	112,0	5	67,0	154,0	15,0	MERCEDES BENZ	204 421 29 12 211 421 10 12 211 421 13 12 211 421 14 12
24.0332-0158.1	532158	S	B	HC	L	V	330,0	32,0	29,4	54,5	112,0	5	67,0	156,3	15,2	MERCEDES BENZ	164 421 04 12 164 421 13 12



A large rectangular area containing 30 horizontal lines, intended for writing or drawing.



Ⓛ Armaturen

Ⓛ Fittings

Ⓛ Composants et accessoires

Ⓛ Assesorios

Armaturen

Fittings - Attrezzature - Composants et accessoires - Accesorios

Gewindedarstellung und Dichtflächen-Anordnung bei Innengewinden der Anschlußarmaturen

Representation of threads and sealing surface arrangement in case of internal-threads

Rappresentazione della filattatura e disposizione delle superfici di tenuta nella filettatura interna dei pezzi di attacco

Présentation de filet et arrangement de face d'étanchéité en case de filetage intérieure des armatures

Ilustración de roscas y disposición de superficies de contacto en roscas interiores de los accesorios de conexión

Abdichtung durch Bördel nach DIN 74234
Sealing by flaring according to DIN 74234 tenuta
Stagna tramite flangiatura DIN 74234
Etanchement par colet selon DIN 74234
Junta mediante reborde según DIN 74234

Abdichtung mit Dichtring nach DIN 7603
Sealing by seal ring according to DIN 7603
Tenuta stagna tramite guarnizione DIN 7603
Etanchement par joint selon DIN 7603
Junta con retén según DIN 7603

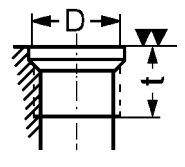
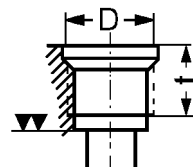
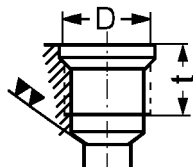
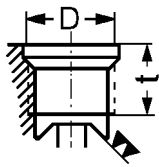

Gewinde Ausführung

Thread design
Esecuzione filettata
Exécution filet
Ejecución de rosca

A 1

A 2

A 3

A 4

Bördel

Flare
Bordatura tipo
Colet
Reborde

E

F

-

-

DIN 74233

Überwurfschraube
Union screw
Viti con risvolto
Vis chapeau
Tornillos de racor

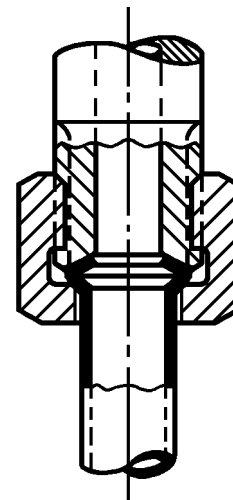
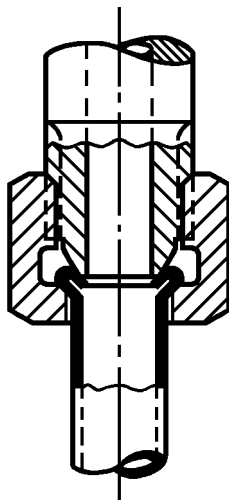

DIN 74234





E

F

Bördel
Flare
Bordatura tipo
Colet
Reborde

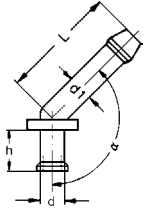
Armaturen

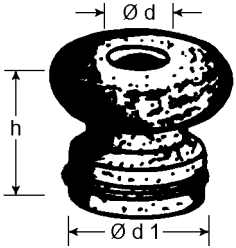
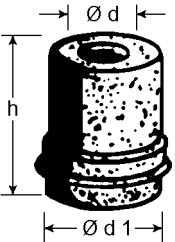
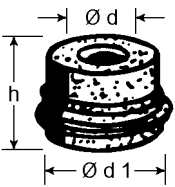
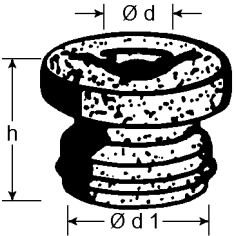
Fittings - Attrezzature - Composants et accessoires - Accesorios

Kniestücke Elbows Raccordi a gomito Raccord en équerre Piezas acodadas	Abmessungen - Dimensions - Dimensioni - Dimensions - Medidas [mm]					
	$\varnothing d$	$\varnothing d_1$	h	L	α	
	8,0	8,0	11,0	32,0	95°	03.3390-0055.1 390149
	8,0	8,0	11,0	32,0	105°	03.3390-0065.1 390150
	12,8	8,0	13,0	32,0	135°	03.3390-0130.1 390153
	12,8	8,0	13,0	32,0	105°	03.3390-0139.1 390154
Behälterstopfen Reservoir seal Tappi per serbatoio Bouchon de réservoir Taponés de depósitos	Abmessungen - Dimensions - Dimensioni - Dimensions - Medidas [mm]					
	4,2	17,0	18,0	Kautschuk ①	03.3304-0600.1 390081	
	6,5	17,0	18,0	Kautschuk ①	03.3304-0700.1 390082	
	6,5	17,0	10,5	Kautschuk ①	03.3304-1100.1 390084	
	6,5	17,0	10,4	EPDM	03.3304-1102.1 390085	
	7,3	17,0	13,5	Kautschuk ①	03.3304-1000.1 390083	
	7,3	22,0	13,0		03.3304-1400.1 390088	
	12,3	22,0	13,0	EPDM	03.3304-2208.1 390090	
	① Kautschuk India rubber Caucciù Caoutchouc Caucho					
Behälterschlauch Reservoir tube Flessibile per serbatoio Flexible réservoir Manguera del depósito	Abmessungen - Dimensions - Dimensioni - Dimensions - Medidas					
	$\varnothing D$ [mm]	$\varnothing d$ [mm]	L [m]			
	13,5	7,5	5,0	03.3538-0005.1 390414		
	13,5	7,5	20,0	03.3538-0020.1 390415		

Armaturen

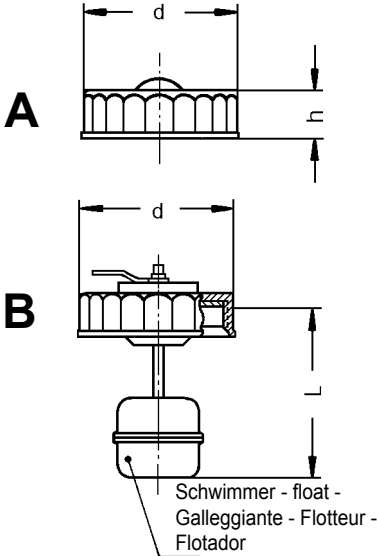

Fittings - Attrezzature - Composants et accessoires - Accesorios

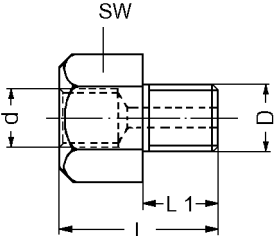
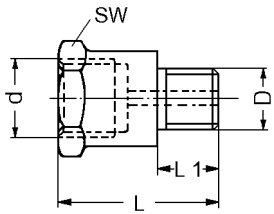
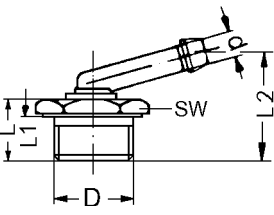
Behälter Verschraubung Reservoir screw fitting Tappi filettato per serbatoio Couvercle de réservoir Fijación de depósito	Abmessungen - Dimensions - Dimensioni - Dimensions - Medidas [mm]				
	Ausführung - Design - Esecuzione - Exécution - Ejecución	d	h	L	
	A	max. 51	14,0		03.3556-1065.2 390425
		max. 51	14,0		03.3556-1141.2 390434
		max. 51	14,5		03.3556-1147.2 390435 M
		max. 51	14,0		03.3556-1164.2 390437
	B	max. 51		45,5	03.3556-1094.2 390427
		max. 51		51,2	03.3556-1113.2 390428
		max. 51		83,0	03.3556-1115.2 390431
		max. 51		54,0	03.3556-1124.2 390433
		max. 51		40,5	03.3556-1199.2 390440
		M nur für Mineralöl only for mineral oil solo per olio minerale seulement pour huile minérale sólo para aceite mineral			

Schraubstutzen Screw adapters Raccordi filettati Raccord fileté Racores	Abmessungen - Dimensions - Dimensioni - Dimensions - Medidas [mm]							
	D	d	Gewinde Ausführung - Thread design - Esecuzione filettata - Exécution filet - Ejecución de rosca	L	L ₁	L ₂	SW	
	M 10 x 1	M 10 x 1	A 2	21,0	8,0		17	03.3510-0100.1 390271
		M 12 x 1	A 1	24,0	8,0		17	03.3510-0300.1 390273
	M 12 x 1	M 10 x 1	A 2	20,5	8,0		17	03.3510-0054.1 390269 ①
		M 12 x 1	A 1	22,0	8,0		17	03.3510-0059.1 390270
	M 14 x 1,5	M 10 x 1	A 2	26,0	14,0		19	03.3510-4100.1 390279
		M 12 x 1	A 2	27,0	12,0		19	03.3510-0800.1 390275
① mit Drosselbohrung with throttle hole con foro calibrato di strozzamento avec d'étranglement con taladro estrangulador								
	M 10 x 1	M 10 x 1	A 2	32,0	8,0		17	03.3510-0200.1 390272
	M 22 x 1,5	Ø 10		16,5	12,0	30,0	27	03.3510-0026.2 390266



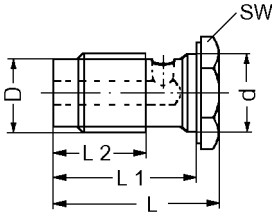
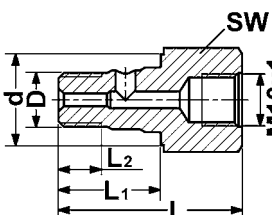

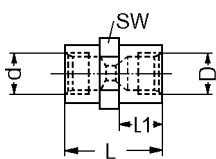
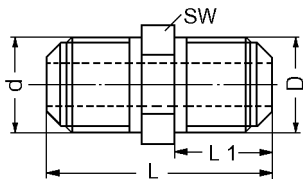
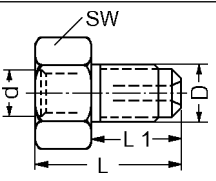
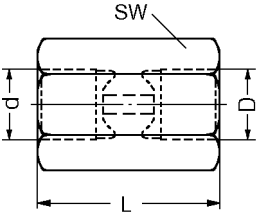
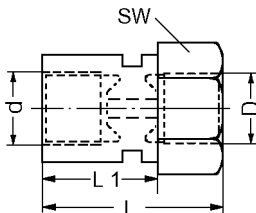
Armaturen

Fittings - Attrezzature - Composants et accessoires - Accesorios

Hohlschrauben Hollow screws Viti cave Vis creuse Tornillos huecos	Abmessungen - Dimensions - Dimensioni - Dimensions - Medidas [mm]								
	D	d	L	L ₁	L ₂	SW			
	M 10 x 1	12,1	24,5	19,5	8,5	17	03.3520-0302.1	390381	
		12,1	30,0	24,5	12,0	17	03.3520-0501.1	390382	
	M 12 x 1	14,1	28,0	22,5	10,0	17	03.3520-1003.1	390418	
	M 14 x 1,5	14,1	33,5	27,5	15,0	17	03.3520-2900.1	390390	
	M 10 x 1	12,1	34,0	19,0	8,0	17	03.3520-0600.1	390383	
Zwischenstücke Pipe adapters Raccordi intermedi Raccord intermédiaire Piezas intercaladas	Abmessungen - Dimensions - Dimensioni - Dimensions - Medidas [mm]								
	D	Gewinde Ausführung - Thread design - Esecuzione Filettata - Exécution filet - Ejecución de rosca	d	Gewinde Ausführung - Thread design - Esecuzione Filettata - Exécution filet - Ejecución de rosca	L	L ₁			SW
	M 10 x 1	A 2	M 10 x 1	A 2	24,0	8,5	14	03.3511-0800.1	390285 ①
	① In Sortimentbox 24.3516-0210.2 390553 enthalten. Included in collection 24.3516-0210.2 390553 . Contenuto nella scatola di assortimento 24.3516-0210.2 390553 . Include dans collection 24.3516-0210.2 390553 . Se incluye en caja de surtido 24.3516-0210.2 390553 .								
	M 12 x 1		M 12 x 1		35,0	15,0	12	03.3511-3800.1	390291
	M 12 x 1		M 10 x 1	A 2	28,0	15,3	17	03.3511-5200.1	390292
	M 12 x 1	A 1	M 12 x 1	A 1	29,0	-	17	03.3511-1000.1	390286
	M 12 x 1	A 1	M 12 x 1	A 1	29,0	19,0	19	03.3511-1100.1	390287

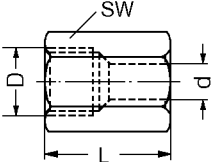
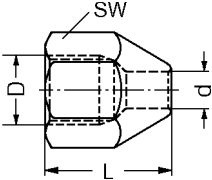

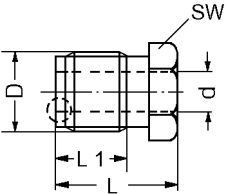
Armaturen

Fittings - Attrezzature - Composants et accessoires - Accesorios

Überwurfmutter Union nuts Dadi con risvolto Écrou-chapeau Tuerca de racor	Abmessungen - Dimensions - Dimensioni - Dimensions - Medidas [mm]						
	D	d	L	L ₁	für Bördel - for flare - bordatura tipo - pour colet - para reborde	SW	
	M 10 x 1	5,2	14,0		E	14	24.3516-0110.1 390549 ①
	<p>① In Sortimentbox 24.3516-0210.2 390553 enthalten. Included in collection 24.3516-0210.2 390553. Contenuto nella scatola di assortimento 24.3516-0210.2 390553. Incluse dans collection 24.3516-0210.2 390553. Se incluye en caja de surtido 24.3516-0210.2 390553.</p>						
	3/8" -24 UNF-2B	5,2	17,5		E	14	24.3516-0111.1 390550 ①
	<p>① In Sortimentbox 24.3516-0210.2 390553 enthalten. Included in collection 24.3516-0210.2 390553. Contenuto nella scatola di assortimento 24.3516-0210.2 390553. Incluse dans collection 24.3516-0210.2 390553. Se incluye en caja de surtido 24.3516-0210.2 390553.</p>						
Überwurfschrauben Union screws Viti con risvolto Vis chapeau Tornillos de racor	Abmessungen - Dimensions - Dimensioni - Dimensions - Medidas [mm]						
	D	d	L	L ₁	für Bördel - for flare - bordatura tipo - pour colet - para reborde	SW	
  E  F	M 10 x 1	4,75	17,0	11,0	E	10	03.3516-2300.1 390317
		5,2	16,7	9,5	E	10	24.3516-0020.1 390541 ②
		5,0	16,5	10,5	F	11	03.3516-3500.1 390318
		5,0	16,5	9,4	F	11	03.3516-0602.1 390412
		5,0	16,0	10,0	E	11	03.3516-0800.1 390313
		5,2	24,8	15,0	F	11	24.3516-0070.1 390546 ②
	M 10 x 1,25	5,2	19,5	13,5	F	10	24.3516-0050.1 390544 ②
		5,2	14,2	8,5	E	10	24.3516-0060.1 390545 ②
	M 12 x 1	6,0	18,0	11,4	E	12	24.3516-0080.1 390547
		5,0	20,0	13,0	F	12	24.3516-0090.1 390548
	3/8" -24 UNF-2A	5,2	18,0	12,0	E	10	24.3516-0040.1 390543 ②
		5,2	21,0	16,0	F	11	24.3516-0030.1 390542 ②
	<p>② In Sortimentbox 24.3516-0210.2 390553 enthalten. Included in collection 24.3516-0210.2 390553. Contenuto nella scatola di assortimento 24.3516-0210.2 390553. Incluse dans collection 24.3516-0210.2 390553. Se incluye en caja de surtido 24.3516-0210.2 390553.</p>						

Armaturen

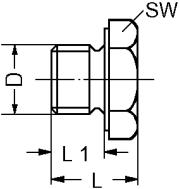
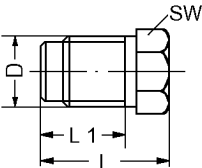
Fittings - Attrezzature - Composants et accessoires - Accesorios

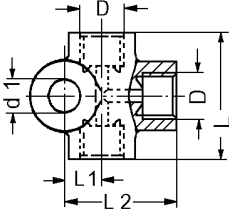
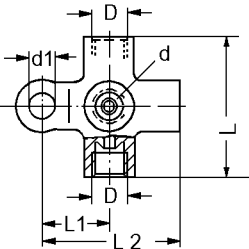
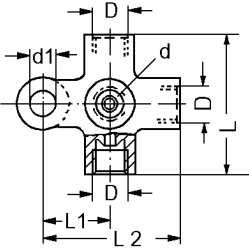
Verschlußstopfen Plugs Tappi Obturbateur Tapón de cierre	Abmessungen - Dimensions - Dimensioni - Dimensions - Medidas [mm]									
	D	d	L	L ₁	für Bördel - for flare - bordatura tipo - pour colet - para reborde	SW				
	M 10 x 1		12,5	7,5		14	03.3517-0100.1	390321		
	M 10 x 1		12,5	7,5		14	03.3517-0101.2	390322 ①		
① mit Dichtring (CU) with sealing ring (CU) avec joint d'étanchéité (CU) con anello di tenuta (CU) con junta (CU)										
	M 10 x 1		18,0	11,5	E + F	10	03.3517-5100.1	390326		
	M 12 x 1		20,0	13,0	E	12	03.3517-0300.1	390323		
Verteiler distributors ripartitore distributeur distribuidor	Abmessungen - Dimensions - Dimensioni - Dimensions - Medidas [mm]									
	D	Gewinde Ausführung - Thread design - Esecuzione Filettata - Exécution filet - Ejecución de rosca	d	Gewinde Ausführung - Thread design - Esecuzione Filettata - Exécution filet - Ejecución de rosca	L	L ₁	L ₂			d ₁
3 Anschlüsse - 3 Connections - 3 Attacchi - 3 Raccords - 3 Conexiones 	M 10 x 1	A 2			30,0	8,0	23,0	7,1	03.3513-0200.1	390297
		A 1			30,0	8,0	23,0	8,4	03.3513-1000.1	390299
	M 12 x 1	A 1			36,0	9,0	27,0	8,4	03.3513-2700.1	390300
		A 1			36,0	10,0	31,5	8,3	03.3513-0300.1	390298
3 Anschlüsse - 3 Connections - 3 Attacchi - 3 Raccords - 3 Conexiones 	M 12 x 1	A 1	M 12 x 1		34,0	19,0	-	10,5	03.3513-0109.2	390296
	① mit Entlüfterventil with bleeder valve con valvola di spurgo avec vis de purge con válvula de ventilador									
4 Anschlüsse - 4 Connections - 4 Attacchi - 4 Raccords - 4 Conexiones 	M 10 x 1	A 2	M 10 x 1	A 2	32,0	17,0	33,0	8,4	03.3514-2600.1	390306
		A 2	M 10 x 1 ①	A 2	32,0	17,0	33,0	8,4	03.3514-2600.2	390307
① mit Entlüfterventil with bleeder valve con valvola di spurgo avec vis de purge con válvula de ventilador										

Armaturen

Fittings - Attrezzature - Composants et accessoires - Accesorios

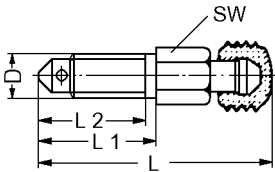
Entlüfterventil Bleeder valve Valvola di spurgo Vis de purge Válvula de ventilador	Abmessungen - Dimensions - Dimensioni - Dimensions - Medidas [mm]					
	D	L	L ₁	L ₂	SW	
 <p>Bestell-Nr. Staubkappe Part No. dust cap Codici ordinazione del parapolvere Référence capuchon de protection Referencia guardapolvo</p> <p>03.3590-0700.1 390456 03.3590-0701.1 390457 M</p>	M 6	31,5	16,0	12,0	7	03.3518-0100.2 390329
		31,5	16,0	12,0	7	03.3518-0102.2 390330 M
		41,0	22,0	12,0	7	03.3518-0200.2 390332
		29,0	13,5	12,0	7	03.3518-0300.2 390333
		29,0	13,5	12,0	7	03.3518-0302.2 390334 M
	M 7	33,0	16,5	15,0	7	03.3518-4200.2 390357
		41,0	22,0	15,5	7	03.3518-5900.2 390363
		22,5	12,5	11,0	7	03.3518-6800.2 390369 ①
		29,5	12,5	11,0	7	03.3518-6901.2 390370
	M 8	35,0	18,5	17,0	9	03.3518-0500.2 390337
		35,0	18,5	17,0	9	03.3518-0502.2 390339 M
		44,0	22,0	20,0	9	03.3518-0600.2 390340
		49,0	32,0	20,0	9	03.3518-0700.2 390342
		59,0	42,0	20,0	9	03.3518-0800.2 390343
		52,0	32,0	20,0	9	03.3518-6100.2 390364
		90,0	35,0	18,0	9	03.3518-8000.2 390373
	M 10 x 1	32,0	16,0	13,0	11	03.3518-0900.2 390345
		32,0	16,0	13,0	11	03.3518-0902.2 390346 M
		38,0	21,0	18,0	11	03.3518-1900.2 390354
		32,0	16,0	13,0	10	03.3518-5200.2 390358
	M 12 x 1	31,5	15,5	13,0	12	03.3518-1501.2 390349 ②
	M 12 x 1,5	43,0	26,0	24,0	14	03.3518-1300.2 390347
	7/16"-20 UNF-2A	40,0	23,0	21,0	11	03.3518-1700.2 390352

M nur für Mineralöl
only for mineral oil
solo per olio minerale
seulement pour huile minérale
sólo para aceite mineral

① mit Staubkappe **03.3590-0044.1 390455**
with dust cap **03.3590-0044.1 390455**
con parapolvere **03.3590-0044.1 390455**
avec capuchon de protection **03.3590-0044.1 390455**
con guardapolvo **03.3590-0044.1 390455**

② mit 60° Innenkegel
with 60° internal cone
con cono interno 60°
avec cône intérieur 60°
con cono interior 60°

Staubkappen
dust caps
parapolvere
capuchon de protection
guardapolvo

03.3590-0700.1 390456

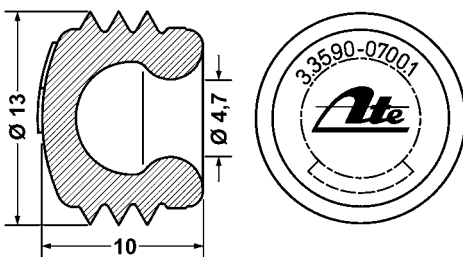

03.3590-0701.1 390457

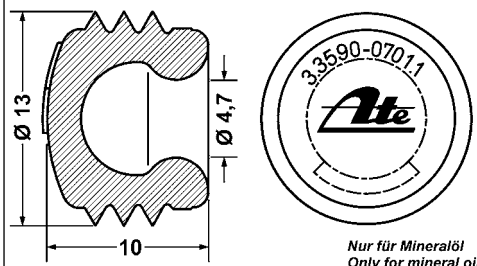



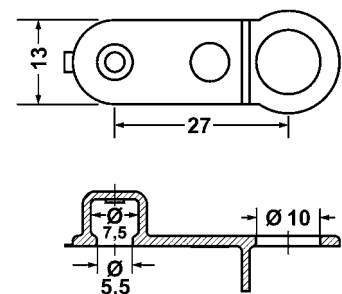

13.8190-0296.1 390409

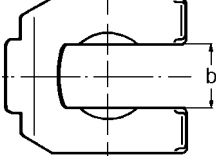
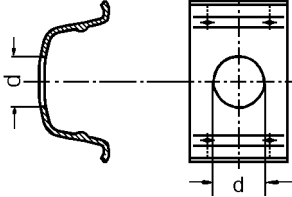
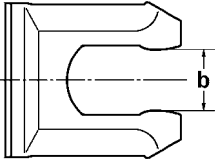

Armaturen

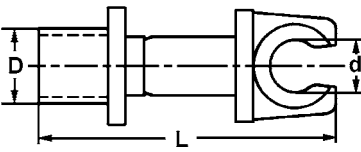
Fittings - Attrezzature - Composants et accessoires - Accesorios

Bremsschlauchhalter Hose spring-clamp Mollette per flessibile freni Ressort de retenue de flexible de frein Soporte manguera de freno	Abmessungen - Dimensions - Dimensioni - Dimensions - Medidas [mm]		
	b (d)	Blechstärke - Thickness of metal Spessore lamierino - Épaisseur de tôle - Espesor de chapa	
	14,0	1,00	03.5004-0101.1 990010
	14,0	1,75	03.5004-0401.1 990014
	12,0	1,00	24.5004-0001.1 390568 ②
	10,0	0,70	24.5004-0002.1 390569 ②
	② In Sortimentbox 24.3516-0230.2 390555 enthalten. Included in collection 24.3516-0230.2 390555. Contenuto nella scatola di assortimento 24.3516-0230.2 390555. Incluse dans collection 24.3516-0230.2 390555. Se incluye en caja de surtido 24.3516-0230.2 390555.		
	11,0	1,00	24.5004-0003.1 390570 ②
	② In Sortimentbox 24.3516-0230.2 390555 enthalten. Included in collection 24.3516-0230.2 390555. Contenuto nella scatola di assortimento 24.3516-0230.2 390555. Incluse dans collection 24.3516-0230.2 390555. Se incluye en caja de surtido 24.3516-0230.2 390555.		
Bremsrohrhalter Brake pipe line holder Supporto tubo freno Support de tuyau de freinage Soporte tubo de freno	Abmessungen - Dimensions - Dimensioni - Dimensions - Medidas [mm]		
	D	d	L
	6,3	4,7	28,0
Rohrleitungen DIN 74234 Pipe line DIN 74234 Tubazioni DIN 74234 Conduite tube DIN 74234 Tuberías DIN 74234	Abmessungen - Dimensions - Dimensioni - Dimensions - Medidas		
	Ø	L	
	4,75 mm	5,0 m	24.8134-0547.1 390571
	6,00 mm	5,0 m	24.8134-0560.1 390572
	8,00 mm	5,0 m	24.8134-0580.1 390573
	4,75 mm	31,5 m	24.8134-3147.1 390574

Armaturen

Fittings - Attrezzature - Composants et accessoires - Accesorios

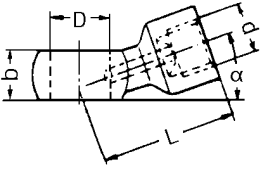
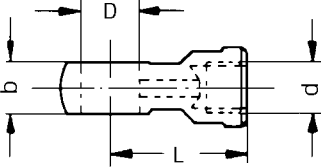
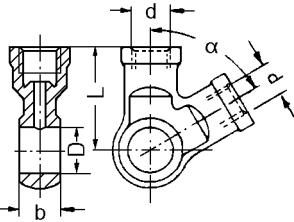
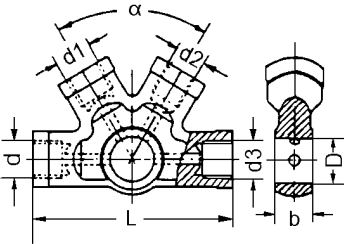
Ringstutzen Banjo fittings Raccordi anulari Manchon à oeillet Racores anulares	Abmessungen - Dimensions - Dimensioni - Dimensions - Medidas [mm]							
	D	d	Gewinde Ausführung - Thread design - Esecuzione filettata - Exécution filet - Ejecución de rosca	L	b	α		
1 Anschluss - 1 Connection - 1 Attaccho - 1 Raccord - 1 Conexión 	12,0	M 10 x 1	A 2	27,0	10,0	20°	03.3521-0100.1	390392
		M 10 x 1	A 2	30,0	10,0	30°	03.3521-0400.1	390394
	14,0	M 10 x 1	A 2	32,0	12,0	20°	03.3521-0800.1	390398
		M 12 x 1	A 1	32,0	12,0	20°	03.3521-0600.1	390395
1 Anschluss - 1 Connection - 1 Attaccho - 1 Raccord - 1 Conexión 	12,0	M 10 x 1	A 2	26,0	10,0		03.3521-0200.1	390393 ①
	① für Bremslichtschalter mit konischem Gewinde for stop-light switch with conical thread per interruttore luce di arresto con filettatura conica pour contacteur de stop avec filetage conique para interruptor de luz de freno con rosca cónica							
2 Anschlüsse - 2 Connections - 2 Attacchi - 2 Raccords - 2 Conexiones 	12,0	M 10 x 1	A 2	20,5	15,5	34°	03.3522-0200.1	390402
		M 12 x 1	A 1	32,0	12,0	60°	03.3522-0500.1	390403
	14,0	M 12 x 1	A 1	32,0	12,0	60°	03.3522-1100.1	390404
		M 10 x 1 ②	A 4					
② für Bremslichtschalter for stop-light switch per interruttore luce di arresto pour contacteur de stop para interruptor de luz de freno								
4 Anschlüsse - 4 Connections - 4 Attacchi - 4 Raccords - 4 Conexiones 	14,0	M 10 x 1	A 2	64,0	12,0	60°	03.3524-0300.1	390407

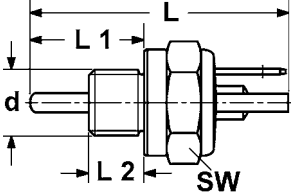
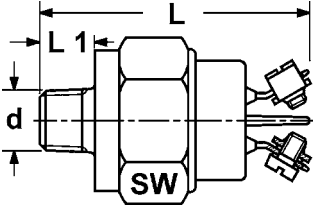
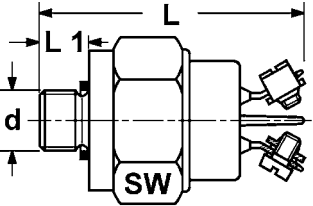
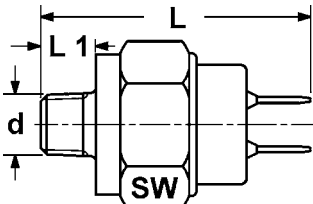
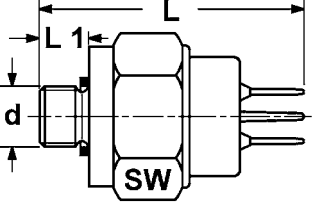
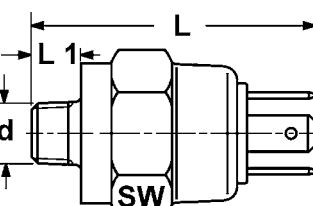

Armaturen

Fittings - Attrezzature - Composants et accessoires - Accesorios

Bremslichtschalter Stop-light switch Interruttore luce di arresto Contacteur de stop Interruptor de luz de freno	Abmessungen - Dimensions - Dimensioni - Dimensions - Medidas [mm]						
	Ausführung - Design - Esecuzione - Exécution - Ejecución	d	L	L ₁	L ₂		SW
	Steck-Anschluß Plug connection Attacco a spina Contact à fiches Enchufe de conexión	M 12 x 1	47,0	21,0	10,0	19	24.3525-9120.1 340015
	Klemm-Anschluß Clamp connection Collegamento a morsetto Borne de serrage Conexión por fijación	M 10 x 1	46,0	9,0		24	24.3526-0100.3 340017
		M 10 x 1	46,0	9,0		24	24.3526-0600.3 340027 M
	Klemm-Anschluß Clamp connection Collegamento a morsetto Borne de serrage Conexión por fijación	M 10 x 1	46,0	8,0		24	24.3526-0110.3 340018
		M 10 x 1	46,0	8,0		24	24.3526-0610.3 340030 M
	Steck-Anschluß Plug connection Attacco a spina Contact à fiches Enchufe de conexión	M 10 x 1	42,0	9,0		22	03.3526-2002.3 340010
	Steck-Anschluß Plug connection Attacco a spina Contact à fiches Enchufe de conexión	M 10 x 1	46,0	8,0		22	24.3526-0810.3 340037
	Steck-Anschluß Plug connection Attacco a spina Contact à fiches Enchufe de conexión	M 10 x 1	48,0	9,0		24	24.3526-0800.3 340033
		M 10 x 1	48,0	9,0		24	24.3526-1900.0 340038 M
		M 10 x 1	48,0	9,0		24	24.3526-2200.0 340039
M nur für Mineralöl - only for mineral oil - solo per olio minerale seulement pour huile minérale - sólo para aceite mineral							



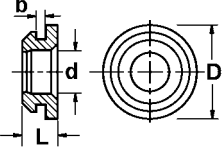
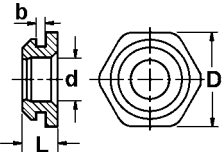

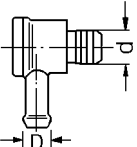
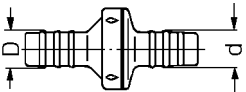



Armaturen

Fittings - Attrezzature - Composants et accessoires - Accesorios

Dichtung für Vakuum-Anschlußstück Hexagon for vacuum connection Guarnizione per pezzo di raccordo per depressione Hexagone pour raccord à dépression Retén para terminal de empalme al vacío	Abmessungen - Dimensions - Dimensioni - Dimensions - Medidas [mm]				
	L	b	D	d	
	9,5	1,5	28,0	13,0	03.7718-7203.1 390360
	9,5	2,5	28,0	13,0	03.7718-7202.1 390378
Vakuum-Rückschlagventil Vacuum check valve Valvola di non ritorno per depressione Soupape à dépression Válvula de retención al vacío	Abmessungen - Dimensions - Dimensioni - Dimensions - Medidas [mm]				
	L	b	D	d	
			12,4	16,5	03.6118-7305.2 990032
			10,5	16,5	03.6718-9931.2 990002
			11,8	11,8	24.7718-7301.2 990024
			13,0	13,0	03.6118-7307.2 990033

Armaturen

Fittings - Attrezzature - Composants et accessoires - Accesorios

<p>Prüfanschlüsse Testing connectors attacchi di prova connexion d'essai conexiones de ensayo</p>	<p>Für den festen Einbau in die Bremsanlage (z.B. anstelle eines Verteilerstückes). Druckprüfgeräte können hier direkt über die Anschlußschlauchleitung verbunden werden, ohne die Bremsanlage nachträglich zu entlüften. For permanent installation in the braking system (e.g. in the place of a distributor piece). The pressure testing units can be connected here directly to the connection hose line without having to bleed the braking system afterwards. Per montaggio fisso nell'impianto di frenatura (p.e. al posto di un ripartitore a più vie). Apparecchi prova pressione possono essere collegati direttamente tramite il tubo di collegamento, senza dover spurgare l'impianto freni a posteriori. Pour installation permanente dans le système de freinage (par ex: à la place d' une pièce de distribution). Les appareils de vérification de la pression peuvent être directement reliés à la connexion. Le système de freinage n' a pas besoin d' être purgé par la suite. Para el montaje fijo en la instalación de frenos (p. ej. en lugar de un distribuidor). Los controladores de presión no pueden unirse aquí directamente a través de la línea de conexión sin tener que airear posteriormente la instalación de frenos.</p>			
	 03.9305-0501.3 390481	 03.9305-0510.3 390483	 03.9305-0520.3 390485	 03.9305-0530.3 390486
<p>Anzahl der Befestigungslaschen Number of mounting links Numero delle fascette Nombre de trous de fixation Número de las bridas de fijación</p>	1	1	2	2
<p>Anzahl der Anschlüsse Number of connections Numero di attacchi Nombre de raccordement Número de conexiones</p>	2	3	2	2
<p>Gewinde Ausführung Thread design Esecuzione filettata Exécution filet Ejecución de rosca</p>	M 12 x 1 A1	M 12 x 1 A1	M 10 x 1 A2	M 12 x 1 A1
<p>Richtung des Prüfanschlusses zur Befestigungslasche Direction of the testing connector to the mounting link Direzione del raccordo di prova alla fascetta di fissaggio Nens du raccord d' essai par rapport aux trous de fixation Dirección de la conexión de ensayo a la brida de fijación</p>	horizontal orizzontale	vertical verticale	vertical verticale	vertical verticale
	 03.9305-0570.3 390488	 03.9305-0590.3 390489	 03.9305-0700.3 390491	
<p>Anzahl der Befestigungslaschen Number of mounting links Numero delle fascette Nombre de trous de fixation Número de las bridas de fijación</p>	1	1	-	
<p>Anzahl der Anschlüsse Number of connections Numero di attacchi Nombre de raccordement Número de conexiones</p>	3	3	1	
<p>Gewinde Ausführung Thread design Esecuzione filettata Exécution filet Ejecución de rosca</p>	M 12 x 1 A1	M 10 x 1 A2	M 10 x 1	
<p>Richtung des Prüfanschlusses zur Befestigungslasche Direction of the testing connector to the mounting link Direzione del raccordo di prova alla fascetta di fissaggio Nens du raccord d' essai par rapport aux trous de fixation Dirección de la conexión de ensayo a la brida de fijación</p>	vertical verticale	horizontal orizzontale	-	
<p>Prüfanschlüsse - Einzelteile Testing connectors - individual parts Attacchi di prova - pezzi singoli Connexion d' essai - pièces détachées Piezas sueltas - conexión de ensayo</p>	<p>03.9305-0502.0 390482 Schraubverschlusskappe Screw-type sealing cap Calotta per tappo filettato Capuchon à vis Tapa roscable</p>	<p>03.9305-0501.1 390480 Verbindungskette Connecting chain catena di collegamento chaîne de raccordement cadena de unión</p>	<p>03.3501-0021.1 390242 Gummidichtung in der Verschlusskappe Rubber seal in the sealing cap guarnizione in gomma nella calotta joint dans le capuchon junta de goma en la tapa de cierre</p>	

Armaturen

Fittings - Attrezzature - Composants et accessoires - Accesorios

Sortimente
Assortments
Assortimenti
Assortiments
Surtidos



<p>① M10x1 x 24,8 / SW11 Bördel F, Ø5mm ● 24.3516-0070.1 390546</p>	<p>① 3/8"-24 UNF x 18/SW10 Bördel E, Ø5mm ● 24.3516-0040.1 390543</p>	<p>② Schraubstutzen M10x1/M10x1 ■ 03.3510-0100.1 390271</p>	<p>① 3/8"-24 UNF x 21/SW11 Bördel F, Ø5mm ● 24.3516-0030.1 390542</p>	<p>1 24.3516-0210.2 390553 Armaturen Sortiment Fittings collection Serie di accessori Armatures collection Surtido de accesorios</p>
<p>① M10x1 x 16,7 / SW10 Bördel E, Ø5mm ● 24.3516-0020.1 390541</p>	<p>③ Überwurfmutter 3/8"-24UNFx17,5/SW11/E, Ø5mm ● 24.3516-0111.1 390550</p>	<p>① M10x1 x 16,7 / SW11 Bördel F, Ø5mm ● 24.3516-0010.1 390540</p>	<p>Rohrhalter ④ für 3/16" und 5mm ● 24.3590-0002.1 390567</p>	
<p>① M10x1,25 x 10,5 / SW10 Bördel F, Ø5mm ● 24.3516-0050.1 390544</p>	<p>① M10x1,25 x 14,2 / SW10 Bördel E, Ø5mm ● 24.3516-0060.1 390545</p>	<p>③ Überwurfmutter M10x1 x 13 / SW14 / E, Ø5mm ● 24.3516-0110.1 390549</p>	<p>⑤ Zwischenstück 2 x M10x1 x 24 SW14 ● 03.3511-0800.1 390285</p>	
<p>M6 x 1 x 29 SW7 ● 24.3518-0013.1 390558</p>	<p>M6 x 1 x 38 SW7 ● 24.3518-0012.1 390557</p>	<p>M7 x 1 x 26 SW7 ● 24.3518-0016.1 390561</p>	<p>M7 x 1 x 33 SW9 ● 24.3518-0017.1 390562</p>	<p>2 24.3516-0220.2 390554 Entlüfterschrauben Sortiment Bleeder valve collection Viti di spurgo assortimento Vis de purge collection Surtido de tornillos de ventilador</p>
<p>M7 x 1 x 38 SW7 ● 24.3518-0018.1 390563</p>	<p>M8 x 1,25 x 24,5 SW8 ● 24.3518-0021.1 390566</p>	<p>M8 x 1,25 x 32,5 SW9 ● 24.3518-0011.1 390556</p>	<p>M8 x 1,25 x 41,5 SW9 ● 24.3518-0019.1 390564</p>	
<p>M8 x 1,25 x 49 SW9 ● 24.3518-0020.1 390565</p>	<p>M10 x 1 x 30 SW11 ● 24.3518-0014.1 390559</p>	<p>M10 x 1 x 36 SW11 ● 24.3518-0015.1 390560</p>	<p>⑥ Staubkappe ■ 03.3590-0700.1 390456</p>	
<p>⑦ Bremschlauchhalter ● 24.5004-0001.1 390568</p>	<p>⑧ Haltefeder ● 24.5004-0002.1 390569</p>	<p>⑦ Bremschlauchhalter ● 24.5004-0003.1 390570</p>	<p>3 24.3516-0230.2 390555 Befestigungselemente Sortiment Fittings Collection Pezzi di fissaggio assortimento Fixation collection Surtido de elementos de fijación</p>	
<p>⑨ Sechskantschraube M12 x 1,5 x 45 ■ 13.8190-0242.1 990124</p>	<p>⑩ Sechskant-Paßschraube M12 x 1,5 - 10.9 ■ 13.8190-0239.1 990122</p>	<p>⑪ Senkschraube M6 x 14 -4.8 - H ● 41.1178-0815.1 990137</p>		
<p>⑨ Sechskantschraube M8 x 21 - 10.9 ● 11.8190-0125.1 990054</p>	<p>⑫ Zylinderschraube M6 x 10 -8.8 ● 41.1111-0811.3 990136</p>	<p>⑬ Sicherungsschraube M6 x 15,5 ● 24.8190-9015.1 990133</p>		
<p>① Bördel ② Schraubstutzen ③ Überwurfmutter ④ Rohrhalter für 3/16" und 5mm ⑤ Zwischenstück ⑥ Staubkappe ⑦ Bremschlauchhalter ⑧ Haltefeder ⑨ Sechskantschraube ⑩ Sechskant-Paßschraube ⑪ Senkschraube ⑫ Zylinderschraube ⑬ Sicherungsschraube ● Nachfüllbeutel 10 Stück ■ Einzelteil</p>	<p>Flare Screw adapters Union nut Pipe holder Pipe adapter Dust cap Hose spring-clamp Fixation spring Hexagon screw Hexagone-fitting screw Countersunk screw Cylinder screw Locking screw Refillbag with 10 pieces Single part</p>	<p>Bordatura tipo Raccordi filettati Dadi con risvolto Supporto Raccordi intermedi Parapolvere Mollette per flessibile freni Molla di ritegno Vite a testa esagonale Vite calibrata a testa esagonale Vite a testa svasata Vite a testa cilindrica Vite autobloccante Sacchetto di riassortimento 10 pezzi Pezzo singolo</p>	<p>Colet Raccord fiteté Écrou-chapeau Support de tube pour 3/16" et 5mm Raccord intermédiaire Capuchon de protection Ressort de retenue de flexible de frein Ressort d'arrêt Boulon hexagonal Boulon hexagonal-vis Vis a tête conique Vis cylindrique Vis d'appui Sac de remplissage à 10 pièces Pièces dé tachées</p>	<p>Reborde Racores Tuerca de racor Soporte de tubo para 3/16" y 5mm Piezas intercaladas Guardapolvo Soporte manguera de freno Resorte de retención Resorte de retención Tornillo hexagonal Tornillo calibrado hexagonal Tornillo cilíndrico Tornillo de seguridad Bolsa de relleno con 10 piezas Pieza suelta</p>



A large rectangular area containing 30 horizontal lines, intended for writing or drawing.



A large rectangular area containing 30 horizontal lines, intended for writing or drawing.



- Ⓧ **Bremsgeräte komplett**
- Ⓧ **Booster units complete**
- Ⓧ **Servo-freins complets**
- Ⓧ **Servofreno completo**

Bremsgeräte komplett

**Booster units complete - Servofreni completi -
Servo-freins complets - Servofreno completo**

● Die Nr. befindet sich auf dem im Fahrzeug eingebautem Aggregat.
the number is on the unit build in the car
il numero si trova sull'aggregato montato nella macchina
le numéro se trouve sur la pièce montée dans le véhicule
el n° se encuentra en el equipo montado en el vehículo



03.6121-0501.4	03.3508-0264.3	310009	Behälter
03.6122-0010.4	03.3508-8302.3	310046	Behälter
03.6122-0017.4	03.3508-8302.3	310046	Behälter
03.6122-0018.4	03.3508-8302.3	310046	Behälter
03.6122-0601.4	03.3508-8302.3	310046	Behälter
03.6122-1002.4	03.3508-8302.3	310046	Behälter
03.6122-1006.4	03.3508-8302.3	310046	Behälter
03.6122-1401.4	03.3508-8302.3	310046	Behälter
03.6122-2001.4	03.2119-6207.3	10060	THz 19,05
03.6122-2002.4	03.2119-6207.3	10060	THz 19,05
03.6122-2003.4	03.2119-6207.3	10060	THz 19,05
03.6122-2102.4	03.3508-8302.3	310046	Behälter
03.6122-2401.4	03.2119-0525.3	10046	THz 19,05 + Behälter
03.6122-2402.4	03.2120-0148.3	10070	THz 20,64 + Behälter
03.6122-2407.4	03.2120-0148.3	10070	THz 20,64 + Behälter
03.6127-0001.4	03.2123-6802.3	10186	THz 23,81
03.6127-0301.4	03.2123-6802.3	10186	THz 23,81
03.6127-0801.4	03.2122-0142.3 03.3558-0676.3	10128 310077	THz 22,20 Behälter + WE
03.6127-0804.4	03.3558-0676.3	310077	Behälter + WE
03.6132-0702.4	03.3508-8302.3	310046	Behälter
03.6132-1103.4	03.2120-0148.3	10070	THz 20,64 + Behälter
03.6132-1401.4	03.3508-8302.3	310046	Behälter
03.6132-1501.4	03.2122-0142.3 03.3558-0676.3	10128 310077	THz 22,20 Behälter + WE
03.6132-1502.4	03.2122-0142.3 03.3558-0676.3	10128 310077	THz 22,20 Behälter + WE
03.6132-1701.4	03.2123-1003.3	10175	THz 23,81
03.6132-1901.4	03.2120-5503.3	10124	THz 20,64 + Behälter
03.6132-2001.4	03.3508-8302.3	310046	Behälter
03.6132-2701.4	03.3508-7504.3	310045	Behälter
03.6132-2901.4	03.2120-0148.3	10070	THz 20,64 + Behälter

03.6132-3401.4	03.3508-8302.3	310046	Behälter
03.6132-3905.4	03.3508-7504.3	310045	Behälter
03.6132-3907.4	03.2120-1531.3 03.3508-7504.3	10092 310045	THz 20,64 Behälter
03.6132-3908.4	03.3508-7504.3	310045	Behälter
03.6132-3912.4	03.2120-1531.3	10092	THz 20,64
03.6132-4201.4	03.2120-0148.3	10070	THz 20,64 + Behälter
03.6132-4202.4	03.2120-0148.3	10070	THz 20,64 + Behälter
03.6132-4203.4	03.2120-0148.3	10070	THz 20,64 + Behälter
03.6132-4207.4	03.2120-0148.3	10070	THz 20,64 + Behälter
03.6132-4401.4	03.2120-5503.3	10124	THz 20,64 + Behälter
03.6132-4601.4	03.3508-7504.3	310045	Behälter
03.6132-4703.4	03.3508-8302.3	310046	Behälter
03.6132-4704.4	03.3508-8302.3	310046	Behälter
03.6132-4901.4	03.3508-7504.3	310045	Behälter
03.6132-5201.4	03.3508-7504.3	310045	Behälter
03.6132-5405.4	03.2120-0538.3	10077	THz 20,64
03.6132-5501.4	03.2120-1531.3 03.3508-7504.3	10092 310045	THz 20,64 Behälter
03.6132-5502.4	03.3508-7504.3	310045	Behälter
03.6132-5701.4	03.2120-1531.3	10092	THz 20,64
03.6132-5802.4	03.3508-7504.3	310045	Behälter
03.6132-6301.4	03.2120-2598.3	10116	THz 20,64
03.6132-6302.4	03.2120-2598.3	10116	THz 20,64
03.6132-6304.4	03.2120-2598.3	10116	THz 20,64
03.6132-6305.4	03.2120-2598.3	10116	THz 20,64
03.6132-6306.4	03.2120-2598.3	10116	THz 20,64
03.6132-6501.4	03.2120-1531.3	10092	THz 20,64
03.6132-6512.4	03.2120-1531.3	10092	THz 20,64
03.6132-6515.4	03.2120-1491.3	10089	THz 20,64 + WE
03.6132-6706.4	03.2120-1491.3	10089	THz 20,64 + WE
03.6142-0301.4	03.3508-8302.3	310046	Behälter

Bremsgeräte komplett

Booster units complete - Servofreni completi - Servo-freins complets - Servofreno completo

● Die Nr. befindet sich auf dem im Fahrzeug eingebautem Aggregat.
the number is on the unit build in the car
il numero si trova sull'aggregato montato nella macchina
le numéro se trouve sur la pièce montée dans le véhicule
el n° se encuentra en el equipo montado en el vehículo



03.6142-0701.4	03.3508-8302.3	310046	Behälter	03.6142-4702.4	03.2122-4902.3	10144	THz 22,20
03.6142-1201.4	03.2123-2604.3	10178	THz 23,81 + WE	03.6142-4704.4	03.2122-4902.3	10144	THz 22,20
03.6142-1202.4	03.2123-2604.3	10178	THz 23,81 + WE	03.6142-4801.4	03.2123-6207.3	10185	THz 23,81
03.6142-1205.4	03.2123-2604.3	10178	THz 23,81 + WE		03.3508-7504.3	310045	Behälter
03.6142-1502.4	03.2122-2202.3	10140	THz 22,20	03.6142-4802.4	03.3508-7504.3	310045	Behälter
03.6142-1701.4	03.2119-6207.3	10060	THz 19,05	03.6142-4803.4	03.3508-7504.3	310045	Behälter
	03.3558-0676.3	310077	Behälter + WE	03.6142-5201.4	03.2123-6207.3	10185	THz 23,81
03.6142-1703.4	03.2120-4504.3	10123	THz 20,64		03.3508-7504.3	310045	Behälter
	03.3558-0676.3	310077	Behälter + WE	03.6142-5202.4	03.3508-7504.3	310045	Behälter
03.6142-1704.4	03.2120-4504.3	10123	THz 20,64	03.6142-5203.4	03.3508-7504.3	310045	Behälter
	03.3558-0676.3	310077	Behälter + WE	03.6142-5205.4	03.2123-4911.3	10182	THz 23,81
03.6142-2101.4	03.2122-2202.3	10140	THz 22,20	03.6142-5301.4	03.3508-8302.3	310046	Behälter
03.6142-2402.4	03.2123-6207.3	10185	THz 23,81	03.6142-5502.4	03.3508-7504.3	310045	Behälter
	03.3508-7504.3	310045	Behälter	03.6142-6803.4	03.2122-4902.3	10144	THz 22,20
03.6142-2403.4	03.3508-7504.3	310045	Behälter	03.6142-7203.4	03.2120-1491.3	10089	THz 20,64 + WE
03.6142-3001.4	03.2120-5503.3	10124	THz 20,64 + Behälter	03.6142-7204.4	03.2120-1491.3	10089	THz 20,64 + WE
03.6142-3201.4	03.6058-0301.3	320072	BR 25/5 (3)	03.6142-7205.4	03.2120-1491.3	10089	THz 20,64 + WE
03.6142-3203.4	03.6058-0301.3	320072	BR 25/5 (3)	03.6142-7301.4	03.2120-1491.3	10089	THz 20,64 + WE
03.6142-3204.4	03.6058-0301.3	320072	BR 25/5 (3)	03.6142-7302.4	03.2120-1491.3	10089	THz 20,64 + WE
03.6142-3205.4	03.6058-0301.3	320072	BR 25/5 (3)	03.6142-7303.4	03.2120-1491.3	10089	THz 20,64 + WE
03.6142-3301.4	03.2123-6207.3	10185	THz 23,81	03.6147-0401.4	03.2125-1102.3	10202	THz 25,40
	03.3508-7504.3	310045	Behälter		03.3508-3600.3	310030	Behälter
03.6142-3302.4	03.3508-7504.3	310045	Behälter	03.6147-0501.4	03.2125-1102.3	10202	THz 25,40
03.6142-4401.4	03.2123-2604.3	10178	THz 23,81 + WE	03.6147-1101.4	03.2125-1302.3	10203	THz 25,40
03.6142-4601.4	03.2122-0142.3	10128	THz 22,20	03.6147-1102.4	03.2125-1302.3	10203	THz 25,40
	03.3558-0676.3	310077	Behälter + WE	03.6147-1103.4	03.2125-1302.3	10203	THz 25,40
03.6142-4602.4	03.2122-0142.3	10128	THz 22,20	03.6147-1301.4	03.2123-6802.3	10186	THz 23,81
	03.3558-0676.3	310077	Behälter + WE	03.6147-1703.4	03.2125-1302.3	10203	THz 25,40
03.6142-4603.4	03.2122-0142.3	10128	THz 22,20	03.6147-2402.4	03.2123-8611.3	10195	THz 23,81
	03.3558-0676.3	310077	Behälter + WE	03.6152-0206.4	03.2123-3402.3	10181	THz 23,81
03.6142-4604.4	03.2122-0142.3	10128	THz 22,20		03.3508-8753.3	310049	Behälter + WE
	03.3558-0676.3	310077	Behälter + WE		03.6850-0202.4	300043	9"
03.6142-4605.4	03.2122-0142.3	10128	THz 22,20	03.6152-0209.4	03.2023-0166.3	10015	THz 23,81/19,05
	03.3558-0676.3	310077	Behälter + WE		03.6850-0202.4	300043	9"
03.6142-4701.4	03.2122-4902.3	10144	THz 22,20				

Bremsgeräte komplett

**Booster units complete - Servofreni completi -
Servo-freins complets - Servofreno completo**

● Die Nr. befindet sich auf dem im Fahrzeug eingebautem Aggregat.
the number is on the unit build in the car
il numero si trova sull'aggregato montato nella macchina
le numéro se trouve sur la pièce montée dans le véhicule
el n° se encuentra en el equipo montado en el vehículo



03.6152-0210.4	03.2023-0166.3 03.6850-0202.4	10015 300043	THz 23,81/19,05 9"
03.6152-0401.4	03.2122-6202.3	10148	THz 22,20
03.6152-0601.4	03.3508-8302.3	310046	Behälter
03.6152-0701.4	03.2123-6802.3	10186	THz 23,81
03.6152-0702.4	03.2122-6202.3	10148	THz 22,20
03.6152-0703.4	03.2122-6202.3	10148	THz 22,20
03.6152-0803.4	03.2123-6207.3 03.3508-7504.3	10185 310045	THz 23,81 Behälter
03.6152-1002.4	03.2123-3302.3	10180	THz 23,81
03.6152-1101.4	03.3508-8302.3	310046	Behälter
03.6152-1401.4	03.2123-6802.3	10186	THz 23,81
03.6152-1502.4	03.2123-3302.3	10180	THz 23,81
03.6152-1701.4	03.2123-6207.3 03.3508-7504.3	10185 310045	THz 23,81 Behälter
03.6152-1801.4	03.2122-0142.3 03.3558-0676.3	10128 310077	THz 22,20 Behälter + WE
03.6152-2001.4	03.2123-6207.3 03.3508-7504.3	10185 310045	THz 23,81 Behälter
03.6152-2002.4	03.3508-7504.3	310045	Behälter
03.6152-2003.4	03.2123-4911.3	10182	THz 23,81
03.6152-2101.4	03.3508-8302.3	310046	Behälter
03.6157-0201.4	03.3508-8302.3	310046	Behälter
03.6157-0301.4	03.2123-1003.3 03.3508-8753.3 03.6855-1202.4	10175 310049 300056	THz 23,81 Behälter + WE 9" Tandem
03.6157-0302.4	03.2123-1003.3 03.3508-8753.3 03.6855-1202.4	10175 310049 300056	THz 23,81 Behälter + WE 9" Tandem
03.6157-0303.4	03.2123-1003.3 03.3508-8753.3 03.6855-1202.4	10175 310049 300056	THz 23,81 Behälter + WE 9" Tandem
03.6157-0304.4	03.2123-3402.3 03.3508-8753.3 03.6855-1202.4	10181 310049 300056	THz 23,81 Behälter + WE 9" Tandem
03.6157-0305.4	03.2123-1003.3 03.3508-8753.3 03.6855-1202.4	10175 310049 300056	THz 23,81 Behälter + WE 9" Tandem

03.6157-0306.4	03.2123-3402.3 03.3508-8753.3 03.6855-1202.4	10181 310049 300056	THz 23,81 Behälter + WE 9" Tandem
03.6157-0307.4	03.2023-0112.3 03.6855-1202.4	10013 300056	THz 23,81/19,05 9" Tandem
03.6157-0308.4	03.2023-0166.3 03.6855-1202.4	10015 300056	THz 23,81/19,05 9" Tandem
03.6157-0309.4	03.2023-0112.3 03.6855-1202.4	10013 300056	THz 23,81/19,05 9" Tandem
03.6157-0310.4	03.2023-0166.3 03.6855-1202.4	10015 300056	THz 23,81/19,05 9" Tandem
03.6157-0501.4	03.2123-7002.3	10187	THz 23,81
03.6157-0503.4	03.2123-7002.3	10187	THz 23,81
03.6197-1501.4	03.3508-8302.3	310046	Behälter
03.6197-2101.4	03.3508-8302.3	310046	Behälter
03.6197-2201.4	03.3508-8302.3	310046	Behälter
03.6197-2202.4	03.3508-8302.3	310046	Behälter
03.6197-2203.4	03.3508-8302.3	310046	Behälter
03.6197-2204.4	03.3508-8302.3	310046	Behälter
03.6197-2801.4	03.3508-8302.3	310046	Behälter
03.6197-3301.4	03.3508-8302.3	310046	Behälter
03.6197-3302.4	03.3508-8302.3	310046	Behälter
03.6732-0101.4	03.2120-2031.3	10106	THz 20,64
03.6732-0201.4	03.2120-2031.3	10106	THz 20,64
03.6732-0203.4	03.2120-2031.3	10106	THz 20,64
03.6732-0401.4	03.2120-2031.3	10106	THz 20,64
03.6732-0503.4	03.2120-2598.3	10116	THz 20,64
03.6732-0504.4	03.2120-2598.3	10116	THz 20,64
03.6732-0601.4	03.2120-2031.3	10106	THz 20,64
03.6732-0901.4	03.2119-3389.3	10057	THz 19,05
03.6732-1001.4	03.2119-3389.3	10057	THz 19,05
03.6732-1101.4	03.2119-3389.3	10057	THz 19,05
03.6732-1103.4	03.2119-3389.3	10057	THz 19,05
03.6732-1201.4	03.2119-3389.3	10057	THz 19,05



Bremsgeräte komplett

Booster units complete - Servofreni completi - Servo-freins complets - Servofreno completo

● Die Nr. befindet sich auf dem im Fahrzeug eingebautem Aggregat.
the number is on the unit build in the car
il numero si trova sull'aggregato montato nella macchina
le numéro se trouve sur la pièce montée dans le véhicule
el n° se encuentra en el equipo montado en el vehículo



03.6732-3301.4	03.2119-3389.3	10057	THz 19,05	03.6742-0302.4	03.2120-2598.3	10116	THz 20,64
03.6732-3501.4	03.2119-3389.3	10057	THz 19,05	03.6742-0401.4	03.2120-2598.3	10116	THz 20,64
03.6742-0101.4	03.2120-2598.3	10116	THz 20,64	03.6742-0402.4	03.2120-2598.3	10116	THz 20,64
03.6742-0102.4	03.2120-2598.3	10116	THz 20,64	03.6742-0404.4	03.2120-2598.3	10116	THz 20,64
03.6742-0103.4	03.2120-2598.3	10116	THz 20,64	03.6742-0406.4	03.2120-2598.3	10116	THz 20,64
03.6742-0104.4	03.2120-2598.3	10116	THz 20,64	03.6742-0407.4	03.2120-2598.3	10116	THz 20,64
03.6742-0105.4	03.2120-2598.3	10116	THz 20,64	03.6742-0409.4	03.2120-2597.3	10115	THz 20,64
03.6742-0106.4	03.2120-2598.3	10116	THz 20,64	03.6742-0410.4	03.2120-2597.3	10115	THz 20,64
03.6742-0107.4	03.2120-2598.3	10116	THz 20,64	03.6742-0411.4	03.2120-2597.3	10115	THz 20,64
03.6742-0108.4	03.2120-2598.3	10116	THz 20,64	03.6742-0412.4	03.2120-2597.3	10115	THz 20,64
03.6742-0109.4	03.2120-2598.3	10116	THz 20,64	03.6742-0413.4	03.2120-2597.3	10115	THz 20,64
03.6742-0110.4	03.2120-2598.3	10116	THz 20,64	03.6742-0414.4	03.2120-2597.3	10115	THz 20,64
03.6742-0111.4	03.2120-2598.3	10116	THz 20,64	03.6742-0415.4	03.2120-2597.3	10115	THz 20,64
03.6742-0112.4	03.2120-2598.3	10116	THz 20,64	03.6742-0416.4	03.2120-2597.3	10115	THz 20,64
03.6742-0113.4	03.2120-2598.3	10116	THz 20,64	03.6742-0419.4	03.2120-2597.3	10115	THz 20,64
03.6742-0114.4	03.2120-2598.3	10116	THz 20,64	03.6742-0420.4	03.2120-2597.3	10115	THz 20,64
03.6742-0115.4	03.2120-2598.3	10116	THz 20,64	03.6742-0421.4	03.2120-2597.3	10115	THz 20,64
03.6742-0116.4	03.2120-2598.3	10116	THz 20,64	03.6742-0422.4	03.2120-2597.3	10115	THz 20,64
03.6742-0117.4	03.2120-2598.3	10116	THz 20,64	03.6742-0423.4	03.2120-2597.3	10115	THz 20,64
03.6742-0118.4	03.2120-2598.3	10116	THz 20,64	03.6742-0601.4	03.2122-0142.3 03.3558-0676.3	10128 310077	THz 22,20 Behälter + WE
03.6742-0119.4	03.2120-2597.3	10115	THz 20,64	03.6742-0701.4	03.2119-3389.3	10057	THz 19,05
03.6742-0120.4	03.2120-2597.3	10115	THz 20,64	03.6742-1201.4	03.2119-3389.3	10057	THz 19,05
03.6742-0121.4	03.2120-2597.3	10115	THz 20,64	03.6742-1501.4	03.2120-2031.3	10106	THz 20,64
03.6742-0122.4	03.2120-2597.3	10115	THz 20,64	03.6742-1701.4	03.2120-2031.3	10106	THz 20,64
03.6742-0123.4	03.2120-2597.3	10115	THz 20,64	03.6742-1801.4	03.2119-3391.3	10058	THz 19,05
03.6742-0124.4	03.2120-2597.3	10115	THz 20,64	03.6742-2001.4	03.2120-1897.3	10103	THz 20,64
03.6742-0201.4	03.2123-4911.3	10182	THz 23,81	03.6752-0201.4	03.2120-2031.3 03.6750-0202.4	10106 300033	THz 20,64 9"
03.6742-0202.4	03.2120-0538.3	10077	THz 20,64	03.6752-0302.4	03.2120-2031.3	10106	THz 20,64
03.6742-0203.4	03.2120-2598.3	10116	THz 20,64	03.6752-0305.4	03.2120-2331.3	10110	THz 20,64
03.6742-0204.4	03.2120-2598.3	10116	THz 20,64	03.6752-0306.4	03.2120-2031.3	10106	THz 20,64
03.6742-0301.4	03.2120-2598.3	10116	THz 20,64				

Bremsgeräte komplett

**Booster units complete - Servofreni completi -
Servo-freins complets - Servofreno completo**

● Die Nr. befindet sich auf dem im Fahrzeug eingebautem Aggregat.
the number is on the unit build in the car
il numero si trova sull'aggregato montato nella macchina
le numéro se trouve sur la pièce montée dans le véhicule
el n° se encuentra en el equipo montado en el vehículo



03.6752-0501.4	03.2120-2598.3	10116	THz 20,64
03.6752-0502.4	03.2120-2598.3	10116	THz 20,64
03.6752-0505.4	03.2120-2597.3	10115	THz 20,64
03.6752-0506.4	03.2120-2597.3	10115	THz 20,64
03.6752-0507.4	03.2120-2597.3	10115	THz 20,64
03.6752-0508.4	03.2120-2597.3	10115	THz 20,64
03.6752-0801.4	03.2122-9812.3	10161	THz 22,20
03.6752-0902.4	03.2120-2331.3	10110	THz 20,64
	03.7750-0302.4	300071	9"
03.6752-0903.4	03.2120-2191.3	10108	THz 20,64
	03.7750-0302.4	300071	9"
03.6752-1002.4	03.2120-2682.3	10118	THz 20,64
03.6752-1101.4	03.2120-2331.3	10110	THz 20,64
03.6752-1102.4	03.2122-9612.3	10159	THz 22,20
03.6752-1201.4	03.2120-2331.3	10110	THz 20,64
03.6752-1301.4	03.2126-0512.3	10217	THz 26,99
03.6752-1401.4	03.2120-2331.3	10110	THz 20,64
03.6752-1607.4	03.2120-2597.3	10115	THz 20,64
03.6752-1608.4	03.2120-2597.3	10115	THz 20,64
03.6752-1609.4	03.2120-2597.3	10115	THz 20,64
03.6752-1610.4	03.2120-2597.3	10115	THz 20,64
03.6752-1611.4	03.2120-2597.3	10115	THz 20,64
03.6752-1703.4	03.2120-2597.3	10115	THz 20,64
03.6752-1704.4	03.2120-2597.3	10115	THz 20,64
03.6752-1901.4	03.2120-2031.3	10106	THz 20,64
03.6752-2101.4	03.2120-2682.3	10118	THz 20,64
03.6752-2502.4	03.2122-9631.3	10160	THz 22,20
03.6752-2601.4	03.2122-9631.3	10160	THz 22,20
03.6752-2901.4	03.6750-2902.4	300037	9"
03.6752-2902.4	03.2122-9631.3	10160	THz 22,20
	03.6750-2902.4	300037	9"
03.6752-2903.4	03.2120-2682.3	10118	THz 20,64
	03.6750-2902.4	300037	9"

03.6752-3103.4	03.2120-2682.3	10118	THz 20,64
03.6752-3201.4	03.2120-2031.3	10106	THz 20,64
03.6752-3501.4	03.2120-2682.3	10118	THz 20,64
03.6752-3601.4	03.2120-2682.3	10118	THz 20,64
03.6752-3701.4	03.2122-0626.3	10539	THz 22,20
03.6752-3702.4	03.2122-9631.3	10160	THz 22,20
03.6757-1004.4	03.2023-0166.3	10015	THz 23,81/19,05
	03.6855-1202.4	300056	9" Tandem
03.6762-0101.4	03.2123-8311.3	10192	THz 23,81
	03.7760-0902.4	300088	10"
03.6762-0102.4	03.2122-6911.3	10153	THz 22,20
	03.7760-0902.4	300088	10"
03.6762-0103.4	03.2122-6911.3	10153	THz 22,20
	03.7760-0902.4	300088	10"
03.6762-0104.4	03.7760-0902.4	300088	10"
03.6762-0105.4	03.2020-0402.3	10001	THz 20,64/19,05
	03.7760-0902.4	300088	10"
03.6762-0106.4	03.2123-8311.3	10192	THz 23,81
	03.7760-0902.4	300088	10"
03.6762-0107.4	03.7760-0902.4	300088	10"
03.6762-0108.4	03.2120-2082.3	10107	THz 20,64
	03.7760-0902.4	300088	10"
03.6762-0110.4	03.2120-1802.3	10099	THz 20,64
	03.7760-0902.4	300088	10"
03.6762-0111.4	03.2020-0402.3	10001	THz 20,64/19,05
	03.7760-0902.4	300088	10"
03.6762-0112.4	03.2120-1802.3	10099	THz 20,64
	03.7760-0902.4	300088	10"
03.6762-0114.4	03.2020-0402.3	10001	THz 20,64/19,05
	03.7760-0902.4	300088	10"
03.6762-0115.4	03.2120-2082.3	10107	THz 20,64
	03.7760-0902.4	300088	10"
03.6762-0116.4	03.2123-8311.3	10192	THz 23,81
	03.7760-0902.4	300088	10"
03.6762-0117.4	03.7760-0902.4	300088	10"
03.6762-0118.4	03.2123-8311.3	10192	THz 23,81
	03.7760-0902.4	300088	10"
03.6762-0312.4	03.7760-2702.4	300090	10"



Bremsgeräte komplett

Booster units complete - Servofreni completi - Servo-freins complets - Servofreno completo

● Die Nr. befindet sich auf dem im Fahrzeug eingebautem Aggregat.
the number is on the unit build in the car
il numero si trova sull'aggregato montato nella macchina
le numéro se trouve sur la pièce montée dans le véhicule
el n° se encuentra en el equipo montado en el vehículo



03.6762-0401.4	03.2023-0825.3 03.7760-2702.4	10028 300090	THz 23,81/19,05 10"	03.6842-0301.4	03.2120-0622.3	10079	THz 20,64
03.6762-0402.4	03.2023-0825.3 03.7760-2702.4	10028 300090	THz 23,81/19,05 10"	03.6842-0601.4	03.2120-0538.3	10077	THz 20,64
03.6762-0501.4	03.2022-0702.3	10007	THz 22,20/19,05	03.6842-0701.4	03.2120-0538.3	10077	THz 20,64
03.6762-0502.4	03.2022-0702.3	10007	THz 22,20/19,05	03.6842-0702.4	03.2120-0538.3	10077	THz 20,64
03.6762-0503.4	03.2022-0702.3	10007	THz 22,20/19,05	03.6842-0703.4	03.2123-4911.3	10182	THz 23,81
03.6762-0504.4	03.2022-1402.3	10010	THz 22,20/19,05	03.6842-0704.4	03.2120-0538.3	10077	THz 20,64
03.6762-0505.4	03.2022-1402.3	10010	THz 22,20/19,05	03.6842-1001.4	03.2123-0162.3	10162	THz 23,81 + WE
03.6762-0508.4	03.2022-1602.3	10011	THz 22,20/19,05	03.6842-1002.4	03.2120-2462.3	10113	THz 20,64 + WE
03.6762-0509.4	03.2022-1602.3	10011	THz 22,20/19,05	03.6842-1003.4	03.2123-0162.3	10162	THz 23,81 + WE
03.6762-0519.4	03.2022-1402.3	10010	THz 22,20/19,05	03.6842-1401.4	03.2120-0151.3	10071	THz 20,64
03.6762-0520.4	03.2022-1602.3	10011	THz 22,20/19,05	03.6842-1605.4	03.2120-2598.3	10116	THz 20,64
03.6762-0522.4	03.2022-0702.3	10007	THz 22,20/19,05	03.6842-1606.4	03.2120-2598.3	10116	THz 20,64
03.6762-0523.4	03.2022-1402.3	10010	THz 22,20/19,05	03.6842-1607.4	03.2120-2598.3	10116	THz 20,64
03.6762-0525.4	03.2022-1602.3	10011	THz 22,20/19,05	03.6842-1608.4	03.2120-2598.3	10116	THz 20,64
03.6762-0601.4	03.2020-0402.3 03.7760-0902.4	10001 300088	THz 20,64/19,05 10"	03.6842-1609.4	03.2120-2598.3	10116	THz 20,64
03.6762-0602.4	03.2120-1802.3 03.7760-0902.4	10099 300088	THz 20,64 10"	03.6842-1610.4	03.2120-2598.3	10116	THz 20,64
03.6832-0101.4	03.2120-3412.3	10121	THz 20,64	03.6842-1611.4	03.2120-2598.3	10116	THz 20,64
03.6832-0104.4	03.6058-0501.3	320074	BR 25/5 (4)	03.6842-1612.4	03.2120-2598.3	10116	THz 20,64
03.6832-0201.4	03.2120-1531.3	10092	THz 20,64	03.6842-1613.4	03.2120-2598.3	10116	THz 20,64
03.6832-0202.4	03.2120-1531.3	10092	THz 20,64	03.6842-1614.4	03.2120-2598.3	10116	THz 20,64
03.6832-0601.4	03.2120-0322.3	10074	THz 20,64 + WE	03.6842-3401.4	03.2123-0162.3	10162	THz 23,81 + WE
03.6832-0701.4	03.2120-2462.3	10113	THz 20,64 + WE	03.6852-0201.4	03.2123-1003.3 03.3508-8753.3 03.6850-0202.4	10175 310049 300043	THz 23,81 Behälter + WE 9"
03.6832-1001.4	03.2120-2462.3	10113	THz 20,64 + WE	03.6852-0202.4	03.2123-3402.3 03.3508-8753.3 03.6850-0202.4	10181 310049 300043	THz 23,81 Behälter + WE 9"
03.6832-1102.4	03.2120-0148.3	10070	THz 20,64 + Behälter	03.6852-0203.4	03.2123-1003.3 03.3508-8753.3 03.6850-0202.4	10175 310049 300043	THz 23,81 Behälter + WE 9"
03.6832-1301.4	03.2120-0151.3	10071	THz 20,64	03.6852-0204.4	03.2023-0112.3 03.6850-0202.4	10013 300043	THz 23,81/19,05 9"
03.6832-1505.4	03.2120-1531.3	10092	THz 20,64	03.6852-0205.4	03.2023-0166.3 03.6850-0202.4	10015 300043	THz 23,81/19,05 9"
03.6832-1704.4	03.2120-1531.3	10092	THz 20,64				
03.6832-1705.4	03.2120-1531.3	10092	THz 20,64				
03.6832-1706.4	03.2120-1531.3	10092	THz 20,64				

Bremsgeräte komplett

**Booster units complete - Servofreni completi -
Servo-freins complets - Servofreno completo**

● Die Nr. befindet sich auf dem im Fahrzeug eingebautem Aggregat.
the number is on the unit build in the car
il numero si trova sull'aggregato montato nella macchina
le numéro se trouve sur la pièce montée dans le véhicule
el n° se encuentra en el equipo montado en el vehículo



03.6852-0207.4	03.2023-0166.3 03.6850-0202.4	10015 300043	THz 23,81/19,05 9"	03.6852-2001.4	03.2123-6002.3 03.6850-2602.4	10184 300049	THz 23,81 9"
03.6852-0210.4	03.2023-0166.3 03.6850-0202.4	10015 300043	THz 23,81/19,05 9"	03.6852-2101.4	03.2120-0562.3	10078	THz 20,64
03.6852-0211.4	03.2023-0166.3 03.6850-0202.4	10015 300043	THz 23,81/19,05 9"	03.6852-2201.4	03.2123-4911.3	10182	THz 23,81
03.6852-0501.4	03.2123-2604.3 03.6850-0502.4	10178 300044	THz 23,81 + WE 9"	03.6852-2202.4	03.2123-6207.3	10185	THz 23,81
03.6852-0503.4	03.2123-2604.3 03.6850-0502.4	10178 300044	THz 23,81 + WE 9"	03.6852-2205.4	03.2120-0538.3	10077	THz 20,64
03.6852-1001.4	03.2123-5212.3 03.6850-5402.4	10183 300055	THz 23,81 9"	03.6852-2307.4	03.2120-1491.3	10089	THz 20,64 + WE
03.6852-1002.4	03.2123-5212.3 03.6850-5402.4	10183 300055	THz 23,81 9"	03.6852-2401.4	03.2120-0622.3	10079	THz 20,64
03.6852-1006.4	03.2123-0271.3 03.6850-5402.4	10164 300055	THz 23,81 + WE 9"	03.6852-2402.4	03.2120-0622.3	10079	THz 20,64
03.6852-1007.4	03.2123-0271.3 03.6850-5402.4	10164 300055	THz 23,81 + WE 9"	03.6852-2404.4	03.2120-1362.3	10087	THz 20,64
03.6852-1008.4	03.2123-0291.3 03.6850-5402.4	10165 300055	THz 23,81 9"	03.6852-2405.4	03.2120-0622.3	10079	THz 20,64
03.6852-1009.4	03.2123-0291.3 03.6850-5402.4	10165 300055	THz 23,81 9"	03.6852-3801.4	03.2120-1142.3	10085	THz 20,64
03.6852-1012.4	03.2123-0271.3 03.6850-5402.4	10164 300055	THz 23,81 + WE 9"	03.6852-3802.4	03.2123-9207.3	10199	THz 23,81
03.6852-1013.4	03.2123-0271.3 03.6850-5402.4	10164 300055	THz 23,81 + WE 9"	03.6852-4403.4	03.2122-8806.3	10157	THz 22,20
03.6852-1014.4	03.6850-5402.4	300055	9"	03.6852-4404.4	03.2122-8806.3	10157	THz 22,20
03.6852-1015.4	03.6850-5402.4	300055	9"	03.6852-4405.4	03.2122-8806.3	10157	THz 22,20
03.6852-1301.4	03.2123-6802.3	10186	THz 23,81	03.6852-4406.4	03.2122-8806.3	10157	THz 22,20
03.6852-1302.4	03.2123-6802.3	10186	THz 23,81	03.6852-4407.4	03.2122-8806.3	10157	THz 22,20
03.6852-1303.4	03.2123-6802.3	10186	THz 23,81	03.6852-4408.4	03.2122-8806.3	10157	THz 22,20
03.6852-1304.4	03.2122-6202.3	10148	THz 22,20	03.6852-4409.4	03.2122-8806.3	10157	THz 22,20
03.6852-1601.4	03.2123-6002.3 03.6850-2602.4	10184 300049	THz 23,81 9"	03.6852-4603.4	03.2123-7902.3 03.7750-5702.4	10191 300083	THz 23,81 + WE 9"
03.6852-1701.4	03.2123-9002.3	10198	THz 23,81 + WE	03.6852-4604.4	03.2123-8902.3 03.7750-5702.4	10197 300083	THz 23,81 9"
03.6852-1702.4	03.2123-9002.3	10198	THz 23,81 + WE	03.6852-4605.4	03.2023-0172.3 03.7750-5702.4	10016 300083	THz 23,81/19,05 9"
03.6852-1902.4	03.2123-4911.3	10182	THz 23,81	03.6852-4606.4	03.2023-0172.3 03.7750-5702.4	10016 300083	THz 23,81/19,05 9"
03.6852-1903.4	03.2123-6207.3	10185	THz 23,81	03.6852-4702.4	03.2123-7902.3	10191	THz 23,81 + WE
				03.6852-4703.4	03.2123-8902.3	10197	THz 23,81
				03.6852-5002.4	03.2120-1491.3	10089	THz 20,64 + WE
				03.6852-5003.4	03.2120-1531.3	10092	THz 20,64
				03.6852-5401.4	03.2123-5212.3 03.6850-5402.4	10183 300055	THz 23,81 9"

Bremsgeräte komplett

Booster units complete - Servofreni completi - Servo-freins complets - Servofreno completo

● Die Nr. befindet sich auf dem im Fahrzeug eingebautem Aggregat.
the number is on the unit build in the car
il numero si trova sull'aggregato montato nella macchina
le numéro se trouve sur la pièce montée dans le véhicule
el n° se encuentra en el equipo montado en el vehículo



03.6852-5402.4	03.2123-5212.3 03.6850-5402.4	10183 300055	THz 23,81 9"	03.6857-1203.4	03.2025-0111.3 03.6855-1202.4	10033 300056	THz 25,40/19,05 9" Tandem
03.6852-5403.4	03.2123-5212.3 03.6850-5402.4	10183 300055	THz 23,81 9"	03.6857-1204.4	03.2025-0111.3 03.6855-1202.4	10033 300056	THz 25,40/19,05 9" Tandem
03.6852-5404.4	03.2123-5212.3 03.6850-5402.4	10183 300055	THz 23,81 9"	03.6857-1205.4	03.2025-0111.3 03.6855-1202.4	10033 300056	THz 25,40/19,05 9" Tandem
03.6852-5902.4	03.2122-8012.3	10156	THz 22,20	03.6857-1401.4	03.2126-0512.3 03.6855-1402.4	10217 300057	THz 26,99 9" Tandem
03.6852-6202.4	03.2122-8012.3 03.6058-0301.3	10156 320072	THz 22,20 BR 25/5 (3)	03.6857-1402.4	03.2125-1902.3 03.6855-1402.4	10206 300057	THz 25,40 9" Tandem
03.6857-0101.4	03.2023-0166.3 03.6855-1202.4	10015 300056	THz 23,81/19,05 9" Tandem	03.6857-1403.4	03.2125-1902.3 03.6855-1402.4	10206 300057	THz 25,40 9" Tandem
03.6857-0102.4	03.2023-0112.3	10013	THz 23,81/19,05	03.6857-1404.4	03.2125-2102.3 03.6855-1402.4	10207 300057	THz 25,40 9" Tandem
03.6857-0104.4	03.2023-0112.3 03.6855-1202.4	10013 300056	THz 23,81/19,05 9" Tandem	03.6857-1405.4	03.6855-1402.4	300057	9" Tandem
03.6857-0105.4	03.2023-0166.3 03.6855-1202.4	10015 300056	THz 23,81/19,05 9" Tandem	03.6857-1406.4	03.6855-1402.4	300057	9" Tandem
03.6857-0108.4	03.2023-0166.3 03.6855-1202.4	10015 300056	THz 23,81/19,05 9" Tandem	03.6857-1407.4	03.6855-1402.4	300057	9" Tandem
03.6857-0303.4	03.2023-0166.3 03.6855-1202.4	10015 300056	THz 23,81/19,05 9" Tandem	03.6857-1408.4	03.6855-1402.4	300057	9" Tandem
03.6857-0304.4	03.2023-0166.3 03.6855-1202.4	10015 300056	THz 23,81/19,05 9" Tandem	03.6857-1409.4	03.6855-1402.4	300057	9" Tandem
03.6857-0501.4	03.2125-1712.3	10204	THz 25,40	03.6857-1410.4	03.6855-1402.4	300057	9" Tandem
03.6857-0502.4	03.2125-1712.3	10204	THz 25,40	03.6857-1411.4	03.6855-1402.4	300057	9" Tandem
03.6857-0503.4	03.2125-1712.3	10204	THz 25,40	03.6857-1413.4	03.6855-1402.4	300057	9" Tandem
03.6857-0504.4	03.2125-1712.3	10204	THz 25,40	03.6857-1416.4	03.6855-1402.4	300057	9" Tandem
03.6857-1001.4	03.2023-0166.3 03.6855-1202.4	10015 300056	THz 23,81/19,05 9" Tandem	03.6857-1417.4	03.6855-1402.4	300057	9" Tandem
03.6857-1002.4	03.2023-0166.3 03.6855-1202.4	10015 300056	THz 23,81/19,05 9" Tandem	03.6857-1420.4	03.6855-1402.4	300057	9" Tandem
03.6857-1003.4	03.2023-0166.3 03.6855-1202.4	10015 300056	THz 23,81/19,05 9" Tandem	03.6857-1421.4	03.6855-1402.4	300057	9" Tandem
03.6857-1106.4	03.2123-8512.3	10194	THz 23,81	03.6857-1422.4	03.6855-1402.4	300057	9" Tandem
03.6857-1201.4	03.2023-0166.3 03.6855-1202.4	10015 300056	THz 23,81/19,05 9" Tandem	03.6857-1423.4	03.6855-1402.4	300057	9" Tandem
03.6857-1202.4	03.2023-0166.3 03.6855-1202.4	10015 300056	THz 23,81/19,05 9" Tandem	03.6857-1424.4	03.6855-1402.4	300057	9" Tandem
				03.6857-1425.4	03.6855-1402.4	300057	9" Tandem
				03.6857-1426.4	03.6855-1402.4	300057	9" Tandem
				03.6857-1501.4	03.2125-1712.3	10204	THz 25,40
				03.6857-1502.4	03.2125-1712.3	10204	THz 25,40
				03.6857-1503.4	03.2125-1712.3	10204	THz 25,40

Bremsgeräte komplett

**Booster units complete - Servofreni completi -
Servo-freins complets - Servofreno completo**

● Die Nr. befindet sich auf dem im Fahrzeug eingebautem Aggregat.
the number is on the unit build in the car
il numero si trova sull'aggregato montato nella macchina
le numéro se trouve sur la pièce montée dans le véhicule
el n° se encuentra en el equipo montado en el vehículo



03.6857-1504.4	03.2125-1712.3	10204	THz 25,40	03.6862-0204.4	03.2023-0166.3	10015	THz 23,81/19,05
03.6857-1701.4	03.2123-6002.3 03.3558-0676.3	10184 310077	THz 23,81 Behälter + WE	03.6862-0301.4	03.2123-9002.3	10198	THz 23,81 + WE
03.6857-1801.4	03.2125-3801.3	10215	THz 25,40	03.6862-0501.4	03.2123-4911.3	10182	THz 23,81
03.6857-1901.4	03.6855-1902.4	300059	9" Tandem	03.6862-0502.4	03.2123-4911.3	10182	THz 23,81
03.6857-1902.4	03.6855-1902.4	300059	9" Tandem	03.6862-0505.4	03.2123-4911.3	10182	THz 23,81
03.6857-1905.4	03.6855-1902.4	300059	9" Tandem	03.6862-0506.4	03.2123-6207.3	10185	THz 23,81
03.6857-1906.4	03.2125-1902.3 03.6855-1902.4	10206 300059	THz 25,40 9" Tandem	03.6862-0507.4	03.2123-4911.3	10182	THz 23,81
03.6857-1907.4	03.6855-1902.4	300059	9" Tandem	03.6862-0508.4	03.2123-4911.3	10182	THz 23,81
03.6857-1910.4	03.6855-1902.4	300059	9" Tandem	03.6862-0801.4	03.2123-9002.3 03.7760-0402.4	10198 300087	THz 23,81 + WE 10"
03.6857-1911.4	03.6855-1902.4	300059	9" Tandem	03.6862-0802.4	03.2023-0183.3 03.7760-0402.4	10017 300087	THz 23,81/19,05 10"
03.6857-1912.4	03.6855-1902.4	300059	9" Tandem	03.6862-0803.4	03.7760-0402.4	300087	10"
03.6857-1913.4	03.2125-2102.3 03.6855-1902.4	10207 300059	THz 25,40 9" Tandem	03.6862-0901.4	03.2122-6911.3 03.7760-0902.4	10153 300088	THz 22,20 10"
03.6857-2101.4	03.2130-0102.3 03.6855-2202.4	10221 300061	THz 30,00 9" Tandem	03.6862-0902.4	03.2122-6911.3 03.7760-0902.4	10153 300088	THz 22,20 10"
03.6857-2103.4	03.2123-0522.3 03.6855-2202.4	10168 300061	THz 23,81 9" Tandem	03.6862-0903.4	03.2123-8311.3 03.7760-0902.4	10192 300088	THz 23,81 10"
03.6857-2201.4	03.2130-0102.3 03.6855-2202.4	10221 300061	THz 30,00 9" Tandem	03.6862-1001.4	03.2123-9207.3	10199	THz 23,81
03.6857-2202.4	03.2123-0522.3 03.6855-2202.4	10168 300061	THz 23,81 9" Tandem	03.6862-1101.4	03.2125-3801.3	10215	THz 25,40
03.6857-2203.4	03.6855-2202.4	300061	9" Tandem	03.6862-1103.4	03.2123-9207.3	10199	THz 23,81
03.6857-2204.4	03.6855-2202.4	300061	9" Tandem	03.6862-1105.4	03.2125-3801.3	10215	THz 25,40
03.6857-2205.4	03.2128-1203.3 03.6855-2202.4	10922 300061	THz 28,57 9" Tandem	03.6862-1201.4	03.2023-0262.3	10020	THz 23,81/20,64
03.6857-2301.4	03.2123-8512.3	10194	THz 23,81	03.6862-1303.4	03.2125-7002.3	10628	THz 25,40
03.6857-2401.4	03.2125-3801.3	10215	THz 25,40	03.6952-0201.4	03.2122-8012.3	10156	THz 22,20
03.6857-2402.4	03.2125-3701.3	10627	THz 25,40	03.6952-0202.4	03.2122-8012.3 03.6058-0301.3	10156 320072	THz 22,20 BR 25/5 (3)
03.6857-2403.4	03.2123-9207.3	10199	THz 23,81	03.6952-0301.4	03.2023-0172.3 03.7750-5702.4	10016 300083	THz 23,81/19,05 9"
03.6862.0904.4	03.7760-0902.4	300088	10"	03.6952-0302.4	03.2023-0172.3 03.7750-5702.4	10016 300083	THz 23,81/19,05 9"
03.6862-0201.4	03.2023-0166.3	10015	THz 23,81/19,05	03.6952-0401.4	03.2122-9612.3 03.7750-0302.4	10159 300071	THz 22,20 9"
03.6862-0202.4	03.2023-0166.3	10015	THz 23,81/19,05	03.6952-0501.4	03.2122-9612.3 03.7750-0302.4	10159 300071	THz 22,20 9"
03.6862-0203.4	03.2023-0166.3	10015	THz 23,81/19,05				

Bremsgeräte komplett

Booster units complete - Servofreni completi - Servo-freins complets - Servofreno completo

● Die Nr. befindet sich auf dem im Fahrzeug eingebautem Aggregat.
the number is on the unit build in the car
il numero si trova sull'aggregato montato nella macchina
le numéro se trouve sur la pièce montée dans le véhicule
el n° se encuentra en el equipo montado en el vehículo



03.6952-0601.4	03.2122-9612.3	10159	THz 22,20
	03.7750-0302.4	300071	9"
03.6952-0701.4	03.2122-9612.3	10159	THz 22,20
	03.7750-0302.4	300071	9"
03.7732-0201.4	03.2120-2031.3	10106	THz 20,64
03.7732-0401.4	03.2120-2031.3	10106	THz 20,64
03.7742-0801.4	03.2120-2031.3	10106	THz 20,64
03.7742-0901.4	03.2120-2031.3	10106	THz 20,64
03.7742-1402.4	03.7740-1402.4	300133	8"
03.7742-1403.4	03.7740-1402.4	300133	8"
03.7742-1404.4	03.2120-3943.3	10532	THz 20,64
	03.7740-1402.4	300133	8"
03.7742-1405.4	03.7740-1402.4	300133	8"
03.7742-2001.4	03.2120-2031.3	10106	THz 20,64
03.7742-2101.4	03.2120-2031.3	10106	THz 20,64
03.7742-2501.4	03.2119-3391.3	10058	THz 19,05
03.7742-2601.4	03.2120-1897.3	10103	THz 20,64
03.7742-3301.4	03.2120-4166.3	10452	THz 20,64
	03.7740-3302.4	300107	8"
03.7742-3501.4	03.2120-4166.3	10452	THz 20,64
03.7742-3601.4	03.2120-4166.3	10452	THz 20,64
03.7742-3701.4	03.2120-4166.3	10452	THz 20,64
03.7742-3802.4	03.2122-1184.3	10592	THz 22,20
03.7742-3806.4	03.2122-1184.3	10592	THz 22,20
03.7742-3808.4	03.2122-1184.3	10592	THz 22,20
03.7742-3901.4	03.2120-4241.3	10524	THz 20,64
03.7742-3902.4	03.2120-4246.3	10614	THz 20,64
03.7742-4001.4	03.2120-4221.3	10605	THz 20,64
03.7742-4401.4	03.2123-1484.3	10595	THz 23,81
03.7742-4402.4	03.2123-1484.3	10595	THz 23,81
03.7742-4601.4	03.2120-4321.3	10525	THz 20,64
03.7742-5401.4	03.2120-4321.3	10525	THz 20,64
03.7747-0601.4	03.2123-0921.3	10174	THz 23,81 (MKIV)

03.7747-0701.4	03.2123-0921.3	10174	THz 23,81 (MKIV)
03.7747-1301.4	03.2123-0921.3	10174	THz 23,81 (MKIV)
03.7747-1401.4	03.2123-0921.3	10174	THz 23,81 (MKIV)
03.7747-1501.4	03.2123-1622.3	10470	THz 23,81
	03.7745-3003.4	300157	8/7" Tandem
03.7747-1502.4	03.2125-7402.3	10541	THz 25,40
	03.7745-3003.4	300157	8/7" Tandem
03.7747-1503.4	03.2125-7402.3	10541	THz 25,40
	03.7745-3003.4	300157	8/7" Tandem
03.7747-1602.4	03.2125-7502.3	10616	THz 25,40
03.7747-1603.4	03.2125-7502.3	10616	THz 25,40
03.7747-1604.4	03.2125-7502.3	10616	THz 25,40
03.7747-1631.4	03.7745-1632.4	300293	8/7" Tandem
03.7747-1831.4	03.7745-1832.4	300294	8/7" Tandem
03.7747-3201.4	03.2123-2221.3	10861	THz 23,81
03.7747-3401.4	03.2123-2221.3	10861	THz 23,81
03.7747-3601.4	03.2123-2774.3	10803	THz 23,81
03.7747-3602.4	03.2123-2774.3	10803	THz 23,81
03.7747-3605.4	03.2123-2774.3	10803	THz 23,81
03.7747-3901.4	03.2125-9901.3	10634	THz 25,40
	03.7745-3902.4	300129	8/7" Tandem
03.7747-3902.4	03.2125-9901.3	10634	THz 25,40
03.7747-3903.4	03.2125-9911.3	10883	THz 25,40
	03.7745-3902.4	300129	8/7" Tandem
03.7747-4301.4	03.2123-2221.3	10861	THz 23,81
03.7747-4401.4	03.2123-2221.3	10861	THz 23,81
	03.7745-4402.4	300295	8/7" Tandem
03.7747-4402.4	03.7745-4402.4	300295	8/7" Tandem
03.7747-4600.4	03.2125-9901.3	10634	THz 25,40
03.7747-5802.4	03.2025-2301.3	10895	THz 25,40/22,20
03.7747-6301.4	03.2025-2301.3	10895	THz 25,40/22,20
	03.7745-6302.4	300261	8"
03.7747-6302.4	03.7745-6302.4	300261	8"
03.7747-6501.4	03.7745-6502.4	300296	8"

Bremsgeräte komplett

Booster units complete - Servofreni completi - Servo-freins complets - Servofreno completo

● Die Nr. befindet sich auf dem im Fahrzeug eingebautem Aggregat.
the number is on the unit build in the car
il numero si trova sull'aggregato montato nella macchina
le numéro se trouve sur la pièce montée dans le véhicule
el n° se encuentra en el equipo montado en el vehículo



03.7747-6502.4	03.7745-6502.4	300296	8"
03.7747-6503.4	03.7745-6502.4	300296	8"
03.7747-6504.4	03.7745-6502.4	300296	8"
03.7747-7101.4	03.2025-2301.3	10895	THz 25,40/22,20
03.7747-8501.4	03.4156-0073.3	10942	THz 26,99
03.7747-8901.4	03.2025-2301.3 03.7745-8902.4	10895 300297	THz 25,40/22,20 8"
03.7747-8902.4	03.2025-2301.3 03.7745-8902.4	10895 300297	THz 25,40/22,20 8"
03.7747-8903.4	03.7745-8902.4	300297	8"
03.7747-8904.4	03.7745-8902.4	300297	8"
03.7750-2333.4	03.2122-1588.3 03.7750-2332.4	10733 300113	THz 22,20 9"
03.7752-0101.4	03.2022-0602.3	10006	THz 22,20/19,05
03.7752-0102.4	03.2022-0602.3	10006	THz 22,20/19,05
03.7752-0104.4	03.2022-0602.3	10006	THz 22,20/19,05
03.7752-0132.4	03.2122-1421.3	10615	THz 22,20
03.7752-0201.4	03.2122-9612.3 03.7750-0302.4	10159 300071	THz 22,20 9"
03.7752-0204.4	03.2122-9612.3 03.7750-0302.4	10159 300071	THz 22,20 9"
03.7752-0232.4	03.2122-1461.3	10610	THz 22,20
03.7752-0241.4	03.4153-0029.4	10786	THz 23,81 + Behälter
03.7752-0302.4	03.2122-9612.3 03.7750-0302.4	10159 300071	THz 22,20 9"
03.7752-0341.4	03.2120-4611.3 03.2125-0493.3 03.2126-3144.3	10937 10940 10941	THz 20,64 THz 25,40 THz 26,99
03.7752-0342.4	03.2122-2031.3	10938	THz 22,20
03.7752-0401.4	03.2023-0562.3 03.7750-0302.4	10025 300071	THz 23,81/20,64 9"
03.7752-0402.4	03.2023-0542.3 03.7750-0302.4	10024 300071	THz 23,81/20,64 9"
03.7752-0404.4	03.7750-5702.4	300083	9"
03.7752-0405.4	03.2023-0542.3 03.7750-5702.4	10024 300083	THz 23,81/20,64 9"

03.7752-0442.4	03.2122-2031.3	10938	THz 22,20
03.7752-0443.4	03.2120-4611.3 03.2125-0493.3 03.2126-3144.3	10937 10940 10941	THz 20,64 THz 25,40 THz 26,99
03.7752-0501.4	03.2122-9612.3 03.7750-0302.4	10159 300071	THz 22,20 9"
03.7752-0532.4	03.2120-4321.3 03.7750-0532.4	10525 300110	THz 20,64 9"
03.7752-0541.4	03.2120-4611.3 03.2125-0493.3 03.2126-3144.3	10937 10940 10941	THz 20,64 THz 25,40 THz 26,99
03.7752-0707.4	03.2122-0264.3	10129	THz 22,20
03.7752-0708.4	03.2122-0264.3	10129	THz 22,20
03.7752-0709.4	03.2122-0264.3	10129	THz 22,20
03.7752-0710.4	03.2122-0282.3	10130	THz 22,20
03.7752-0713.4	03.2122-0264.3	10129	THz 22,20
03.7752-0714.4	03.2122-0264.3	10129	THz 22,20
03.7752-0715.4	03.2122-0264.3	10129	THz 22,20
03.7752-0716.4	03.2122-0264.3	10129	THz 22,20
03.7752-0717.4	03.2122-0264.3	10129	THz 22,20
03.7752-0718.4	03.2122-0264.3	10129	THz 22,20
03.7752-0722.4	03.2122-0264.3	10129	THz 22,20
03.7752-0723.4	03.2123-1121.3	10176	THz 23,81
03.7752-0808.4	03.2122-0264.3	10129	THz 22,20
03.7752-0809.4	03.2122-0264.3	10129	THz 22,20
03.7752-0810.4	03.2122-0282.3	10130	THz 22,20
03.7752-0813.4	03.2122-0264.3	10129	THz 22,20
03.7752-0814.4	03.2122-0264.3	10129	THz 22,20
03.7752-0815.4	03.2122-0264.3	10129	THz 22,20
03.7752-0816.4	03.2122-0264.3	10129	THz 22,20
03.7752-0819.4	03.2122-0264.3	10129	THz 22,20
03.7752-0820.4	03.2123-1121.3	10176	THz 23,81
03.7752-0831.4	03.2122-1691.3	10918	THz 22,20

Bremsgeräte komplett

Booster units complete - Servofreni completi -
Servo-freins complets - Servofreno completo

● Die Nr. befindet sich auf dem im Fahrzeug eingebautem Aggregat.
the number is on the unit build in the car
il numero si trova sull'aggregato montato nella macchina
le numéro se trouve sur la pièce montée dans le véhicule
el n° se encuentra en el equipo montado en el vehículo



03.7752-0901.4	03.2122-1042.3 03.7750-4302.4	10137 300076	THz 22,20 9"
03.7752-0902.4	03.2120-3943.3 03.7750-4302.4	10532 300076	THz 20,64 9"
03.7752-1001.4	03.7750-7402.4	300084	9"
03.7752-1005.4	03.2122-0646.3 03.7750-7402.4	10133 300084	THz 22,20 9"
03.7752-1006.4	03.2122-0646.3 03.7750-7402.4	10133 300084	THz 22,20 9"
03.7752-1031.4	03.2123-1484.3	10595	THz 23,81
03.7752-1201.4	03.2122-1042.3 03.7750-4902.4	10137 300079	THz 22,20 9"
03.7752-1202.4	03.2120-3943.3 03.7750-4902.4	10532 300079	THz 20,64 9"
03.7752-1204.4	03.2120-3943.3 03.7750-4902.4	10532 300079	THz 20,64 9"
03.7752-1331.4	03.2120-4381.3 03.7750-1332.4	10526 300155	THz 20,64 9"
03.7752-1332.4	03.2120-4461.3 03.7750-1332.4	10571 300155	THz 20,64 9"
03.7752-1831.4	03.2122-1356.3 03.7750-1832.4	10529 300111	THz 22,20 9"
03.7752-1832.4	03.2122-1351.3 03.7750-1832.4	10528 300111	THz 22,20 9"
03.7752-1833.4	03.2122-1351.3 03.7750-1832.4	10528 300111	THz 22,20 9"
03.7752-1834.4	03.2122-1356.3 03.7750-1832.4	10529 300111	THz 22,20 9"
03.7752-2041.4	03.2120-4611.3 03.2125-0493.3 03.2126-3144.3	10937 10940 10941	THz 20,64 THz 25,40 THz 26,99
03.7752-2042.4	03.2122-2031.3	10938	THz 22,20
03.7752-2142.4	03.2122-2031.3	10938	THz 22,20
03.7752-2231.4	03.4122-0031.3 03.7750-2232.4	10611 300112	THz 22,20 9"
03.7752-2232.4	03.4122-0041.3 03.7750-2232.4	10612 300112	THz 22,20 9"
03.7752-2331.4	03.2122-1564.3 03.7750-2332.4	10594 300113	THz 22,20 9"
03.7752-2332.4	03.7750-2332.4	300113	9"

03.7752-2333.4	03.2122-1588.3 03.7750-2332.4	10733 300113	THz 22,20 9"
03.7752-2334.4	03.2123-2243.3 03.7750-2332.4	10748 300113	THz 23,81 9"
03.7752-2335.4	03.7750-2332.4	300113	9"
03.7752-2336.4	03.7750-2332.4	300113	9"
03.7752-2402.4	03.2122-0621.3	10131	THz 22,20
03.7752-2431.4	03.2122-1564.3	10594	THz 22,20
03.7752-2433.4	03.2122-1588.3	10733	THz 22,20
03.7752-2434.4	03.2123-2243.3	10748	THz 23,81
03.7752-2601.4	03.0101-0025.2 03.2120-3943.3 03.7750-5502.4	320014 10532 300081	BRES 3/35 THz 20,64 9"
03.7752-2603.4	03.2120-3943.3 03.7750-5502.4	10532 300081	THz 20,64 9"
03.7752-2604.4	03.0101-0025.2 03.2120-3943.3 03.7750-5502.4	320014 10532 300081	BRES 3/35 THz 20,64 9"
03.7752-2607.4	03.2120-3943.3 03.7750-5502.4	10532 300081	THz 20,64 9"
03.7752-2608.4	03.2120-3943.3 03.7750-5502.4	10532 300081	THz 20,64 9"
03.7752-2631.4	03.2122-1691.3	10918	THz 22,20
03.7752-2632.4	03.2122-1691.3	10918	THz 22,20
03.7752-2701.4	03.2120-3943.3	10532	THz 20,64
03.7752-2731.4	03.2122-1691.3	10918	THz 22,20
03.7752-2732.4	03.2122-1691.3	10918	THz 22,20
03.7752-2801.4	03.2122-0264.3	10129	THz 22,20
03.7752-2931.4	03.2123-1626.3 03.7750-2932.4	10727 300175	THz 23,81 9"
03.7752-3031.4	03.2123-1626.3	10727	THz 23,81
03.7752-3101.4	03.2120-3943.3	10532	THz 20,64
03.7752-3103.4	03.2120-3943.3	10532	THz 20,64
03.7752-3131.4	03.2122-1184.3	10592	THz 22,20
03.7752-3231.4	03.4153-0015.4 03.7750-8732.4	10784 300199	THz 23,81 + Behälter 9"

Bremsgeräte komplett

**Booster units complete - Servofreni completi -
Servo-freins complets - Servofreno completo**

● Die Nr. befindet sich auf dem im Fahrzeug eingebautem Aggregat.
the number is on the unit build in the car
il numero si trova sull'aggregato montato nella macchina
le numéro se trouve sur la pièce montée dans le véhicule
el n° se encuentra en el equipo montado en el vehículo



03.7752-3232.4	03.4153-0029.4 03.7750-8732.4	10786 300199	THz 23,81 + Behälter 9"	03.7752-4701.4	03.2120-2031.3 03.7750-4702.4	10106 300153	THz 20,64 9"
03.7752-3233.4	03.7750-8732.4	300199	9"	03.7752-4702.4	03.7750-4702.4	300153	9"
03.7752-3234.4	03.7750-8732.4	300199	9"	03.7752-4703.4	03.2120-4441.3 03.7750-4702.4	10510 300153	THz 20,64 9"
03.7752-3401.4	03.2122-0264.3	10129	THz 22,20	03.7752-4901.4	03.2122-1042.3 03.7750-4902.4	10137 300079	THz 22,20 9"
03.7752-3402.4	03.2122-0282.3	10130	THz 22,20	03.7752-5431.4	03.7750-5432.4	300248	9"
03.7752-3403.4	03.2123-1121.3	10176	THz 23,81	03.7752-5432.4	03.7750-5432.4	300248	9"
03.7752-3405.4	03.2122-0282.3	10130	THz 22,20	03.7752-5433.4	03.7750-5432.4	300248	9"
03.7752-3501.4	03.2122-0264.3	10129	THz 22,20	03.7752-5509.4	03.7750-5502.4	300081	9"
03.7752-3502.4	03.2122-0282.3	10130	THz 22,20	03.7752-5510.4	03.7750-5502.4	300081	9"
03.7752-3504.4	03.2123-1121.3	10176	THz 23,81	03.7752-5511.4	03.7750-5502.4	300081	9"
03.7752-3510.4	03.2122-0282.3	10130	THz 22,20	03.7752-5512.4	03.7750-5502.4	300081	9"
03.7752-3531.4	03.2123-2781.3 03.7750-3532.4	10631 300149	THz 23,81 9"	03.7752-5513.4	03.7750-5502.4	300081	9"
03.7752-3532.4	03.2123-2781.3 03.7750-3532.4	10631 300149	THz 23,81 9"	03.7752-5514.4	03.7750-5502.4	300081	9"
03.7752-3533.4	03.7750-3532.4	300149	9"	03.7752-5631.4	03.2123-2243.3	10748	THz 23,81
03.7752-3534.4	03.2123-2781.3 03.7750-3532.4	10631 300149	THz 23,81 9"	03.7752-5731.4	03.4153-0015.4 03.7750-8732.4	10784 300199	THz 23,81 + Behälter 9"
03.7752-3731.4	03.2122-1184.3	10592	THz 22,20	03.7752-5732.4	03.4153-0029.4 03.7750-8732.4	10786 300199	THz 23,81 + Behälter 9"
03.7752-3831.4	03.2123-1484.3	10595	THz 23,81	03.7752-5733.4	03.7750-8732.4	300199	9"
03.7752-4231.4	03.2123-2781.3	10631	THz 23,81	03.7752-5734.4	03.7750-8732.4	300199	9"
03.7752-4232.4	03.2123-2781.3	10631	THz 23,81	03.7752-5739.4	03.4153-0015.4 03.7750-8732.4	10784 300199	THz 23,81 + Behälter 9"
03.7752-4233.4	03.2123-2781.3	10631	THz 23,81	03.7752-5740.4	03.4153-0029.4 03.7750-8732.4	10786 300199	THz 23,81 + Behälter 9"
03.7752-4302.4	03.2122-1042.3 03.7750-4302.4	10137 300076	THz 22,20 9"	03.7752-5741.4	03.7750-8732.4	300199	9"
03.7752-4401.4	03.2123-1121.3	10176	THz 23,81	03.7752-5742.4	03.7750-8732.4	300199	9"
03.7752-4402.4	03.2123-1121.3	10176	THz 23,81	03.7752-6001.4	03.7750-6002.4	300134	9"
03.7752-4431.4	03.2122-1926.3	10916	THz 22,20	03.7752-6002.4	03.7750-6002.4	300134	9"
03.7752-4501.4	03.2123-1121.3	10176	THz 23,81	03.7752-6003.4	03.2122-1184.3 03.7750-6002.4	10592 300134	THz 22,20 9"
03.7752-4503.4	03.2123-1121.3	10176	THz 23,81	03.7752-6102.4	03.2122-1042.3	10137	THz 22,20
03.7752-4531.4	03.2123-2781.3	10631	THz 23,81	03.7752-6104.4	03.2122-1042.3	10137	THz 22,20
03.7752-4532.4	03.2123-2781.3	10631	THz 23,81				

Bremsgeräte komplett

Booster units complete - Servofreni completi - Servo-freins complets - Servofreno completo

● Die Nr. befindet sich auf dem im Fahrzeug eingebautem Aggregat.
the number is on the unit build in the car
il numero si trova sull'aggregato montato nella macchina
le numéro se trouve sur la pièce montée dans le véhicule
el n° se encuentra en el equipo montado en el vehículo



03.7752-6131.4	03.2120-4321.3	10525	THz 20,64
03.7752-6132.4	03.2120-4321.3	10525	THz 20,64
03.7752-6231.4	03.2122-1356.3	10529	THz 22,20
	03.7750-6232.4	300215	9"
03.7752-6232.4	03.2122-1356.3	10529	THz 22,20
	03.7750-6232.4	300215	9"
03.7752-6301.4	03.7750-6302.4	300161	9"
03.7752-6302.4	03.7750-6302.4	300161	9"
03.7752-6303.4	03.7750-6302.4	300161	9"
03.7752-6304.4	03.7750-6302.4	300161	9"
03.7752-6305.4	03.7750-6302.4	300161	9"
03.7752-6306.4	03.7750-6302.4	300161	9"
03.7752-6331.4	03.4122-0031.3	10611	THz 22,20
	03.7750-6332.4	300226	9"
03.7752-6403.4	03.2122-1184.3	10592	THz 22,20
03.7752-6404.4	03.2123-1484.3	10595	THz 23,81
03.7752-6802.4	03.2123-1484.3	10595	THz 23,81
03.7752-6902.4	03.2123-1484.3	10595	THz 23,81
03.7752-6903.4	03.2123-1484.3	10595	THz 23,81
03.7752-7131.4	03.7750-7132.4	300255	9"
03.7752-7132.4	03.7750-7132.4	300255	9"
03.7752-7332.4	03.2120-4641.3	10932	THz 20,64
	03.7750-7332.4	300298	9"
03.7752-7401.4	03.2122-1042.3	10137	THz 22,20
	03.7750-7402.4	300084	9"
03.7752-7431.4	03.4153-0029.4	10786	THz 23,81 + Behälter
03.7752-7435.4	03.4153-0029.4	10786	THz 23,81 + Behälter
03.7752-8105.4	03.2122-1331.3	10607	THz 22,20
03.7752-8107.4	03.2122-1281.3	10606	THz 22,20
03.7752-8108.4	03.2122-1331.3	10607	THz 22,20
03.7752-8201.4	03.2122-1281.3	10606	THz 22,20
03.7752-8432.4	03.2120-4611.3	10937	THz 20,64
	03.2125-0493.3	10940	THz 25,40
	03.2126-3144.3	10941	THz 26,99

03.7752-8437.4	03.2120-4611.3	10937	THz 20,64
	03.2125-0493.3	10940	THz 25,40
	03.2126-3144.3	10941	THz 26,99
03.7752-8533.4	03.7750-8532.4	300264	9"
03.7752-8534.4	03.2120-4611.3	10937	THz 20,64
	03.2125-0493.3	10940	THz 25,40
	03.2126-3144.3	10941	THz 26,99
	03.7750-8532.4	300264	9"
03.7752-8535.4	03.2122-2031.3	10938	THz 22,20
	03.7750-8532.4	300264	9"
03.7752-8536.4	03.2120-4611.3	10937	THz 20,64
	03.2125-0493.3	10940	THz 25,40
	03.2126-3144.3	10941	THz 26,99
	03.7750-8532.4	300264	9"
03.7752-8537.4	03.2122-2031.3	10938	THz 22,20
	03.7750-8532.4	300264	9"
03.7752-8601.4	03.2122-1281.3	10606	THz 22,20
03.7752-8631.4	03.2120-4611.3	10937	THz 20,64
	03.2125-0493.3	10940	THz 25,40
	03.2126-3144.3	10941	THz 26,99
03.7752-8632.4	03.2125-0493.3	10940	THz 25,40
	03.2126-3144.3	10941	THz 26,99
03.7752-8633.4	03.2122-2031.3	10938	THz 22,20
03.7752-8731.4	03.4153-0015.4	10784	THz 23,81 + Behälter
	03.7750-8732.4	300199	9"
03.7752-8732.4	03.7750-8732.4	300199	9"
03.7752-8733.4	03.4153-0029.4	10786	THz 23,81 + Behälter
	03.7750-8732.4	300199	9"
03.7752-8734.4	03.7750-8732.4	300199	9"
03.7752-8735.4	03.4153-0015.4	10784	THz 23,81 + Behälter
	03.7750-8732.4	300199	9"
03.7752-8831.4	03.7750-8832.4	300299	9"
03.7752-9001.4	03.2123-1581.3	10487	THz 23,81 (MKIV)
03.7752-9101.4	03.2123-1581.3	10487	THz 23,81 (MKIV)
03.7752-9231.4	03.2120-4611.3	10937	THz 20,64
	03.2125-0493.3	10940	THz 25,40
	03.2126-3144.3	10941	THz 26,99
03.7752-9233.4	03.2122-2031.3	10938	THz 22,20
03.7752-9301.4	03.2120-4321.3	10525	THz 20,64
	03.7750-9302.4	300116	9"

Bremsgeräte komplett

**Booster units complete - Servofreni completi -
Servo-freins complets - Servofreno completo**

● Die Nr. befindet sich auf dem im Fahrzeug eingebautem Aggregat.
the number is on the unit build in the car
il numero si trova sull'aggregato montato nella macchina
le numéro se trouve sur la pièce montée dans le véhicule
el n° se encuentra en el equipo montado en el vehículo



03.7752-9302.4	03.2122-1356.3 03.7750-9302.4	10529 300116	THz 22,20 9"
03.7752-9303.4	03.2120-4321.3 03.7750-9302.4	10525 300116	THz 20,64 9"
03.7752-9304.4	03.2122-1356.3 03.7750-9302.4	10529 300116	THz 22,20 9"
03.7752-9305.4	03.2120-4321.3 03.7750-9302.4	10525 300116	THz 20,64 9"
03.7752-9306.4	03.2122-1356.3 03.7750-9302.4	10529 300116	THz 22,20 9"
03.7752-9307.4	03.2122-1351.3 03.7750-9302.4	10528 300116	THz 22,20 9"
03.7752-9308.4	03.2122-1351.3 03.7750-9302.4	10528 300116	THz 22,20 9"
03.7752-9309.4	03.2122-1356.3 03.7750-9302.4	10529 300116	THz 22,20 9"
03.7752-9310.4	03.2122-1351.3 03.7750-9302.4	10528 300116	THz 22,20 9"
03.7752-9401.4	03.2122-1351.3 03.7750-9402.4	10528 300117	THz 22,20 9"
03.7752-9402.4	03.2122-1351.3 03.7750-9402.4	10528 300117	THz 22,20 9"
03.7752-9403.4	03.2122-1351.3 03.7750-9402.4	10528 300117	THz 22,20 9"
03.7752-9532.4	03.2122-2031.3	10938	THz 22,20
03.7752-9702.4	03.2123-2221.3	10861	THz 23,81
03.7752-9703.4	03.2123-2221.3	10861	THz 23,81
03.7752-9704.4	03.2123-2221.3	10861	THz 23,81
03.7752-9705.4	03.2123-2221.3	10861	THz 23,81
03.7752-9706.4	03.2123-2221.3	10861	THz 23,81
03.7752-9802.4	03.2123-2221.3 03.7750-2532.4	10861 300225	THz 23,81 9"
03.7752-9803.4	03.2123-2221.3 03.7750-2532.4	10861 300225	THz 23,81 9"
03.7752-9804.4	03.2123-2221.3 03.7750-2532.4	10861 300225	THz 23,81 9"
03.7752-9805.4	03.2123-2221.3 03.7750-2532.4	10861 300225	THz 23,81 9"

03.7752-9806.4	03.2123-2221.3 03.7750-2532.4	10861 300225	THz 23,81 9"
03.7757-0101.4	03.2023-0230.3	10019	THz 23,81/19,05
03.7757-0102.4	03.2023-0825.3	10028	THz 23,81/19,05
03.7757-0131.4	03.7755-0132.4	300265	9/8" Tandem
03.7757-0201.4	03.2025-0211.3	10034	THz 25,40/19,05
03.7757-0203.4	03.7750-0302.4	300071	9"
03.7757-0204.4	03.7750-0302.4	300071	9"
03.7757-0231.4	03.4156-0073.3	10942	THz 26,99
03.7757-0314.4	03.2023-0642.3	10026	THz 23,81/20,64
03.7757-0319.4	03.2023-0642.3	10026	THz 23,81/20,64
03.7757-0321.4	03.2023-0642.3	10026	THz 23,81/20,64
03.7757-0324.4	03.2023-0642.3	10026	THz 23,81/20,64
03.7757-0631.4	03.2125-0651.3	10935	THz 25,40
03.7757-0632.4	03.2125-0651.3	10935	THz 25,40
03.7757-0633.4	03.2125-0651.3	10935	THz 25,40
03.7757-0801.4	03.2123-1526.3 03.7755-4202.4	10477 300164	THz 23,81 9/8" Tandem
03.7757-0802.4	03.2123-1526.3 03.7755-4202.4	10477 300164	THz 23,81 9/8" Tandem
03.7757-0803.4	03.2123-1548.3 03.7755-4202.4	10478 300164	THz 23,81 9/8" Tandem
03.7757-0804.4	03.2123-1548.3 03.7755-4202.4	10478 300164	THz 23,81 9/8" Tandem
03.7757-0805.4	03.2125-8111.3 03.7755-4202.4	10479 300164	THz 25,40 9/8" Tandem
03.7757-0806.4	03.2125-8111.3 03.7755-4202.4	10479 300164	THz 25,40 9/8" Tandem
03.7757-0901.4	03.2123-1486.3	10488	THz 23,81
03.7757-0902.4	03.2123-1741.3	10537	THz 23,81
03.7757-1001.4	03.2123-1486.3	10488	THz 23,81
03.7757-1002.4	03.2123-1741.3	10537	THz 23,81
03.7757-1031.4	03.2125-0651.3	10935	THz 25,40
03.7757-1032.4	03.2125-0651.3	10935	THz 25,40



Bremsgeräte komplett

**Booster units complete - Servofreni completi -
Servo-freins complets - Servofreno completo**

● Die Nr. befindet sich auf dem im Fahrzeug eingebautem Aggregat.
the number is on the unit build in the car
il numero si trova sull'aggregato montato nella macchina
le numéro se trouve sur la pièce montée dans le véhicule
el n° se encuentra en el equipo montado en el vehículo



03.7757-1033.4	03.2125-0651.3	10935	THz 25,40
03.7757-1034.4	03.2125-0651.3	10935	THz 25,40
03.7757-1201.4	03.7755-3402.4	300189	9/8" Tandem
03.7757-1202.4	03.7755-3402.4	300189	9/8" Tandem
03.7757-1203.4	03.7755-3402.4	300189	9/8" Tandem
03.7757-1204.4	03.7755-3402.4	300189	9/8" Tandem
03.7757-1205.4	03.7755-3402.4	300189	9/8" Tandem
03.7757-1206.4	03.7755-3402.4	300189	9/8" Tandem
03.7757-1207.4	03.2125-7637.3 03.7755-3402.4	10707 300189	THz 25,40 9/8" Tandem
03.7757-1208.4	03.2125-7743.3 03.7755-3402.4	10921 300189	THz 25,40 9/8" Tandem
03.7757-1209.4	03.2125-7638.3 03.7755-3402.4	10738 300189	THz 25,40 9/8" Tandem
03.7757-1210.4	03.2125-7743.3 03.7755-3402.4	10921 300189	THz 25,40 9/8" Tandem
03.7757-1231.4	03.7755-1232.4	300260	9/8" Tandem
03.7757-1431.4	03.7755-1432.4	300300	9/8" Tandem
03.7757-1501.4	03.2125-8404.3 03.7755-1902.4	10583 300138	THz 25,40 9/8" Tandem
03.7757-1601.4	03.2125-8404.3	10583	THz 25,40
03.7757-1902.4	03.2125-0343.3 03.7755-1902.4	10896 300138	THz 25,40 9/8" Tandem
03.7757-1903.4	03.2125-0343.3 03.7755-1902.4	10896 300138	THz 25,40 9/8" Tandem
03.7757-2002.4	03.2125-0343.3	10896	THz 25,40
03.7757-2004.4	03.2125-0343.3	10896	THz 25,40
03.7757-2201.4	03.2125-9704.3 03.7755-4302.4	10603 300165	THz 25,40 9/8" Tandem
03.7757-2202.4	03.2125-9704.3 03.7755-4302.4	10603 300165	THz 25,40 9/8" Tandem
03.7757-2203.4	03.2125-9704.3 03.7755-4302.4	10603 300165	THz 25,40 9/8" Tandem
03.7757-2501.4	03.2123-1486.3	10488	THz 23,81
03.7757-2503.4	03.2123-2621.3	10701	THz 23,81
03.7757-2601.4	03.2123-1486.3	10488	THz 23,81

03.7757-2603.4	03.2123-2621.3	10701	THz 23,81
03.7757-2801.4	03.2125-0343.3 03.7755-6302.4	10896 300221	THz 25,40 9/8" Tandem
03.7757-2802.4	03.2125-0343.3 03.7755-6302.4	10896 300221	THz 25,40 9/8" Tandem
03.7757-2803.4	03.2125-0343.3 03.7755-6302.4	10896 300221	THz 25,40 9/8" Tandem
03.7757-2804.4	03.2125-0343.3 03.7755-6302.4	10896 300221	THz 25,40 9/8" Tandem
03.7757-2805.4	03.2125-0343.3 03.7755-6302.4	10896 300221	THz 25,40 9/8" Tandem
03.7757-2806.4	03.2125-0343.3 03.7755-6302.4	10896 300221	THz 25,40 9/8" Tandem
03.7757-2807.4	03.2125-0343.3 03.7755-6302.4	10896 300221	THz 25,40 9/8" Tandem
03.7757-2808.4	03.2125-0343.3 03.7755-6302.4	10896 300221	THz 25,40 9/8" Tandem
03.7757-2811.4	03.2125-0343.3 03.7755-6302.4	10896 300221	THz 25,40 9/8" Tandem
03.7757-2812.4	03.2125-0343.3 03.7755-6302.4	10896 300221	THz 25,40 9/8" Tandem
03.7757-2931.4	03.2125-0651.3	10935	THz 25,40
03.7757-3201.4	03.2123-1526.3 03.7755-4202.4	10477 300164	THz 23,81 9/8" Tandem
03.7757-3202.4	03.2123-1526.3 03.7755-4202.4	10477 300164	THz 23,81 9/8" Tandem
03.7757-3203.4	03.2123-1548.3 03.7755-4202.4	10478 300164	THz 23,81 9/8" Tandem
03.7757-3204.4	03.2123-1548.3 03.7755-4202.4	10478 300164	THz 23,81 9/8" Tandem
03.7757-3205.4	03.2125-8111.3 03.7755-4202.4	10479 300164	THz 25,40 9/8" Tandem
03.7757-3206.4	03.2125-8111.3 03.7755-4202.4	10479 300164	THz 25,40 9/8" Tandem
03.7757-3301.4	03.2125-9704.3 03.7755-4302.4	10603 300165	THz 25,40 9/8" Tandem
03.7757-3302.4	03.2125-9704.3 03.7755-4302.4	10603 300165	THz 25,40 9/8" Tandem
03.7757-3303.4	03.2125-9704.3 03.7755-4302.4	10603 300165	THz 25,40 9/8" Tandem

Bremsgeräte komplett

Booster units complete - Servofreni completi - Servo-freins complets - Servofreno completo

● Die Nr. befindet sich auf dem im Fahrzeug eingebautem Aggregat.
the number is on the unit build in the car
il numero si trova sull'aggregato montato nella macchina
le numéro se trouve sur la pièce montée dans le véhicule
el n° se encuentra en el equipo montado en el vehículo



03.7757-3401.4	03.2125-7743.3	10921	THz 25,40
	03.7755-3402.4	300189	9/8" Tandem
03.7757-3402.4	03.2125-7638.3	10738	THz 25,40
	03.7755-3402.4	300189	9/8" Tandem
03.7757-3501.4	03.2123-2621.3	10701	THz 23,81
03.7757-3531.4	03.2125-0651.3	10935	THz 25,40
03.7757-3601.4	03.2123-2621.3	10701	THz 23,81
03.7757-3701.4	03.2125-7743.3	10921	THz 25,40
	03.7755-4702.4	300224	9/8" Tandem
03.7757-3702.4	03.2125-7638.3	10738	THz 25,40
	03.7755-4702.4	300224	9/8" Tandem
03.7757-3801.4	03.2125-7638.3	10738	THz 25,40
03.7757-4501.4	03.2125-7743.3	10921	THz 25,40
03.7757-4601.4	03.2125-7638.3	10738	THz 25,40
03.7757-4701.4	03.2125-7743.3	10921	THz 25,40
	03.7755-4702.4	300224	9/8" Tandem
03.7757-4702.4	03.2125-7637.3	10707	THz 25,40
	03.2125-7638.3	10738	THz 25,40
	03.7755-4702.4	300224	9/8" Tandem
03.7757-4703.4	03.2125-7743.3	10921	THz 25,40
	03.7755-4702.4	300224	9/8" Tandem
03.7757-4704.4	03.2125-7638.3	10738	THz 25,40
	03.7755-4702.4	300224	9/8" Tandem
03.7757-4705.4	03.2125-7743.3	10921	THz 25,40
	03.7755-4702.4	300224	9/8" Tandem
03.7757-4706.4	03.2125-7638.3	10738	THz 25,40
	03.7755-4702.4	300224	9/8" Tandem
03.7757-4707.4	03.2125-7743.3	10921	THz 25,40
	03.7755-4702.4	300224	9/8" Tandem
03.7757-4708.4	03.2125-7638.3	10738	THz 25,40
	03.7755-4702.4	300224	9/8" Tandem
03.7757-4807.4	03.2125-0161.3	10920	THz 25,40
03.7757-4808.4	03.2125-0531.3	10945	THz 25,40
03.7757-4813.4	03.2125-0161.3	10920	THz 25,40
03.7757-5001.4	03.2125-7743.3	10921	THz 25,40
03.7757-5002.4	03.2125-7638.3	10738	THz 25,40
03.7757-5301.4	03.7755-1432.4	300300	9/8" Tandem

03.7757-5501.4	03.7755-9703.4	300239	9/8" Tandem
03.7757-5502.4	03.7755-9703.4	300239	9/8" Tandem
03.7757-6101.4	03.7755-1232.4	300260	9/8" Tandem
03.7757-6102.4	03.7755-1232.4	300260	9/8" Tandem
03.7757-6201.4	03.7755-1432.4	300300	9/8" Tandem
03.7757-6202.4	03.7755-1432.4	300300	9/8" Tandem
03.7757-6301.4	03.7755-6302.4	300221	9/8" Tandem
03.7757-6302.4	03.7755-6302.4	300221	9/8" Tandem
03.7757-6303.4	03.2125-0343.3	10896	THz 25,40
	03.7755-6302.4	300221	9/8" Tandem
03.7757-6401.4	03.7755-1432.4	300300	9/8" Tandem
03.7757-6402.4	03.7755-1432.4	300300	9/8" Tandem
03.7757-6404.4	03.7755-1432.4	300300	9/8" Tandem
03.7757-6405.4	03.7755-1432.4	300300	9/8" Tandem
03.7757-7301.4	03.2025-2301.3	10895	THz 25,40/22,20
03.7757-7501.4	03.7755-7703.4	300247	9/8" Tandem
03.7757-7601.4	03.7755-0132.4	300265	9/8" Tandem
03.7757-7701.4	03.2125-0651.3	10935	THz 25,40
	03.7755-7703.4	300247	9/8" Tandem
03.7757-7702.4	03.2125-0651.3	10935	THz 25,40
	03.7755-7703.4	300247	9/8" Tandem
03.7757-8201.4	03.2126-3146.3	10936	THz 26,99
	03.7755-8202.4	300301	9/8" Tandem
03.7757-8801.4	03.4156-0073.3	10942	THz 26,99
03.7757-9001.4	03.2126-3146.3	10936	THz 26,99
03.7757-9002.4	03.2126-3146.3	10936	THz 26,99
03.7757-9301.4	03.7755-1232.4	300260	9/8" Tandem
03.7757-9401.4	03.7755-1432.4	300300	9/8" Tandem
03.7757-9402.4	03.7755-1432.4	300300	9/8" Tandem
03.7757-9501.4	03.7755-1432.4	300300	9/8" Tandem
03.7757-9601.4	03.7755-1432.4	300300	9/8" Tandem
03.7757-9701.4	03.7755-9703.4	300239	9/8" Tandem

Bremsgeräte komplett

Booster units complete - Servofreni completi - Servo-freins complets - Servofreno completo

● Die Nr. befindet sich auf dem im Fahrzeug eingebautem Aggregat.
the number is on the unit build in the car
il numero si trova sull'aggregato montato nella macchina
le numéro se trouve sur la pièce montée dans le véhicule
el n° se encuentra en el equipo montado en el vehículo



03.7762-0101.4	03.2123-8311.3 03.7760-0902.4	10192 300088	THz 23,81 10"	03.7762-0301.4	03.2023-0825.3 03.7760-2702.4	10028 300090	THz 23,81/19,05 10"
03.7762-0102.4	03.2122-6911.3 03.7760-0902.4	10153 300088	THz 22,20 10"	03.7762-0302.4	03.2023-0825.3 03.7760-2702.4	10028 300090	THz 23,81/19,05 10"
03.7762-0103.4	03.2122-6911.3 03.7760-0902.4	10153 300088	THz 22,20 10"	03.7762-0312.4	03.2023-0825.3 03.7760-2702.4	10028 300090	THz 23,81/19,05 10"
03.7762-0104.4	03.7760-0902.4	300088	10"	03.7762-0313.4	03.2023-0825.3 03.7760-2702.4	10028 300090	THz 23,81/19,05 10"
03.7762-0108.4	03.2120-2082.3 03.7760-0902.4	10107 300088	THz 20,64 10"	03.7762-0401.4	03.2023-0262.3 03.7760-0402.4	10020 300087	THz 23,81/20,64 10"
03.7762-0110.4	03.2120-1802.3 03.7760-0902.4	10099 300088	THz 20,64 10"	03.7762-0402.4	03.7760-0402.4	300087	10"
03.7762-0112.4	03.2120-1802.3 03.7760-0902.4	10099 300088	THz 20,64 10"	03.7762-0501.4	03.2120-1802.3 03.7760-0902.4	10099 300088	THz 20,64 10"
03.7762-0114.4	03.2020-0402.3 03.7760-0902.4	10001 300088	THz 20,64/19,05 10"	03.7762-0502.4	03.2120-2082.3 03.7760-0902.4	10107 300088	THz 20,64 10"
03.7762-0115.4	03.2120-2082.3 03.7760-0902.4	10107 300088	THz 20,64 10"	03.7762-0503.4	03.7760-0902.4	300088	10"
03.7762-0116.4	03.2123-8311.3 03.7760-0902.4	10192 300088	THz 23,81 10"	03.7762-0504.4	03.2120-1802.3 03.7760-0902.4	10099 300088	THz 20,64 10"
03.7762-0117.4	03.7760-0902.4	300088	10"	03.7762-0505.4	03.2120-2082.3 03.7760-0902.4	10107 300088	THz 20,64 10"
03.7762-0118.4	03.2123-8311.3 03.7760-0902.4	10192 300088	THz 23,81 10"	03.7762-0506.4	03.7760-0902.4	300088	10"
03.7762-0119.4	03.2120-2082.3 03.7760-0902.4	10107 300088	THz 20,64 10"	03.7762-0631.4	03.2125-0483.3 03.7760-2232.4	10783 300266	THz 25,40 10"
03.7762-0120.4	03.2120-2082.3 03.7760-0902.4	10107 300088	THz 20,64 10"	03.7762-0632.4	03.2125-0483.3 03.7760-2232.4	10783 300266	THz 25,40 10"
03.7762-0121.4	03.2120-1802.3 03.7760-0902.4	10099 300088	THz 20,64 10"	03.7762-0701.4	03.2022-1201.3 03.7760-0902.4	10009 300088	THz 22,20/17,46 10"
03.7762-0122.4	03.2120-1802.3 03.7760-0902.4	10099 300088	THz 20,64 10"	03.7762-0702.4	03.2022-1201.3 03.7760-0902.4	10009 300088	THz 22,20/17,46 10"
03.7762-0123.4	03.2020-0402.3 03.7760-0902.4	10001 300088	THz 20,64/19,05 10"	03.7762-0703.4	03.2022-1201.3 03.7760-0902.4	10009 300088	THz 22,20/17,46 10"
03.7762-0124.4	03.7760-0902.4	300088	10"	03.7762-0704.4	03.2022-1201.3 03.7760-0902.4	10009 300088	THz 22,20/17,46 10"
03.7762-0201.4	03.2020-0402.3 03.7760-0902.4	10001 300088	THz 20,64/19,05 10"	03.7762-0705.4	03.2022-1201.3 03.7760-0902.4	10009 300088	THz 22,20/17,46 10"
03.7762-0202.4	03.2120-1802.3 03.7760-0902.4	10099 300088	THz 20,64 10"	03.7762-0731.4	03.2123-2821.3	10944	THz 23,81
03.7762-0204.4	03.2120-2082.3 03.7760-0902.4	10107 300088	THz 20,64 10"	03.7762-0801.4	03.2022-1201.3 03.7760-0902.4	10009 300088	THz 22,20/17,46 10"
				03.7762-0802.4	03.2022-1201.3 03.7760-0902.4	10009 300088	THz 22,20/17,46 10"

Bremsgeräte komplett

**Booster units complete - Servofreni completi -
Servo-freins complets - Servofreno completo**

● Die Nr. befindet sich auf dem im Fahrzeug eingebautem Aggregat.
the number is on the unit build in the car
il numero si trova sull'aggregato montato nella macchina
le numéro se trouve sur la pièce montée dans le véhicule
el n° se encuentra en el equipo montado en el vehículo



03.7762-0901.4	03.2022-1201.3 03.7760-0902.4	10009 300088	THz 22,20/17,46 10"
03.7762-0902.4	03.2022-1201.3 03.7760-0902.4	10009 300088	THz 22,20/17,46 10"
03.7762-1001.4	03.2125-3011.3	10211	THz 25,40
03.7762-1002.4	03.2125-3011.3	10211	THz 25,40
03.7762-1032.4	03.2123-3041.3 03.7760-2332.4	10887 300267	THz 23,81 10"
03.7762-1203.4	03.2125-3011.3	10211	THz 25,40
03.7762-1204.4	03.2125-3011.3	10211	THz 25,40
03.7762-1801.4	03.2125-3011.3	10211	THz 25,40
03.7762-1802.4	03.2125-3011.3	10211	THz 25,40
03.7762-1901.4	03.2125-3011.3	10211	THz 25,40
03.7762-1902.4	03.2125-3011.3	10211	THz 25,40
03.7762-2001.4	03.2125-3011.3	10211	THz 25,40
03.7762-2002.4	03.2125-3011.3	10211	THz 25,40
03.7762-2031.4	03.2125-0483.3	10783	THz 25,40
03.7762-2032.4	03.2125-0483.3	10783	THz 25,40
03.7762-2033.4	03.2125-0661.3	10917	THz 25,40
03.7762-2034.4	03.2125-0661.3	10917	THz 25,40
03.7762-2231.4	03.2125-0661.3 03.7760-2232.4	10917 300266	THz 25,40 10"
03.7762-2232.4	03.2125-0661.3 03.7760-2232.4	10917 300266	THz 25,40 10"
03.7762-2233.4	03.2125-0661.3 03.7760-2232.4	10917 300266	THz 25,40 10"
03.7762-2234.4	03.7760-2232.4	300266	10"
03.7762-2331.4	03.2123-3041.3 03.7760-2332.4	10887 300267	THz 23,81 10"
03.7762-2332.4	03.7760-2332.4	300267	10"
03.7762-2333.4	03.2123-3041.3 03.7760-2332.4	10887 300267	THz 23,81 10"
03.7762-2334.4	03.7760-2332.4	300267	10"
03.7762-2402.4	03.2023-0987.3	10473	THz 23,81/20,64

03.7762-2701.4	03.2023-0825.3 03.7760-2702.4	10028 300090	THz 23,81/19,05 10"
03.7762-3102.4	03.2023-0987.3 03.7760-3102.4	10473 300139	THz 23,81/20,64 10"
03.7762-3103.4	03.2023-0987.3 03.7760-3102.4	10473 300139	THz 23,81/20,64 10"
03.7762-3109.4	03.2023-0987.3 03.7760-3102.4	10473 300139	THz 23,81/20,64 10"
03.7762-3110.4	03.2023-1904.3 03.7760-3102.4	10724 300139	THz 23,81/20,64 10"
03.7762-3111.4	03.2023-1904.3 03.7760-3102.4	10724 300139	THz 23,81/20,64 10"
03.7762-3120.4	03.2023-1949.3 03.7760-3102.4	10725 300139	THz 23,81/20,64 10"
03.7762-3121.4	03.2023-1949.3 03.7760-3102.4	10725 300139	THz 23,81/20,64 10"
03.7762-3606.4	03.2023-1084.3 03.7760-3602.4	10591 300176	THz 23,81/20,64 10"
03.7762-3607.4	03.2023-1044.3 03.7760-3602.4	10590 300176	THz 23,81/20,64 10"
03.7762-3706.4	03.2023-1084.3	10591	THz 23,81/20,64
03.7762-3707.4	03.2023-1044.3	10590	THz 23,81/20,64
03.7762-4101.4	03.2023-1066.3 03.7760-4102.4	10032 300091	THz 23,81/19,05 10"
03.7762-4102.4	03.2023-1066.3 03.7760-4102.4	10032 300091	THz 23,81/19,05 10"
03.7762-4201.4	03.7760-4202.4	300145	10"
03.7762-4202.4	03.7760-4202.4	300145	10"
03.7762-4203.4	03.2123-1486.3 03.7760-4202.4	10488 300145	THz 23,81 10"
03.7762-4204.4	03.2123-1546.3 03.7760-4202.4	10536 300145	THz 23,81 10"
03.7762-4301.4	03.2123-1486.3	10488	THz 23,81
03.7762-4302.4	03.2123-1546.3	10536	THz 23,81
03.7762-4603.4	03.2123-2164.3	10599	THz 23,81
03.7762-4803.4	03.2123-2164.3	10599	THz 23,81
03.7762-4901.4	03.7760-4902.4	300178	10"

Bremsgeräte komplett

Booster units complete - Servofreni completi - Servo-freins complets - Servofreno completo

● Die Nr. befindet sich auf dem im Fahrzeug eingebautem Aggregat.
the number is on the unit build in the car
il numero si trova sull'aggregato montato nella macchina
le numéro se trouve sur la pièce montée dans le véhicule
el n° se encuentra en el equipo montado en el vehículo



03.7762-4903.4	03.2123-2164.3	10599	THz 23,81	03.7762-8105.4	03.2123-3103.3	10781	THz 23,81
	03.7760-4902.4	300178	10"		03.7760-8103.4	300240	10"
03.7762-5003.4	03.2123-2164.3	10599	THz 23,81	03.7762-9101.4	03.2123-3103.3	10781	THz 23,81
03.7762-5101.4	03.2123-2146.3	10572	THz 23,81	03.7762-9601.4	03.2125-0483.3	10783	THz 25,40
	03.7760-5102.4	300140	10"		03.7760-2232.4	300266	10"
03.7762-5102.4	03.2123-1551.3	10512	THz 23,81	03.7762-9602.4	03.2125-0483.3	10783	THz 25,40
	03.7760-5102.4	300140	10"		03.7760-2232.4	300266	10"
03.7762-5103.4	03.7760-5102.4	300140	10"	03.7762-9701.4	03.4152-0020.3	10929	THz 22,20 + Behälter
03.7762-5104.4	03.7760-5102.4	300140	10"	03.7762-9801.4	03.2123-3041.3	10887	THz 23,81
03.7762-5202.4	03.2120-4441.3	10510	THz 20,64		03.7760-2332.4	300267	10"
03.7762-5301.4	03.2122-1351.3	10528	THz 22,20	03.7767-0101.4	03.2026-0462.3	10728	THz 26,99/25,40
	03.7760-5302.4	300179	10"	03.7767-0102.4	03.2026-0462.3	10728	THz 26,99/25,40
03.7762-5401.4	03.2123-2146.3	10572	THz 23,81	03.7767-0103.4	03.2026-0512.3	10038	THz 26,99/25,40
	03.7760-5102.4	300140	10"	03.7767-0104.4	03.2026-0512.3	10038	THz 26,99/25,40
03.7762-5501.4	03.2122-1521.3	10494	THz 22,20	03.7767-0105.4	03.2026-0462.3	10728	THz 26,99/25,40
	03.7760-5502.4	300151	10"	03.7767-0106.4	03.2026-0562.3	10729	THz 26,99/25,40
03.7762-5503.4	03.2122-1541.3	10511	THz 22,20	03.7767-0107.4	03.2026-0462.3	10728	THz 26,99/25,40
	03.7760-5502.4	300151	10"	03.7767-0108.4	03.2026-0562.3	10729	THz 26,99/25,40
03.7762-5602.4	03.2123-1551.3	10512	THz 23,81	03.7767-0502.4	03.2126-3014.3	10811	THz 26,99
	03.7760-5602.4	300121	10"		03.7765-1002.4	300246	10/9" Tandem
03.7762-5603.4	03.2122-1541.3	10511	THz 22,20	03.7767-1001.4	03.2126-3014.3	10811	THz 26,99
	03.7760-5602.4	300121	10"		03.7765-1002.4	300246	10/9" Tandem
03.7762-6201.4	03.2123-2164.3	10599	THz 23,81	03.7767-1302.4	03.2126-3144.3	10941	THz 26,99
03.7762-6301.4	03.2123-2164.3	10599	THz 23,81	03.7767-1303.4	03.2126-3144.3	10941	THz 26,99
03.7762-6901.4	03.2123-2821.3	10944	THz 23,81	03.7767-1401.4	03.2126-3144.3	10941	THz 26,99
03.7762-7110.4	03.2123-3041.3	10887	THz 23,81	03.7847-0101.4	03.2025-1904.3	10797	THz 25,40/22,20
	03.7760-2332.4	300267	10"		03.7845-0103.4	300268	8"
03.7762-7111.4	03.2123-3041.3	10887	THz 23,81	03.7847-0102.4	03.7845-0103.4	300268	8"
	03.7760-2332.4	300267	10"	03.7847-0103.4	03.2025-1904.3	10797	THz 25,40/22,20
03.7762-7114.4	03.2123-3041.3	10887	THz 23,81		03.7845-0103.4	300268	8"
	03.7760-2332.4	300267	10"	03.7847-0104.4	03.7845-0103.4	300268	8"
03.7762-7631.4	03.2123-2821.3	10944	THz 23,81	03.7847-0401.4	03.2023-2407.3	10796	THz 23,81/22,20
03.7762-8101.4	03.2123-3103.3	10781	THz 23,81	03.7847-0501.4	03.2025-1904.3	10797	THz 25,40/22,20
	03.7760-8103.4	300240	10"	03.7847-0601.4	03.2025-1904.3	10797	THz 25,40/22,20
03.7762-8102.4	03.2123-3103.3	10781	THz 23,81	03.7849-0101.4	03.2123-2064.3	10598	THz 23,81
	03.7760-8103.4	300240	10"				
03.7762-8104.4	03.2123-3103.3	10781	THz 23,81				
	03.7760-8103.4	300240	10"				

Bremsgeräte komplett

Booster units complete - Servofreni completi - Servo-freins complets - Servofreno completo

● Die Nr. befindet sich auf dem im Fahrzeug eingebautem Aggregat.
the number is on the unit build in the car
il numero si trova sull'aggregato montato nella macchina
le numéro se trouve sur la pièce montée dans le véhicule
el n° se encuentra en el equipo montado en el vehículo



03.7849-0201.4	03.2023-1741.3	10703	THz 23,81/20,64
	03.7848-2002.4	300166	7/8" Tandem
03.7849-0202.4	03.2025-1741.3	10705	THz 25,40/20,64
	03.7848-2002.4	300166	7/8" Tandem
03.7849-0203.4	03.7848-2002.4	300166	7/8" Tandem
03.7849-0204.4	03.7848-2002.4	300166	7/8" Tandem
03.7849-0901.4	03.2025-1741.3	10705	THz 25,40/20,64
03.7849-0902.4	03.2025-1741.3	10705	THz 25,40/20,64
03.7849-1201.4	03.2123-2064.3	10598	THz 23,81
03.7849-2001.4	03.7848-2002.4	300166	7/8" Tandem
03.7849-2002.4	03.7848-2002.4	300166	7/8" Tandem
03.7849-3001.4	03.7848-9402.4	300227	7/8" Tandem
03.7849-3301.4	03.4125-0032.3	10955	THz 25,40
03.7849-4001.4	03.2023-2407.3	10796	THz 23,81/22,20
	03.7848-4003.4	300235	8"
03.7849-4002.4	03.7848-4003.4	300235	8"
03.7849-4005.4	03.2023-2407.3	10796	THz 23,81/22,20
	03.7848-4003.4	300235	8"
03.7849-4006.4	03.7848-4003.4	300235	8"
03.7849-5001.4	03.2025-1904.3	10797	THz 25,40/22,20
	03.7848-5003.4	300236	8"
03.7849-5002.4	03.7848-5003.4	300236	8"
03.7849-5005.4	03.2025-1904.3	10797	THz 25,40/22,20
	03.7848-5003.4	300236	8"
03.7849-5006.4	03.7848-5003.4	300236	8"
03.7849-6201.4	03.7848-9402.4	300227	7/8" Tandem
03.7849-9401.4	03.7848-9402.4	300227	7/8" Tandem
03.7852-0102.4	03.2122-1883.3	10735	THz 22,20
	03.7850-0102.4	300180	9"
03.7852-0103.4	03.2122-1888.3	10736	THz 22,20
	03.7850-0102.4	300180	9"
03.7854-0101.4	03.7853-0102.4	300252	9"
03.7854-0102.4	03.7853-0102.4	300252	9"
03.7854-0201.4	03.7853-0202.4	300181	9"
03.7854-0202.4	03.7853-0202.4	300181	9"

03.7854-0701.4	03.7853-0702.4	300195	9"
03.7854-0702.4	03.7853-0702.4	300195	9"
03.7854-0901.4	03.7853-0902.4	300150	9"
03.7854-0902.4	03.7853-0902.4	300150	9"
03.7854-0903.4	03.7853-0902.4	300150	9"
03.7854-0904.4	03.7853-0902.4	300150	9"
03.7854-0905.4	03.7853-0902.4	300150	9"
03.7854-0906.4	03.7853-0902.4	300150	9"
03.7854-0907.4	03.7853-0902.4	300150	9"
03.7854-0908.4	03.7853-0902.4	300150	9"
03.7854-1501.4	03.2120-4461.3	10571	THz 20,64
	03.7853-1502.4	300200	9"
03.7854-1502.4	03.7853-1502.4	300200	9"
03.7854-1601.4	03.2122-1351.3	10528	THz 22,20
	03.7853-1602.4	300167	9"
03.7854-1602.4	03.2122-1942.3	10700	THz 22,20
03.7854-1603.4	03.2122-1351.3	10528	THz 22,20
03.7854-1604.4	03.2122-1942.3	10700	THz 22,20
03.7854-1701.4	03.4122-0041.3	10612	THz 22,20
03.7854-1703.4	03.4122-0041.3	10612	THz 22,20
03.7854-2101.4	03.7853-2102.4	300201	9"
03.7854-2102.4	03.7853-2102.4	300201	9"
03.7854-2103.4	03.7853-2102.4	300201	9"
03.7854-2104.4	03.7853-2102.4	300201	9"
03.7854-2105.4	03.7853-2102.4	300201	9"
03.7854-2106.4	03.7853-2102.4	300201	9"
03.7854-2107.4	03.7853-2102.4	300201	9"
03.7854-2108.4	03.7853-2102.4	300201	9"
03.7854-2109.4	03.7853-2102.4	300201	9"
03.7854-2110.4	03.7853-2102.4	300201	9"
03.7854-2111.4	03.7853-2102.4	300201	9"
03.7854-2112.4	03.7853-2102.4	300201	9"

Bremsgeräte komplett

Booster units complete - Servofreni completi - Servo-freins complets - Servofreno completo

● Die Nr. befindet sich auf dem im Fahrzeug eingebautem Aggregat.
the number is on the unit build in the car
il numero si trova sull'aggregato montato nella macchina
le numéro se trouve sur la pièce montée dans le véhicule
el n° se encuentra en el equipo montado en el vehículo



03.7854-2113.4	03.7853-2102.4	300201	9"
03.7854-2114.4	03.7853-2102.4	300201	9"
03.7854-2115.4	03.7853-2102.4	300201	9"
03.7854-2116.4	03.7853-2102.4	300201	9"
03.7854-2601.4	03.7853-2602.4	300196	9"
03.7854-2602.4	03.7853-2602.4	300196	9"
03.7854-2701.4	03.7853-2702.4	300269	9"
03.7854-2702.4	03.7853-2702.4	300269	9"
03.7854-3901.4	03.7853-3902.4	300270	9"
03.7854-4101.4	03.2120-4611.3	10937	THz 20,64
	03.2125-0493.3	10940	THz 25,40
	03.2126-3144.3	10941	THz 26,99
	03.7853-4102.4	300271	9"
03.7854-4103.4	03.2122-2031.3	10938	THz 22,20
	03.7853-4102.4	300271	9"
03.7854-4105.4	03.2120-4611.3	10937	THz 20,64
	03.2125-0493.3	10940	THz 25,40
	03.2126-3144.3	10941	THz 26,99
	03.7853-4102.4	300271	9"
03.7854-4106.4	03.2120-4611.3	10937	THz 20,64
	03.2125-0493.3	10940	THz 25,40
	03.2126-3144.3	10941	THz 26,99
	03.7853-4102.4	300271	9"
03.7854-4108.4	03.7853-4102.4	300271	9"
03.7854-4501.4	03.2120-4611.3	10937	THz 20,64
	03.2125-0493.3	10940	THz 25,40
	03.2126-3144.3	10941	THz 26,99
03.7854-4502.4	03.2122-2031.3	10938	THz 22,20
03.7854-4601.4	03.2120-4611.3	10937	THz 20,64
	03.2125-0493.3	10940	THz 25,40
	03.2126-3144.3	10941	THz 26,99
	03.7853-4602.4	300302	9"
03.7854-4602.4	03.2122-2031.3	10938	THz 22,20
	03.7853-4602.4	300302	9"
03.7854-4603.4	03.7853-4602.4	300302	9"
03.7854-4701.4	03.2120-4611.3	10937	THz 20,64
	03.2125-0493.3	10940	THz 25,40
	03.2126-3144.3	10941	THz 26,99
03.7854-4702.4	03.2122-2031.3	10938	THz 22,20

03.7854-5401.4	03.2120-4611.3	10937	THz 20,64
	03.2125-0493.3	10940	THz 25,40
	03.2126-3144.3	10941	THz 26,99
03.7854-5402.4	03.2122-2031.3	10938	THz 22,20
03.7854-5404.4	03.2122-2031.3	10938	THz 22,20
03.7854-5406.4	03.2120-4611.3	10937	THz 20,64
	03.2125-0493.3	10940	THz 25,40
	03.2126-3144.3	10941	THz 26,99
03.7854-5501.4	03.2120-4611.3	10937	THz 20,64
	03.2125-0493.3	10940	THz 25,40
	03.2126-3144.3	10941	THz 26,99
03.7854-5502.4	03.2122-2031.3	10938	THz 22,20
03.7854-6001.4	03.2122-2031.3	10938	THz 22,20
03.7857-0301.4	03.2125-0421.3	10934	THz 25,40
03.7859-0101.4	03.7858-0102.4	300262	9/8" Tandem
03.7859-0103.4	03.7858-0102.4	300262	9/8" Tandem
03.7859-0731.4	03.7858-0732.4	300272	9/8" Tandem
03.7859-0732.4	03.2125-0421.3	10934	THz 25,40
	03.7858-0732.4	300272	9/8" Tandem
03.7859-0932.4	03.2125-0421.3	10934	THz 25,40
03.7859-0933.4	03.2125-0421.3	10934	THz 25,40
03.7859-1231.4	03.2125-0493.3	10940	THz 25,40
03.7859-1931.4	03.7858-1932.4	300263	9/8" Tandem
03.7859-2801.4	03.7858-2802.4	300303	9/8" Tandem
03.7859-2802.4	03.7858-2802.4	300303	9/8" Tandem
03.7859-3301.4	03.2125-9604.3	10581	THz 25,40
	03.7858-3302.4	300122	9/8" Tandem
03.7859-3302.4	03.2125-9604.3	10581	THz 25,40
	03.7858-3302.4	300122	9/8" Tandem
03.7859-3631.4	03.7858-3632.4	300234	9/8" Tandem
03.7859-4001.4	03.7858-3532.4	300233	9/8" Tandem
03.7859-4002.4	03.7858-3532.4	300233	9/8" Tandem
03.7859-4431.4	03.7858-4432.4	300304	9/8" Tandem
03.7859-4502.4	03.7858-4502.4	300202	9/8" Tandem
03.7859-4631.4	03.2125-0493.3	10940	THz 25,40
	03.7858-4632.4	300273	9/8" Tandem

Bremsgeräte komplett

**Booster units complete - Servofreni completi -
Servo-freins complets - Servofreno completo**

● Die Nr. befindet sich auf dem im Fahrzeug eingebautem Aggregat.
the number is on the unit build in the car
il numero si trova sull'aggregato montato nella macchina
le numéro se trouve sur la pièce montée dans le véhicule
el n° se encuentra en el equipo montado en el vehículo



03.7859-4632.4	03.7858-4632.4	300273	9/8" Tandem	03.7862-4301.4	03.2122-2163.3	10800	THz 22,20
					03.7860-4302.4	300231	10"
03.7859-4831.4	03.7858-4832.4	300274	9/8" Tandem	03.7862-4701.4	03.2123-3421.3	10933	THz 23,81
03.7859-5031.4	03.7858-5032.4	300275	9/8" Tandem	03.7862-4801.4	03.2123-3421.3	10933	THz 23,81
03.7859-5131.4	03.7858-5132.4	300276	9/8" Tandem	03.7862-5301.4	03.2123-3421.3	10933	THz 23,81
03.7859-5232.4	03.2125-0421.3	10934	THz 25,40	03.7862-5701.4	03.7860-5702.4	300279	10"
03.7859-5233.4	03.2125-0421.3	10934	THz 25,40	03.7862-5801.4	03.7860-3732.4	300306	10"
03.7859-5234.4	03.2125-0421.3	10934	THz 25,40	03.7862-7801.4	03.7860-7802.4	300280	10"
03.7859-5331.4	03.2125-0421.3	10934	THz 25,40	03.7862-8601.4	03.2123-3421.3	10933	THz 23,81
03.7859-6001.4	03.7858-3532.4	300233	9/8" Tandem	03.7864-0331.4	03.7863-0332.4	300203	10"
03.7859-6002.4	03.7858-3532.4	300233	9/8" Tandem	03.7864-0332.4	03.7863-0332.4	300203	10"
03.7859-6101.4	03.7858-3632.4	300234	9/8" Tandem	03.7864-0401.4	03.2123-2024.3	10597	THz 23,81
03.7859-6102.4	03.7858-3632.4	300234	9/8" Tandem		03.7863-0402.4	300124	10"
03.7859-6103.4	03.7858-3632.4	300234	9/8" Tandem	03.7864-0402.4	03.2123-2024.3	10597	THz 23,81
03.7859-7601.4	03.7858-7602.4	300277	9/8" Tandem		03.7863-0402.4	300124	10"
03.7862-0601.4	03.7860-0602.4	300141	10"	03.7864-0730.4	03.7863-3932.4	300288	10"
03.7862-0602.4	03.7860-0602.4	300141	10"	03.7864-0731.4	03.7863-3932.4	300288	10"
03.7862-0603.4	03.7860-0602.4	300141	10"	03.7864-0831.4	03.2123-3593.3	10919	THz 23,81
03.7862-0604.4	03.7860-0602.4	300141	10"		03.7863-4832.4	300289	10"
03.7862-0605.4	03.7860-0602.4	300141	10"	03.7864-0901.4	03.7863-0903.4	300244	10"
03.7862-0606.4	03.7860-0602.4	300141	10"	03.7864-0902.4	03.7863-0903.4	300244	10"
03.7862-1201.4	03.7860-1202.4	300187	10"	03.7864-1101.4	03.2023-2004.3	10788	THz 23,81/19,05
03.7862-1403.4	03.7860-1402.4	300228	10"		03.7863-0903.4	300244	10"
03.7862-1405.4	03.7860-1402.4	300228	10"	03.7864-1102.4	03.7863-0903.4	300244	10"
03.7862-1406.4	03.7860-1402.4	300228	10"	03.7864-2001.4	03.2123-2146.3	10572	THz 23,81
03.7862-2801.4	03.2123-3421.3	10933	THz 23,81		03.7863-2002.4	300126	10"
03.7862-3301.4	03.2123-3421.3	10933	THz 23,81	03.7864-2003.4	03.2123-2621.3	10701	THz 23,81
03.7862-3701.4	03.7860-3702.4	300305	9"		03.7863-2002.4	300126	10"
03.7862-3901.4	03.7860-3902.4	300278	10"	03.7864-2101.4	03.2122-1521.3	10494	THz 22,20
03.7862-3902.4	03.7860-3902.4	300278	10"		03.7863-2002.4	300126	10"
03.7862-3903.4	03.7860-3902.4	300278	10"	03.7864-2201.4	03.2123-2581.3	10613	THz 23,81
					03.7863-2202.4	300127	10"
				03.7864-2301.4	03.2123-2581.3	10613	THz 23,81
				03.7864-2801.4	03.2123-2561.3	10629	THz 23,81
					03.7863-2802.4	300188	10"
				03.7864-3001.4	03.7863-3002.4	300223	10"

Bremsgeräte komplett

Booster units complete - Servofreni completi -
Servo-freins complets - Servofreno completo

● Die Nr. befindet sich auf dem im Fahrzeug eingebautem Aggregat.
the number is on the unit build in the car
il numero si trova sull'aggregato montato nella macchina
le numéro se trouve sur la pièce montée dans le véhicule
el n° se encuentra en el equipo montado en el vehículo



03.7864-3233.4	03.7863-3232.4	300307	10"
03.7864-3234.4	03.7863-3232.4	300307	10"
03.7864-3235.4	03.7863-3232.4	300307	10"
03.7864-3236.4	03.7863-3232.4	300307	10"
03.7864-3237.4	03.7863-3232.4	300307	10"
03.7864-3331.4	03.7863-3332.4	300308	10"
03.7864-3332.4	03.7863-3332.4	300308	10"
03.7864-3503.4	03.2123-2715.3 03.7863-3502.4	10802 300128	THz 23,81 10"
03.7864-3504.4	03.2123-2715.3 03.7863-3502.4	10802 300128	THz 23,81 10"
03.7864-3601.4	03.2122-2129.3 03.7873-4302.4	10799 300312	THz 22,20 11"
03.7864-3602.4	03.2122-2129.3 03.7873-4302.4	10799 300312	THz 22,20 11"
03.7864-4401.4	03.2122-1351.3	10528	THz 22,20
03.7864-4402.4	03.2122-1942.3	10700	THz 22,20
03.7864-4501.4	03.7863-4502.4	300230	10"
03.7864-4502.4	03.2123-3493.3 03.7863-4502.4	10792 300230	THz 23,81 10"
03.7864-5001.4	03.2122-1351.3	10528	THz 22,20
03.7864-5002.4	03.2122-1942.3	10700	THz 22,20
03.7864-5003.4	03.2122-1351.3	10528	THz 22,20
03.7864-5004.4	03.2122-1942.3	10700	THz 22,20
03.7864-5301.4	03.2122-2129.3	10799	THz 22,20
03.7864-5302.4	03.2122-2129.3	10799	THz 22,20
03.7864-6001.4	03.7863-6002.4	300249	10"
03.7864-6002.4	03.7863-6002.4	300249	10"
03.7864-6302.4	03.2122-2129.3	10799	THz 22,20
03.7864-7801.4	03.7863-7803.4	300237	10"
03.7864-7802.4	03.7863-7803.4	300237	10"
03.7864-7803.4	03.4155-0153.3 03.7863-7803.4	10927 300237	THz 25,40 10"

03.7864-7804.4	03.4155-0156.3 03.7863-7803.4	10862 300237	THz 25,40 10"
03.7864-8501.4	03.7863-3932.4	300288	10"
03.7864-8502.4	03.7863-3932.4	300288	10"
03.7864-9101.4	03.4152-0020.3	10929	THz 22,20 + Behälter
03.7864-9201.4	03.4152-0020.3	10929	THz 22,20 + Behälter
03.7864-9501.4	03.7863-9502.4	300204	10"
03.7864-9502.4	03.7863-9502.4	300204	10"
03.7864-9801.4	03.7863-9802.4	300281	10"
03.7869-4101.4	03.7868-4102.4	300250	10/8" Tandem
03.7869-4701.4	03.7868-4702.4	300253	10/8" Tandem
03.7869-4702.4	03.7868-4702.4	300253	10/8" Tandem
03.7869-4703.4	03.7868-4702.4	300253	10/8" Tandem
03.7869-5201.4	03.7868-5202.4	300309	10"
03.7869-5301.4	03.7868-5302.4	300251	10/8" Tandem
03.7872-0607.4	03.7870-0602.4	300310	11"
03.7872-0608.4	03.7870-0602.4	300310	11"
03.7872-1101.4	03.2123-3421.3	10933	THz 23,81
03.7872-1201.4	03.2123-3421.3	10933	THz 23,81
03.7872-1601.4	03.2123-3421.3 03.7870-1602.4	10933 300311	THz 23,81 11"
03.7874-1201.4	03.7873-1202.4	300197	11"
03.7874-1202.4	03.7873-1202.4	300197	11"
03.7874-1205.4	03.4153-0063.3 03.7873-1202.4	10773 300197	THz 23,81 11"
03.7874-1305.4	03.4153-0063.3	10773	THz 23,81
03.7874-1801.4	03.2122-2129.3	10799	THz 22,20
03.7874-2601.4	03.4153-0063.3	10773	THz 23,81
03.7874-2701.4	03.4153-0063.3	10773	THz 23,81
03.7874-3001.4	03.2122-2129.3	10799	THz 22,20
03.7874-3701.4	03.7873-3702.4	300283	11"
03.7874-3702.4	03.7873-3702.4	300283	11"

Bremsgeräte komplett

Booster units complete - Servofreni completi -
Servo-freins complets - Servofreno completo

● Die Nr. befindet sich auf dem im Fahrzeug eingebautem Aggregat.
the number is on the unit build in the car
il numero si trova sull'aggregato montato nella macchina
le numéro se trouve sur la pièce montée dans le véhicule
el n° se encuentra en el equipo montado en el vehículo



03.7874-3901.4	03.7873-3902.4	300254	11"
03.7874-3902.4	03.7873-3902.4	300254	11"
03.7874-4304.4	03.7873-4302.4	300312	11"
03.7874-4305.4	03.7873-4302.4	300312	11"
03.7874-4501.4	03.7873-4502.4	300284	11"
03.7874-4502.4	03.7873-4502.4	300284	11"
03.7874-4503.4	03.7873-4502.4	300284	11"
03.7874-4504.4	03.7873-4502.4	300284	11"
03.7874-4505.4	03.7873-4502.4	300284	11"
03.7874-4506.4	03.7873-4502.4	300284	11"
10.6350-2002.4	10.6123-0522.3	10633	THz 23,81
10.6352-0601.4	10.6350-0603.4	300159	9"
10.6352-0602.4	10.6350-0603.4	300159	9"
10.6352-0603.4	10.6350-0603.4	300159	9"
10.6352-0604.4	10.6350-0603.4	300159	9"
10.6352-2901.4	10.6350-3902.4	300213	9"
10.6352-2902.4	10.6350-3902.4	300213	9"
10.6352-4001.4	03.2122-1421.3	10615	THz 22,20
	10.6350-4002.4	300285	9"
10.6353-2901.4	10.6350-3902.4	300213	9"
10.6353-2902.4	10.6350-3902.4	300213	9"
10.6353-4001.4	03.2122-1421.3	10615	THz 22,20
	10.6350-4002.4	300285	9"
10.6362-0403.4	10.6360-1903.4	300093	10" (MKIV)
10.6362-0501.4	10.6360-1003.4	300156	10"
10.6362-0502.4	10.6360-1003.4	300156	10"
10.6362-0503.4	10.6360-1003.4	300156	10"
10.6362-0504.4	10.6360-1003.4	300156	10"
10.6362-1001.4	10.6360-1003.4	300156	10"
10.6362-1002.4	10.6360-1003.4	300156	10"
10.6362-1003.4	10.6360-1003.4	300156	10"
10.6362-1004.4	10.6360-1003.4	300156	10"

10.6362-1301.4	10.6360-1302.4	300286	10"
10.6362-1302.4	10.6360-1302.4	300286	10"
10.6362-1905.4	10.6360-1903.4	300093	10" (MKIV)
10.6362-2001.4	10.6360-2002.4	300143	10"
10.6362-2002.4	10.6360-2002.4	300143	10"



A large rectangular area containing 30 horizontal lines, intended for writing or drawing.



A large rectangular area containing 30 horizontal lines, intended for writing or drawing.



ⓁⓂⓃ **Reparatursätze**





ⓁⓂⓃ **Repair kits**

ⓁⓂⓃ **Nécessaires de réparation**

ⓁⓂⓃ **Juegos de reparación**





Reparatursätze

Repair kits - Corredi riparazione - Nécessaires de réparation - Juegos de reparación

					
03.2122-2202.3010140	03.0370-3922.2 053922 THz Reparatursatz		03.3508-3600.3310030	03.3556-1164.2 390437 Verschraubung	
03.2122-4902.3010144	03.0370-3922.2 053922 THz Reparatursatz		03.3508-5201.3310037	03.3556-1164.2 390437 Verschraubung	
03.2415-0512.3030001	03.0350-1508.2 071508 Gz Reparatursatz		03.3508-5851.3310039	03.3556-1164.2 390437 Verschraubung	
03.2415-0514.3030002	03.0350-1508.2 071508 Gz Reparatursatz		03.3508-5951.3310041	03.3556-1164.2 390437 Verschraubung	
03.2415-0515.3030003	03.0350-1508.2 071508 Gz Reparatursatz		03.3508-8302.3310046	03.3556-1164.2 390437 Verschraubung	
03.2419-3307.3030014	03.0350-1906.2 071906 Gz Reparatursatz		03.3508-8326.3310047	03.3556-1164.2 390437 Verschraubung	
03.2419-7800.3030016	03.0350-1919.2 071919 Gz Reparatursatz		03.3508-8753.3310049	03.3556-1164.2 390437 Verschraubung	
03.2419-9000.3030025	03.0350-1919.2 071919 Gz Reparatursatz		03.3508-8801.3310050	03.3556-1164.2 390437 Verschraubung	
03.2515-1101.3040001	03.0450-1502.2 081502 Nz Reparatursatz		03.3508-8802.3310051	03.3556-1094.2 390427 Verschraubung + WE	
03.2520-1201.3040011	03.0450-2006.2 082006 Nz Reparatursatz		03.3508-8901.3310054	03.3556-1164.2 390437 Verschraubung	
03.2523-0811.3040019	03.0450-2311.2 082311 Nz Reparatursatz		03.3508-8902.3310055	03.3556-1094.2 390427 Verschraubung + WE	
03.2525-1802.3040025	03.0450-2509.2 082509 Nz Reparatursatz		03.3508-9503.3310056	03.3556-1141.2 390434 Verschraubung	
03.2525-2602.3040029	03.0450-2510.2 082510 Nz Reparatursatz		03.3509-0100.3310057	03.3556-1164.2 390437 Verschraubung	
03.2525-2711.3040030	03.0450-2510.2 082510 Nz Reparatursatz		03.3509-0218.3310062	03.3506-0016.2 390255 Ausgleichskappe	
03.2528-1301.3040032	03.0450-2805.2 082805 Nz Reparatursatz		03.3509-0600.3310065	03.3556-1164.2 390437 Verschraubung	
03.2538-0102.3040033	03.0450-3801.2 083801 Nz Reparatursatz		03.3509-1000.3310066	03.3556-1164.2 390437 Verschraubung	
03.2538-0104.3040035	03.0450-3801.2 083801 Nz Reparatursatz		03.3558-0408.3310069	03.3556-1141.2 390434 Verschraubung	
03.2728-2101.3020008	03.0402-1128.2 060027 Rz Reparatursatz		03.3558-0603.3310074	03.3556-1141.2 390434 Verschraubung	
03.2728-2201.3020009	03.0402-1128.2 060027 Rz Reparatursatz		03.3558-0606.3310075	03.3556-1113.2 390428 Verschraubung + WE	
03.3128-1401.3010295	03.0370-1828.2 051828 Hz Reparatursatz		03.3558-0657.3310076	03.3556-1141.2 390434 Verschraubung	
03.3131-2201.3010300	03.0370-1131.2 051131 Hz Reparatursatz		03.3558-0704.3310078	03.3556-1094.2 390427 Verschraubung + WE	
03.3131-2401.3010303	03.0370-1131.2 051131 Hz Reparatursatz		03.3558-0706.3310079	03.3556-1113.2 390428 Verschraubung + WE	
03.3138-2001.3010310	03.0370-1038.2 051038 Hz Reparatursatz 03.0370-9998.2 059998 Hz Rep. Satz,-Kolben		03.7755-3402.4300189	03.0655-0004.2 370004 Wegsensor	
03.3219-0102.3020036	03.0470-2619.2 060051 Rz Dichtungssatz		03.7755-4702.4300224	03.0655-0001.2 370001 Wegsensor	
03.3219-0411.3020038	03.0470-2619.2 060051 Rz Dichtungssatz		03.7848-2002.4300166	03.0655-0007.2 370007 Wegsensor	
03.3231-3401.3020120	03.0401-2031.2 052031 Rz Reparatursatz		03.7848-9402.4300227	03.0655-0007.2 370007 Wegsensor	
03.3241-1801.3020130	03.0403-0341.2 060031 Rz Reparatursatz		03.7858-1932.4300263	03.0655-0007.2 370007 Wegsensor	
03.3241-1802.3020131	03.0403-0341.2 060031 Rz Reparatursatz		03.7858-3032.4300257	03.0655-0001.2 370001 Wegsensor	
03.3508-0100.3310002	03.3556-1164.2 390437 Verschraubung		03.7858-3532.4300233	03.0655-0001.2 370001 Wegsensor	
03.3508-0264.3310009	03.3556-1164.2 390437 Verschraubung		03.7858-3632.4300234	03.0655-0001.2 370001 Wegsensor	
03.3508-0401.3310014	03.3556-1164.2 390437 Verschraubung		03.7858-9502.4300205	03.0655-0006.2 370006 Wegsensor	
03.3508-0500.3310016	03.3556-1164.2 390437 Verschraubung		03.7863-0832.4300229	03.0655-0007.2 370007 Wegsensor	
03.3508-0501.3310017	03.3556-1164.2 390437 Verschraubung		03.7863-0903.4300244	03.0655-0007.2 370007 Wegsensor	
03.3508-0801.3310023	03.3556-1164.2 390437 Verschraubung		03.7863-4132.4300259	03.0655-0007.2 370007 Wegsensor	
			03.7868-4702.4300253	03.0655-0006.2 370006 Wegsensor	

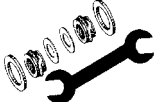





Reparatursätze

Repair kits - Corredi riparazione - Nécessaires de réparation - Juegos de reparación

  	  
03.7873-0202.4 300152 03.0655-0007.2 370007 Wegsensor	11.3351-8502.2 220013 11.0101-5402.2 260009 Hülsensatz
11.1361-0004.2 200001 11.0441-3601.2 250007 Dichtungssatz	11.8116-0015.1 390492 Haltefeder
11.1441-8035.2 200002 11.0441-4402.2 250014 Dichtungssatz	11.8171-0008.1 990049 Führungsbolzen
11.1441-8036.2 200003 11.0441-4402.2 250014 Dichtungssatz	11.3351-8503.2 220014 11.0101-5402.2 260009 Hülsensatz
11.1541-0013.2 200005 11.0441-5401.2 250027 Dichtungssatz	11.8116-0015.1 390492 Haltefeder
11.3331-0033.2 220001 11.0441-3305.2 250006 Dichtungssatz	11.8171-0008.1 990049 Führungsbolzen
11.3331-0034.2 220002 11.0441-3305.2 250006 Dichtungssatz	11.3351-8504.2 220015 11.0101-5402.2 260009 Hülsensatz
11.3331-0037.2 220395 11.0441-3305.2 250006 Dichtungssatz	11.8116-0015.1 390492 Haltefeder
11.3331-0038.2 220396 11.0441-3305.2 250006 Dichtungssatz	11.8171-0008.1 990049 Führungsbolzen
11.3331-0039.2 220387 11.0441-3305.2 250006 Dichtungssatz	11.3361-8503.2 220016 11.0101-5402.2 260009 Hülsensatz
11.3331-0040.2 220388 11.0441-3305.2 250006 Dichtungssatz	11.0441-3602.2 250008 Dichtungssatz
11.3331-8016.2 220003 11.0101-5402.2 260009 Hülsensatz	11.8116-0066.1 390577 Haltefeder
11.3331-8501.2 220004 11.0441-3302.2 250004 Dichtungssatz	11.8171-0008.1 990049 Führungsbolzen
11.3331-8502.2 220005 11.0101-5402.2 260009 Hülsensatz	11.8171-0008.1 990049 Führungsbolzen
11.3331-8502.2 220005 11.0441-3302.2 250004 Dichtungssatz	11.3361-8505.2 220024 11.0101-5402.2 260009 Hülsensatz
11.3331-8502.2 220005 11.8116-0015.1 390492 Haltefeder	11.0441-3602.2 250008 Dichtungssatz
11.3331-8502.2 220005 11.8171-0008.1 990049 Führungsbolzen	11.8116-0185.1 390592 Haltefeder
11.3331-8502.2 220005 11.0101-5402.2 260009 Hülsensatz	11.8171-0008.1 990049 Führungsbolzen
11.3331-8502.2 220005 11.0441-3302.2 250004 Dichtungssatz	11.3361-8506.2 220025 11.0101-5402.2 260009 Hülsensatz
11.3331-8502.2 220005 11.8116-0015.1 390492 Haltefeder	11.0441-3602.2 250008 Dichtungssatz
11.3331-8502.2 220005 11.8171-0008.1 990049 Führungsbolzen	11.8116-0185.1 390592 Haltefeder
11.3331-8502.2 220005 11.0101-5402.2 260009 Hülsensatz	11.8171-0008.1 990049 Führungsbolzen
11.3331-8502.2 220005 11.0441-3302.2 250004 Dichtungssatz	11.3361-9975.2 220281 11.0101-5407.2 260011 Hülsensatz
11.3331-8502.2 220005 11.8116-0015.1 390492 Haltefeder	11.0441-3602.2 250008 Dichtungssatz
11.3331-8502.2 220005 11.8171-0008.1 990049 Führungsbolzen	11.8116-0073.1 390498 Haltefeder
11.3331-8502.2 220005 11.0101-5407.2 260011 Hülsensatz	11.8171-0008.1 990049 Führungsbolzen
11.3331-8502.2 220005 11.0441-3302.2 250004 Dichtungssatz	11.3361-9976.2 220282 11.0101-5407.2 260011 Hülsensatz
11.3331-8502.2 220005 11.8116-0047.1 390494 Haltefeder	11.0441-3602.2 250008 Dichtungssatz
11.3331-8502.2 220005 11.8171-0008.1 990049 Führungsbolzen	11.8116-0073.1 390498 Haltefeder
11.3331-8502.2 220005 11.0101-5407.2 260011 Hülsensatz	11.8171-0008.1 990049 Führungsbolzen
11.3331-8502.2 220005 11.0441-3302.2 250004 Dichtungssatz	11.3381-8501.2 220018 11.0101-5402.2 260009 Hülsensatz
11.3331-8502.2 220005 11.8116-0047.1 390494 Haltefeder	11.0441-3802.2 250009 Dichtungssatz
11.3331-8502.2 220005 11.8171-0008.1 990049 Führungsbolzen	11.8116-0066.1 390577 Haltefeder
11.3331-8502.2 220005 11.0101-5402.2 260009 Hülsensatz	11.8171-0008.1 990049 Führungsbolzen
11.3331-8502.2 220005 11.0441-3303.2 250005 Dichtungssatz	11.3381-8502.2 220019 11.0101-5402.2 260009 Hülsensatz
11.3331-8502.2 220005 11.8116-0047.1 390494 Haltefeder	11.0441-3802.2 250009 Dichtungssatz
11.3331-8502.2 220005 11.8171-0008.1 990049 Führungsbolzen	11.8116-0066.1 390577 Haltefeder
11.3331-8502.2 220005 11.0101-5402.2 260009 Hülsensatz	11.8171-0008.1 990049 Führungsbolzen
11.3331-8502.2 220005 11.0441-3303.2 250005 Dichtungssatz	11.3381-8503.2 220020 11.0101-5402.2 260009 Hülsensatz
11.3331-8502.2 220005 11.8116-0047.1 390494 Haltefeder	11.0441-3803.2 250010 Dichtungssatz
11.3331-8502.2 220005 11.8171-0008.1 990049 Führungsbolzen	11.8116-0066.1 390577 Haltefeder
11.3331-8502.2 220005 11.0101-5402.2 260009 Hülsensatz	11.8171-0008.1 990049 Führungsbolzen
11.3331-8502.2 220005 11.0441-3401.2 250151 Dichtungssatz	11.3381-8504.2 220021 11.0101-5402.2 260009 Hülsensatz
11.3331-8502.2 220005 11.8116-0066.1 390577 Haltefeder	11.0441-3803.2 250010 Dichtungssatz
11.3331-8502.2 220005 11.8171-0008.1 990049 Führungsbolzen	11.8116-0066.1 390577 Haltefeder
11.3331-8502.2 220005 11.0101-5402.2 260009 Hülsensatz	11.8171-0008.1 990049 Führungsbolzen
11.3331-8502.2 220005 11.0441-3401.2 250151 Dichtungssatz	11.3381-8505.2 220022 11.0101-5402.2 260009 Hülsensatz
11.3331-8502.2 220005 11.8116-0066.1 390577 Haltefeder	11.0441-3802.2 250009 Dichtungssatz
11.3331-8502.2 220005 11.8171-0008.1 990049 Führungsbolzen	11.8116-0066.1 390577 Haltefeder
11.3331-8502.2 220005 11.0101-5402.2 260009 Hülsensatz	11.8171-0008.1 990049 Führungsbolzen
11.3331-8502.2 220005 11.0441-3401.2 250151 Dichtungssatz	11.3351-8501.2 220012 11.0101-5402.2 260009 Hülsensatz
11.3331-8502.2 220005 11.8116-0015.1 390492 Haltefeder	11.8116-0015.1 390492 Haltefeder
11.3331-8502.2 220005 11.8171-0008.1 990049 Führungsbolzen	11.8171-0008.1 990049 Führungsbolzen



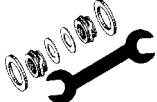

Reparatursätze

Repair kits - Corredi riparazione - Nécessaires de réparation - Juegos de reparación

	 		 
11.3381-8506.2 220023	11.0101-5402.2 260009 Hülsensatz 11.0441-3802.2 250009 Dichtungssatz 11.8116-0066.1 390577 Haltefeder 11.8171-0008.1 990049 Führungsbolzen	11.3401-8514.2 220037	11.0101-5402.2 260009 Hülsensatz 11.0441-4002.2 250011 Dichtungssatz 11.8116-0315.2 390447 Haltefeder 11.8171-0008.1 990049 Führungsbolzen
11.3401-0055.2 220519	11.0101-5407.2 260011 Hülsensatz 11.8116-0143.1 390513 Haltefeder 11.8171-0008.1 990049 Führungsbolzen	11.3421-8501.2 220405	11.0101-6004.2 260014 Hülsensatz 11.8116-0133.1 390511 Haltefeder 11.8171-0008.1 990049 Führungsbolzen
11.3401-0056.2 220520	11.0101-5407.2 260011 Hülsensatz 11.8116-0143.1 390513 Haltefeder 11.8171-0008.1 990049 Führungsbolzen	11.3421-8502.2 220406	11.0101-6004.2 260014 Hülsensatz 11.8116-0133.1 390511 Haltefeder 11.8171-0008.1 990049 Führungsbolzen
11.3401-8501.2 220028	11.0101-5402.2 260009 Hülsensatz 11.0441-4002.2 250011 Dichtungssatz 11.8116-0066.1 390577 Haltefeder 11.8171-0008.1 990049 Führungsbolzen	11.3451-8501.2 220389	11.0101-5407.2 260011 Hülsensatz 11.0101-5409.2 260035 Hülsensatz 11.0441-4502.2 250143 Dichtungssatz 11.8116-0172.1 390500 Haltefeder 11.8171-0008.1 990049 Führungsbolzen
11.3401-8502.2 220029	11.0101-5402.2 260009 Hülsensatz 11.0441-4002.2 250011 Dichtungssatz 11.8116-0066.1 390577 Haltefeder 11.8171-0008.1 990049 Führungsbolzen	11.3451-8502.2 220390	11.0101-5407.2 260011 Hülsensatz 11.0101-5409.2 260035 Hülsensatz 11.0441-4502.2 250143 Dichtungssatz 11.8116-0172.1 390500 Haltefeder 11.8171-0008.1 990049 Führungsbolzen
11.3401-8503.2 220030	11.0101-5402.2 260009 Hülsensatz 11.0441-4002.2 250011 Dichtungssatz 11.8116-0066.1 390577 Haltefeder 11.8171-0008.1 990049 Führungsbolzen	11.3456-8003.2 220038	11.0441-4501.2 250015 Dichtungssatz
11.3401-8504.2 220031	11.0101-5402.2 260009 Hülsensatz 11.0441-4002.2 250011 Dichtungssatz 11.8116-0066.1 390577 Haltefeder 11.8171-0008.1 990049 Führungsbolzen	11.3456-8004.2 220039	11.0441-4501.2 250015 Dichtungssatz
11.3401-8505.2 220032	11.0101-5402.2 260009 Hülsensatz 11.0441-4002.2 250011 Dichtungssatz 11.8116-0094.1 390504 Haltefeder 11.8171-0008.1 990049 Führungsbolzen	11.3481-0106.2 220040	11.0101-4802.2 260007 Hülsensatz 11.0441-4810.2 250023 Dichtungssatz
11.3401-8506.2 220033	11.0101-5402.2 260009 Hülsensatz 11.0441-4002.2 250011 Dichtungssatz 11.8116-0094.1 390504 Haltefeder 11.8171-0008.1 990049 Führungsbolzen	11.3481-0107.2 220041	11.0101-4802.2 260007 Hülsensatz
11.3401-8507.2 220034	11.0101-5402.2 260009 Hülsensatz 11.0441-4002.2 250011 Dichtungssatz 11.8116-0296.1 390445 Haltefeder 11.8171-0008.1 990049 Führungsbolzen	11.3481-0108.2 220042	11.0101-4802.2 260007 Hülsensatz
11.3401-8508.2 220035	11.0101-5402.2 260009 Hülsensatz 11.0441-4002.2 250011 Dichtungssatz 11.8116-0296.1 390445 Haltefeder 11.8171-0008.1 990049 Führungsbolzen	11.3481-0167.2 220285	11.0101-5407.2 260011 Hülsensatz 11.0441-4811.2 250024 Dichtungssatz
11.3401-8511.2 220026	11.0101-5402.2 260009 Hülsensatz 11.0441-4002.2 250011 Dichtungssatz 11.8116-0296.1 390445 Haltefeder 11.8171-0008.1 990049 Führungsbolzen	11.3481-0168.2 220286	11.0101-5407.2 260011 Hülsensatz 11.0441-4811.2 250024 Dichtungssatz
11.3401-8512.2 220027	11.0101-5402.2 260009 Hülsensatz 11.0441-4002.2 250011 Dichtungssatz 11.8116-0296.1 390445 Haltefeder 11.8171-0008.1 990049 Führungsbolzen	11.3481-8014.2 220045	11.0101-4802.2 260007 Hülsensatz 11.0441-4803.2 250018 Dichtungssatz
11.3401-8513.2 220036	11.0101-5402.2 260009 Hülsensatz 11.0441-4002.2 250011 Dichtungssatz 11.8116-0315.2 390447 Haltefeder 11.8171-0008.1 990049 Führungsbolzen	11.3481-8015.2 220046	11.0101-4802.2 260007 Hülsensatz 11.0441-4803.2 250018 Dichtungssatz
		11.3481-8016.2 220047	11.0101-4802.2 260007 Hülsensatz 11.0441-4803.2 250018 Dichtungssatz
		11.3481-8029.2 220048	11.0101-4802.2 260007 Hülsensatz 11.0441-4803.2 250018 Dichtungssatz
		11.3481-8030.2 220049	11.0101-4802.2 260007 Hülsensatz 11.0441-4803.2 250018 Dichtungssatz
		11.3481-8037.2 220050	11.0101-5407.2 260011 Hülsensatz 11.0441-4805.2 250020 Dichtungssatz 11.8171-0008.1 990049 Führungsbolzen
		11.3481-8038.2 220051	11.0101-5407.2 260011 Hülsensatz 11.0441-4805.2 250020 Dichtungssatz 11.8171-0008.1 990049 Führungsbolzen
		11.3481-8075.2 220053	11.0101-5407.2 260011 Hülsensatz 11.0441-4811.2 250024 Dichtungssatz 11.8171-0008.1 990049 Führungsbolzen

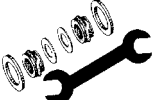

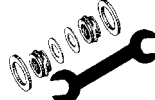



Reparatursätze

Repair kits - Corredi riparazione - Nécessaires de réparation - Juegos de reparación

	 		 
11.3481-8076.2 220054	11.0101-5407.2 260011 Hülsensatz 11.0441-4811.2 250024 Dichtungssatz 11.8171-0008.1 990049 Führungsbolzen	11.3481-8513.2 220335	11.0101-5407.2 260011 Hülsensatz 11.0230-0687.1 260106 Halter 11.0441-4805.2 250020 Dichtungssatz 11.8116-0264.1 390594 Haltefeder 11.8171-0008.1 990049 Führungsbolzen
11.3481-8083.2 220057	11.0101-5407.2 260011 Hülsensatz 11.0441-4811.2 250024 Dichtungssatz 11.8116-0129.1 390591 Haltefeder 11.8171-0008.1 990049 Führungsbolzen	11.3481-8514.2 220336	11.0101-5407.2 260011 Hülsensatz 11.0230-0687.1 260106 Halter 11.0441-4805.2 250020 Dichtungssatz 11.8116-0264.1 390594 Haltefeder 11.8171-0008.1 990049 Führungsbolzen
11.3481-8084.2 220058	11.0101-5407.2 260011 Hülsensatz 11.0441-4811.2 250024 Dichtungssatz 11.8116-0129.1 390591 Haltefeder 11.8171-0008.1 990049 Führungsbolzen	11.3481-8515.2 220365	11.0101-5407.2 260011 Hülsensatz 11.8116-0264.1 390594 Haltefeder 11.8171-0008.1 990049 Führungsbolzen
11.3481-8085.2 220059	11.0101-5407.2 260011 Hülsensatz 11.0441-4811.2 250024 Dichtungssatz 11.8116-0129.1 390591 Haltefeder 11.8171-0008.1 990049 Führungsbolzen	11.3481-8516.2 220366	11.0101-5407.2 260011 Hülsensatz 11.8116-0264.1 390594 Haltefeder 11.8171-0008.1 990049 Führungsbolzen
11.3481-8086.2 220060	11.0101-5407.2 260011 Hülsensatz 11.0441-4811.2 250024 Dichtungssatz 11.8116-0129.1 390591 Haltefeder 11.8171-0008.1 990049 Führungsbolzen	11.3481-9833.2 220561	11.0101-5407.2 260011 Hülsensatz 11.0441-4811.2 250024 Dichtungssatz 11.8116-0129.1 390591 Haltefeder 11.8171-0008.1 990049 Führungsbolzen
11.3481-8503.2 220061	11.0101-4801.2 260006 Hülsensatz 11.0441-4804.2 250019 Dichtsa. (+Sich.Ring) 11.0441-4808.2 250022 Dichtungssatz 24.0102-4801.2 260085 Hülsensatz+Schrauben	11.3481-9834.2 220562	11.0101-5407.2 260011 Hülsensatz 11.0441-4811.2 250024 Dichtungssatz 11.8116-0129.1 390591 Haltefeder 11.8171-0008.1 990049 Führungsbolzen
11.3481-8504.2 220062	11.0101-4801.2 260006 Hülsensatz 11.0441-4804.2 250019 Dichtsa. (+Sich.Ring) 11.0441-4808.2 250022 Dichtungssatz 24.0102-4801.2 260085 Hülsensatz+Schrauben	11.3521-8003.2 220070	11.0101-4802.2 260007 Hülsensatz
11.3481-8505.2 220063	11.0101-5407.2 260011 Hülsensatz 11.0441-4805.2 250020 Dichtungssatz 11.8171-0008.1 990049 Führungsbolzen	11.3521-8004.2 220071	11.0101-4802.2 260007 Hülsensatz
11.3481-8506.2 220064	11.0101-5407.2 260011 Hülsensatz 11.0441-4805.2 250020 Dichtungssatz 11.8171-0008.1 990049 Führungsbolzen	11.3521-8011.2 220072	11.0441-5202.2 250026 Dichtungssatz
11.3481-8507.2 220065	11.0101-5402.2 260009 Hülsensatz 11.0441-4810.2 250023 Dichtungssatz 11.8171-0008.1 990049 Führungsbolzen	11.3521-8012.2 220073	11.0441-5202.2 250026 Dichtungssatz
11.3481-8508.2 220066	11.0101-5402.2 260009 Hülsensatz 11.0441-4810.2 250023 Dichtungssatz 11.8171-0008.1 990049 Führungsbolzen	11.3521-8501.2 220391	11.0101-5407.2 260011 Hülsensatz 11.0101-5409.2 260035 Hülsensatz 11.0441-5203.2 250144 Dichtungssatz 11.8116-0191.1 390522 Haltefeder 11.8171-0008.1 990049 Führungsbolzen
11.3481-8509.2 220329	11.0101-4801.2 260006 Hülsensatz 11.0441-4808.2 250022 Dichtungssatz 24.0102-4801.2 260085 Hülsensatz+Schrauben	11.3521-8502.2 220392	11.0101-5407.2 260011 Hülsensatz 11.0101-5409.2 260035 Hülsensatz 11.0441-5203.2 250144 Dichtungssatz 11.8116-0191.1 390522 Haltefeder 11.8171-0008.1 990049 Führungsbolzen
11.3481-8510.2 220330	11.0101-4801.2 260006 Hülsensatz 11.0441-4808.2 250022 Dichtungssatz 24.0102-4801.2 260085 Hülsensatz+Schrauben	11.3541-0257.2 220074	11.0101-5407.2 260011 Hülsensatz 11.8171-0008.1 990049 Führungsbolzen
11.3481-8511.2 220337	11.0101-5407.2 260011 Hülsensatz 11.0441-4805.2 250020 Dichtungssatz 11.8171-0008.1 990049 Führungsbolzen	11.3541-0258.2 220075	11.0101-5407.2 260011 Hülsensatz 11.8171-0008.1 990049 Führungsbolzen
11.3481-8512.2 220338	11.0101-5407.2 260011 Hülsensatz 11.0441-4805.2 250020 Dichtungssatz 11.8171-0008.1 990049 Führungsbolzen	11.3541-8017.2 220076	11.0101-5407.2 260011 Hülsensatz 11.0441-5402.2 250028 Dichtungssatz 11.8171-0008.1 990049 Führungsbolzen
		11.3541-8018.2 220077	11.0101-5407.2 260011 Hülsensatz 11.0441-5402.2 250028 Dichtungssatz 11.8171-0008.1 990049 Führungsbolzen
		11.3541-8039.2 220078	11.0441-5404.2 250029 Dichtungssatz
		11.3541-8040.2 220079	11.0441-5404.2 250029 Dichtungssatz



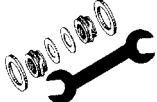

Reparatursätze

Repair kits - Corredi riparazione - Nécessaires de réparation - Juegos de reparación

	 		 
11.3541-8045.2 220080	11.0101-5407.2 260011 Hülsensatz 11.0441-5405.2 250030 Dichtungssatz 11.8171-0008.1 990049 Führungsbolzen	11.3541-8106.2 220340	11.0101-5407.2 260011 Hülsensatz 11.8171-0008.1 990049 Führungsbolzen
11.3541-8061.2 220081	11.0101-5407.2 260011 Hülsensatz 11.0441-5402.2 250028 Dichtungssatz 11.8171-0008.1 990049 Führungsbolzen	11.3541-8501.2 220093	11.0101-5409.2 260035 Hülsensatz 11.0441-5405.2 250030 Dichtungssatz 11.8171-0008.1 990049 Führungsbolzen
11.3541-8062.2 220082	11.0101-5407.2 260011 Hülsensatz 11.0441-5402.2 250028 Dichtungssatz 11.8171-0008.1 990049 Führungsbolzen	11.3541-8502.2 220094	11.0101-5409.2 260035 Hülsensatz 11.0441-5405.2 250030 Dichtungssatz 11.8171-0008.1 990049 Führungsbolzen
11.3541-8065.2 220083	11.0441-5404.2 250029 Dichtungssatz	11.3541-8503.2 220095	11.0101-5409.2 260035 Hülsensatz 11.0441-5405.2 250030 Dichtungssatz 11.8171-0008.1 990049 Führungsbolzen
11.3541-8066.2 220084	11.0441-5404.2 250029 Dichtungssatz	11.3541-8504.2 220096	11.0101-5409.2 260035 Hülsensatz 11.0441-5405.2 250030 Dichtungssatz 11.8171-0008.1 990049 Führungsbolzen
11.3541-8067.2 220085	11.0101-5407.2 260011 Hülsensatz 11.0441-5405.2 250030 Dichtungssatz	11.3541-8505.2 220097	11.0101-5407.2 260011 Hülsensatz 11.0441-5402.2 250028 Dichtungssatz 11.8171-0008.1 990049 Führungsbolzen
11.3541-8068.2 220086	11.0101-5407.2 260011 Hülsensatz 11.0441-5405.2 250030 Dichtungssatz	11.3541-8506.2 220098	11.0101-5407.2 260011 Hülsensatz 11.0441-5402.2 250028 Dichtungssatz 11.8171-0008.1 990049 Führungsbolzen
11.3541-8083.2 220241	11.0101-5407.2 260011 Hülsensatz 11.8116-0292.1 390521 Haltefeder 11.8171-0008.1 990049 Führungsbolzen	11.3541-8507.2 220099	11.0101-5407.2 260011 Hülsensatz 11.0441-5402.2 250028 Dichtungssatz 11.8171-0008.1 990049 Führungsbolzen
11.3541-8084.2 220242	11.0101-5407.2 260011 Hülsensatz 11.8116-0292.1 390521 Haltefeder 11.8171-0008.1 990049 Führungsbolzen	11.3541-8508.2 220100	11.0101-5407.2 260011 Hülsensatz 11.0441-5402.2 250028 Dichtungssatz 11.8171-0008.1 990049 Führungsbolzen
11.3541-8085.2 220287	11.0101-5407.2 260011 Hülsensatz 11.8116-0129.1 390591 Haltefeder 11.8116-0292.1 390521 Haltefeder 11.8171-0008.1 990049 Führungsbolzen	11.3541-8509.2 220101	11.0101-5407.2 260011 Hülsensatz 11.0441-5402.2 250028 Dichtungssatz 11.8171-0008.1 990049 Führungsbolzen
11.3541-8086.2 220288	11.0101-5407.2 260011 Hülsensatz 11.8116-0129.1 390591 Haltefeder 11.8116-0292.1 390521 Haltefeder 11.8171-0008.1 990049 Führungsbolzen	11.3541-8510.2 220102	11.0101-5407.2 260011 Hülsensatz 11.0441-5402.2 250028 Dichtungssatz 11.8171-0008.1 990049 Führungsbolzen
11.3541-8089.2 220087	11.0101-5407.2 260011 Hülsensatz 11.0441-5402.2 250028 Dichtungssatz 11.8171-0008.1 990049 Führungsbolzen	11.3541-8511.2 220103	11.0101-5402.2 260009 Hülsensatz 11.0441-5402.2 250028 Dichtungssatz 11.8116-0091.1 390502 Haltefeder 11.8171-0008.1 990049 Führungsbolzen
11.3541-8090.2 220088	11.0101-5407.2 260011 Hülsensatz 11.0441-5402.2 250028 Dichtungssatz 11.8171-0008.1 990049 Führungsbolzen	11.3541-8512.2 220104	11.0101-5402.2 260009 Hülsensatz 11.0441-5402.2 250028 Dichtungssatz 11.8116-0091.1 390502 Haltefeder 11.8171-0008.1 990049 Führungsbolzen
11.3541-8091.2 220089	11.0101-5407.2 260011 Hülsensatz 11.0441-5402.2 250028 Dichtungssatz 11.8171-0008.1 990049 Führungsbolzen	11.3541-8513.2 220105	11.0101-5402.2 260009 Hülsensatz 11.0441-5402.2 250028 Dichtungssatz 11.8170-0729.1 260107 Halter 11.8171-0008.1 990049 Führungsbolzen
11.3541-8092.2 220090	11.0101-5407.2 260011 Hülsensatz 11.0441-5402.2 250028 Dichtungssatz 11.8171-0008.1 990049 Führungsbolzen	11.3541-8514.2 220106	11.0101-5402.2 260009 Hülsensatz 11.0441-5402.2 250028 Dichtungssatz 11.8170-0729.1 260107 Halter 11.8171-0008.1 990049 Führungsbolzen
11.3541-8101.2 220091	11.0101-5407.2 260011 Hülsensatz 11.0441-5402.2 250028 Dichtungssatz 11.8116-0097.1 390590 Haltefeder 11.8171-0008.1 990049 Führungsbolzen	11.3541-8515.2 220107	11.0101-5402.2 260009 Hülsensatz 11.0441-5402.2 250028 Dichtungssatz 11.8171-0008.1 990049 Führungsbolzen
11.3541-8102.2 220092	11.0101-5407.2 260011 Hülsensatz 11.0441-5402.2 250028 Dichtungssatz 11.8116-0097.1 390590 Haltefeder 11.8171-0008.1 990049 Führungsbolzen		
11.3541-8105.2 220339	11.0101-5407.2 260011 Hülsensatz 11.8171-0008.1 990049 Führungsbolzen		

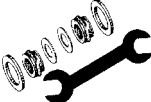

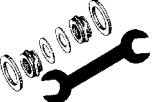



Reparatursätze

Repair kits - Corredi riparazione - Nécessaires de réparation - Juegos de reparación

	 		 
11.3541-8516.2 220108	11.0101-5402.2 260009 Hülsensatz 11.0441-5402.2 250028 Dichtungssatz 11.8171-0008.1 990049 Führungsbolzen	11.3571-8009.2 220119	11.0101-5407.2 260011 Hülsensatz 11.0441-5702.2 250033 Dichtungssatz
11.3541-8517.2 220109	11.0101-5402.2 260009 Hülsensatz 11.0441-5402.2 250028 Dichtungssatz 11.8116-0091.1 390502 Haltefeder 11.8171-0008.1 990049 Führungsbolzen	11.3571-8010.2 220120	11.0101-5407.2 260011 Hülsensatz 11.0441-5702.2 250033 Dichtungssatz
11.3541-8518.2 220110	11.0101-5402.2 260009 Hülsensatz 11.0441-5402.2 250028 Dichtungssatz 11.8116-0091.1 390502 Haltefeder 11.8171-0008.1 990049 Führungsbolzen	11.3571-8501.2 220121	11.0101-5402.2 260009 Hülsensatz 11.0101-5407.2 260011 Hülsensatz 11.0441-5702.2 250033 Dichtungssatz 11.8116-0091.1 390502 Haltefeder 11.8171-0008.1 990049 Führungsbolzen
11.3541-8519.2 220111	11.0101-5409.2 260035 Hülsensatz 11.0441-5405.2 250030 Dichtungssatz	11.3571-8502.2 220122	11.0101-5402.2 260009 Hülsensatz 11.0101-5407.2 260011 Hülsensatz 11.0441-5702.2 250033 Dichtungssatz 11.8116-0091.1 390502 Haltefeder 11.8171-0008.1 990049 Führungsbolzen
11.3541-8520.2 220112	11.0101-5409.2 260035 Hülsensatz 11.0441-5405.2 250030 Dichtungssatz	11.3571-8503.2 220123	11.0101-5402.2 260009 Hülsensatz 11.0441-5702.2 250033 Dichtungssatz 11.8116-0091.1 390502 Haltefeder 11.8171-0008.1 990049 Führungsbolzen
11.3541-8521.2 220113	11.0101-5409.2 260035 Hülsensatz 11.0441-5405.2 250030 Dichtungssatz	11.3571-8504.2 220124	11.0101-5402.2 260009 Hülsensatz 11.0441-5702.2 250033 Dichtungssatz 11.8116-0091.1 390502 Haltefeder 11.8171-0008.1 990049 Führungsbolzen
11.3541-8522.2 220114	11.0101-5409.2 260035 Hülsensatz 11.0441-5405.2 250030 Dichtungssatz	11.3571-8505.2 220125	11.0101-5409.2 260035 Hülsensatz 11.0441-5704.2 250034 Dichtungssatz 11.8116-0143.1 390513 Haltefeder 11.8171-0008.1 990049 Führungsbolzen
11.3541-8523.2 220115	11.0101-5409.2 260035 Hülsensatz 11.0441-5409.2 250031 Dichtungssatz 11.8116-0143.1 390513 Haltefeder 11.8170-0306.1 260102 Halter 11.8171-0008.1 990049 Führungsbolzen	11.3571-8506.2 220126	11.0101-5409.2 260035 Hülsensatz 11.0441-5704.2 250034 Dichtungssatz 11.8116-0143.1 390513 Haltefeder 11.8171-0008.1 990049 Führungsbolzen
11.3541-8524.2 220116	11.0101-5409.2 260035 Hülsensatz 11.0441-5409.2 250031 Dichtungssatz 11.8116-0143.1 390513 Haltefeder 11.8170-0306.1 260102 Halter 11.8171-0008.1 990049 Führungsbolzen	11.3571-8507.2 220127	11.0101-5409.2 260035 Hülsensatz 11.0441-5704.2 250034 Dichtungssatz 11.8116-0143.1 390513 Haltefeder 11.8170-0306.1 260102 Halter 11.8171-0008.1 990049 Führungsbolzen
11.3541-8529.2 220341	11.0101-5407.2 260011 Hülsensatz 11.0441-5402.2 250028 Dichtungssatz 11.8116-0264.1 390594 Haltefeder 11.8171-0008.1 990049 Führungsbolzen	11.3571-8508.2 220128	11.0101-5409.2 260035 Hülsensatz 11.0441-5704.2 250034 Dichtungssatz 11.8116-0143.1 390513 Haltefeder 11.8170-0306.1 260102 Halter 11.8171-0008.1 990049 Führungsbolzen
11.3541-8530.2 220342	11.0101-5407.2 260011 Hülsensatz 11.0441-5402.2 250028 Dichtungssatz 11.8116-0264.1 390594 Haltefeder 11.8171-0008.1 990049 Führungsbolzen	11.3571-8509.2 220313	11.0101-5407.2 260011 Hülsensatz 11.0441-5703.2 250145 Dichtungssatz 11.8116-0253.1 390512 Haltefeder 11.8171-0008.1 990049 Führungsbolzen
11.3541-8531.2 220367	11.0101-5407.2 260011 Hülsensatz 11.8116-0264.1 390594 Haltefeder 11.8116-0356.1 390586 Haltefeder 11.8171-0008.1 990049 Führungsbolzen	11.3571-8510.2 220314	11.0101-5407.2 260011 Hülsensatz 11.0441-5703.2 250145 Dichtungssatz 11.8116-0253.1 390512 Haltefeder 11.8171-0008.1 990049 Führungsbolzen
11.3541-8532.2 220368	11.0101-5407.2 260011 Hülsensatz 11.8116-0264.1 390594 Haltefeder 11.8116-0356.1 390586 Haltefeder 11.8171-0008.1 990049 Führungsbolzen	11.3571-8511.2 220315	11.0101-5407.2 260011 Hülsensatz 11.0441-5703.2 250145 Dichtungssatz 11.8116-0253.1 390512 Haltefeder 11.8170-0401.1 260103 Halter 11.8171-0008.1 990049 Führungsbolzen
11.3571-8007.2 220117	11.0101-5407.2 260011 Hülsensatz 11.0441-5702.2 250033 Dichtungssatz 11.8116-0073.1 390498 Haltefeder 11.8171-0008.1 990049 Führungsbolzen		
11.3571-8008.2 220118	11.0101-5407.2 260011 Hülsensatz 11.0441-5702.2 250033 Dichtungssatz 11.8116-0073.1 390498 Haltefeder 11.8171-0008.1 990049 Führungsbolzen		



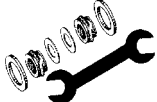

Reparatursätze

Repair kits - Corredi riparazione - Nécessaires de réparation - Juegos de reparación

	 		 
11.3571-8512.2 220316	11.0101-5407.2 260011 Hülsensatz 11.0441-5703.2 250145 Dichtungssatz 11.8116-0253.1 390512 Haltefeder 11.8170-0401.1 260103 Halter 11.8171-0008.1 990049 Führungsbolzen	11.3601-0073.2 220131	11.0101-5407.2 260011 Hülsensatz 11.0441-6003.2 250037 Dichtungssatz 11.8171-0008.1 990049 Führungsbolzen
11.3571-8515.2 220333	11.0101-5409.2 260035 Hülsensatz 11.0441-5704.2 250034 Dichtungssatz 11.8116-0237.1 390509 Haltefeder 11.8171-0008.1 990049 Führungsbolzen	11.3601-0074.2 220132	11.0101-5407.2 260011 Hülsensatz 11.0441-6003.2 250037 Dichtungssatz 11.8171-0008.1 990049 Führungsbolzen
11.3571-8516.2 220334	11.0101-5409.2 260035 Hülsensatz 11.0441-5704.2 250034 Dichtungssatz 11.8116-0237.1 390509 Haltefeder 11.8171-0008.1 990049 Führungsbolzen	11.3601-8001.2 220133	11.0101-5407.2 260011 Hülsensatz 11.0441-6003.2 250037 Dichtungssatz 11.8116-0052.1 390496 Haltefeder 11.8171-0008.1 990049 Führungsbolzen
11.3571-8517.2 220321	11.0101-5409.2 260035 Hülsensatz 11.0441-5704.2 250034 Dichtungssatz 11.8116-0143.1 390513 Haltefeder 11.8171-0008.1 990049 Führungsbolzen	11.3601-8002.2 220134	11.0101-5407.2 260011 Hülsensatz 11.0441-6003.2 250037 Dichtungssatz 11.8116-0052.1 390496 Haltefeder 11.8171-0008.1 990049 Führungsbolzen
11.3571-8518.2 220322	11.0101-5409.2 260035 Hülsensatz 11.0441-5704.2 250034 Dichtungssatz 11.8116-0143.1 390513 Haltefeder 11.8171-0008.1 990049 Führungsbolzen	11.3601-8049.3 220327	11.0441-6007.2 250146 Dichtungssatz
11.3571-8521.2 220319	11.0101-5409.2 260035 Hülsensatz 11.0441-5704.2 250034 Dichtungssatz 11.8116-0143.1 390513 Haltefeder 11.8170-0306.1 260102 Halter 11.8171-0008.1 990049 Führungsbolzen	11.3601-8050.3 220328	11.0441-6007.2 250146 Dichtungssatz
11.3571-8522.2 220320	11.0101-5409.2 260035 Hülsensatz 11.0441-5704.2 250034 Dichtungssatz 11.8116-0143.1 390513 Haltefeder 11.8170-0306.1 260102 Halter 11.8171-0008.1 990049 Führungsbolzen	11.3601-8063.2 220135	11.0101-5407.2 260011 Hülsensatz 11.0441-6007.2 250146 Dichtungssatz 11.8116-0073.1 390498 Haltefeder 11.8171-0008.1 990049 Führungsbolzen
11.3571-8523.2 220343	11.0101-5409.2 260035 Hülsensatz 11.0441-5704.2 250034 Dichtungssatz 11.8116-0143.1 390513 Haltefeder 11.8171-0008.1 990049 Führungsbolzen	11.3601-8064.2 220136	11.0101-5407.2 260011 Hülsensatz 11.0441-6007.2 250146 Dichtungssatz 11.8116-0073.1 390498 Haltefeder 11.8171-0008.1 990049 Führungsbolzen
11.3571-8524.2 220344	11.0101-5407.2 260011 Hülsensatz 11.0101-5409.2 260035 Hülsensatz 11.0441-5704.2 250034 Dichtungssatz 11.8116-0143.1 390513 Haltefeder 11.8171-0008.1 990049 Führungsbolzen	11.3601-8065.2 220137	11.0101-5407.2 260011 Hülsensatz 11.0441-6003.2 250037 Dichtungssatz 11.8171-0008.1 990049 Führungsbolzen
11.3571-8525.2 220363	11.0101-5407.2 260011 Hülsensatz 11.0441-5704.2 250034 Dichtungssatz 11.8116-0292.1 390521 Haltefeder 11.8171-0008.1 990049 Führungsbolzen	11.3601-8066.2 220138	11.0101-5407.2 260011 Hülsensatz 11.0441-6003.2 250037 Dichtungssatz 11.8171-0008.1 990049 Führungsbolzen
11.3571-8526.2 220364	11.0101-5407.2 260011 Hülsensatz 11.0441-5704.2 250034 Dichtungssatz 11.8116-0292.1 390521 Haltefeder 11.8171-0008.1 990049 Führungsbolzen	11.3601-8067.2 220139	11.0101-5407.2 260011 Hülsensatz 11.0441-6007.2 250146 Dichtungssatz 11.8171-0008.1 990049 Führungsbolzen
11.3601-0011.2 220129	11.0101-5407.2 260011 Hülsensatz 11.0441-5704.2 250034 Dichtungssatz 11.8116-0292.1 390521 Haltefeder 11.8171-0008.1 990049 Führungsbolzen	11.3601-8068.2 220140	11.0101-5407.2 260011 Hülsensatz 11.0441-6007.2 250146 Dichtungssatz 11.8171-0008.1 990049 Führungsbolzen
11.3601-0012.2 220130	11.0101-5407.2 260011 Hülsensatz 11.0441-6003.2 250037 Dichtungssatz 11.8171-0008.1 990049 Führungsbolzen	11.3601-8071.2 220141	11.0101-5407.2 260011 Hülsensatz 11.0230-0170.2 260078 Haltersatz 11.0441-6007.2 250146 Dichtungssatz 11.8171-0008.1 990049 Führungsbolzen
		11.3601-8072.2 220142	11.0101-5407.2 260011 Hülsensatz 11.0230-0170.2 260078 Haltersatz 11.0441-6007.2 250146 Dichtungssatz 11.8171-0008.1 990049 Führungsbolzen
		11.3601-8073.2 220143	11.0101-5407.2 260011 Hülsensatz 11.0441-6007.2 250146 Dichtungssatz 11.8171-0008.1 990049 Führungsbolzen
		11.3601-8074.2 220144	11.0101-5407.2 260011 Hülsensatz 11.0441-6007.2 250146 Dichtungssatz 11.8171-0008.1 990049 Führungsbolzen

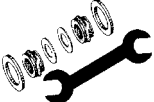

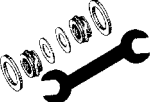



Reparatursätze

Repair kits - Corredi riparazione - Nécessaires de réparation - Juegos de reparación

	 		 
11.3601-8501.2 220145	11.0101-5402.2 260009 Hülsensatz 11.0230-0020.2 260023 Haltersatz 11.0441-6003.2 250037 Dichtungssatz 11.8116-0083.1 390501 Haltefeder 11.8171-0008.1 990049 Führungsbolzen	11.3601-8515.2 220323	11.0101-5402.2 260009 Hülsensatz 11.0441-6003.2 250037 Dichtungssatz 11.8116-0083.1 390501 Haltefeder 11.8171-0008.1 990049 Führungsbolzen
11.3601-8502.2 220146	11.0101-5402.2 260009 Hülsensatz 11.0230-0020.2 260023 Haltersatz 11.0441-6003.2 250037 Dichtungssatz 11.8116-0083.1 390501 Haltefeder 11.8171-0008.1 990049 Führungsbolzen	11.3601-8516.2 220324	11.0101-5402.2 260009 Hülsensatz 11.0441-6003.2 250037 Dichtungssatz 11.8116-0083.1 390501 Haltefeder 11.8171-0008.1 990049 Führungsbolzen
11.3601-8503.2 220147	11.0101-5402.2 260009 Hülsensatz 11.0441-6003.2 250037 Dichtungssatz 11.8116-0083.1 390501 Haltefeder 11.8171-0008.1 990049 Führungsbolzen	11.3601-8519.2 220345	11.0101-5407.2 260011 Hülsensatz 11.0441-6007.2 250146 Dichtungssatz 11.8116-0073.1 390498 Haltefeder 11.8171-0008.1 990049 Führungsbolzen
11.3601-8504.2 220148	11.0101-5402.2 260009 Hülsensatz 11.0441-6003.2 250037 Dichtungssatz 11.8116-0083.1 390501 Haltefeder 11.8171-0008.1 990049 Führungsbolzen	11.3601-8520.2 220346	11.0101-5407.2 260011 Hülsensatz 11.0441-6007.2 250146 Dichtungssatz 11.8116-0073.1 390498 Haltefeder 11.8171-0008.1 990049 Führungsbolzen
11.3601-8505.2 220149	11.0101-5402.2 260009 Hülsensatz 11.0441-6003.2 250037 Dichtungssatz 11.8116-0083.1 390501 Haltefeder 11.8171-0008.1 990049 Führungsbolzen	11.3601-8521.2 220347	11.0101-5407.2 260011 Hülsensatz 11.0441-6003.2 250037 Dichtungssatz 11.8116-0052.1 390496 Haltefeder 11.8171-0008.1 990049 Führungsbolzen
11.3601-8506.2 220150	11.0101-5402.2 260009 Hülsensatz 11.0441-6003.2 250037 Dichtungssatz 11.8116-0083.1 390501 Haltefeder 11.8171-0008.1 990049 Führungsbolzen	11.3601-8522.2 220348	11.0101-5407.2 260011 Hülsensatz 11.0441-6003.2 250037 Dichtungssatz 11.8116-0052.1 390496 Haltefeder 11.8171-0008.1 990049 Führungsbolzen
11.3601-8507.2 220151	11.0101-5407.2 260011 Hülsensatz 11.0441-6003.2 250037 Dichtungssatz 11.8116-0052.1 390496 Haltefeder 11.8171-0008.1 990049 Führungsbolzen	11.3601-8523.2 220349	11.0101-5407.2 260011 Hülsensatz 11.0441-6007.2 250146 Dichtungssatz 11.8116-0073.1 390498 Haltefeder 11.8171-0008.1 990049 Führungsbolzen
11.3601-8508.2 220152	11.0101-5407.2 260011 Hülsensatz 11.0441-6003.2 250037 Dichtungssatz 11.8116-0052.1 390496 Haltefeder 11.8171-0008.1 990049 Führungsbolzen	11.3601-8524.2 220350	11.0101-5407.2 260011 Hülsensatz 11.0441-6007.2 250146 Dichtungssatz 11.8116-0073.1 390498 Haltefeder 11.8171-0008.1 990049 Führungsbolzen
11.3601-8509.2 220153	11.0101-6004.2 260014 Hülsensatz 11.0441-6003.2 250037 Dichtungssatz	11.3601-8525.2 220351	11.0101-5407.2 260011 Hülsensatz 11.0441-6007.2 250146 Dichtungssatz 11.8116-0143.1 390513 Haltefeder 11.8171-0008.1 990049 Führungsbolzen
11.3601-8510.2 220154	11.0101-6004.2 260014 Hülsensatz 11.0441-6003.2 250037 Dichtungssatz	11.3601-8526.2 220352	11.0101-5407.2 260011 Hülsensatz 11.0441-6007.2 250146 Dichtungssatz 11.8116-0143.1 390513 Haltefeder 11.8171-0008.1 990049 Führungsbolzen
11.3601-8511.2 220155	11.0101-5402.2 260009 Hülsensatz 11.0441-6003.2 250037 Dichtungssatz 11.8116-0092.1 390503 Haltefeder 11.8171-0008.1 990049 Führungsbolzen	11.3601-8527.2 220353	11.0101-5407.2 260011 Hülsensatz 11.0230-0170.2 260078 Haltersatz 11.0441-6007.2 250146 Dichtungssatz 11.8116-0301.1 390610 Haltefeder 11.8171-0008.1 990049 Führungsbolzen
11.3601-8512.2 220156	11.0101-5402.2 260009 Hülsensatz 11.0441-6003.2 250037 Dichtungssatz 11.8116-0092.1 390503 Haltefeder 11.8171-0008.1 990049 Führungsbolzen	11.3601-8528.2 220354	11.0101-5407.2 260011 Hülsensatz 11.0230-0170.2 260078 Haltersatz 11.0441-6007.2 250146 Dichtungssatz 11.8116-0301.1 390610 Haltefeder 11.8171-0008.1 990049 Führungsbolzen
11.3601-8513.2 220393	11.0101-5704.2 260095 Hülsensatz 11.0441-6007.2 250146 Dichtungssatz 11.8116-0200.1 390505 Haltefeder 11.8171-0008.1 990049 Führungsbolzen	11.3601-8529.2 220355	11.0101-5407.2 260011 Hülsensatz 11.0441-6007.2 250146 Dichtungssatz 11.8171-0008.1 990049 Führungsbolzen
11.3601-8514.2 220394	11.0101-5704.2 260095 Hülsensatz 11.0441-6007.2 250146 Dichtungssatz 11.8116-0200.1 390505 Haltefeder 11.8171-0008.1 990049 Führungsbolzen	11.3601-8530.2 220356	11.0101-5407.2 260011 Hülsensatz 11.0441-6007.2 250146 Dichtungssatz 11.8171-0008.1 990049 Führungsbolzen



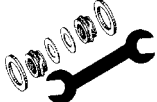

Reparatursätze

Repair kits - Corredi riparazione - Nécessaires de réparation - Juegos de reparación

	 		 
11.4601-8001.3 220157	11.0441-6002.2 250036 Dichtungssatz	11.9381-9961.2 220435	11.0101-5402.2 260009 Hülsensatz 11.0441-3803.2 250010 Dichtungssatz 11.8116-0066.1 390577 Haltefeder 11.8171-0008.1 990049 Führungsbolzen
11.4601-8002.3 220158	11.0441-6002.2 250036 Dichtungssatz	11.9381-9962.2 220436	11.0101-5402.2 260009 Hülsensatz 11.0441-3803.2 250010 Dichtungssatz 11.8116-0066.1 390577 Haltefeder 11.8171-0008.1 990049 Führungsbolzen
11.4601-8003.3 220159	11.0441-6002.2 250036 Dichtungssatz	11.9382-7003.2 220891	11.0103-0001.2 250156 Bremssattel-Zubehör
11.4601-8004.3 220160	11.0441-6002.2 250036 Dichtungssatz	11.9382-7004.2 220892	11.0103-0001.2 250156 Bremssattel-Zubehör
11.9341-9991.2 220407	11.0101-5402.2 260009 Hülsensatz 11.0441-3401.2 250151 Dichtungssatz 11.8116-0185.1 390592 Haltefeder 11.8171-0008.1 990049 Führungsbolzen	11.9387-7001.2 220397	11.0101-5407.2 260011 Hülsensatz 11.8116-0340.1 390595 Haltefeder 11.8171-0008.1 990049 Führungsbolzen
11.9341-9992.2 220408	11.0101-5402.2 260009 Hülsensatz 11.0441-3401.2 250151 Dichtungssatz 11.8116-0185.1 390592 Haltefeder 11.8171-0008.1 990049 Führungsbolzen	11.9387-7002.2 220398	11.0101-5407.2 260011 Hülsensatz 11.8116-0340.1 390595 Haltefeder 11.8171-0008.1 990049 Führungsbolzen
11.9347-7001.2 220473	11.0101-5407.2 260011 Hülsensatz 11.8170-0584.1 260105 Halter 11.8171-0008.1 990049 Führungsbolzen	11.9387-7003.2 220567	11.0101-5407.2 260011 Hülsensatz 11.8116-0340.1 390595 Haltefeder 11.8170-0633.1 260117 Halter 11.8171-0008.1 990049 Führungsbolzen
11.9347-7002.2 220474	11.0101-5407.2 260011 Hülsensatz 11.8170-0584.1 260105 Halter 11.8171-0008.1 990049 Führungsbolzen	11.9387-7004.2 220568	11.0101-5407.2 260011 Hülsensatz 11.8116-0340.1 390595 Haltefeder 11.8170-0633.1 260117 Halter 11.8171-0008.1 990049 Führungsbolzen
11.9347-7003.2 220565	11.0101-5407.2 260011 Hülsensatz 11.8116-0340.1 390595 Haltefeder 11.8170-0584.1 260105 Halter 11.8171-0008.1 990049 Führungsbolzen	11.9387-7005.2 220569	11.0101-5407.2 260011 Hülsensatz 11.8116-0340.1 390595 Haltefeder 11.8171-0008.1 990049 Führungsbolzen
11.9347-7004.2 220566	11.0101-5407.2 260011 Hülsensatz 11.8116-0340.1 390595 Haltefeder 11.8170-0584.1 260105 Halter 11.8171-0008.1 990049 Führungsbolzen	11.9387-7006.2 220570	11.0101-5407.2 260011 Hülsensatz 11.8116-0340.1 390595 Haltefeder 11.8171-0008.1 990049 Führungsbolzen
11.9347-7005.2 220643	11.0101-5407.2 260011 Hülsensatz 11.8116-0340.1 390595 Haltefeder 11.8171-0008.1 990049 Führungsbolzen	11.9387-7015.2 220627	11.0101-5407.2 260011 Hülsensatz 11.0230-0698.2 260091 Halter 11.8116-0340.1 390595 Haltefeder 11.8171-0008.1 990049 Führungsbolzen
11.9347-7006.2 220644	11.0101-5407.2 260011 Hülsensatz 11.8116-0340.1 390595 Haltefeder 11.8171-0008.1 990049 Führungsbolzen	11.9387-7016.2 220628	11.0101-5407.2 260011 Hülsensatz 11.0230-0698.2 260091 Halter 11.8116-0340.1 390595 Haltefeder 11.8171-0008.1 990049 Führungsbolzen
11.9367-7001.2 220733	11.0101-5407.2 260011 Hülsensatz 11.8116-0340.1 390595 Haltefeder 11.8171-0008.1 990049 Führungsbolzen	11.9387-7021.2 220629	11.0101-5407.2 260011 Hülsensatz 11.8116-0340.1 390595 Haltefeder 11.8171-0008.1 990049 Führungsbolzen
11.9367-7002.2 220734	11.0101-5407.2 260011 Hülsensatz 11.8116-0340.1 390595 Haltefeder 11.8171-0008.1 990049 Führungsbolzen	11.9387-7022.2 220630	11.0101-5407.2 260011 Hülsensatz 11.8116-0340.1 390595 Haltefeder 11.8171-0008.1 990049 Führungsbolzen
11.9381-9957.2 220661	11.0101-5407.2 260011 Hülsensatz 11.8116-0143.1 390513 Haltefeder 11.8171-0008.1 990049 Führungsbolzen	11.9387-7045.2 220797	11.0101-5407.2 260011 Hülsensatz 11.0230-0698.2 260091 Halter 11.8116-0340.1 390595 Haltefeder 11.8171-0008.1 990049 Führungsbolzen
11.9381-9958.2 220662	11.0101-5407.2 260011 Hülsensatz 11.8116-0143.1 390513 Haltefeder 11.8171-0008.1 990049 Führungsbolzen	11.9387-7046.2 220798	11.0101-5407.2 260011 Hülsensatz 11.0230-0698.2 260091 Halter 11.8116-0340.1 390595 Haltefeder 11.8171-0008.1 990049 Führungsbolzen
11.9381-9959.2 220433	11.0101-5402.2 260009 Hülsensatz 11.0441-3803.2 250010 Dichtungssatz 11.8116-0066.1 390577 Haltefeder 11.8171-0008.1 990049 Führungsbolzen		
11.9381-9960.2 220434	11.0101-5402.2 260009 Hülsensatz 11.0441-3803.2 250010 Dichtungssatz 11.8116-0066.1 390577 Haltefeder 11.8171-0008.1 990049 Führungsbolzen		

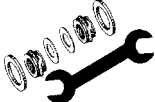

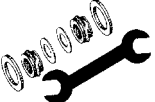



Reparatursätze

Repair kits - Corredi riparazione - Nécessaires de réparation - Juegos de reparación

	 		 
11.9401-9951.2 220463	11.0101-5402.2 260009 Hülsensatz 11.8116-0296.1 390445 Haltefeder 11.8171-0008.1 990049 Führungsbolzen	11.9407-7005.2 220637	11.0101-5407.2 260011 Hülsensatz 11.8116-0340.1 390595 Haltefeder 11.8170-0633.1 260117 Halter 11.8171-0008.1 990049 Führungsbolzen
11.9401-9952.2 220464	11.0101-5402.2 260009 Hülsensatz 11.8116-0296.1 390445 Haltefeder 11.8171-0008.1 990049 Führungsbolzen	11.9407-7006.2 220638	11.0101-5407.2 260011 Hülsensatz 11.8116-0340.1 390595 Haltefeder 11.8170-0633.1 260117 Halter 11.8171-0008.1 990049 Führungsbolzen
11.9401-9959.2 220833	11.0101-5402.2 260009 Hülsensatz 11.0441-4002.2 250011 Dichtungssatz 11.8171-0008.1 990049 Führungsbolzen	11.9421-9911.2 220825	11.0101-5402.2 260009 Hülsensatz 11.8116-0066.1 390577 Haltefeder 11.8171-0008.1 990049 Führungsbolzen
11.9401-9960.2 220834	11.0101-5402.2 260009 Hülsensatz 11.0441-4002.2 250011 Dichtungssatz 11.8171-0008.1 990049 Führungsbolzen	11.9421-9912.2 220826	11.0101-5402.2 260009 Hülsensatz 11.8116-0066.1 390577 Haltefeder 11.8171-0008.1 990049 Führungsbolzen
11.9401-9975.2 220495	11.0101-5402.2 260009 Hülsensatz 11.0441-4003.2 250001 Dichtungssatz 11.8116-0094.1 390504 Haltefeder 11.8171-0008.1 990049 Führungsbolzen	11.9421-9963.2 220465	11.0101-5402.2 260009 Hülsensatz 11.0230-0119.2 260089 Haltersatz 11.8116-0296.1 390445 Haltefeder 11.8171-0008.1 990049 Führungsbolzen
11.9401-9976.2 220496	11.0101-5402.2 260009 Hülsensatz 11.0441-4003.2 250001 Dichtungssatz 11.8116-0094.1 390504 Haltefeder 11.8171-0008.1 990049 Führungsbolzen	11.9421-9964.2 220466	11.0101-5402.2 260009 Hülsensatz 11.0230-0119.2 260089 Haltersatz 11.8116-0296.1 390445 Haltefeder 11.8171-0008.1 990049 Führungsbolzen
11.9401-9977.2 220439	11.0101-5402.2 260009 Hülsensatz 11.0441-4003.2 250001 Dichtungssatz 11.8116-0094.1 390504 Haltefeder 11.8171-0008.1 990049 Führungsbolzen	11.9421-9965.2 220799	11.0101-5407.2 260011 Hülsensatz 11.8116-0323.1 390459 Haltefeder 11.8171-0008.1 990049 Führungsbolzen
11.9401-9978.2 220440	11.0101-5402.2 260009 Hülsensatz 11.0441-4003.2 250001 Dichtungssatz 11.8116-0094.1 390504 Haltefeder 11.8171-0008.1 990049 Führungsbolzen	11.9421-9966.2 220800	11.0101-5407.2 260011 Hülsensatz 11.8116-0323.1 390459 Haltefeder 11.8171-0008.1 990049 Führungsbolzen
11.9406-9993.2 220413	11.0101-5402.2 260009 Hülsensatz 11.0441-4004.2 250012 Dichtungssatz 11.8116-0168.1 390499 Haltefeder 11.8171-0008.1 990049 Führungsbolzen	11.9421-9979.2 220497	11.0101-5407.2 260011 Hülsensatz 11.8116-0236.1 390507 Haltefeder 11.8171-0008.1 990049 Führungsbolzen
11.9406-9994.2 220414	11.0101-5402.2 260009 Hülsensatz 11.0441-4004.2 250012 Dichtungssatz 11.8116-0168.1 390499 Haltefeder 11.8171-0008.1 990049 Führungsbolzen	11.9421-9980.2 220498	11.0101-5407.2 260011 Hülsensatz 11.8116-0236.1 390507 Haltefeder 11.8171-0008.1 990049 Führungsbolzen
11.9406-9995.2 220415	11.0101-5402.2 260009 Hülsensatz 11.0441-4004.2 250012 Dichtungssatz 11.8116-0168.1 390499 Haltefeder 11.8171-0008.1 990049 Führungsbolzen	11.9426-9957.2 220895	11.0101-5402.2 260009 Hülsensatz 11.0441-4203.2 250013 Dichtungssatz 11.8116-0330.1 390472 Haltefeder 11.8171-0008.1 990049 Führungsbolzen
11.9406-9996.2 220416	11.0101-5402.2 260009 Hülsensatz 11.0441-4004.2 250012 Dichtungssatz 11.8116-0168.1 390499 Haltefeder 11.8171-0008.1 990049 Führungsbolzen	11.9426-9958.2 220896	11.0101-5402.2 260009 Hülsensatz 11.0441-4203.2 250013 Dichtungssatz 11.8116-0330.1 390472 Haltefeder 11.8171-0008.1 990049 Führungsbolzen
11.9407-7001.2 220573	11.0101-5407.2 260011 Hülsensatz 11.8116-0340.1 390595 Haltefeder 11.8170-0633.1 260117 Halter 11.8171-0008.1 990049 Führungsbolzen	11.9426-9959.2 220801	11.0101-5407.2 260011 Hülsensatz 11.8116-0323.1 390459 Haltefeder 11.8171-0008.1 990049 Führungsbolzen
11.9407-7002.2 220574	11.0101-5407.2 260011 Hülsensatz 11.8116-0340.1 390595 Haltefeder 11.8170-0633.1 260117 Halter 11.8171-0008.1 990049 Führungsbolzen	11.9426-9960.2 220802	11.0101-5407.2 260011 Hülsensatz 11.8116-0323.1 390459 Haltefeder 11.8171-0008.1 990049 Führungsbolzen
		11.9426-9977.2 220897	11.0101-5402.2 260009 Hülsensatz 11.0441-4203.2 250013 Dichtungssatz 11.8116-0330.1 390472 Haltefeder 11.8171-0008.1 990049 Führungsbolzen



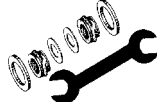

Reparatursätze

Repair kits - Corredi riparazione - Nécessaires de réparation - Juegos de reparación

  	  
<p>11.9426-9989.2 220639 11.0441-4203.2 250013 Dichtungssatz 11.8116-0323.1 390459 Haltefeder</p>	<p>11.9461-9984.2 220468 11.0101-5402.2 260009 Hülsensatz 11.0230-0176.2 260088 Haltersatz 11.0441-4203.2 250013 Dichtungssatz 11.8116-0296.1 390445 Haltefeder 11.8171-0008.1 990049 Führungsbolzen</p>
<p>11.9426-9990.2 220640 11.0441-4203.2 250013 Dichtungssatz 11.8116-0323.1 390459 Haltefeder</p>	<p>11.9481-9811.2 220445 11.0101-5407.2 260011 Hülsensatz 11.8116-0274.1 390516 Haltefeder 11.8171-0008.1 990049 Führungsbolzen</p>
<p>11.9426-9991.2 220641 11.0441-4203.2 250013 Dichtungssatz 11.8116-0323.1 390459 Haltefeder</p>	<p>11.9481-9812.2 220446 11.0101-5407.2 260011 Hülsensatz 11.8116-0274.1 390516 Haltefeder 11.8171-0008.1 990049 Führungsbolzen</p>
<p>11.9426-9992.2 220642 11.0441-4203.2 250013 Dichtungssatz 11.8116-0323.1 390459 Haltefeder</p>	<p>11.9481-9871.2 220681 11.0101-5407.2 260011 Hülsensatz 11.0441-4811.2 250024 Dichtungssatz 11.8116-0129.1 390591 Haltefeder 11.8171-0008.1 990049 Führungsbolzen</p>
<p>11.9426-9993.2 220443 11.0101-5402.2 260009 Hülsensatz 11.0441-4203.2 250013 Dichtungssatz 11.8116-0168.1 390499 Haltefeder 11.8171-0008.1 990049 Führungsbolzen</p>	<p>11.9481-9872.2 220682 11.0101-5407.2 260011 Hülsensatz 11.0441-4811.2 250024 Dichtungssatz 11.8116-0129.1 390591 Haltefeder 11.8171-0008.1 990049 Führungsbolzen</p>
<p>11.9426-9994.2 220444 11.0101-5402.2 260009 Hülsensatz 11.0441-4203.2 250013 Dichtungssatz 11.8116-0168.1 390499 Haltefeder 11.8171-0008.1 990049 Führungsbolzen</p>	<p>11.9521-7001.2 220499 11.0101-5407.2 260011 Hülsensatz 11.8171-0008.1 990049 Führungsbolzen</p>
<p>11.9441-9949.2 220803 11.0101-5409.2 260035 Hülsensatz 11.8116-0310.1 390611 Haltefeder 11.8171-0008.1 990049 Führungsbolzen</p>	<p>11.9521-7002.2 220500 11.0101-5407.2 260011 Hülsensatz 11.8171-0008.1 990049 Führungsbolzen</p>
<p>11.9441-9950.2 220804 11.0101-5409.2 260035 Hülsensatz 11.8116-0310.1 390611 Haltefeder 11.8171-0008.1 990049 Führungsbolzen</p>	<p>11.9541-9543.2 220645 11.0101-5407.2 260011 Hülsensatz 11.8116-0301.1 390610 Haltefeder 11.8171-0008.1 990049 Führungsbolzen</p>
<p>11.9441-9955.2 220805 11.8116-0133.1 390511 Haltefeder 11.8171-0096.1 250155 Führungsbolzen</p>	<p>11.9541-9544.2 220646 11.0101-5407.2 260011 Hülsensatz 11.8116-0301.1 390610 Haltefeder 11.8171-0008.1 990049 Führungsbolzen</p>
<p>11.9441-9956.2 220806 11.8116-0133.1 390511 Haltefeder 11.8171-0096.1 250155 Führungsbolzen</p>	<p>11.9541-9545.2 220625 11.0101-5407.2 260011 Hülsensatz 11.8116-0301.1 390610 Haltefeder 11.8171-0008.1 990049 Führungsbolzen</p>
<p>11.9441-9957.2 220827 11.0101-5402.2 260009 Hülsensatz 11.8116-0296.1 390445 Haltefeder 11.8171-0008.1 990049 Führungsbolzen</p>	<p>11.9541-9546.2 220626 11.0101-5407.2 260011 Hülsensatz 11.8116-0301.1 390610 Haltefeder 11.8171-0008.1 990049 Führungsbolzen</p>
<p>11.9441-9958.2 220828 11.0101-5402.2 260009 Hülsensatz 11.8116-0296.1 390445 Haltefeder 11.8171-0008.1 990049 Führungsbolzen</p>	<p>11.9541-9549.2 220575 11.0101-5409.2 260035 Hülsensatz 11.0441-5409.2 250031 Dichtungssatz 11.8171-0069.1 250152 Führungsbolzen</p>
<p>11.9441-9967.2 220807 11.0101-5409.2 260035 Hülsensatz 11.8116-0310.1 390611 Haltefeder 11.8171-0008.1 990049 Führungsbolzen</p>	<p>11.9541-9550.2 220576 11.0101-5409.2 260035 Hülsensatz 11.0441-5409.2 250031 Dichtungssatz 11.8171-0069.1 250152 Führungsbolzen</p>
<p>11.9441-9968.2 220808 11.0101-5409.2 260035 Hülsensatz 11.8116-0310.1 390611 Haltefeder 11.8171-0008.1 990049 Führungsbolzen</p>	<p>11.9541-9553.2 220563 11.0101-5409.2 260035 Hülsensatz 11.8116-0351.1 390538 Haltefeder 11.8171-0008.1 990049 Führungsbolzen</p>
<p>11.9441-9971.2 220839 11.0101-7003.2 260124 Hülsensatz</p>	<p>11.9541-9554.2 220564 11.0101-5409.2 260035 Hülsensatz 11.8116-0351.1 390538 Haltefeder 11.8171-0008.1 990049 Führungsbolzen</p>
<p>11.9441-9972.2 220840 11.0101-7003.2 260124 Hülsensatz</p>	<p>11.9541-9569.2 220725 11.0101-5407.2 260011 Hülsensatz 11.8116-0264.1 390594 Haltefeder 11.8171-0008.1 990049 Führungsbolzen</p>
<p>11.9461-9981.2 220899 11.0101-5402.2 260009 Hülsensatz 11.8116-0296.1 390445 Haltefeder 11.8171-0008.1 990049 Führungsbolzen</p>	<p>11.9541-9570.2 220726 11.0101-5407.2 260011 Hülsensatz 11.8116-0264.1 390594 Haltefeder 11.8171-0008.1 990049 Führungsbolzen</p>
<p>11.9461-9982.2 220900 11.0101-5402.2 260009 Hülsensatz 11.8116-0296.1 390445 Haltefeder 11.8171-0008.1 990049 Führungsbolzen</p>	<p>11.9461-9983.2 220467 11.0101-5402.2 260009 Hülsensatz 11.0230-0176.2 260088 Haltersatz 11.0441-4203.2 250013 Dichtungssatz 11.8116-0296.1 390445 Haltefeder 11.8171-0008.1 990049 Führungsbolzen</p>

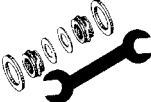

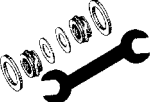

Reparatursätze

Repair kits - Corredi riparazione - Nécessaires de réparation - Juegos de reparación

	 		 
11.9541-9575.2 220829	11.0101-5402.2 260009 Hülsensatz 11.8116-0206.1 390593 Haltefeder 11.8171-0008.1 990049 Führungsbolzen	11.9571-9765.2 220663	11.0101-5704.2 260095 Hülsensatz 11.8116-0351.1 390538 Haltefeder 11.8171-0008.1 990049 Führungsbolzen
11.9541-9576.2 220830	11.0101-5402.2 260009 Hülsensatz 11.8116-0206.1 390593 Haltefeder 11.8171-0008.1 990049 Führungsbolzen	11.9571-9766.2 220664	11.0101-5704.2 260095 Hülsensatz 11.8116-0351.1 390538 Haltefeder 11.8171-0008.1 990049 Führungsbolzen
11.9541-9587.2 220419	11.0101-5402.2 260009 Hülsensatz 11.0441-5402.2 250028 Dichtungssatz 11.8116-0109.1 390495 Haltefeder 11.8116-0206.1 390593 Haltefeder 11.8170-0729.1 260107 Halter 11.8170-0730.1 260108 Halter 11.8171-0008.1 990049 Führungsbolzen	11.9571-9779.2 220657	11.0101-5407.2 260011 Hülsensatz 11.8116-0356.1 390586 Haltefeder 11.8171-0008.1 990049 Führungsbolzen
11.9541-9588.2 220420	11.0101-5402.2 260009 Hülsensatz 11.0441-5402.2 250028 Dichtungssatz 11.8116-0109.1 390495 Haltefeder 11.8116-0206.1 390593 Haltefeder 11.8170-0729.1 260107 Halter 11.8170-0730.1 260108 Halter 11.8171-0008.1 990049 Führungsbolzen	11.9571-9780.2 220658	11.0101-5407.2 260011 Hülsensatz 11.8116-0356.1 390586 Haltefeder 11.8171-0008.1 990049 Führungsbolzen
11.9541-9595.2 220501	11.0101-5409.2 260035 Hülsensatz 11.0441-5409.2 250031 Dichtungssatz 11.8116-0143.1 390513 Haltefeder 11.8171-0008.1 990049 Führungsbolzen	11.9571-9781.2 220659	11.0101-5407.2 260011 Hülsensatz 11.8116-0295.2 390524 Haltefeder 11.8116-0356.1 390586 Haltefeder 11.8171-0008.1 990049 Führungsbolzen
11.9541-9596.2 220502	11.0101-5409.2 260035 Hülsensatz 11.0441-5409.2 250031 Dichtungssatz 11.8116-0143.1 390513 Haltefeder 11.8171-0008.1 990049 Führungsbolzen	11.9571-9782.2 220660	11.0101-5407.2 260011 Hülsensatz 11.8116-0295.2 390524 Haltefeder 11.8116-0356.1 390586 Haltefeder 11.8171-0008.1 990049 Führungsbolzen
11.9541-9667.2 220421	11.0101-5402.2 260009 Hülsensatz 11.0230-0444.1 260104 Halter 11.0441-5402.2 250028 Dichtungssatz 11.8116-0109.1 390495 Haltefeder 11.8116-0206.1 390593 Haltefeder 11.8171-0008.1 990049 Führungsbolzen	11.9571-9785.2 220595	11.0101-5407.2 260011 Hülsensatz 11.8116-0356.1 390586 Haltefeder 11.8171-0008.1 990049 Führungsbolzen
11.9541-9668.2 220422	11.0101-5402.2 260009 Hülsensatz 11.0230-0444.1 260104 Halter 11.0441-5402.2 250028 Dichtungssatz 11.8116-0109.1 390495 Haltefeder 11.8116-0206.1 390593 Haltefeder 11.8171-0008.1 990049 Führungsbolzen	11.9571-9786.2 220596	11.0101-5407.2 260011 Hülsensatz 11.8116-0356.1 390586 Haltefeder 11.8171-0008.1 990049 Führungsbolzen
11.9541-9805.2 220503	11.0101-5407.2 260011 Hülsensatz 11.8116-0073.1 390498 Haltefeder 11.8171-0008.1 990049 Führungsbolzen	11.9571-9793.2 220665	11.8116-0351.1 390538 Haltefeder
11.9541-9806.2 220504	11.0101-5407.2 260011 Hülsensatz 11.8116-0073.1 390498 Haltefeder 11.8171-0008.1 990049 Führungsbolzen	11.9571-9794.2 220666	11.8116-0351.1 390538 Haltefeder
11.9541-9950.2 220843	11.8170-0002.1 260110 Halter	11.9571-9801.2 220577	11.0101-5407.2 260011 Hülsensatz 11.8116-0279.1 390519 Haltefeder 11.8171-0008.1 990049 Führungsbolzen
11.9541-9951.2 220844	11.8170-0002.1 260110 Halter	11.9571-9802.2 220578	11.0101-5407.2 260011 Hülsensatz 11.8116-0279.1 390519 Haltefeder 11.8171-0008.1 990049 Führungsbolzen
11.9546-9997.2 220399	11.0101-5407.2 260011 Hülsensatz	11.9571-9811.2 220485	11.0101-5407.2 260011 Hülsensatz 11.0101-5706.2 260097 Hülsensatz 11.0441-5704.2 250034 Dichtungssatz 11.8116-0326.1 390471 Haltefeder 11.8171-0008.1 990049 Führungsbolzen 11.8171-0067.1 250153 Führungsbolzen
11.9546-9998.2 220400	11.0101-5407.2 260011 Hülsensatz	11.9571-9812.2 220486	11.0101-5407.2 260011 Hülsensatz 11.0101-5706.2 260097 Hülsensatz 11.0441-5704.2 250034 Dichtungssatz 11.8116-0326.1 390471 Haltefeder 11.8171-0008.1 990049 Führungsbolzen 11.8171-0067.1 250153 Führungsbolzen
11.9571-9757.2 220857	11.8116-0301.1 390610 Haltefeder	11.9571-9813.2 220647	11.0101-5407.2 260011 Hülsensatz 11.8116-0356.1 390586 Haltefeder 11.8171-0008.1 990049 Führungsbolzen
11.9571-9758.2 220858	11.8116-0301.1 390610 Haltefeder	11.9571-9814.2 220648	11.0101-5407.2 260011 Hülsensatz 11.8116-0356.1 390586 Haltefeder 11.8171-0008.1 990049 Führungsbolzen

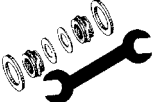

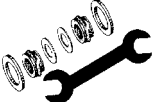

Reparatursätze

Repair kits - Corredi riparazione - Nécessaires de réparation - Juegos de reparación

	 		 
11.9571-9819.2 220469	11.0101-5705.2 260096 Hülsensatz 11.0441-5704.2 250034 Dichtungssatz 11.8116-0326.1 390471 Haltefeder 11.8171-0067.1 250153 Führungsbolzen	11.9571-9863.2 220513	11.0101-5407.2 260011 Hülsensatz 11.8116-0366.2 390587 Haltefeder 11.8171-0008.1 990049 Führungsbolzen 11.8171-0067.1 250153 Führungsbolzen
11.9571-9820.2 220470	11.0101-5705.2 260096 Hülsensatz 11.0441-5704.2 250034 Dichtungssatz 11.8116-0326.1 390471 Haltefeder 11.8171-0067.1 250153 Führungsbolzen	11.9571-9864.2 220514	11.0101-5407.2 260011 Hülsensatz 11.8116-0366.2 390587 Haltefeder 11.8171-0008.1 990049 Führungsbolzen 11.8171-0067.1 250153 Führungsbolzen
11.9571-9821.2 220579	11.0101-5407.2 260011 Hülsensatz 11.8116-0279.1 390519 Haltefeder 11.8171-0008.1 990049 Führungsbolzen	11.9571-9867.2 220423	11.0101-5704.2 260095 Hülsensatz 11.0441-5704.2 250034 Dichtungssatz 11.8171-0008.1 990049 Führungsbolzen
11.9571-9822.2 220580	11.0101-5407.2 260011 Hülsensatz 11.8116-0279.1 390519 Haltefeder 11.8171-0008.1 990049 Führungsbolzen	11.9571-9868.2 220424	11.0101-5704.2 260095 Hülsensatz 11.0441-5704.2 250034 Dichtungssatz 11.8171-0008.1 990049 Führungsbolzen
11.9571-9823.2 220471	11.0101-5407.2 260011 Hülsensatz 11.0441-5704.2 250034 Dichtungssatz 11.8116-0292.1 390521 Haltefeder 11.8171-0008.1 990049 Führungsbolzen	11.9571-9871.2 220425	11.0101-5407.2 260011 Hülsensatz 11.8171-0008.1 990049 Führungsbolzen
11.9571-9824.2 220472	11.0101-5407.2 260011 Hülsensatz 11.0441-5704.2 250034 Dichtungssatz 11.8116-0292.1 390521 Haltefeder 11.8171-0008.1 990049 Führungsbolzen	11.9571-9872.2 220426	11.0101-5407.2 260011 Hülsensatz 11.8171-0008.1 990049 Führungsbolzen
11.9571-9835.2 220427	11.0101-5409.2 260035 Hülsensatz 11.0441-5704.2 250034 Dichtungssatz 11.8116-0143.1 390513 Haltefeder 11.8116-0347.2 390535 Haltefeder 11.8171-0008.1 990049 Führungsbolzen	11.9571-9971.2 220605	11.0101-5407.2 260011 Hülsensatz 11.0441-5702.2 250033 Dichtungssatz 11.8116-0073.1 390498 Haltefeder 11.8171-0008.1 990049 Führungsbolzen
11.9571-9836.2 220428	11.0101-5409.2 260035 Hülsensatz 11.0441-5704.2 250034 Dichtungssatz 11.8116-0143.1 390513 Haltefeder 11.8116-0347.2 390535 Haltefeder 11.8171-0008.1 990049 Führungsbolzen	11.9571-9972.2 220606	11.0101-5407.2 260011 Hülsensatz 11.0441-5702.2 250033 Dichtungssatz 11.8116-0073.1 390498 Haltefeder 11.8171-0008.1 990049 Führungsbolzen
11.9571-9841.2 220401	11.0101-5407.2 260011 Hülsensatz 11.8116-0301.1 390610 Haltefeder 11.8171-0008.1 990049 Führungsbolzen	11.9576-9947.2 220809	11.0101-5409.2 260035 Hülsensatz 11.8116-0410.2 390589 Haltefeder 11.8171-0008.1 990049 Führungsbolzen
11.9571-9842.2 220402	11.0101-5407.2 260011 Hülsensatz 11.8116-0301.1 390610 Haltefeder 11.8171-0008.1 990049 Führungsbolzen	11.9576-9948.2 220810	11.0101-5409.2 260035 Hülsensatz 11.8116-0410.2 390589 Haltefeder 11.8171-0008.1 990049 Führungsbolzen
11.9571-9847.2 220487	11.0101-5407.2 260011 Hülsensatz 11.0101-5409.2 260035 Hülsensatz 11.0441-5704.2 250034 Dichtungssatz 11.8116-0143.1 390513 Haltefeder 11.8171-0008.1 990049 Führungsbolzen	11.9576-9975.2 220649	11.0101-5407.2 260011 Hülsensatz 11.8116-0345.2 390596 Haltefeder 11.8116-0410.2 390589 Haltefeder 11.8171-0008.1 990049 Führungsbolzen
11.9571-9848.2 220488	11.0101-5407.2 260011 Hülsensatz 11.0101-5409.2 260035 Hülsensatz 11.0441-5704.2 250034 Dichtungssatz 11.8116-0143.1 390513 Haltefeder 11.8171-0008.1 990049 Führungsbolzen	11.9576-9976.2 220650	11.0101-5407.2 260011 Hülsensatz 11.8116-0345.2 390596 Haltefeder 11.8116-0410.2 390589 Haltefeder 11.8171-0008.1 990049 Führungsbolzen
11.9571-9861.2 220403	11.0101-5407.2 260011 Hülsensatz 11.8116-0301.1 390610 Haltefeder 11.8171-0008.1 990049 Führungsbolzen	11.9576-9995.2 220651	11.0101-5409.2 260035 Hülsensatz 11.8116-0410.2 390589 Haltefeder 11.8171-0008.1 990049 Führungsbolzen
11.9571-9862.2 220404	11.0101-5407.2 260011 Hülsensatz 11.8116-0301.1 390610 Haltefeder 11.8171-0008.1 990049 Führungsbolzen	11.9576-9996.2 220652	11.0101-5409.2 260035 Hülsensatz 11.8116-0410.2 390589 Haltefeder 11.8171-0008.1 990049 Führungsbolzen
		11.9601-2601.2 220913	11.0103-0002.2 250157 Bremssattel-Zubehör
		11.9601-2602.2 220914	11.0103-0002.2 250157 Bremssattel-Zubehör
		11.9601-2603.2 220915	11.0103-0002.2 250157 Bremssattel-Zubehör
		11.9601-2604.2 220916	11.0103-0002.2 250157 Bremssattel-Zubehör

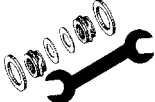

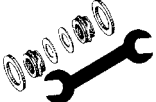

Reparatursätze

Repair kits - Corredi riparazione - Nécessaires de réparation - Juegos de reparación

	 		 
11.9601-8501.2 220593	11.0101-5706.2 260097 Hülsensatz 11.0441-6008.2 250038 Dichtungssatz 11.8116-0237.1 390509 Haltefeder 11.8171-0067.1 250153 Führungsbolzen	11.9601-9824.2 220850	11.0101-5402.2 260009 Hülsensatz 11.0441-6003.2 250037 Dichtungssatz
11.9601-8502.2 220594	11.0101-5706.2 260097 Hülsensatz 11.0441-6008.2 250038 Dichtungssatz 11.8116-0237.1 390509 Haltefeder 11.8171-0067.1 250153 Führungsbolzen	11.9601-9829.2 220505	11.0101-5407.2 260011 Hülsensatz 11.8116-0366.2 390587 Haltefeder 11.8171-0008.1 990049 Führungsbolzen 11.8171-0067.1 250153 Führungsbolzen
11.9601-9717.2 220901	11.0441-6008.2 250038 Dichtungssatz	11.9601-9830.2 220506	11.0101-5407.2 260011 Hülsensatz 11.8116-0366.2 390587 Haltefeder 11.8171-0008.1 990049 Führungsbolzen 11.8171-0067.1 250153 Führungsbolzen
11.9601-9718.2 220902	11.0441-6008.2 250038 Dichtungssatz	11.9601-9883.2 220917	11.0441-6008.2 250038 Dichtungssatz
11.9601-9721.2 220875	11.8116-0367.1 390600 Haltefeder	11.9601-9884.2 220918	11.0441-6008.2 250038 Dichtungssatz
11.9601-9722.2 220876	11.8116-0367.1 390600 Haltefeder	11.9606-9945.2 220727	11.0101-5704.2 260095 Hülsensatz 11.8116-0388.2 390588 Haltefeder 11.8171-0008.1 990049 Führungsbolzen
11.9601-9731.2 220853	11.0441-6008.2 250038 Dichtungssatz	11.9606-9946.2 220728	11.0101-5704.2 260095 Hülsensatz 11.8116-0388.2 390588 Haltefeder 11.8171-0008.1 990049 Führungsbolzen
11.9601-9732.2 220854	11.0441-6008.2 250038 Dichtungssatz	11.9606-9953.2 220587	11.0101-5409.2 260035 Hülsensatz 11.0441-6008.2 250038 Dichtungssatz 11.8116-0347.2 390535 Haltefeder 11.8116-0410.2 390589 Haltefeder 11.8171-0008.1 990049 Führungsbolzen
11.9601-9745.2 220653	11.0101-5407.2 260011 Hülsensatz 11.8116-0206.1 390593 Haltefeder 11.8171-0008.1 990049 Führungsbolzen	11.9606-9954.2 220588	11.0101-5409.2 260035 Hülsensatz 11.0441-6008.2 250038 Dichtungssatz 11.8116-0347.2 390535 Haltefeder 11.8116-0410.2 390589 Haltefeder 11.8171-0008.1 990049 Führungsbolzen
11.9601-9746.2 220654	11.0101-5407.2 260011 Hülsensatz 11.8116-0206.1 390593 Haltefeder 11.8171-0008.1 990049 Führungsbolzen	11.9606-9957.2 220815	11.0101-5409.2 260035 Hülsensatz 11.0441-6008.2 250038 Dichtungssatz 11.8116-0410.2 390589 Haltefeder 11.8171-0008.1 990049 Führungsbolzen
11.9601-9759.2 220811	11.0101-5704.2 260095 Hülsensatz 11.8116-0356.1 390586 Haltefeder 11.8171-0008.1 990049 Führungsbolzen	11.9606-9958.2 220816	11.0101-5409.2 260035 Hülsensatz 11.0441-6008.2 250038 Dichtungssatz 11.8116-0410.2 390589 Haltefeder 11.8171-0008.1 990049 Führungsbolzen
11.9601-9760.2 220812	11.0101-5704.2 260095 Hülsensatz 11.8116-0356.1 390586 Haltefeder 11.8171-0008.1 990049 Führungsbolzen	11.9606-9959.2 220729	11.0101-6006.2 260098 Hülsensatz 11.8116-0366.2 390587 Haltefeder 11.8171-0008.1 990049 Führungsbolzen 11.8171-0067.1 250153 Führungsbolzen
11.9601-9765.2 220813	11.0101-5407.2 260011 Hülsensatz 11.8116-0237.1 390509 Haltefeder 11.8171-0008.1 990049 Führungsbolzen	11.9606-9960.2 220730	11.0101-6006.2 260098 Hülsensatz 11.8116-0366.2 390587 Haltefeder 11.8171-0008.1 990049 Führungsbolzen 11.8171-0067.1 250153 Führungsbolzen
11.9601-9766.2 220814	11.0101-5407.2 260011 Hülsensatz 11.8116-0237.1 390509 Haltefeder 11.8171-0008.1 990049 Führungsbolzen	11.9606-9961.2 220655	11.0101-5409.2 260035 Hülsensatz 11.0441-6008.2 250038 Dichtungssatz 11.8116-0410.2 390589 Haltefeder 11.8171-0008.1 990049 Führungsbolzen
11.9601-9771.2 220583	11.0101-5706.2 260097 Hülsensatz 11.0441-6008.2 250038 Dichtungssatz 11.8116-0237.1 390509 Haltefeder 11.8171-0067.1 250153 Führungsbolzen	11.9606-9962.2 220656	11.0101-5409.2 260035 Hülsensatz 11.0441-6008.2 250038 Dichtungssatz 11.8116-0410.2 390589 Haltefeder 11.8171-0008.1 990049 Führungsbolzen
11.9601-9772.2 220584	11.0101-5706.2 260097 Hülsensatz 11.0441-6008.2 250038 Dichtungssatz 11.8116-0237.1 390509 Haltefeder 11.8171-0067.1 250153 Führungsbolzen		
11.9601-9787.2 220585	11.0101-5407.2 260011 Hülsensatz 11.0441-6008.2 250038 Dichtungssatz 11.8116-0301.1 390610 Haltefeder 11.8171-0008.1 990049 Führungsbolzen		
11.9601-9788.2 220586	11.0101-5407.2 260011 Hülsensatz 11.0441-6008.2 250038 Dichtungssatz 11.8116-0301.1 390610 Haltefeder 11.8171-0008.1 990049 Führungsbolzen		
11.9601-9823.2 220849	11.0101-5402.2 260009 Hülsensatz 11.0441-6003.2 250037 Dichtungssatz		







Reparatursätze

Repair kits - Corredi riparazione - Nécessaires de réparation - Juegos de reparación

					
11.9606-9965.2 220817	11.0101-5409.2 260035 Hülsensatz 11.0101-5704.2 260095 Hülsensatz 11.0441-6008.2 250038 Dichtungssatz 11.8116-0299.1 390446 Haltefeder 11.8116-0327.1 390599 Haltefeder 11.8171-0008.1 990049 Führungsbolzen		11.9606-9992.2 220430	11.0101-5402.2 260009 Hülsensatz 11.0441-6008.2 250038 Dichtungssatz 11.8116-0239.2 390510 Haltefeder 11.8171-0008.1 990049 Führungsbolzen	
11.9606-9966.2 220818	11.0101-5409.2 260035 Hülsensatz 11.0101-5704.2 260095 Hülsensatz 11.0441-6008.2 250038 Dichtungssatz 11.8116-0299.1 390446 Haltefeder 11.8116-0327.1 390599 Haltefeder 11.8171-0008.1 990049 Führungsbolzen		13.2351-0011.2 210008	13.0441-3506.2 250052 Dichtungssatz	
11.9606-9967.2 220905	11.0101-5402.2 260009 Hülsensatz 11.0441-6008.2 250038 Dichtungssatz 11.8116-0339.2 390528 Haltefeder 11.8171-0008.1 990049 Führungsbolzen		13.2351-0012.2 210009	13.0441-3506.2 250052 Dichtungssatz	
11.9606-9968.2 220906	11.0101-5402.2 260009 Hülsensatz 11.0441-6008.2 250038 Dichtungssatz 11.8116-0339.2 390528 Haltefeder 11.8171-0008.1 990049 Führungsbolzen		13.2351-0013.2 210010	13.0441-3506.2 250052 Dichtungssatz	
11.9606-9969.2 220731	11.0101-6006.2 260098 Hülsensatz 11.8116-0366.2 390587 Haltefeder 11.8171-0008.1 990049 Führungsbolzen 11.8171-0067.1 250153 Führungsbolzen		13.2351-0014.2 210011	13.0441-3506.2 250052 Dichtungssatz	
11.9606-9970.2 220732	11.0101-6006.2 260098 Hülsensatz 11.8116-0366.2 390587 Haltefeder 11.8171-0008.1 990049 Führungsbolzen 11.8171-0067.1 250153 Führungsbolzen		13.2351-0017.2 210012	13.0441-3506.2 250052 Dichtungssatz	
11.9606-9971.2 220589	11.0101-5407.2 260011 Hülsensatz 11.0441-6008.2 250038 Dichtungssatz 11.8116-0345.2 390596 Haltefeder 11.8171-0008.1 990049 Führungsbolzen		13.2351-0018.2 210013	13.0441-3506.2 250052 Dichtungssatz	
11.9606-9972.2 220590	11.0101-5407.2 260011 Hülsensatz 11.0441-6008.2 250038 Dichtungssatz 11.8116-0345.2 390596 Haltefeder 11.8171-0008.1 990049 Führungsbolzen		13.2351-0025.2 210210	13.0441-3506.2 250052 Dichtungssatz	
11.9606-9979.2 220907	11.0101-6006.2 260098 Hülsensatz 11.0441-6008.2 250038 Dichtungssatz 11.8116-0315.2 390447 Haltefeder 11.8171-0008.1 990049 Führungsbolzen 11.8171-0067.1 250153 Führungsbolzen		13.2351-0026.2 210211	13.0441-3506.2 250052 Dichtungssatz	
11.9606-9980.2 220908	11.0101-6006.2 260098 Hülsensatz 11.0441-6008.2 250038 Dichtungssatz 11.8116-0315.2 390447 Haltefeder 11.8171-0008.1 990049 Führungsbolzen 11.8171-0067.1 250153 Führungsbolzen		13.2351-0051.2 210180	13.0441-3507.2 250053 Dichtungssatz	
11.9606-9981.2 220591	11.0101-5407.2 260011 Hülsensatz 11.8116-0325.2 390461 Haltefeder 11.8171-0008.1 990049 Führungsbolzen		13.2351-0052.2 210181	13.0441-3507.2 250053 Dichtungssatz	
11.9606-9982.2 220592	11.0101-5407.2 260011 Hülsensatz 11.8116-0325.2 390461 Haltefeder 11.8171-0008.1 990049 Führungsbolzen		13.2351-8005.2 210014	13.0441-3505.2 250051 Dichtungssatz	
11.9606-9991.2 220429	11.0101-5402.2 260009 Hülsensatz 11.0441-6008.2 250038 Dichtungssatz 11.8116-0239.2 390510 Haltefeder 11.8171-0008.1 990049 Führungsbolzen		13.2351-8006.2 210015	13.0441-3505.2 250051 Dichtungssatz	
			13.2351-8019.2 210139	13.0441-3507.2 250053 Dichtungssatz	
			13.2351-8020.2 210140	13.0441-3507.2 250053 Dichtungssatz	
			13.2353-8003.2 210016	13.0441-3504.2 250050 Dichtungssatz	
			13.2353-8004.2 210017	13.0441-3504.2 250050 Dichtungssatz	
			13.2361-8001.2 210214	13.0441-3606.2 250147 Dichtungssatz	
			13.2361-8002.2 210215	13.0441-3606.2 250147 Dichtungssatz	
			13.2361-8003.2 210220	13.0441-3609.2 250057 Dichtungssatz	
			13.2361-8004.2 210221	13.0441-3609.2 250057 Dichtungssatz	
			13.2361-8005.2 210237	13.0441-3609.2 250057 Dichtungssatz	
			13.2361-8006.2 210238	13.0441-3609.2 250057 Dichtungssatz	
			13.2381-0039.2 210020	13.0441-3812.2 250068 Dichtungssatz	
			13.2381-0040.2 210021	13.0441-3812.2 250068 Dichtungssatz	
			13.2381-0067.2 210024	13.0441-3815.2 250069 Dichtungssatz	
			13.2381-0068.2 210025	13.0441-3815.2 250069 Dichtungssatz	
			13.2381-0083.2 210026	13.0441-3819.2 250072 Dichtungssatz	
			13.2381-0084.2 210027	13.0441-3819.2 250072 Dichtungssatz	
			13.2381-0085.2 210028	13.0441-3819.2 250072 Dichtungssatz	
			13.2381-0086.2 210029	13.0441-3819.2 250072 Dichtungssatz	
			13.2381-0087.2 210149	13.0441-3819.2 250072 Dichtungssatz	
			13.2381-0088.2 210150	13.0441-3819.2 250072 Dichtungssatz	



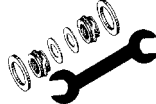



Reparatursätze

Repair kits - Corredi riparazione - Nécessaires de réparation - Juegos de reparación

							
13.2381-8027.2210033	13.0441-3811.2	250067	Dichtungssatz	13.2421-8025.2210061	13.0441-4216.2	250093	Dichtungssatz
13.2381-8028.2210034	13.0441-3811.2	250067	Dichtungssatz	13.2421-8026.2210062	13.0441-4216.2	250093	Dichtungssatz
13.2381-8029.2210035	13.0441-3811.2	250067	Dichtungssatz	13.2423-8009.2210063	13.0441-4206.2	250087	Dichtungssatz
13.2381-8030.2210036	13.0441-3811.2	250067	Dichtungssatz	13.2423-8010.2210064	13.0441-4206.2	250087	Dichtungssatz
13.2381-8033.2210222	13.0441-3817.2	250071	Dichtungssatz	13.2424-0009.2210065	13.0441-4212.2	250089	Dichtungssatz
13.2381-8034.2210223	13.0441-3817.2	250071	Dichtungssatz	13.2424-0010.2210066	13.0441-4212.2	250089	Dichtungssatz
13.2381-8035.2210037	13.0441-3817.2	250071	Dichtungssatz	13.2424-8001.2210072	13.0441-4212.2	250089	Dichtungssatz
13.2381-8036.2210038	13.0441-3817.2	250071	Dichtungssatz	13.2424-8002.2210073	13.0441-4212.2	250089	Dichtungssatz
13.2381-9996.2210039	13.0441-3801.2	250058	Dichtungssatz	13.2461-8001.2210226	13.0441-4601.2	250099	Dichtungssatz
13.2381-9997.2210040	13.0441-3801.2	250058	Dichtungssatz	13.2461-8002.2210227	13.0441-4601.2	250099	Dichtungssatz
13.2383-0001.2210041	13.0441-3803.2	250060	Dichtungssatz	13.2481-0024.2210074	13.0441-4819.2	250104	Dichtungssatz
13.2383-0002.2210042	13.0441-3803.2	250060	Dichtungssatz	13.2481-0026.2210075	13.0441-4825.2	250107	Dichtungssatz
13.2384-0013.2210043	13.0441-3810.2	250066	Dichtungssatz	13.2481-0033.2210076	13.0441-4819.2	250104	Dichtungssatz
13.2384-0014.2210044	13.0441-3810.2	250066	Dichtungssatz	13.2481-0034.2210077	13.0441-4819.2	250104	Dichtungssatz
13.2401-0025.2210224	13.0441-4022.2	250149	Dichtungssatz	13.2481-0057.2210078	13.0441-4819.2	250104	Dichtungssatz
13.2401-0026.2210225	13.0441-4022.2	250149	Dichtungssatz	13.2481-0073.2210079	13.0441-4819.2	250104	Dichtungssatz
13.2401-0027.2210045	13.0441-4014.2	250079	Dichtungssatz	13.2481-0074.2210080	13.0441-4819.2	250104	Dichtungssatz
13.2401-0028.2210046	13.0441-4014.2	250079	Dichtungssatz	13.2481-0075.2210081	13.0441-4819.2	250104	Dichtungssatz
13.2401-0039.2210153	13.0441-4022.2	250149	Dichtungssatz	13.2481-0076.2210082	13.0441-4819.2	250104	Dichtungssatz
13.2401-0040.2210154	13.0441-4022.2	250149	Dichtungssatz	13.2481-2311.3 210085	13.0441-4819.2	250104	Dichtungssatz
13.2401-8007.2210047	13.0441-4002.2	250074	Dichtungssatz	13.2481-2411.3 210086	13.0441-4819.2	250104	Dichtungssatz
	13.0441-4008.2	250076	Dichtungssatz	13.2481-7404.3 210089	13.0441-4819.2	250104	Dichtungssatz
13.2401-8008.2210048	13.0441-4002.2	250074	Dichtungssatz	13.2481-8007.2210090	13.0441-4825.2	250107	Dichtungssatz
	13.0441-4008.2	250076	Dichtungssatz	13.2481-8008.2210091	13.0441-4825.2	250107	Dichtungssatz
13.2401-8013.2210051	13.0441-4020.2	250084	Dichtungssatz	13.2481-8011.2 210092	13.0441-4825.2	250107	Dichtungssatz
13.2401-8014.2210052	13.0441-4020.2	250084	Dichtungssatz	13.2481-8012.2210093	13.0441-4825.2	250107	Dichtungssatz
13.2421-0025.2210145	13.0441-4206.2	250087	Dichtungssatz	13.2481-8013.2210094	13.0441-4825.2	250107	Dichtungssatz
13.2421-0026.2210146	13.0441-4206.2	250087	Dichtungssatz	13.2481-8014.2210095	13.0441-4825.2	250107	Dichtungssatz
13.2421-0043.2210193	13.0441-4216.2	250093	Dichtungssatz	13.2481-8057.2210096	13.0441-4825.2	250107	Dichtungssatz
13.2421-0044.2210194	13.0441-4216.2	250093	Dichtungssatz	13.2481-8058.2210097	13.0441-4825.2	250107	Dichtungssatz
13.2421-8005.2210053	13.0441-4205.2	250086	Dichtungssatz	13.2481-8067.2210098	13.0441-4819.2	250104	Dichtungssatz
13.2421-8006.2210054	13.0441-4205.2	250086	Dichtungssatz	13.2481-8068.2210099	13.0441-4819.2	250104	Dichtungssatz
13.2421-8007.2210055	13.0441-4205.2	250086	Dichtungssatz	13.2481-9992.2210100	13.0441-4819.2	250104	Dichtungssatz
13.2421-8008.2210056	13.0441-4205.2	250086	Dichtungssatz	13.2481-9993.2210101	13.0441-4819.2	250104	Dichtungssatz
13.2421-8021.2210057	13.0441-4206.2	250087	Dichtungssatz	13.2481-9998.2210102	13.0441-4815.2	250102	Dichtungssatz
13.2421-8022.2210058	13.0441-4206.2	250087	Dichtungssatz				







Reparatursätze

Repair kits - Corredi riparazione - Nécessaires de réparation - Juegos de reparación

					
13.2481-9999.2210103	13.0441-4815.2 250102	Dichtungssatz	13.2601-7016.2210231	03.3518-6100.2 390364 Entlüfterventil 03.3518-8000.2 390373 Entlüfterventil 13.0441-6012.2 250133 Dichtungssatz	
13.2483-8001.2210104	13.0441-4825.2 250107	Dichtungssatz	13.2601-8025.2210157	13.0441-6001.2 250126 Dichtungssatz	
13.2483-8002.2210105	13.0441-4825.2 250107	Dichtungssatz	13.2601-8026.2210158	13.0441-6001.2 250126 Dichtungssatz	
13.2541-8001.2210110	13.0441-5416.2 250117	Dichtungssatz	13.2601-8027.2210159	13.0441-6001.2 250126 Dichtungssatz	
13.2541-8002.2210111	13.0441-5416.2 250117	Dichtungssatz	13.2601-8028.2210160	13.0441-6001.2 250126 Dichtungssatz	
13.2541-8008.2210112	13.0441-5411.2 250114	Dichtungssatz	13.2601-8029.2210161	13.0441-6003.2 250128 Dichtungssatz	
13.2541-9998.2210113	13.0441-5409.2 250112	Dichtungssatz	13.2601-8030.2210162	13.0441-6003.2 250128 Dichtungssatz	
13.2541-9999.2210114	13.0441-5409.2 250112	Dichtungssatz	13.2601-8031.2210163	13.0441-6003.2 250128 Dichtungssatz	
13.2544-8001.2210115	13.0441-5417.2 250118 Dichtungssatz 13.0471-5405.2 250136 Rep. Satz Nachstellung 13.0471-5407.2 250137 Verbindungsschrauben 13.0471-5408.2 250138 Rep. Satz Rückstellwelle 13.0471-5409.2 250139 Rep. Satz Bremshebel 13.8158-0020.1 990113 Handbremshebel 13.8158-0021.1 990114 Handbremshebel		13.2601-8032.2210164	13.0441-6003.2 250128 Dichtungssatz	
13.2544-8002.2210116	13.0441-5417.2 250118 Dichtungssatz 13.0471-5405.2 250136 Rep. Satz Nachstellung 13.0471-5407.2 250137 Verbindungsschrauben 13.0471-5408.2 250138 Rep. Satz Rückstellwelle 13.0471-5409.2 250139 Rep. Satz Bremshebel 13.8158-0020.1 990113 Handbremshebel 13.8158-0021.1 990114 Handbremshebel		13.2601-8033.2210165	13.0441-6003.2 250128 Dichtungssatz	
13.2571-8011.2210121	13.0441-5718.2 250120	Dichtungssatz	13.2601-8034.2210166	13.0441-6003.2 250128 Dichtungssatz	
13.2571-8012.2210122	13.0441-5718.2 250120	Dichtungssatz	13.2601-8035.2210167	03.3518-6100.2 390364 Entlüfterventil 03.3518-8000.2 390373 Entlüfterventil 13.0441-6012.2 250133 Dichtungssatz	
13.2571-8013.2210123	13.0441-5718.2 250120	Dichtungssatz	13.2601-8036.2210168	03.3518-6100.2 390364 Entlüfterventil 03.3518-8000.2 390373 Entlüfterventil 13.0441-6012.2 250133 Dichtungssatz	
13.2571-8014.2210124	13.0441-5718.2 250120	Dichtungssatz	13.2601-8037.2210169	03.3518-6100.2 390364 Entlüfterventil 03.3518-8000.2 390373 Entlüfterventil 13.0441-6012.2 250133 Dichtungssatz	
13.2571-8015.2210125	13.0441-5720.2 250122	Dichtungssatz	13.2601-8038.2210170	03.3518-6100.2 390364 Entlüfterventil 03.3518-8000.2 390373 Entlüfterventil 13.0441-6012.2 250133 Dichtungssatz	
13.2571-8016.2210126	13.0441-5720.2 250122	Dichtungssatz	13.2601-9996.2210176	13.0441-6001.2 250126 Dichtungssatz	
13.2571-8023.2210127	13.0441-5724.2 250125	Dichtungssatz	13.2601-9997.2210177	13.0441-6001.2 250126 Dichtungssatz	
13.2571-8024.2210128	13.0441-5724.2 250125	Dichtungssatz	13.4341-8001.2210151	13.0441-3401.2 250044 Dichtungssatz	
13.2571-8027.2210129	13.0441-5720.2 250122	Dichtungssatz	13.4341-8002.2210152	13.0441-3401.2 250044 Dichtungssatz	
13.2571-8028.2210130	13.0441-5720.2 250122	Dichtungssatz	13.4401-8005.2210182	13.0441-4018.2 250083 Dichtungssatz	
13.2571-9994.2210131	13.0441-5720.2 250122	Dichtungssatz	13.4401-8006.2210183	13.0441-4018.2 250083 Dichtungssatz	
13.2571-9995.2210132	13.0441-5720.2 250122	Dichtungssatz	13.4401-8009.2210184	13.0441-4018.2 250083 Dichtungssatz	
13.2571-9998.2210133	13.0441-5718.2 250120	Dichtungssatz	13.4401-8010.2210185	13.0441-4018.2 250083 Dichtungssatz	
13.2571-9999.2210134	13.0441-5718.2 250120	Dichtungssatz	13.4401-8018.2210186	13.0441-4018.2 250083 Dichtungssatz	
13.2601-0179.3210141	13.0441-6012.2 250133	Dichtungssatz	13.4401-8019.2210187	13.0441-4018.2 250083 Dichtungssatz	
13.2601-0180.3210142	13.0441-6012.2 250133	Dichtungssatz	13.4401-8020.2210188	13.0441-4018.2 250083 Dichtungssatz	
13.2601-7015.2210230	03.3518-6100.2 390364 Entlüfterventil 03.3518-8000.2 390373 Entlüfterventil 13.0441-6012.2 250133 Dichtungssatz		13.4401-8021.2210189	13.0441-4018.2 250083 Dichtungssatz	
			13.4401-8022.2210190	13.0441-4018.2 250083 Dichtungssatz	
			13.4401-8027.2210191	13.0441-4016.2 250081 Dichtungssatz	
			13.4401-8028.2210192	13.0441-4016.2 250081 Dichtungssatz	



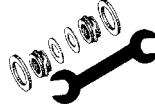

Reparatursätze

Repair kits - Corredi riparazione - Nécessaires de réparation - Juegos de reparación

					
13.4421-8003.2210197	13.0441-4214.2	250091 Dichtungssatz	24.0530-3801.3220161	24.0101-3601.2	260044 Bremssattel-Zubehör
13.4421-8004.2210198	13.0441-4214.2	250091 Dichtungssatz	24.1441-1701.5239001	11.0441-4402.2	250014 Dichtungssatz
13.4421-8007.2210235	13.0441-4214.2	250091 Dichtungssatz	24.1441-1702.5239002	11.0441-4402.2	250014 Dichtungssatz
13.4421-8008.2210236	13.0441-4214.2	250091 Dichtungssatz	24.3301-1703.7220683	24.0101-3802.2	260100 Bremssattel-Zubehör
13.4421-8009.2210228	13.0441-4214.2	250091 Dichtungssatz	24.3301-1704.7220684	24.0101-3802.2	260100 Bremssattel-Zubehör
13.4421-8010.2210229	13.0441-4214.2	250091 Dichtungssatz	24.3304-1701.5240113	24.0101-3004.2	260042 Bremssattel-Zubehör
13.4441-8011.3210216	13.0441-4408.2	250096 Dichtungssatz	24.3304-1702.5240114	24.0101-3004.2	260042 Bremssattel-Zubehör
13.4441-8012.3210217	13.0441-4408.2	250096 Dichtungssatz	24.3304-1703.5240091	24.0101-3004.2	260042 Bremssattel-Zubehör
13.4441-8013.3210199	13.0441-4408.2	250096 Dichtungssatz	24.3304-1704.5240092	24.0101-3004.2	260042 Bremssattel-Zubehör
13.4441-8014.3210200	13.0441-4408.2	250096 Dichtungssatz	24.3304-1707.5240097	24.0101-3001.2	260039 Bremssattel-Zubehör
13.4441-8015.3210201	13.0441-4408.2	250096 Dichtungssatz	24.3304-1708.5240098	24.0101-3001.2	260039 Bremssattel-Zubehör
13.4441-8016.3210202	13.0441-4408.2	250096 Dichtungssatz	24.3331-0037.5240547	11.0441-3305.2	250006 Dichtungssatz
13.4441-8017.3210203	13.0441-4408.2	250096 Dichtungssatz	24.3331-0038.5240548	11.0441-3305.2	250006 Dichtungssatz
13.4441-8018.3210204	13.0441-4408.2	250096 Dichtungssatz	24.3331-8501.5240509	11.0101-5402.2	260009 Hülsensatz
13.4571-0019.3210249	13.0441-5721.2	250123 Dichtungssatz		11.0441-3302.2	250004 Dichtungssatz
13.4571-0020.3210250	13.0441-5721.2	250123 Dichtungssatz		11.8116-0015.1	390492 Haltefeder
13.4571-8005.3210205	13.0441-5721.2	250123 Dichtungssatz		11.8171-0008.1	990049 Führungsbolzen
13.4571-8006.3210206	13.0441-5721.2	250123 Dichtungssatz	24.3331-8502.5240510	11.0101-5402.2	260009 Hülsensatz
13.4574-8005.3210207	13.0441-5721.2	250123 Dichtungssatz		11.0441-3302.2	250004 Dichtungssatz
	24.8190-0029.2	990156 Handbremsbetätigung		11.8116-0015.1	390492 Haltefeder
	13.0441-5721.2	250123 Dichtungssatz		11.8171-0008.1	990049 Führungsbolzen
13.4574-8006.3210208	24.8190-0030.2	990157 Handbremsbetätigung	24.3341-9991.5240511	11.0101-5402.2	260009 Hülsensatz
13.9361-0023.2210241	13.0441-3609.2	250057 Dichtungssatz		11.0441-3401.2	250151 Dichtungssatz
13.9361-0024.2210242	13.0441-3609.2	250057 Dichtungssatz		11.8116-0185.1	390592 Haltefeder
13.9361-0029.2210243	13.0441-3609.2	250057 Dichtungssatz		11.8171-0008.1	990049 Führungsbolzen
13.9361-0030.2210244	13.0441-3609.2	250057 Dichtungssatz	24.3341-9992.5240512	11.0101-5402.2	260009 Hülsensatz
13.9361-0035.2210253	13.0441-3609.2	250057 Dichtungssatz		11.0441-3401.2	250151 Dichtungssatz
13.9361-0036.2210254	13.0441-3609.2	250057 Dichtungssatz		11.8116-0185.1	390592 Haltefeder
13.9544-0021.2210257	13.0441-5417.2	250118 Dichtungssatz	24.3344-1701.5240087	11.8171-0008.1	990049 Führungsbolzen
	13.0471-5405.2	250136 Rep.Satz Nachstellung	24.3344-1702.5240088	24.0101-3401.2	260043 Bremssattel-Zubehör
	13.0471-5407.2	250137 Verbindungsschrauben	24.3344-1702.5240088	24.0101-3401.2	260043 Bremssattel-Zubehör
	13.0471-5408.2	250138 Rep.Satz Rückstellwelle	24.3344-1703.5240117	24.0101-3601.2	260044 Bremssattel-Zubehör
	13.0471-5409.2	250139 Rep.Satz Bremshebel	24.3344-1703.5240117	24.0101-3601.2	260044 Bremssattel-Zubehör
	13.8158-0020.1	990113 Handbremshebel	24.3344-1704.5240118	24.0101-3601.2	260044 Bremssattel-Zubehör
	13.8158-0021.1	990114 Handbremshebel	24.3344-1704.5240118	24.0101-3601.2	260044 Bremssattel-Zubehör
13.9544-0022.2210258	13.0441-5417.2	250118 Dichtungssatz	24.3347-1703.7220685	24.0101-3803.2	260101 Bremssattel-Zubehör
	13.0471-5405.2	250136 Rep.Satz Nachstellung	24.3347-1704.7220686	24.0101-3803.2	260101 Bremssattel-Zubehör
	13.0471-5407.2	250137 Verbindungsschrauben	24.3347-1705.7220751	24.0101-3803.2	260101 Bremssattel-Zubehör
	13.0471-5408.2	250138 Rep.Satz Rückstellwelle	24.3347-1706.7220752	24.0101-3803.2	260101 Bremssattel-Zubehör
	13.0471-5409.2	250139 Rep.Satz Bremshebel	24.3361-8503.5240513	11.0101-5402.2	260009 Hülsensatz
	13.8158-0020.1	990113 Handbremshebel		11.0441-3602.2	250008 Dichtungssatz
	13.8158-0021.1	990114 Handbremshebel		11.8116-0066.1	390577 Haltefeder
				11.8171-0008.1	990049 Führungsbolzen

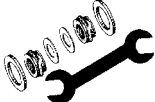



Reparatursätze

Repair kits - Corredi riparazione - Nécessaires de réparation - Juegos de reparación

	 		 
24.3361-8504.5240514	11.0101-5402.2 260009 Hülsensatz 11.0441-3602.2 250008 Dichtungssatz 11.8116-0066.1 390577 Haltefeder 11.8171-0008.1 990049 Führungsbolzen	24.3384-1602.5240014	24.0101-3601.2 260044 Bremssattel-Zubehör
24.3361-9975.5240541	11.0101-5407.2 260011 Hülsensatz 11.0441-3602.2 250008 Dichtungssatz 11.8116-0073.1 390498 Haltefeder 11.8171-0008.1 990049 Führungsbolzen	24.3384-1603.5240015	24.0101-3601.2 260044 Bremssattel-Zubehör
24.3361-9976.5240542	11.0101-5407.2 260011 Hülsensatz 11.0441-3602.2 250008 Dichtungssatz 11.8116-0073.1 390498 Haltefeder 11.8171-0008.1 990049 Führungsbolzen	24.3384-1604.5240016	24.0101-3601.2 260044 Bremssattel-Zubehör
24.3364-1603.5240009	24.0101-3601.2 260044 Bremssattel-Zubehör	24.3384-1703.5240055	24.0101-3601.2 260044 Bremssattel-Zubehör
24.3364-1604.5240010	24.0101-3601.2 260044 Bremssattel-Zubehör	24.3384-1704.5240056	24.0101-3601.2 260044 Bremssattel-Zubehör
24.3364-1605.5240011	11.0101-5403.2 260010 Faltenbalgsatz 24.0101-3601.2 260044 Bremssattel-Zubehör	24.3384-1705.5240063	24.0101-3601.2 260044 Bremssattel-Zubehör
24.3364-1606.5240012	11.0101-5403.2 260010 Faltenbalgsatz 24.0101-3601.2 260044 Bremssattel-Zubehör	24.3384-1706.5240064	24.0101-3601.2 260044 Bremssattel-Zubehör
24.3364-1701.5240053	24.0101-3601.2 260044 Bremssattel-Zubehör	24.3384-1707.5240171	11.0101-5403.2 260010 Faltenbalgsatz 24.0101-3601.2 260044 Bremssattel-Zubehör
24.3364-1702.5240054	24.0101-3601.2 260044 Bremssattel-Zubehör	24.3384-1708.5240172	11.0101-5403.2 260010 Faltenbalgsatz 24.0101-3601.2 260044 Bremssattel-Zubehör
24.3367-1711.7 220753	24.0101-3803.2 260101 Bremssattel-Zubehör	24.3384-1769.7 220791	24.0101-3802.2 260100 Bremssattel-Zubehör
24.3367-1712.7 220754	24.0101-3803.2 260101 Bremssattel-Zubehör	24.3384-1770.7 220792	24.0101-3802.2 260100 Bremssattel-Zubehör
24.3381-1701.5240071	24.0101-3801.2 260045 Bremssattel-Zubehör	24.3387-1707.7 220701	24.0101-3803.2 260101 Bremssattel-Zubehör
24.3381-1702.5240072	24.0101-3801.2 260045 Bremssattel-Zubehör	24.3387-1708.7 220702	24.0101-3803.2 260101 Bremssattel-Zubehör
24.3381-8503.5240515	11.0101-5402.2 260009 Hülsensatz 11.0441-3803.2 250010 Dichtungssatz 11.8116-0066.1 390577 Haltefeder 11.8171-0008.1 990049 Führungsbolzen	24.3387-1717.7 220757	24.0101-3803.2 260101 Bremssattel-Zubehör
24.3381-8504.5240516	11.0101-5402.2 260009 Hülsensatz 11.0441-3803.2 250010 Dichtungssatz 11.8116-0066.1 390577 Haltefeder 11.8171-0008.1 990049 Führungsbolzen	24.3387-1718.7 220758	24.0101-3803.2 260101 Bremssattel-Zubehör
24.3381-9959.5240517	11.0101-5402.2 260009 Hülsensatz 11.0441-3803.2 250010 Dichtungssatz 11.8116-0066.1 390577 Haltefeder 11.8171-0008.1 990049 Führungsbolzen	24.3387-1719.7 220773	24.0101-3803.2 260101 Bremssattel-Zubehör
24.3381-9960.5240518	11.0101-5402.2 260009 Hülsensatz 11.0441-3803.2 250010 Dichtungssatz 11.8116-0066.1 390577 Haltefeder 11.8171-0008.1 990049 Führungsbolzen	24.3387-1720.7 220774	24.0101-3803.2 260101 Bremssattel-Zubehör
24.3381-9961.5240519	11.0101-5402.2 260009 Hülsensatz 11.0441-3803.2 250010 Dichtungssatz 11.8116-0066.1 390577 Haltefeder 11.8171-0008.1 990049 Führungsbolzen	24.3401-1601.5240173	24.0101-3401.2 260043 Bremssattel-Zubehör
24.3381-9962.5240520	11.0101-5402.2 260009 Hülsensatz 11.0441-3803.2 250010 Dichtungssatz 11.8116-0066.1 390577 Haltefeder 11.8171-0008.1 990049 Führungsbolzen	24.3401-1602.5240174	24.0101-3401.2 260043 Bremssattel-Zubehör
24.3384-1601.5240013	24.0101-3601.2 260044 Bremssattel-Zubehör	24.3401-1603.5240017	24.0101-3401.2 260043 Bremssattel-Zubehör 24.0101-3601.2 260044 Bremssattel-Zubehör
		24.3401-1604.5240018	24.0101-3401.2 260043 Bremssattel-Zubehör 24.0101-3601.2 260044 Bremssattel-Zubehör
		24.3401-1703.5240351	11.0101-5402.2 260009 Hülsensatz 11.0441-4002.2 250011 Dichtungssatz 11.8116-0066.1 390577 Haltefeder 11.8171-0008.1 990049 Führungsbolzen
		24.3401-1704.5240352	11.0101-5402.2 260009 Hülsensatz 11.0441-4002.2 250011 Dichtungssatz 11.8116-0066.1 390577 Haltefeder 11.8171-0008.1 990049 Führungsbolzen
		24.3401-1705.5240423	11.0101-5402.2 260009 Hülsensatz 11.0441-4002.2 250011 Dichtungssatz 11.8116-0066.1 390577 Haltefeder 11.8171-0008.1 990049 Führungsbolzen
		24.3401-1706.5240424	11.0101-5402.2 260009 Hülsensatz 11.0441-4002.2 250011 Dichtungssatz 11.8116-0066.1 390577 Haltefeder 11.8171-0008.1 990049 Führungsbolzen

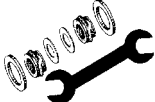



Reparatursätze

Repair kits - Corredi riparazione - Nécessaires de réparation - Juegos de reparación

	 		 
24.3401-8503.5240521	11.0101-5402.2 260009 Hülsensatz 11.0441-4002.2 250011 Dichtungssatz 11.8116-0066.1 390577 Haltefeder 11.8171-0008.1 990049 Führungsbolzen	24.3481-1505.5240047	24.0101-4803.2 260049 Bremssattel-Zubehör
24.3401-8504.5240522	11.0101-5402.2 260009 Hülsensatz 11.0441-4002.2 250011 Dichtungssatz 11.8116-0066.1 390577 Haltefeder 11.8171-0008.1 990049 Führungsbolzen	24.3481-1506.5240048	24.0101-4803.2 260049 Bremssattel-Zubehör
24.3401-9977.5240523	11.0101-5402.2 260009 Hülsensatz 11.0441-4003.2 250001 Dichtungssatz 11.8116-0094.1 390504 Haltefeder 11.8171-0008.1 990049 Führungsbolzen	24.3481-1611.5240029	24.0101-4807.2 260053 Bremssattel-Zubehör
24.3401-9978.5240524	11.0101-5402.2 260009 Hülsensatz 11.0441-4003.2 250001 Dichtungssatz 11.8116-0094.1 390504 Haltefeder 11.8171-0008.1 990049 Führungsbolzen	24.3481-1612.5240030	24.0101-4807.2 260053 Bremssattel-Zubehör
24.3417-1703.7220759	24.0101-3803.2 260101 Bremssattel-Zubehör	24.3481-1615.5240031	24.0101-4806.2 260052 Bremssattel-Zubehör
24.3417-1704.7220760	24.0101-3803.2 260101 Bremssattel-Zubehör	24.3481-1616.5240032	24.0101-4806.2 260052 Bremssattel-Zubehör
24.3421-1705.5240353	11.0101-5402.2 260009 Hülsensatz 11.8116-0296.1 390445 Haltefeder 11.8171-0008.1 990049 Führungsbolzen	24.3481-1617.5240115	24.0101-3601.2 260044 Bremssattel-Zubehör
24.3421-1706.5240354	11.0101-5402.2 260009 Hülsensatz 11.8116-0296.1 390445 Haltefeder 11.8171-0008.1 990049 Führungsbolzen	24.3481-1618.5240116	24.0101-3601.2 260044 Bremssattel-Zubehör
24.3421-9979.5240475	11.0101-5407.2 260011 Hülsensatz 11.8116-0236.1 390507 Haltefeder 11.8171-0008.1 990049 Führungsbolzen	24.3481-1703.5240051	24.0101-4301.2 260047 Bremssattel-Zubehör
24.3421-9980.5240476	11.0101-5407.2 260011 Hülsensatz 11.8116-0236.1 390507 Haltefeder 11.8171-0008.1 990049 Führungsbolzen	24.3481-1704.5240052	24.0101-4301.2 260047 Bremssattel-Zubehör
24.3434-1601.5240019	24.0101-4301.2 260047 Bremssattel-Zubehör	24.3481-1707.5240073	24.0101-3601.2 260044 Bremssattel-Zubehör
24.3434-1602.5240020	24.0101-4301.2 260047 Bremssattel-Zubehör	24.3481-1708.5240074	24.0101-3601.2 260044 Bremssattel-Zubehör
24.3434-1701.5240357	11.0101-5403.2 260010 Faltenbalgsatz	24.3481-1709.5240065	24.0101-4804.2 260050 Bremssattel-Zubehör
24.3434-1702.5240358	11.0101-5403.2 260010 Faltenbalgsatz	24.3481-1710.5240066	24.0101-4804.2 260050 Bremssattel-Zubehör
24.3451-1703.5240059	11.0101-5403.2 260010 Faltenbalgsatz 24.0101-3401.2 260043 Bremssattel-Zubehör	24.3481-1731.5240209	11.0101-5407.2 260011 Hülsensatz 11.0441-4805.2 250020 Dichtungssatz 11.8171-0008.1 990049 Führungsbolzen
24.3451-1704.5240060	11.0101-5403.2 260010 Faltenbalgsatz 24.0101-3401.2 260043 Bremssattel-Zubehör	24.3481-1732.5240210	11.0101-5407.2 260011 Hülsensatz 11.0441-4805.2 250020 Dichtungssatz 11.8171-0008.1 990049 Führungsbolzen
24.3481-0705.5240021	24.0101-4801.2 990131 Bremssattel-Zubehör	24.3481-1733.5240213	11.0101-5407.2 260011 Hülsensatz 11.0441-4811.2 250024 Dichtungssatz 11.8116-0129.1 390591 Haltefeder 11.8171-0008.1 990049 Führungsbolzen
24.3481-0706.5240022	24.0101-4801.2 990131 Bremssattel-Zubehör	24.3481-1734.5240214	11.0101-5407.2 260011 Hülsensatz 11.0441-4811.2 250024 Dichtungssatz 11.8116-0129.1 390591 Haltefeder 11.8171-0008.1 990049 Führungsbolzen
24.3481-0707.5240023	24.0101-4801.2 990131 Bremssattel-Zubehör	24.3481-1735.5240283	11.0101-4801.2 260006 Hülsensatz 11.0441-4808.2 250022 Dichtungssatz 24.0102-4801.2 260085 Hülsensatz+Schrauben
24.3481-0708.5240024	24.0101-4801.2 990131 Bremssattel-Zubehör	24.3481-1736.5240284	11.0101-4801.2 260006 Hülsensatz 11.0441-4808.2 250022 Dichtungssatz 24.0102-4801.2 260085 Hülsensatz+Schrauben
24.3481-0711.5240025	24.0101-4801.2 990131 Bremssattel-Zubehör	24.3481-1745.5240277	11.0101-4803.2 260008 Hülsensatz 11.0441-4808.2 250022 Dichtungssatz 24.0102-4803.2 260086 Hülsensatz+Schrauben
24.3481-0712.5240026	24.0101-4801.2 990131 Bremssattel-Zubehör	24.3481-1746.5240278	11.0101-4803.2 260008 Hülsensatz 11.0441-4808.2 250022 Dichtungssatz 24.0102-4803.2 260086 Hülsensatz+Schrauben
24.3481-0713.5240027	24.0101-4801.2 990131 Bremssattel-Zubehör	24.3481-1747.5240279	11.0101-4803.2 260008 Hülsensatz 11.0441-4808.2 250022 Dichtungssatz 24.0102-4803.2 260086 Hülsensatz+Schrauben
24.3481-0714.5240028	24.0101-4801.2 990131 Bremssattel-Zubehör	24.3481-1748.5240280	11.0101-4803.2 260008 Hülsensatz 11.0441-4808.2 250022 Dichtungssatz 24.0102-4803.2 260086 Hülsensatz+Schrauben

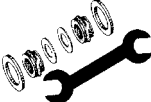



Reparatursätze

Repair kits - Corredi riparazione - Nécessaires de réparation - Juegos de reparación

	 		 
24.3481-1749.5240281	11.0101-4801.2 260006 Hülsensatz 11.0441-4808.2 250022 Dichtungssatz 24.0102-4801.2 260085 Hülsensatz+Schrauben	24.3541-1603.5240037	24.0101-3601.2 260044 Bremssattel-Zubehör
24.3481-1750.5240282	11.0101-4801.2 260006 Hülsensatz 11.0441-4808.2 250022 Dichtungssatz 24.0102-4801.2 260085 Hülsensatz+Schrauben	24.3541-1604.5240038	24.0101-3601.2 260044 Bremssattel-Zubehör
24.3481-1753.5240287	11.0101-4803.2 260008 Hülsensatz 11.0441-4808.2 250022 Dichtungssatz 24.0102-4803.2 260086 Hülsensatz+Schrauben	24.3541-1609.5240039	11.0101-5403.2 260010 Faltenbalgsatz 11.0101-5409.2 260035 Hülsensatz 24.0101-4301.2 260047 Bremssattel-Zubehör
24.3481-1754.5240288	11.0101-4803.2 260008 Hülsensatz 11.0441-4808.2 250022 Dichtungssatz 24.0102-4803.2 260086 Hülsensatz+Schrauben	24.3541-1610.5240040	11.0101-5403.2 260010 Faltenbalgsatz 11.0101-5409.2 260035 Hülsensatz 24.0101-4301.2 260047 Bremssattel-Zubehör
24.3481-1805.7220765	24.0101-3802.2 260100 Bremssattel-Zubehör	24.3541-1611.5240041	24.0101-3401.2 260043 Bremssattel-Zubehör
24.3481-1806.7220766	24.0101-3802.2 260100 Bremssattel-Zubehör	24.3541-1612.5240042	24.0101-3401.2 260043 Bremssattel-Zubehör
24.3481-8515.5240477	11.0101-5407.2 260011 Hülsensatz 11.8116-0264.1 390594 Haltefeder 11.8171-0008.1 990049 Führungsbolzen	24.3541-1619.5240043	24.0101-3601.2 260044 Bremssattel-Zubehör
24.3481-8516.5240478	11.0101-5407.2 260011 Hülsensatz 11.8116-0264.1 390594 Haltefeder 11.8171-0008.1 990049 Führungsbolzen	24.3541-1620.5240044	24.0101-3601.2 260044 Bremssattel-Zubehör
24.3481-9833.5240479	11.0101-5407.2 260011 Hülsensatz 11.0441-4811.2 250024 Dichtungssatz 11.8116-0129.1 390591 Haltefeder 11.8171-0008.1 990049 Führungsbolzen	24.3541-1631.7220325	11.0101-5403.2 260010 Faltenbalgsatz 11.0441-5404.2 250029 Dichtungssatz
24.3481-9834.5240480	11.0101-5407.2 260011 Hülsensatz 11.0441-4811.2 250024 Dichtungssatz 11.8116-0129.1 390591 Haltefeder 11.8171-0008.1 990049 Führungsbolzen	24.3541-1632.7220326	11.0101-5403.2 260010 Faltenbalgsatz 11.0441-5404.2 250029 Dichtungssatz
24.3511-1701.5240101	24.0101-5102.2 260056 Bremssattel-Zubehör	24.3541-1701.5240005	11.0101-5407.2 260011 Hülsensatz 11.0441-5402.2 250028 Dichtungssatz 11.8171-0008.1 990049 Führungsbolzen
24.3511-1702.5240102	24.0101-5102.2 260056 Bremssattel-Zubehör	24.3541-1702.5240006	11.0101-5407.2 260011 Hülsensatz 11.0441-5402.2 250028 Dichtungssatz 11.8171-0008.1 990049 Führungsbolzen
24.3521-0701.7220209	24.0101-4801.2 990131 Bremssattel-Zubehör	24.3541-1705.5240111	24.0101-5405.2 260063 Bremssattel-Zubehör
24.3521-0702.7220210	24.0101-4801.2 990131 Bremssattel-Zubehör	24.3541-1706.5240112	24.0101-5405.2 260063 Bremssattel-Zubehör
24.3521-0705.5240033	24.0101-4801.2 990131 Bremssattel-Zubehör	24.3541-1707.5240067	24.0101-5401.2 260059 Bremssattel-Zubehör
24.3521-0706.5240034	24.0101-4801.2 990131 Bremssattel-Zubehör	24.3541-1708.5240068	24.0101-5401.2 260059 Bremssattel-Zubehör
24.3521-1701.5240001	11.0101-5407.2 260011 Hülsensatz 11.0441-5202.2 250026 Dichtungssatz 11.8116-0097.1 390590 Haltefeder 11.8171-0008.1 990049 Führungsbolzen	24.3541-1711.5240107	24.0101-5102.2 260056 Bremssattel-Zubehör
24.3521-1702.5240002	11.0101-5407.2 260011 Hülsensatz 11.0441-5202.2 250026 Dichtungssatz 11.8116-0097.1 390590 Haltefeder 11.8171-0008.1 990049 Führungsbolzen	24.3541-1712.5240108	24.0101-5102.2 260056 Bremssattel-Zubehör
24.3521-1701.5240481	11.0101-5407.2 260011 Hülsensatz 11.8171-0008.1 990049 Führungsbolzen	24.3541-1717.5240121	24.0101-3601.2 260044 Bremssattel-Zubehör
24.3521-1702.5240482	11.0101-5407.2 260011 Hülsensatz 11.8171-0008.1 990049 Führungsbolzen	24.3541-1718.5240122	24.0101-3601.2 260044 Bremssattel-Zubehör
24.3541-0701.5240035	24.0101-4801.2 990131 Bremssattel-Zubehör	24.3541-1719.5240057	11.0101-5403.2 260010 Faltenbalgsatz 11.0101-5409.2 260035 Hülsensatz 24.0101-4301.2 260047 Bremssattel-Zubehör
24.3541-0702.5240036	24.0101-4801.2 990131 Bremssattel-Zubehör	24.3541-1720.5240058	11.0101-5403.2 260010 Faltenbalgsatz 11.0101-5409.2 260035 Hülsensatz 24.0101-4301.2 260047 Bremssattel-Zubehör
		24.3541-1721.5240075	24.0101-3601.2 260044 Bremssattel-Zubehör
		24.3541-1722.5240076	24.0101-3601.2 260044 Bremssattel-Zubehör
		24.3541-1723.5240077	24.0101-3601.2 260044 Bremssattel-Zubehör
		24.3541-1724.5240078	24.0101-3601.2 260044 Bremssattel-Zubehör
		24.3541-1725.5240003	11.0101-5403.2 260010 Faltenbalgsatz 11.0441-5404.2 250029 Dichtungssatz

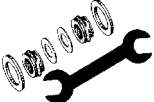

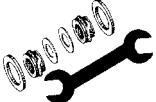



Reparatursätze

Repair kits - Corredi riparazione - Nécessaires de réparation - Juegos de reparación

	 		 
24.3541-1726.5240004	11.0101-5403.2 260010 Faltenbalgsatz 11.0441-5404.2 250029 Dichtungssatz	24.3541-8529.5240553	11.0101-5407.2 260011 Hülsensatz 11.0441-5402.2 250028 Dichtungssatz 11.8116-0264.1 390594 Haltefeder 11.8171-0008.1 990049 Führungsbolzen
24.3541-1731.5240061	24.0101-4301.2 260047 Bremssattel-Zubehör	24.3541-8530.5240554	11.0101-5407.2 260011 Hülsensatz 11.0441-5402.2 250028 Dichtungssatz 11.8116-0264.1 390594 Haltefeder 11.8171-0008.1 990049 Führungsbolzen
24.3541-1732.5240062	24.0101-4301.2 260047 Bremssattel-Zubehör	24.3541-9587.5240527	11.0101-5402.2 260009 Hülsensatz 11.0441-5402.2 250028 Dichtungssatz 11.8116-0109.1 390495 Haltefeder 11.8116-0206.1 390593 Haltefeder 11.8170-0729.1 260107 Halter 11.8170-0730.1 260108 Halter 11.8171-0008.1 990049 Führungsbolzen
24.3541-1739.5240223	11.0101-5403.2 260010 Faltenbalgsatz	24.3541-9588.5240528	11.0101-5402.2 260009 Hülsensatz 11.0441-5402.2 250028 Dichtungssatz 11.8116-0109.1 390495 Haltefeder 11.8116-0206.1 390593 Haltefeder 11.8170-0729.1 260107 Halter 11.8170-0730.1 260108 Halter 11.8171-0008.1 990049 Führungsbolzen
24.3541-1740.5240224	11.0101-5403.2 260010 Faltenbalgsatz	24.3541-9667.5240529	11.0101-5402.2 260009 Hülsensatz 11.0230-0444.1 260104 Halter 11.0441-5402.2 250028 Dichtungssatz 11.8116-0109.1 390495 Haltefeder 11.8116-0206.1 390593 Haltefeder 11.8171-0008.1 990049 Führungsbolzen
24.3541-1773.7220527	11.0101-5403.2 260010 Faltenbalgsatz 24.0101-3401.2 260043 Bremssattel-Zubehör	24.3541-9668.5240530	11.0101-5402.2 260009 Hülsensatz 11.0230-0444.1 260104 Halter 11.0441-5402.2 250028 Dichtungssatz 11.8116-0109.1 390495 Haltefeder 11.8116-0206.1 390593 Haltefeder 11.8171-0008.1 990049 Führungsbolzen
24.3541-1774.7220528	11.0101-5403.2 260010 Faltenbalgsatz 24.0101-3401.2 260043 Bremssattel-Zubehör	24.3546-1707.7220597	11.0101-5407.2 260011 Hülsensatz
24.3541-1779.5240249	11.0101-5403.2 260010 Faltenbalgsatz	24.3546-1708.7220598	11.0101-5407.2 260011 Hülsensatz
24.3541-1780.5240250	11.0101-5403.2 260010 Faltenbalgsatz	24.3571-1703.5240099	24.0101-5701.2 260065 Bremssattel-Zubehör
24.3541-1821.7220695	24.0101-3802.2 260100 Bremssattel-Zubehör	24.3571-1704.5240100	24.0101-5701.2 260065 Bremssattel-Zubehör
24.3541-1822.7220696	24.0101-3802.2 260100 Bremssattel-Zubehör	24.3571-1705.5240069	24.0101-3401.2 260043 Bremssattel-Zubehör
24.3541-8083.5240483	11.0101-5407.2 260011 Hülsensatz 11.8116-0292.1 390521 Haltefeder 11.8171-0008.1 990049 Führungsbolzen	24.3571-1706.5240070	24.0101-3401.2 260043 Bremssattel-Zubehör
24.3541-8084.5240484	11.0101-5407.2 260011 Hülsensatz 11.8116-0292.1 390521 Haltefeder 11.8171-0008.1 990049 Führungsbolzen	24.3571-1707.5240079	24.0101-3601.2 260044 Bremssattel-Zubehör
24.3541-8085.5240525	11.0101-5407.2 260011 Hülsensatz 11.8116-0129.1 390591 Haltefeder 11.8116-0292.1 390521 Haltefeder 11.8171-0008.1 990049 Führungsbolzen	24.3571-1708.5240080	24.0101-3601.2 260044 Bremssattel-Zubehör
24.3541-8086.5240526	11.0101-5407.2 260011 Hülsensatz 11.8116-0129.1 390591 Haltefeder 11.8116-0292.1 390521 Haltefeder 11.8171-0008.1 990049 Führungsbolzen	24.3571-1725.5240313	11.0101-5407.2 260011 Hülsensatz 11.0441-5704.2 250034 Dichtungssatz 11.8116-0292.1 390521 Haltefeder 11.8171-0008.1 990049 Führungsbolzen
24.3541-8105.5240485	11.0101-5407.2 260011 Hülsensatz 11.8171-0008.1 990049 Führungsbolzen	24.3571-1726.5240314	11.0101-5407.2 260011 Hülsensatz 11.0441-5704.2 250034 Dichtungssatz 11.8116-0292.1 390521 Haltefeder 11.8171-0008.1 990049 Führungsbolzen
24.3541-8106.5240486	11.0101-5407.2 260011 Hülsensatz 11.8171-0008.1 990049 Führungsbolzen	24.3571-1733.5240349	11.0101-5402.2 260009 Hülsensatz 11.8116-0273.1 390515 Haltefeder 11.8171-0008.1 990049 Führungsbolzen
24.3541-8521.5240487	11.0101-5409.2 260035 Hülsensatz 11.0441-5405.2 250030 Dichtungssatz		
24.3541-8522.5240488	11.0101-5409.2 260035 Hülsensatz 11.0441-5405.2 250030 Dichtungssatz		
24.3541-8523.5240551	11.0101-5409.2 260035 Hülsensatz 11.0441-5409.2 250031 Dichtungssatz 11.8116-0143.1 390513 Haltefeder 11.8170-0306.1 260102 Halter 11.8171-0008.1 990049 Führungsbolzen		
24.3541-8524.5240552	11.0101-5409.2 260035 Hülsensatz 11.0441-5409.2 250031 Dichtungssatz 11.8116-0143.1 390513 Haltefeder 11.8170-0306.1 260102 Halter 11.8171-0008.1 990049 Führungsbolzen		





Reparatursätze

Repair kits - Corredi riparazione - Nécessaires de réparation - Juegos de reparación

	 		 
24.3571-1734.5240350	11.0101-5402.2 260009 Hülsensatz 11.8116-0273.1 390515 Haltefeder 11.8171-0008.1 990049 Führungsbolzen	24.3571-8521.5240495	11.0101-5409.2 260035 Hülsensatz 11.0441-5704.2 250034 Dichtungssatz 11.8116-0143.1 390513 Haltefeder 11.8170-0306.1 260102 Halter 11.8171-0008.1 990049 Führungsbolzen
24.3571-1739.7220667	24.0101-3803.2 260101 Bremssattel-Zubehör	24.3571-8522.5240496	11.0101-5409.2 260035 Hülsensatz 11.0441-5704.2 250034 Dichtungssatz 11.8116-0143.1 390513 Haltefeder 11.8170-0306.1 260102 Halter 11.8171-0008.1 990049 Führungsbolzen
24.3571-1740.7220668	24.0101-3803.2 260101 Bremssattel-Zubehör	24.3571-9801.5240497	11.0101-5407.2 260011 Hülsensatz 11.8116-0279.1 390519 Haltefeder 11.8171-0008.1 990049 Führungsbolzen
24.3571-1743.7220687	24.0101-3803.2 260101 Bremssattel-Zubehör	24.3571-9802.5240498	11.0101-5407.2 260011 Hülsensatz 11.8116-0279.1 390519 Haltefeder 11.8171-0008.1 990049 Führungsbolzen
24.3571-1744.7220688	24.0101-3803.2 260101 Bremssattel-Zubehör	24.3571-9811.5240531	11.0101-5407.2 260011 Hülsensatz 11.0101-5706.2 260097 Hülsensatz 11.0441-5704.2 250034 Dichtungssatz 11.8116-0326.1 390471 Haltefeder 11.8171-0008.1 990049 Führungsbolzen 11.8171-0067.1 250153 Führungsbolzen
24.3571-1745.7220689	24.0101-3802.2 260100 Bremssattel-Zubehör	24.3571-9812.5240532	11.0101-5407.2 260011 Hülsensatz 11.0101-5706.2 260097 Hülsensatz 11.0441-5704.2 250034 Dichtungssatz 11.8116-0326.1 390471 Haltefeder 11.8171-0008.1 990049 Führungsbolzen 11.8171-0067.1 250153 Führungsbolzen
24.3571-1746.7220690	24.0101-3802.2 260100 Bremssattel-Zubehör	24.3571-9813.5240557	11.0101-5407.2 260011 Hülsensatz 11.8116-0356.1 390586 Haltefeder 11.8171-0008.1 990049 Führungsbolzen
24.3571-1747.7220691	24.0101-3802.2 260100 Bremssattel-Zubehör	24.3571-9814.5240558	11.0101-5407.2 260011 Hülsensatz 11.8116-0356.1 390586 Haltefeder 11.8171-0008.1 990049 Führungsbolzen
24.3571-1748.7220692	24.0101-3802.2 260100 Bremssattel-Zubehör	24.3571-9823.5240499	11.0101-5407.2 260011 Hülsensatz 11.0441-5704.2 250034 Dichtungssatz 11.8116-0292.1 390521 Haltefeder 11.8171-0008.1 990049 Führungsbolzen
24.3571-1749.7220693	24.0101-3802.2 260100 Bremssattel-Zubehör	24.3571-9824.5240500	11.0101-5407.2 260011 Hülsensatz 11.0441-5704.2 250034 Dichtungssatz 11.8116-0292.1 390521 Haltefeder 11.8171-0008.1 990049 Führungsbolzen
24.3571-1750.7220694	24.0101-3802.2 260100 Bremssattel-Zubehör	24.3571-9841.5240501	11.0101-5407.2 260011 Hülsensatz 11.8171-0008.1 990049 Führungsbolzen
24.3571-1761.5240461	11.0101-5407.2 260011 Hülsensatz 11.0441-5704.2 250034 Dichtungssatz 11.8116-0292.1 390521 Haltefeder 11.8171-0008.1 990049 Führungsbolzen	24.3571-9842.5240502	11.0101-5407.2 260011 Hülsensatz 11.8171-0008.1 990049 Führungsbolzen
24.3571-1762.5240462	11.0101-5407.2 260011 Hülsensatz 11.0441-5704.2 250034 Dichtungssatz 11.8116-0292.1 390521 Haltefeder 11.8171-0008.1 990049 Führungsbolzen	24.3601-1601.5240203	11.0101-5403.2 260010 Faltenbalgsatz
24.3571-8505.5240489	11.0101-5409.2 260035 Hülsensatz 11.0441-5704.2 250034 Dichtungssatz 11.8116-0143.1 390513 Haltefeder 11.8171-0008.1 990049 Führungsbolzen	24.3601-1602.5240204	11.0101-5403.2 260010 Faltenbalgsatz
24.3571-8506.5240490	11.0101-5409.2 260035 Hülsensatz 11.0441-5704.2 250034 Dichtungssatz 11.8116-0143.1 390513 Haltefeder 11.8171-0008.1 990049 Führungsbolzen	24.3601-1701.5240007	11.0101-5407.2 260011 Hülsensatz 11.0441-6003.2 250037 Dichtungssatz 11.8171-0008.1 990049 Führungsbolzen
24.3571-8507.5240555	11.8170-0306.1 260102 Halter	24.3601-1702.5240008	11.0101-5407.2 260011 Hülsensatz 11.0441-6003.2 250037 Dichtungssatz 11.8171-0008.1 990049 Führungsbolzen
24.3571-8508.5240556	11.8170-0306.1 260102 Halter		
24.3571-8511.5240491	11.0101-5407.2 260011 Hülsensatz 11.0441-5703.2 250145 Dichtungssatz 11.8116-0253.1 390512 Haltefeder 11.8170-0401.1 260103 Halter 11.8171-0008.1 990049 Führungsbolzen		
24.3571-8512.5240492	11.0101-5407.2 260011 Hülsensatz 11.0441-5703.2 250145 Dichtungssatz 11.8116-0253.1 390512 Haltefeder 11.8170-0401.1 260103 Halter 11.8171-0008.1 990049 Führungsbolzen		
24.3571-8517.5240493	11.0101-5409.2 260035 Hülsensatz 11.0441-5704.2 250034 Dichtungssatz 11.8116-0143.1 390513 Haltefeder 11.8171-0008.1 990049 Führungsbolzen		
24.3571-8518.5240494	11.0101-5409.2 260035 Hülsensatz 11.0441-5704.2 250034 Dichtungssatz 11.8116-0143.1 390513 Haltefeder 11.8171-0008.1 990049 Führungsbolzen		

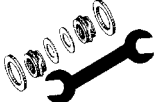





Reparatursätze

Repair kits - Corredi riparazione - Nécessaires de réparation - Juegos de reparación

	 		 
24.3601-1709.5240275	11.0101-6004.2 260014 Hülsensatz 11.0441-6003.2 250037 Dichtungssatz	24.3601-8528.5240504	11.0101-5407.2 260011 Hülsensatz 11.0230-0170.2 260078 Haltersatz 11.0441-6007.2 250146 Dichtungssatz 11.8116-0301.1 390610 Haltefeder 11.8171-0008.1 990049 Führungsbolzen
24.3601-1710.5240276	11.0101-6004.2 260014 Hülsensatz 11.0441-6003.2 250037 Dichtungssatz	24.3601-9785.5240545	11.0101-5706.2 260097 Hülsensatz 11.0441-6008.2 250038 Dichtungssatz 11.8116-0237.1 390509 Haltefeder 11.8171-0067.1 250153 Führungsbolzen
24.3601-1713.5240355	11.0101-5402.2 260009 Hülsensatz 11.0441-6003.2 250037 Dichtungssatz 11.8116-0197.1 390523 Haltefeder 11.8116-0290.2 390520 Haltefeder 11.8170-0530.1 260115 Halter 11.8171-0008.1 990049 Führungsbolzen	24.3601-9786.5240546	11.0101-5706.2 260097 Hülsensatz 11.0441-6008.2 250038 Dichtungssatz 11.8116-0237.1 390509 Haltefeder 11.8171-0067.1 250153 Führungsbolzen
24.3601-1714.5240356	11.0101-5402.2 260009 Hülsensatz 11.0441-6003.2 250037 Dichtungssatz 11.8116-0197.1 390523 Haltefeder 11.8116-0290.2 390520 Haltefeder 11.8170-0530.1 260115 Halter 11.8171-0008.1 990049 Führungsbolzen	24.3601-9787.5240505	11.0101-5407.2 260011 Hülsensatz 11.0441-6008.2 250038 Dichtungssatz 11.8171-0008.1 990049 Führungsbolzen
24.3601-8501.5240533	11.0101-5402.2 260009 Hülsensatz 11.0230-0020.2 260023 Haltersatz 11.0441-6003.2 250037 Dichtungssatz 11.8116-0083.1 390501 Haltefeder 11.8171-0008.1 990049 Führungsbolzen	24.3601-9788.5240506	11.0101-5407.2 260011 Hülsensatz 11.0441-6008.2 250038 Dichtungssatz 11.8171-0008.1 990049 Führungsbolzen
24.3601-8502.5240534	11.0101-5402.2 260009 Hülsensatz 11.0230-0020.2 260023 Haltersatz 11.0441-6003.2 250037 Dichtungssatz 11.8116-0083.1 390501 Haltefeder 11.8171-0008.1 990049 Führungsbolzen	24.3601-9829.5240507	11.0101-5407.2 260011 Hülsensatz 11.8116-0366.2 390587 Haltefeder 11.8171-0008.1 990049 Führungsbolzen 11.8171-0067.1 250153 Führungsbolzen
24.3601-8503.5240535	11.0101-5402.2 260009 Hülsensatz 11.0441-6003.2 250037 Dichtungssatz 11.8116-0083.1 390501 Haltefeder 11.8171-0008.1 990049 Führungsbolzen	24.3601-9830.5240508	11.0101-5407.2 260011 Hülsensatz 11.8116-0366.2 390587 Haltefeder 11.8171-0008.1 990049 Führungsbolzen 11.8171-0067.1 250153 Führungsbolzen
24.3601-8504.5240536	11.0101-5402.2 260009 Hülsensatz 11.0441-6003.2 250037 Dichtungssatz 11.8116-0083.1 390501 Haltefeder 11.8171-0008.1 990049 Führungsbolzen	24.9235-0013.5230001	13.0441-3506.2 250052 Dichtungssatz
24.3601-8505.5240537	11.0101-5402.2 260009 Hülsensatz 11.0441-6003.2 250037 Dichtungssatz 11.8116-0083.1 390501 Haltefeder 11.8171-0008.1 990049 Führungsbolzen	24.9235-0014.5230002	13.0441-3506.2 250052 Dichtungssatz
24.3601-8506.5240538	11.0101-5402.2 260009 Hülsensatz 11.0441-6003.2 250037 Dichtungssatz 11.8116-0083.1 390501 Haltefeder 11.8171-0008.1 990049 Führungsbolzen	24.9235-0051.5230003	13.0441-3507.2 250053 Dichtungssatz
24.3601-8511.5240539	11.0101-5402.2 260009 Hülsensatz 11.0441-6003.2 250037 Dichtungssatz 11.8116-0092.1 390503 Haltefeder 11.8171-0008.1 990049 Führungsbolzen	24.9235-0052.5230004	13.0441-3507.2 250053 Dichtungssatz
24.3601-8512.5240540	11.0101-5402.2 260009 Hülsensatz 11.0441-6003.2 250037 Dichtungssatz 11.8116-0092.1 390503 Haltefeder 11.8171-0008.1 990049 Führungsbolzen	24.9235-8005.5230023	13.0441-3505.2 250051 Dichtungssatz
24.3601-8527.5240503	11.0101-5407.2 260011 Hülsensatz 11.0230-0170.2 260078 Haltersatz 11.0441-6007.2 250146 Dichtungssatz 11.8116-0301.1 390610 Haltefeder 11.8171-0008.1 990049 Führungsbolzen	24.9235-8006.5230024	13.0441-3505.2 250051 Dichtungssatz
		24.9236-8001.5230007	13.0441-3606.2 250147 Dichtungssatz
		24.9236-8002.5230008	13.0441-3606.2 250147 Dichtungssatz
		24.9236-8003.5230009	13.0441-3609.2 250057 Dichtungssatz
		24.9236-8004.5230010	13.0441-3609.2 250057 Dichtungssatz
		24.9238-0087.5230035	13.0441-3819.2 250072 Dichtungssatz
		24.9238-0088.5230036	13.0441-3819.2 250072 Dichtungssatz
		24.9238-8027.5230011	13.0441-3811.2 250067 Dichtungssatz
		24.9238-8028.5230012	13.0441-3811.2 250067 Dichtungssatz
		24.9238-8029.5230013	13.0441-3811.2 250067 Dichtungssatz
		24.9238-8030.5230014	13.0441-3811.2 250067 Dichtungssatz
		24.9238-8033.5230015	13.0441-3817.2 250071 Dichtungssatz
		24.9238-8034.5230016	13.0441-3817.2 250071 Dichtungssatz

Reparatursätze

Repair kits - Corredi riparazione - Nécessaires de réparation - Juegos de reparación

					
24.9238-8035.5230025	13.0441-3817.2	250071	Dichtungssatz		
24.9238-8036.5230026	13.0441-3817.2	250071	Dichtungssatz		
24.9240-0027.5230017	13.0441-4014.2	250079	Dichtungssatz		
24.9240-0028.5230018	13.0441-4014.2	250079	Dichtungssatz		
24.9240-0039.5230055	13.0441-4022.2	250149	Dichtungssatz		
24.9240-0040.5230056	13.0441-4022.2	250149	Dichtungssatz		
24.9240-8013.5230019	13.0441-4020.2	250084	Dichtungssatz		
24.9240-8014.5230020	13.0441-4020.2	250084	Dichtungssatz		
24.9242-8005.5230027	13.0441-4205.2	250086	Dichtungssatz		
24.9242-8006.5230028	13.0441-4205.2	250086	Dichtungssatz		
24.9242-8007.5230029	13.0441-4205.2	250086	Dichtungssatz		
24.9242-8008.5230030	13.0441-4205.2	250086	Dichtungssatz		
24.9242-8021.5230031	13.0441-4206.2	250087	Dichtungssatz		
24.9242-8022.5230032	13.0441-4206.2	250087	Dichtungssatz		
24.9246-8001.5230021	13.0441-4601.2	250099	Dichtungssatz		
24.9246-8002.5230022	13.0441-4601.2	250099	Dichtungssatz		
24.9257-8023.5230033	13.0441-5724.2	250125	Dichtungssatz		
24.9257-8024.5230034	13.0441-5724.2	250125	Dichtungssatz		
24.9257-8027.5230039	13.0441-5720.2	250122	Dichtungssatz		
24.9257-8028.5230040	13.0441-5720.2	250122	Dichtungssatz		
24.9260-8025.5230041	13.0441-6001.2	250126	Dichtungssatz		
24.9260-8026.5230042	13.0441-6001.2	250126	Dichtungssatz		
24.9260-8029.5230043	13.0441-6003.2	250128	Dichtungssatz		
24.9260-8030.5230044	13.0441-6003.2	250128	Dichtungssatz		
24.9260-8031.5230045	13.0441-6003.2	250128	Dichtungssatz		
24.9260-8032.5230046	13.0441-6003.2	250128	Dichtungssatz		
24.9440-8027.5230051	13.0441-4016.2	250081	Dichtungssatz		
24.9440-8028.5230052	13.0441-4016.2	250081	Dichtungssatz		
24.9442-8003.5230053	13.0441-4214.2	250091	Dichtungssatz		
24.9442-8004.5230054	13.0441-4214.2	250091	Dichtungssatz		
24.9936-0035.5230047	13.0441-3609.2	250057	Dichtungssatz		
24.9936-0036.5230048	13.0441-3609.2	250057	Dichtungssatz		



A large rectangular area containing 30 horizontal lines, intended for writing or drawing.



A large rectangular area containing 30 horizontal lines, spaced evenly for writing.



Ⓓ **Vergleichsliste**

Ⓔ **Cross reference list**



Ⓕ **Liste des correspondances**

Ⓖ **Lista referencias**

Vergleichsliste

Cross reference list - Tabella di conversione codici



Liste des correspondances - Lista referencias

ALFA ROMEO 	ALFA ROMEO 	BMW 
10133.60000.00	83.7704-0281.3 330804	533991
101336	83.7704-0281.3 330804	542407
102487	83.7704-0281.3 330804	548195
10512.12050.00	03.2525-1802.3 040025	54911.40000.00/00
10512.12050.01	03.2525-1802.3 040025	54968.60000.00/00
10512.22014.00	24.0113-0102.2 413102	60565637
10512.45028.01	03.6048-0601.3 320052	60565638
10512.45050.00	03.3558-0676.3 310077	60749883
10514.22052.03/16	13.0441-4819.2 250104	60801383
10514.22052.03/25	13.0460-4035.2 604035	60801577
10514.22052.30/30	13.0460-6027.2 606027	60801790
10514.22053.03/30	13.0460-4035.2 604035	700487
10514.26004.02/16	13.0441-3001.2 250041	70049.50000.00
10514.26020.00	03.0137-0149.2 650149	700495
10526.26003.00/30	13.0460-3011.2 603011	705109
10541.22052.00/25	13.0460-6027.2 606027	70596.60000.00/00
10541.22053.00/25	13.0460-6027.2 606027	795024
10541.22053.00/30	13.0460-6027.2 606027	795026
10548.12050.00	03.2525-1802.3 040025	795341
10548.12050.01	03.2525-1802.3 040025	795356
10548.12050.01/27	03.0450-2509.2 082509	795357
10548.12050.02	03.2525-1802.3 040025	795402
10548.26003.01/16	13.0441-3803.2 250060	9945750
10548.26003.01/25	13.0460-3011.2 603011	9945815
10548.26003.01/30	13.0460-3011.2 603011	9945816
10548.26003.03/16	13.0441-3803.2 250060	9946023
10548.26215.00	24.0109-0101.1 409101	
10548.45020.03	03.2120-4504.3 010123	BMW
10548.45020.04	03.2120-4504.3 010123	21 52 1 101 692
10564.12050.00/27	03.0450-2510.2 082510	21 52 1 101 737
10564.12051.01	03.2417-0301.3 030004	21 52 1 102 060
10564.45020.00	03.2122-0142.3 010128	21 52 1 102 061
107101	83.7704-0281.3 330804	21 52 1 102 625
11305.18051.00/00	03.2419-8900.3 030024	21 52 1 104 269
11305.18051.01	03.2419-8900.3 030024	21 52 1 104 510
11305.18051.01/00	03.2419-8900.3 030024	21 52 1 106 516
11305.45050.00	03.3558-0676.3 310077	21 52 1 113 379
11315.18051.00	03.2419-8900.3 030024	21 52 1 113 875
11348.22052.00/30	13.0460-4019.2 604019	21 52 1 114 536
11348.26003.00/30	13.0460-3013.2 603013	21 52 1 114 537
11352.22045.01/01	13.0460-4035.2 604035	21 52 1 114 538
11502.45544.00	24.5307-0320.3 330703	21 52 1 116 300
11538.45056.00	24.5307-0320.3 330703	21 52 1 116 302
11568.22052.01/30	13.0460-6027.2 606027	21 52 1 116 303
11600.12051.11	03.2419-8601.3 030022	21 52 1 150 449
11633.22052.00/30	13.0460-4035.2 604035	21 52 1 150 451
11633.26003.00/30	13.0460-3011.2 603011	21 52 1 150 782
11646.22014.02.00	24.0122-0119.2 422119	21 52 1 152 580
11646.26215.01.00	24.0110-0179.1 410179	21 52 1 152 581
11646.45050.00	03.3558-0676.3 310077	21 52 1 152 584
11650.26215.00	24.0110-0166.1 410166	21 52 1 152 658
11650.45049.00	03.2122-0142.3 010128	21 52 1 153 512
11650.45050.00	03.3558-0676.3 310077	21 52 1 153 513
11650.45050.08	03.3558-0676.3 310077	21 52 1 153 520
11655.18051.00	03.2419-8601.3 030022	21 52 1 154 580
11655.22045.00/01	13.0460-4019.2 604019	21 52 1 155 425
11655.26055.00/01	13.0460-3013.2 603013	21 52 1 156 000
11900.26004.04/16	13.0441-4212.2 250089	21 52 1 156 004
130474	24.0113-0171.1 413171	21 52 1 156 673
14020.22008.00/13	03.3518-6100.2 390364	21 52 1 157 346
14020.22038.00/13	03.3518-6100.2 390364	21 52 1 158 677
14020.22038.02/16	13.0441-4018.2 250083	21 52 1 158 903
16100.26003.00/30	13.0460-3013.2 603013	21 52 1 159 537
16200.32050.01/00	03.3558-0676.3 310077	21 52 1 159 714
16414.22052.01/30	13.0460-2980.2 602980	21 52 1 161 874
16416.26003.01/30	13.0460-2962.2 602962	21 52 4 648 052
16420.22023.03/00	24.0120-0129.1 420129	21 52 4 648 146
16420.22413.01/00	13.0460-2962.2 602962	21 52 6 766 277
16420.26003.00/30	13.0460-2962.2 602962	21 52 6 775 924
510364	03.2419-8000.3 030017	32 10 1 157 375
510829	03.2525-2201.3 040026	
	03.2419-8000.3 030017	03.2525-2201.3 040026
	03.2419-8000.3 030017	03.2419-8000.3 030017
	03.2419-8000.3 030017	24.0122-0128.1 422128
	03.2419-8000.3 030017	24.0122-0128.1 422128
	03.2419-8000.3 030017	83.7704-0281.3 330804
	03.2419-8000.3 030017	83.7704-0281.3 330804
	03.2419-8000.3 030017	24.0122-0128.1 422128
	24.3344-1703.5 240117	83.7704-0281.3 330804
	24.3344-1703.5 240117	03.2419-8000.3 030017
	24.3344-1703.5 240118	03.2419-8000.3 030017
	03.0137-0139.2 650139	24.3344-1703.5 240117
	24.3727-0514.2 580514	03.0137-0139.2 650139
	03.2525-2201.3 040026	24.3727-0514.2 580514
	03.2525-2201.3 040026	24.3727-0514.2 580514
	24.3727-0514.2 580514	03.2525-2201.3 040026
	03.2119-6207.3 010060	24.3727-0514.2 580514
	03.2119-6207.3 010060	03.2119-6207.3 010060
	03.2119-6207.3 010060	03.2119-6207.3 010060
	03.2119-6207.3 010060	03.2119-6207.3 010060
	03.0137-9125.2 669125	03.2119-6207.3 010060
	13.0441-4212.2 250089	03.0137-9125.2 669125
	13.0441-3302.2 250042	13.0441-4212.2 250089
	13.0460-3905.2 603905	13.0441-3302.2 250042
	13.0460-3905.2 603905	13.0460-3905.2 603905
	13.0460-7055.2 607055	13.0460-3905.2 603905
	13.0460-2969.2 602969	13.0460-7055.2 607055
	13.0460-2962.2 602962	13.0460-2969.2 602969
	13.0460-2980.2 602980	13.0460-2962.2 602962
	13.0460-2980.2 602980	13.0460-2980.2 602980
	13.0460-2809.2 602809	13.0460-2980.2 602980
		13.0460-2809.2 602809
		03.2419-7800.3 030016
		03.2519-1402.3 040005
		03.2522-3001.3 040013
		03.2520-1001.3 040009
		03.0350-1919.2 071919
		03.2520-1001.3 040009
		03.2419-7800.3 030016
		03.2522-3601.3 040014
		03.2519-1402.3 040005
		03.0450-2006.2 082006
		03.2522-3601.3 040014
		03.2520-1201.3 040011
		03.2419-9000.3 030025
		03.2520-1201.3 040011
		03.2419-9000.3 030025
		03.2419-9000.3 030025
		03.2419-9000.3 030025
		03.2522-3601.3 040014
		03.2419-9000.3 030025
		24.5905-0320.3 330058
		24.5802-0320.3 330050
		24.5802-0320.3 330050
		24.2419-0912.3 030044
		24.5905-0320.3 330058
		24.5802-0320.3 330050
		03.2520-1201.3 040011
		24.2419-0912.3 030044
		24.2419-0922.3 030051
		24.2419-0912.3 030044
		03.2419-9000.3 030025
		24.5802-0320.3 330050
		03.2522-3601.3 040014
		03.2522-3601.3 040014
		24.2522-0905.3 040042
		24.2526-0902.3 040052
		24.5905-0320.3 330058
		24.2526-0902.3 040052
		03.2519-1402.3 040005
		03.0350-1508.2 071508
		24.2522-0905.3 040042
		24.2522-0905.3 040042
		24.5905-0320.3 330058
		34 11 1 100 736
		34 11 1 101 093
		34 11 1 101 094
		34 11 1 101 843
		34 11 1 101 844
		34 11 1 103 207
		34 11 1 103 236
		34 11 1 103 245
		34 11 1 103 289
		34 11 1 103 321
		34 11 1 103 723
		34 11 1 103 726
		34 11 1 103 744
		34 11 1 104 273
		34 11 1 104 274
		34 11 1 104 944
		34 11 1 105 388
		34 11 1 111 649
		34 11 1 113 664
		34 11 1 115 937
		34 11 1 115 938
		34 11 1 116 618
		34 11 1 116 619
		34 11 1 116 940
		34 11 1 116 947
		34 11 1 117 002
		34 11 1 117 352
		34 11 1 117 422
		34 11 1 117 537
		34 11 1 117 538
		34 11 1 117 979
		34 11 1 118 517
		34 11 1 119 112
		34 11 1 119 175
		34 11 1 119 176
		34 11 1 119 177
		34 11 1 119 201
		34 11 1 119 248
		34 11 1 119 563
		34 11 1 119 564
		34 11 1 121 902
		34 11 1 121 938
		34 11 1 150 251
		34 11 1 150 252
		34 11 1 150 253
		34 11 1 150 254
		34 11 1 150 259
		34 11 1 150 260
		34 11 1 150 387
		34 11 1 150 524
		34 11 1 150 527
		34 11 1 150 540
		34 11 1 150 550
		34 11 1 150 554
		34 11 1 151 632
		34 11 1 151 655
		34 11 1 151 656
		34 11 1 152 295
		34 11 1 152 296
		34 11 1 152 297
		34 11 1 152 607
		34 11 1 153 195
		34 11 1 153 200
		34 11 1 153 202
		34 11 1 153 203
		34 11 1 153 208
		34 11 1 153 228
		34 11 1 153 303
		34 11 1 154 379
		34 11 1 154 380
		34 11 1 154 443
		13.0460-5029.2 605029
		13.4401-8021.2 210189
		13.4401-8022.2 210190
		13.4341-8002.2 210152
		13.4341-8001.2 210151
		13.0460-9030.2 609030
		03.3518-6100.2 390364
		13.0441-5406.2 250110

Vergleichsliste

Cross reference list - Tabella di conversione codici

Liste des correspondances - Lista referencias



BMW		BMW		BMW				
34 11 1 154 611	13.0460-7046.2	607046	34 11 1 161 347	13.0460-2921.2	602921	34 21 1 121 387	24.0110-0174.1	410174
34 11 1 154 747	24.0113-0167.1	413167	34 11 1 161 349	13.0460-2921.2	602921	34 21 1 150 159	13.0460-0121.2	610121
34 11 1 154 749	24.0122-0122.1	422122	34 11 1 161 693	24.0112-0124.1	412124	34 21 1 150 273	13.2421-8005.2	210053
34 11 1 154 749	24.0322-0122.1	522122	34 11 1 161 717	13.0460-7046.2	607046	34 21 1 150 273	24.9242-8005.5	230027
34 11 1 154 750	24.0122-0122.1	422122	34 11 1 162 481	13.0460-2921.2	602921	34 21 1 150 274	13.2421-8006.2	210054
34 11 1 154 750	24.0322-0122.1	522122	34 11 1 162 535	13.0460-6033.2	606033	34 21 1 150 274	24.9242-8006.5	230028
34 11 1 154 974	24.0125-0100.1	425100	34 11 1 163 126	24.0122-0112.1	422112	34 21 1 150 275	13.2421-8005.2	210053
34 11 1 155 076	13.0460-7046.2	607046	34 11 1 163 128	24.0113-0138.1	413138	34 21 1 150 275	24.9242-8005.5	230027
34 11 1 155 998	13.0460-2921.2	602921	34 11 1 163 130	24.0122-0111.1	422111	34 21 1 150 276	13.2421-8006.2	210054
34 11 1 155 999	13.0460-2921.2	602921	34 11 1 163 134	24.0112-0111.1	412111	34 21 1 150 276	24.9242-8006.5	230028
34 11 1 156 124	24.0113-0139.1	413139	34 11 1 163 136	24.0122-0135.1	422135	34 21 1 150 545	13.0460-0121.2	610121
34 11 1 156 128	24.0113-0139.1	413139	34 11 1 163 141	24.0125-0100.1	425100	34 21 1 150 556	13.0460-3024.2	603024
34 11 1 156 143	24.0125-0104.1	425104	34 11 1 163 142	24.0125-0100.1	425100	34 21 1 150 557	13.0460-0125.2	610125
34 11 1 156 898	13.0460-2921.2	602921	34 11 1 163 144	24.0113-0139.1	413139	34 21 1 151 633	11.3331-8501.2	220004
34 11 1 156 899	13.0460-2921.2	602921	34 11 1 163 147	24.0125-0104.1	425104	34 21 1 151 633	24.3331-8501.5	240509
34 11 1 157 037	11.0441-6003.2	250037	34 11 1 163 148	24.0125-0104.1	425104	34 21 1 151 634	11.3331-8502.2	220005
34 11 1 157 038	11.0101-5402.2	260009	34 11 1 163 415	11.0101-6004.2	260014	34 21 1 151 634	24.3331-8502.5	240510
34 11 1 157 041	11.8171-0008.1	990049	34 11 1 163 433	11.0441-6003.2	250037	34 21 1 151 635	11.3331-8501.2	220004
34 11 1 157 043	11.0441-4810.2	250023	34 11 1 165 263	24.0128-0122.1	428122	34 21 1 151 635	24.3331-8501.5	240509
34 11 1 157 389	24.3601-8503.5	240535	34 11 2 061 000	03.3217-0301.3	020022	34 21 1 151 636	11.3331-8502.2	220005
34 11 1 157 390	24.3601-8504.5	240536	34 11 2 225 107	24.8190-0214.2	620214	34 21 1 151 636	24.3331-8502.5	240510
34 11 1 157 495	11.3601-8501.2	220145	34 11 2 226 009	13.0460-9037.2	609037	34 21 1 152 221	24.0110-0176.1	410176
34 11 1 157 495	24.3601-8501.5	240533	34 11 2 226 084	13.0460-7046.2	607046	34 21 1 152 298	24.0110-0147.1	410147
34 11 1 157 496	24.3601-8502.5	240534	34 11 2 226 203	11.8116-0091.1	390502	34 21 1 153 194	11.0441-3302.2	250004
34 11 1 157 501	11.3601-8505.2	220149	34 11 2 226 407	24.3601-8503.5	240535	34 21 1 153 196	13.0460-7047.2	607047
34 11 1 157 501	24.3601-8505.5	240537	34 11 2 226 408	24.3601-8504.5	240536	34 21 1 153 199	11.8116-0015.1	390492
34 11 1 157 502	24.3601-8506.5	240538	34 11 2 227 331	13.0460-9037.2	609037	34 21 1 153 241	11.3331-8501.2	220004
34 11 1 157 510	13.0460-7046.2	607046	34 11 2 227 670	11.8116-0083.1	390501	34 21 1 153 241	24.3331-8501.5	240509
34 11 1 157 561	13.0460-7046.2	607046	34 11 2 227 863	13.0460-9037.2	609037	34 21 1 153 242	11.3331-8502.2	220005
34 11 1 157 569	13.0460-6033.2	606033	34 11 2 228 248	13.0460-6033.2	606033	34 21 1 153 242	24.3331-8502.5	240510
34 11 1 157 687	11.8116-0083.1	390501	34 11 2 266 206	11.8116-0091.1	390502	34 21 1 153 243	11.3331-8501.2	220004
34 11 1 157 747	13.0460-2921.2	602921	34 11 2 282 554	13.0460-6033.2	606033	34 21 1 153 243	24.3331-8501.5	240509
34 11 1 157 748	13.0460-2921.2	602921	34 11 2 283 363	11.8116-0315.2	390447	34 21 1 153 244	11.3331-8502.2	220005
34 11 1 157 813	13.0460-6033.2	606033	34 11 2 660 198	13.0441-5406.2	250110	34 21 1 153 244	24.3331-8502.5	240510
34 11 1 157 923	13.0460-7046.2	607046	34 11 6 752 434	24.0113-0167.1	413167	34 21 1 153 881	03.0137-9076.2	669076
34 11 1 158 038	24.0128-0101.1	428101	34 11 6 756 090	24.0128-0101.1	428101	34 21 1 153 883	03.0137-9076.2	669076
34 11 1 158 040	24.0122-0103.1	422103	34 11 6 757 253	11.8116-0315.2	390447	34 21 1 153 884	03.0137-9076.2	669076
34 11 1 158 040	24.0322-0103.1	522103	34 11 6 757 746	24.0130-0101.1	430101	34 21 1 154 236	03.3220-3201.3	020065
34 11 1 158 042	24.0112-0124.1	412124	34 11 6 773 126	11.0441-6007.2	250146	34 21 1 154 385	03.0137-0151.2	650151
34 11 1 158 200	11.8171-0008.1	990049	34 21 1 101 741	24.0223-0005.1	480035	34 21 1 154 398	13.0460-7036.2	607036
34 11 1 158 265	13.0460-6033.2	606033	34 21 1 101 760	24.3215-1105.3	020159	34 21 1 154 448	03.0137-9076.2	669076
34 11 1 158 316	13.0460-2921.2	602921	34 21 1 103 392	03.3222-4211.3	020075	34 21 1 154 599	11.3331-8501.2	220004
34 11 1 158 550	24.0128-0122.1	428122	34 21 1 103 482	13.0441-4205.2	250086	34 21 1 154 599	24.3331-8501.5	240509
34 11 1 158 692	13.0441-4018.2	250083	34 21 1 103 683	24.0110-0110.1	410110	34 21 1 154 600	11.3331-8502.2	220005
34 11 1 159 249	13.0460-5032.2	605032	34 21 1 107 134	24.3215-1105.3	020159	34 21 1 154 600	24.3331-8502.5	240510
34 11 1 159 257	13.0460-9030.2	609030	34 21 1 111 515	13.2421-8005.2	210053	34 21 1 154 601	11.3331-8501.2	220004
34 11 1 159 261	13.0460-9031.2	609031	34 21 1 111 515	24.9242-8005.5	230027	34 21 1 154 601	24.3331-8501.5	240509
34 11 1 159 279	13.0460-6033.2	606033	34 21 1 111 516	13.2421-8006.2	210054	34 21 1 154 602	11.3331-8502.2	220005
34 11 1 159 415	13.0460-7046.2	607046	34 21 1 111 516	24.9242-8006.5	230028	34 21 1 154 602	24.3331-8502.5	240510
34 11 1 159 895	24.0130-0101.1	430101	34 21 1 111 852	03.0137-0009.2	650009	34 21 1 154 613	13.0460-7047.2	607047
34 11 1 159 896	24.0128-0101.1	428101	34 21 1 112 900	24.9242-8008.5	230030	34 21 1 154 871	11.3331-8501.2	220004
34 11 1 159 897	24.0122-0103.1	422103	34 21 1 112 961	03.0137-0009.2	650009	34 21 1 154 871	24.3331-8501.5	240509
34 11 1 159 897	24.0322-0103.1	522103	34 21 1 113 665	13.0460-0014.2	610014	34 21 1 154 872	11.3331-8502.2	220005
34 11 1 159 898	24.0112-0124.1	412124	34 21 1 113 666	13.0460-0125.2	610125	34 21 1 154 872	24.3331-8502.5	240510
34 11 1 159 916	24.0130-0101.1	430101	34 21 1 113 685	13.0460-0014.2	610014	34 21 1 154 921	03.0137-0152.2	650152
34 11 1 160 360	11.0230-0020.2	260023	34 21 1 116 949	24.0110-0110.1	410110	34 21 1 154 943	11.3331-8501.2	220004
34 11 1 160 361	11.3601-8501.2	220145	34 21 1 117 047	24.0225-0001.1	480043	34 21 1 154 943	24.3331-8501.5	240509
34 11 1 160 361	24.3601-8501.5	240533	34 21 1 117 104	03.3219-2106.3	020043	34 21 1 154 944	11.3331-8502.2	220005
34 11 1 160 362	24.3601-8502.5	240534	34 21 1 117 284	03.0137-0009.2	650009	34 21 1 154 944	24.3331-8502.5	240510
34 11 1 160 363	24.3601-8503.5	240535	34 21 1 117 730	24.0110-0147.1	410147	34 21 1 155 015	24.0110-0263.1	410263
34 11 1 160 364	24.3601-8504.5	240536	34 21 1 117 932	24.9242-8008.5	230030	34 21 1 155 077	13.0460-7047.2	607047
34 11 1 160 367	11.3601-8505.2	220149	34 21 1 117 981	13.0460-3024.2	603024	34 21 1 155 491	11.3331-8501.2	220018
34 11 1 160 367	24.3601-8505.5	240537	34 21 1 117 983	13.0460-0125.2	610125	34 21 1 155 501	24.0120-0113.1	420113
34 11 1 160 368	24.3601-8506.5	240538	34 21 1 119 182	13.0441-3303.2	250043	34 21 1 155 993	11.3331-8501.2	220004
34 11 1 160 450	13.0460-6033.2	606033	34 21 1 119 211	24.9242-8007.5	230029	34 21 1 155 993	24.3331-8501.5	240509
34 11 1 160 522	13.0460-2921.2	602921	34 21 1 119 212	24.9242-8008.5	230030	34 21 1 155 994	11.3331-8502.2	220005
34 11 1 160 708	13.0460-9037.2	609037	34 21 1 119 213	24.9242-8007.5	230029	34 21 1 155 994	24.3331-8502.5	240510
34 11 1 160 915	24.0122-0122.1	422122	34 21 1 119 566	24.0110-0110.1	410110	34 21 1 156 087	11.3381-8501.2	220018
34 11 1 160 915	24.0322-0122.1	522122	34 21 1 119 581	24.0110-0150.1	410150	34 21 1 156 167	24.3222-1604.3	020276
34 11 1 160 936	24.0122-0103.1	422103	34 21 1 119 581	24.0310-0150.1	510150	34 21 1 156 297	24.0222-8009.1	480026
34 11 1 160 936	24.0322-0103.1	522103	34 21 1 119 945	24.3220-1712.3	020406	34 21 1 156 463	13.0460-7047.2	607047



Vergleichsliste

Cross reference list - Tabella di conversione codici

Liste des correspondances - Lista referencias



BMW		BMW		BMW				
34 21 1 156 668	24.0110-0117.1	410117	34 21 1 162 967	24.0120-0113.1	420113	34 31 1 150 229	03.2122-6912.3	010154
34 21 1 156 668	24.0310-0117.1	510117	34 21 1 162 968	24.0110-0174.1	410174	34 31 1 151 110	03.2120-1362.3	010087
34 21 1 156 744	13.0460-7036.2	607036	34 21 1 163 132	24.0110-0110.1	410110	34 31 1 151 850	03.2120-1362.3	010087
34 21 1 156 746	13.0460-7047.2	607047	34 21 1 163 138	24.0120-0113.1	420113	34 31 1 152 767	03.2122-7513.3	010155
34 21 1 156 748	13.0460-7047.2	607047	34 21 1 163 140	24.0110-0174.1	410174	34 31 1 153 019	03.2123-8711.3	010196
34 21 1 157 042	11.0441-3802.2	250009	34 21 1 163 145	24.0110-0263.1	410263	34 31 1 153 053	03.2123-8312.3	010193
34 21 1 157 046	11.8116-0066.1	390577	34 21 1 163 146	24.0110-0263.1	410263	34 31 1 153 916	03.2122-6911.3	010153
34 21 1 157 302	03.0137-0151.2	650151	34 21 1 163 150	24.0110-0176.1	410176	34 31 1 153 919	03.2123-8311.3	010192
34 21 1 157 334	13.0460-3803.2	603803	34 21 1 163 241	11.3331-8501.2	220004	34 31 1 154 070	03.2122-6911.3	010153
34 21 1 157 360	24.0112-0120.1	412120	34 21 1 163 241	24.3331-8501.5	240509	34 31 1 154 263	03.2020-0402.3	010001
34 21 1 157 514	13.0460-7047.2	607047	34 21 1 164 499	13.0460-3605.2	603605	34 31 1 154 398	13.0460-7036.2	607036
34 21 1 157 555	24.3381-8503.5	240515	34 21 1 164 499	13.0470-3605.2	LD3605	34 31 1 154 405	03.2120-2082.3	010107
34 21 1 157 556	11.3381-8504.2	220021	34 21 1 164 501	13.0460-3605.2	603605	34 31 1 154 918	03.2120-1802.3	010099
34 21 1 157 556	24.3381-8504.5	240516	34 21 1 164 501	13.0470-3605.2	LD3605	34 31 1 155 269	03.2122-7513.3	010155
34 21 1 157 557	24.3381-8503.5	240515	34 21 1 165 233	13.0460-3605.2	603605	34 31 1 155 270	03.2123-8711.3	010196
34 21 1 157 558	11.3381-8504.2	220021	34 21 1 165 233	13.0470-3605.2	LD3605	34 31 1 156 273	03.2020-0402.3	010001
34 21 1 157 558	24.3381-8504.5	240516	34 21 1 165 235	13.0460-3605.2	603605	34 31 1 156 643	03.2125-2802.3	010210
34 21 1 157 646	11.8116-0066.1	390577	34 21 1 165 235	13.0470-3605.2	LD3605	34 31 1 157 111	03.2125-3011.3	010211
34 21 1 157 781	24.0110-0118.1	410118	34 21 1 165 255	24.0110-0147.1	410147	34 31 1 157 206	03.2022-1201.3	010009
34 21 1 157 814	13.0460-3803.2	603803	34 21 1 165 257	24.0112-0120.1	412120	34 31 1 160 660	24.2125-1716.3	010663
34 21 1 157 915	11.3331-8501.2	220004	34 21 1 165 259	24.0110-0118.1	410118	34 31 1 160 868	03.2025-1211.3	010475
34 21 1 157 915	24.3331-8501.5	240509	34 21 1 165 265	24.0120-0181.1	420181	34 31 1 161 617	03.2125-3011.3	010211
34 21 1 157 916	11.3331-8502.2	220005	34 21 2 157 574	13.0460-3605.2	603605	34 31 1 161 861	03.2125-3011.3	010211
34 21 1 157 916	24.3331-8502.5	240510	34 21 2 157 574	13.0470-3605.2	LD3605	34 31 1 161 870	24.2125-1716.3	010663
34 21 1 157 925	13.0460-7047.2	607047	34 21 2 157 575	13.0460-3605.2	603605	34 31 2 225 257	03.2123-0242.3	010163
34 21 1 157 926	13.0460-7047.2	607047	34 21 2 157 575	13.0470-3605.2	LD3605	34 32 1 102 567	24.5201-0290.3	331401
34 21 1 158 221	13.0460-3803.2	603803	34 21 2 186 348	03.3215-0221.3	020013	34 32 1 103 873	03.3304-0700.1	390082
34 21 1 158 266	13.0460-3803.2	603803	34 21 2 225 229	24.8190-0215.2	620215	34 32 1 108 133	83.7704-0290.3	330826
34 21 1 158 268	13.0460-3803.2	603803	34 21 2 225 409	11.3381-8501.2	220018	34 32 1 108 134	83.7704-0200.3	330825
34 21 1 158 323	13.0460-7036.2	607036	34 21 2 225 446	11.3381-8501.2	220018	34 32 1 108 135	24.5201-0204.3	331400
34 21 1 158 556	24.0222-8009.1	480026	34 21 2 226 013	13.0460-7047.2	607047	34 32 1 109 322	03.3508-8802.3	310051
34 21 1 158 576	24.0110-0262.1	410262	34 21 2 226 730	24.0120-0181.1	420181	34 32 1 109 324	03.3508-8801.3	310050
34 21 1 158 578	11.0441-4002.2	250011	34 21 2 227 671	11.8116-0066.1	390577	34 32 1 112 399	03.3508-5851.3	310039
34 21 1 158 642	13.0460-3803.2	603803	34 21 2 227 672	11.8116-0296.1	390445	34 32 1 112 400	03.3508-5951.3	310041
34 21 1 158 712	24.0225-0001.1	480043	34 21 2 282 198	11.8116-0296.1	390445	34 32 1 112 402	03.3508-5959.3	310044
34 21 1 158 883	11.0441-3602.2	250008	34 21 3 060 060	03.3217-0301.3	020022	34 32 1 113 183	24.5201-0204.3	331400
34 21 1 158 912	13.0460-7036.2	607036	34 21 3 460 010	24.0220-0007.1	480015	34 32 1 113 184	24.5201-0290.3	331401
34 21 1 159 171	11.0441-3803.2	250010	34 21 3 460 120	24.3217-1707.3	020108	34 32 1 114 908	03.3508-8802.3	310051
34 21 1 159 265	13.0460-3024.2	603024	34 21 3 660 020	03.0137-0009.2	650009	34 32 1 115 694	24.5201-0290.3	331401
34 21 1 159 273	13.0460-7047.2	607047	34 21 3 660 123	03.3217-0602.3	020024	34 32 1 115 695	24.5201-0204.3	331400
34 21 1 159 588	03.0137-0009.2	650009	34 21 6 750 190	13.0460-3605.2	603605	34 32 1 115 697	83.7704-0200.3	330825
34 21 1 159 659	24.0120-0181.1	420181	34 21 6 750 190	13.0470-3605.2	LD3605	34 32 1 116 515	83.7704-0290.3	330826
34 21 1 160 198	13.0460-3803.2	603803	34 21 6 753 675	11.8116-0296.1	390445	34 32 1 152 274	83.6124-0422.3	330269
34 21 1 160 333	11.3361-8503.2	220016	34 21 6 755 407	24.0110-0150.1	410150	34 32 1 153 107	83.7704-0200.3	330825
34 21 1 160 333	24.3361-8503.5	240513	34 21 6 755 407	24.0310-0150.1	510150	34 32 1 153 109	83.6124-0422.3	330269
34 21 1 160 334	11.3361-8504.2	220017	34 21 6 761 238	13.0460-3605.2	603605	34 32 1 154 327	24.5102-0304.3	331407
34 21 1 160 334	24.3361-8504.5	240514	34 21 6 761 238	13.0470-3605.2	LD3605	34 32 1 154 398	13.0460-7036.2	607036
34 21 1 160 340	13.0460-3605.2	603605	34 21 6 761 239	13.0460-3605.2	603605	34 32 1 154 904	24.5102-0304.3	331407
34 21 1 160 340	13.0470-3605.2	LD3605	34 21 6 761 239	13.0470-3605.2	LD3605	34 32 1 156 157	24.5113-0423.3	331396
34 21 1 160 353	11.3381-8501.2	220018	34 21 6 761 241	13.0460-3605.2	603605	34 32 1 156 334	83.6124-0331.3	330267
34 21 1 160 381	24.3381-8503.5	240515	34 21 6 761 241	13.0470-3605.2	LD3605	34 32 1 156 978	03.2125-3011.3	010211
34 21 1 160 382	11.3381-8504.2	220021	34 21 6 761 253	13.0460-3803.2	603803	34 32 1 159 165	83.6104-0245.3	330525
34 21 1 160 382	24.3381-8504.5	240516	34 21 6 778 168	13.0460-3605.2	603605	34 32 1 159 878	24.5201-0204.3	331400
34 21 1 160 397	11.3331-8501.2	220004	34 21 6 778 168	13.0470-3605.2	LD3605	34 32 1 159 879	24.5201-0290.3	331401
34 21 1 160 397	24.3331-8501.5	240509	34 21 9 064 270	03.0137-0151.2	650151	34 32 1 159 881	83.7704-0200.3	330825
34 21 1 160 398	11.3331-8502.2	220005	34 21 9 064 271	03.0137-0152.2	650152	34 32 1 159 882	83.7704-0290.3	330826
34 21 1 160 398	24.3331-8502.5	240510	34 31 1 103 271	03.2123-7002.3	010187	34 32 1 159 887	83.6104-0245.3	330525
34 21 1 160 533	13.0460-3605.2	603605	34 31 1 103 742	03.2123-6802.3	010186	34 32 1 159 888	83.6124-0331.3	330267
34 21 1 160 533	13.0470-3605.2	LD3605	34 31 1 113 656	03.2120-3412.3	010121	34 32 1 159 889	83.6124-0422.3	330269
34 21 1 160 927	11.3401-8503.2	220030	34 31 1 114 234	03.2122-6202.3	010148	34 32 1 159 890	24.5102-0304.3	331407
34 21 1 160 927	24.3401-8503.5	240521	34 31 1 116 605	03.2122-6912.3	010154	34 32 1 159 891	24.5113-0423.3	331396
34 21 1 160 928	11.3401-8504.2	220031	34 31 1 117 208	03.2120-0622.3	010079	34 32 1 160 240	83.6204-0300.3	330548
34 21 1 160 928	24.3401-8504.5	240522	34 31 1 117 593	03.2123-6802.3	010186	34 32 1 160 428	83.6204-0300.3	330548
34 21 1 161 455	13.0460-3605.2	603605	34 31 1 117 594	03.2122-6202.3	010148	34 32 1 189 882	83.7704-0290.3	330826
34 21 1 161 455	13.0470-3605.2	LD3605	34 31 1 120 032	03.2120-0622.3	010079	34 32 1 235 736	24.5224-0330.3	331263
34 21 1 162 305	24.0110-0117.1	410117	34 31 1 120 217	03.2120-0562.3	010078	34 32 1 237 261	83.6104-0470.3	330253
34 21 1 162 305	24.0310-0117.1	510117	34 31 1 120 218	03.2120-0562.3	010078	34 32 4 051 524	83.7704-0200.3	330825
34 21 1 162 446	13.0460-3605.2	603605	34 31 1 120 478	03.2123-6802.3	010186	34 32 4 650 315	83.7704-0290.3	330826
34 21 1 162 446	13.0470-3605.2	LD3605	34 31 1 120 479	03.2122-6202.3	010148	34 33 1 116 365	03.6058-0501.3	320074
34 21 1 162 536	13.0460-3605.2	603605	34 31 1 120 832	03.2123-7002.3	010187	34 33 1 117 162	10.0144-4216.3	340013
34 21 1 162 536	13.0470-3605.2	LD3605	34 31 1 121 911	03.3304-1400.1	390088	34 33 1 117 397	10.0504-0113.3	340021



Vergleichsliste

Cross reference list - Tabella di conversione codici



Liste des correspondances - Lista referencias

BMW 			BÜSSING 			CITROEN 		
34 33 1 117 398	10.0515-0515.3	340024	90 810 520 377	03.3318-0800.2	390112	4242 25	03.0520-0519.3	690519
34 33 1 119 875	10.0144-4216.3	340013	90 810 522 203	03.3508-0401.3	310014	4242 29	03.0520-1619.3	691619
34 33 1 150 231	03.7760-0902.4	300088	90 810 522 204	03.3508-0501.3	310017	4246 N5	24.0116-0105.1	416105
34 33 1 150 918	10.0144-4234.3	340014	90 810 522 212	03.3509-0100.3	310057	4246 R5	24.0120-0133.1	420133
34 33 1 150 922	10.0522-4002.1	340028	90 810 522 426	83.6103-0320.3	330224	4246 R5	24.0320-0133.1	520133
34 33 1 151 110	03.2120-1362.3	010087	90 810 525 166	83.6103-0260.3	330221	4246 T3	24.0109-0121.2	409121
34 33 1 152 494	03.6045-0620.3	320040	90 810 525 170	83.6103-0320.3	330224	4246 T9	24.0122-0142.1	422142
34 33 1 152 825	10.0144-4216.3	340013	90 810 525 179	83.6103-0500.3	330230	4246 V0	24.0122-0142.1	422142
34 33 1 153 303	10.0504-0113.3	340021	90 810 526 180	83.6103-0500.3	330230	4246 W6	24.0120-0133.1	420133
34 33 1 154 024	03.7760-0902.4	300088	90 810 526 183	83.6103-0600.3	330233	4246 W6	24.0320-0133.1	520133
34 33 1 155 270	03.2123-8711.3	010196	90 810 618 186	03.3150-0101.3	010321	4247 22	24.0225-4002.1	480048
34 33 1 156 925	10.0144-4234.3	340014	90 810 826 105	83.6103-0260.3	330221	4247 24	24.0222-8017.1	480071
34 33 1 156 978	03.2125-3011.3	010211	90 810 826 113	83.6103-0320.3	330224	4247 32	24.0218-0016.1	480011
34 33 1 157 199	03.7760-0902.4	300088				4247 32	24.0218-0716.2	480203
34 33 1 157 210	10.0515-0515.3	340024	CHEVROLET			4247 33	24.0216-5001.1	480001
34 33 1 157 416	03.7760-0902.4	300088	11046948372	13.0460-7051.2	607051	4247 35	24.0216-5701.2	480212
34 33 1 159 749	10.0515-9002.3	340026	11046952012	13.0460-7052.2	607052	4247 35	24.0218-0020.1	480074
34 33 1 162 054	10.0515-0515.3	340024	15254670	11.8171-0008.1	990049	4247 42	24.0218-0720.2	480205
34 33 1 162 056	10.0515-9002.3	340026	90121445	24.0120-0115.1	420115	4247 42	24.0216-5001.1	480001
34 34 1 156 716	03.6055-0303.3	320064	90121445	24.0320-0115.1	520115	4247 43	24.0216-5701.2	480212
34 35 1 153 964	24.8190-0201.2	620201	90235420	03.3217-3512.3	020032	4247 43	24.0216-5001.1	480001
34 35 1 179 819	24.8190-0213.2	620213	90511111	24.0120-0115.1	420115	4247 44	24.0218-0720.2	480205
34 35 1 179 820	24.8190-0214.2	620214	95975171	24.3219-1767.3	020552	4247 44	24.0218-0200.1	480074
34 35 1 179 821	24.8190-0215.2	620215	96175281	24.0220-0001.2	480013	4249 76	24.0218-0720.2	480205
34 35 1 180 432	24.8190-0214.2	620214	96179110	24.0124-0115.1	424115	4249 97	24.0122-0147.1	422147
34 35 1 180 780	24.8190-0215.2	620215	96193089	24.3521-1701.5	240001	4249 F0	24.0122-0142.1	422142
34 35 1 180 781	24.8190-0214.2	620214	96193090	24.3521-1702.5	240002	4249 F0	24.0120-0133.1	420133
34 35 1 180 782	24.8190-0213.2	620213	96226977	11.9481-9871.2	220681	4251 28	24.0320-0133.1	520133
34 35 1 181 802	24.8190-0224.2	620224	96226978	11.9481-9872.2	220682	4251 29	13.0460-4066.2	604066
34 35 1 182 270	10.0522-4005.1	340029	96574718	24.3219-1767.3	020552	4251 37	13.0460-4911.2	604911
34 35 9 058 889	24.8190-0201.2	620201	NP1441	03.0137-0267.2	650267	4251 38	13.0460-3962.2	603962
34 41 0 005 254	03.0137-9062.2	669062	NP1464	03.0137-0267.2	650267	4251 39	13.0460-7088.2	607088
34 41 0 304 724	03.0137-9062.2	669062				4251 39	13.0460-7088.2	607088
34 41 0 410 825	03.0137-9062.2	669062	CHRYSLER			4251 47	13.0460-3962.2	603962
34 41 1 103 128	24.3727-0202.2	580202	0 4423 368	24.0124-0193.1	424193	4251 59	13.0460-4910.2	604910
34 41 1 114 215	24.3727-0201.2	580201	0 4423 812	13.0460-8009.2	608009	4251 70	13.0460-7088.2	607088
34 41 1 118 053	03.0137-0149.2	650149	0 4509 340	24.0124-0193.1	424193	4251 83	13.0460-4956.2	604956
34 41 1 120 189	24.3727-0206.2	580206	0 5098 065AA	24.0109-0114.1	409114	4253 88	13.0460-5958.2	605958
34 41 1 121 512	03.0137-0150.2	650150	0 5098 065AA	24.0309-0114.1	509114	4254 30	13.0460-5958.2	605958
34 41 1 150 784	24.3727-0220.2	580220	0 5098 066AA	24.0109-0114.1	409114	4308 11	03.0137-9188.2	669188
34 41 1 150 896	24.3727-0209.2	580209	0 5098 066AA	24.0309-0114.1	509114	4308 38	03.0137-9055.2	669055
34 41 1 152 689	24.3727-0220.2	580220	0 5143 633AA	13.0460-4047.2	604047	4308 40	03.0137-9228.2	669228
34 41 1 153 582	24.3727-0213.2	580213	0 5143 633AA	13.0470-4047.2	LD4047	4308 50	03.0137-9079.2	669079
34 41 1 154 244	24.3727-0219.2	580219	4423 368	24.0124-0193.1	424193	4308 52	03.0137-9169.2	669169
34 41 1 154 401	24.3727-0212.2	580212	4423 812	13.0460-8009.2	608009	4308 52	03.0137-9086.2	669086
34 41 1 154 681	24.3727-0212.2	580212	4509 340	24.0124-0193.1	424193	4308 55	03.0137-9220.2	669220
34 41 1 155 523	03.0137-0150.2	650150	5098 065AA	24.0109-0114.1	409114	4308 57	03.0137-9228.2	669228
34 41 1 156 356	24.3727-0220.2	580220	5098 065AA	24.0309-0114.1	509114	4308 58	03.0137-9158.2	669158
34 41 1 157 823	03.0137-0149.2	650149	5098 066AA	24.0109-0114.1	409114	4308 61	03.0137-9228.2	669228
34 41 1 158 423	24.3727-0213.2	580213	5098 066AA	24.0309-0114.1	509114	4400 83	24.3481-1609.7	220197
34 41 1 159 467	03.0137-0149.2	650149	5143 633AA	13.0460-4047.2	604047	4400 84	24.3481-1610.7	220198
34 41 1 159 468	03.0137-0150.2	650150	5143 633AA	13.0470-4047.2	LD4047	4400 G7	11.3481-9833.2	220561
34 41 1 160 116	24.3727-0212.2	580212				4400 G7	24.3481-9833.5	240479
34 41 1 160 729	03.0137-0248.2	650248	CITROEN			4400 G8	11.3481-9834.2	220562
34 41 1 160 924	03.0137-0248.2	650248	00 176 894 00	24.3222-1118.3	020315	4400 G8	24.3481-9834.5	240480
34 41 1 162 005	24.3727-0215.2	580215	17 689 400	24.3222-1118.3	020315	4400 J4	11.3481-9833.2	220561
34 41 6 761 289	03.0137-0248.2	650248	2150 55	24.3728-0515.2	590515	4400 J4	24.3481-9833.5	240479
34 41 6 761 294	03.0137-0150.2	650150	2150 Q3	24.3728-0315.2	590315	4400 J5	11.3481-9834.2	220562
34 41 6 851 438	03.0137-9701.2	669701	4241 5T	03.0520-2022.3	692022	4400 J5	24.3481-9834.5	240480
34 41 9 064 019	03.0137-9062.2	669062	4241 6A	03.0520-0519.3	690519	4400 T9	24.3431-1701.5	240437
34 41 9 064 266	03.0137-9058.2	669058	4241 6C	03.0520-1619.3	691619	4400 V0	24.3431-1702.5	240438
34 41 9 064 274	03.0137-9148.2	669148	4241 E7	03.0137-0195.2	650195	4401 63	24.3481-1615.5	240031
34 41 9 064 497	03.0137-9062.2	669062	4241 E8	03.0137-0196.2	650196	4401 64	24.3481-1616.5	240032
61 31 1 361 896	24.8190-0215.2	620215	4241 H8	03.0137-0330.2	650330	4402 70	24.3225-1101.3	020294
61 31 1 362 977	10.0522-4005.1	340029	4241 H9	03.0137-0269.2	650269	4402 81	24.3226-1101.3	020296
			4241 J6	03.0137-0196.2	650196	4402 86	24.3220-1607.3	020234
BÜSSING			4241 J9	03.0137-0196.2	650196	4402 87	24.3220-1608.3	020235
13 3102 2201	83.6123-0381.3	330262	4241 L3	03.0137-0196.2	650196	4402 90	24.3219-1603.3	020200
90 810 518 186	03.3150-0101.3	010321		03.0137-0196.2	650196	4402 91	24.3219-1604.3	020201
90 810 520 195	03.3508-0501.3	310017		03.0137-0196.2	650196	4402 93	24.3219-1609.3	020319

Vergleichsliste

Cross reference list - Tabella di conversione codici

Liste des correspondances - Lista referencias



CITROEN 		CITROEN 		CITROEN 				
4402 94	24.3219-1610.3	020320	91 517 694	24.0120-0131.1	420131	95 643 714	03.0137-0269.2	650269
4402 97	24.3220-1617.3	020244	91 517 695	24.0120-0132.1	420132	95 644 348	03.2119-3389.3	010057
4402 98	24.3220-1618.3	020245	91 517 695	24.0320-0132.1	520132	95 646 300	13.0460-4042.2	604042
4402 A0	24.3220-1615.3	020242	91 518 534	03.2119-3389.3	010057	95 647 733	13.0460-2825.2	602825
4402 A1	24.3220-1616.3	020243	91 518 535	03.2119-3389.3	010057	95 651 053	13.0460-0206.2	610206
4427 55	13.0460-0435.2	610435	91 518 816	24.5112-0325.3	330415	95 653 061	13.0460-4906.2	604906
4427 59	13.0460-0206.2	610206	94 04 308 348	03.0137-9055.2	669055	95 653 213	03.0137-0195.2	650195
4427 64	13.0460-0406.2	610406	94 04 308 508	03.0137-9169.2	669169	95 654 085	13.0460-4956.2	604956
4427 65	13.0460-0403.2	610403	94 04 402 708	24.3225-1101.3	020294	95 654 086	13.0460-3916.2	603916
4427 66	13.0460-0424.2	610424	94 04 402 868	24.3220-1607.3	020234	95 655 344	03.0137-0195.2	650195
4427 70	11.8116-0073.1	390498	94 04 402 878	24.3220-1608.3	020235	95 658 555	24.3481-1615.5	240031
4427 84	11.8116-0129.1	390591	94 04 601 858	03.2120-2031.3	010106	95 658 556	24.3481-1616.5	240032
4427 94	13.0460-0424.2	610424	94 04 601 978	03.2119-3389.3	010057	95 658 571	03.0137-9175.2	669175
4439 14	11.0101-5407.2	260011	94 78 267 980	24.0218-0016.1	480011	95 658 617	13.0460-4042.2	604042
4439 33	11.8171-0008.1	990049	94 78 267 980	24.0218-0716.2	480203	95 658 639	13.0460-3916.2	603916
4448 70	11.0441-4501.2	250015	95 027 199	24.0108-0107.1	408107	95 659 340	13.0460-3943.2	603943
4448 74	11.0441-4811.2	250024	95 030 547	24.0109-0121.2	409121	95 659 341	13.0460-3954.2	603954
4448 76	11.0441-3602.2	250008	95 493 191	24.2120-1502.3	010405	95 659 353	13.0460-2825.2	602825
4575 08	24.7718-7301.2	990024	95 493 193	24.2117-1501.3	010398	95 659 472	03.0137-9086.2	669086
4601 83	24.2122-0801.3	010373	95 494 208	24.2119-1705.3	010460	95 659 474	24.3220-1603.3	020230
4601 85	03.2120-2031.3	010106	95 494 973	24.5119-0435.3	330472	95 659 475	24.3220-1604.3	020231
4601 88	24.2122-0801.3	010373	95 496 106	24.3727-0310.2	580310	95 659 534	03.2120-2031.3	010106
4601 97	03.2119-3389.3	010057	95 496 746	24.3728-0304.2	590304	95 659 616	13.0460-3952.2	603952
4601 98	24.2122-1704.3	010423	95 534 349	13.0460-4910.2	604910	95 659 622	24.0218-0020.1	480074
4601 A2	03.2119-3389.3	010057	95 555 655	24.2120-1502.3	010405	95 659 622	24.0218-0720.2	480205
4601 H4	03.2120-2031.3	010106	95 565 564	13.0460-4911.2	604911	95 659 640	13.0460-3947.2	603947
4601 H8	03.2120-2031.3	010106	95 569 738	24.3220-1105.3	020216	95 659 641	13.0460-3916.2	603916
4745 H7	24.3727-0816.2	580816	95 569 739	24.3222-1102.3	020257	95 659 642	13.0460-4956.2	604956
4745 L2	24.3727-0310.2	580310	95 570 824	13.0460-4900.2	604900	95 659 661	03.0137-0211.2	650211
4745 N6	24.3727-0324.2	580324	95 570 825	13.0460-4900.2	604900	95 659 662	03.0137-9125.2	669125
4745 T4	24.3727-0816.2	580816	95 571 755	24.2117-1501.3	010398	95 659 671	03.0137-0196.2	650196
4806 24	24.5112-0362.3	330512	95 571 759	24.2117-1501.3	010398	95 659 673	24.3219-1609.3	020319
4806 35	24.5112-0435.3	330524	95 575 080	24.0110-0183.1	410183	95 659 674	24.3219-1610.3	020320
4806 36	24.5112-0436.3	330574	95 582 061	24.0107-0105.2	407105	95 659 676	03.0137-0197.2	650197
4806 52	24.5112-0155.3	330507	95 582 062	24.0107-0105.2	407105	95 661 746	24.0110-0183.1	410183
4806 55	24.5111-0330.3	330160	95 589 273	13.0460-3915.2	603915	95 661 747	24.0120-0132.1	420132
4806 56	24.5111-0290.3	330108	95 590 838	13.0460-0403.2	610403	95 661 747	24.0320-0132.1	520132
4806 61	24.5229-0199.3	330534	95 594 172	24.6512-1507.3	320023	95 661 748	24.0110-0187.1	410187
4806 68	24.5111-0301.3	330499	95 599 101	24.5228-0200.3	330470	95 661 796	24.0112-0136.2	412136
4806 81	24.5111-0301.3	330499	95 599 322	24.0107-0100.1	407100	95 661 798	13.0460-4911.2	604911
4806 86	24.5229-0255.3	330581	95 606 669	24.3222-1118.3	020315	95 661 810	24.0108-0107.1	408107
4806 C4	83.6401-0159.3	330746	95 607 096	24.3481-1609.7	220197	95 661 812	24.0122-0141.1	422141
4816 26	24.5228-0185.3	330107	95 607 097	24.3481-1610.7	220198	95 661 813	24.0126-0100.1	426100
4816 27	24.5112-0260.3	330577	95 608 853	24.3219-1603.3	020200	95 661 814	24.0109-0121.2	409121
4816 31	24.5112-0285.3	330604	95 608 854	24.3219-1604.3	020201	95 661 849	24.0107-0105.2	407105
4816 35	24.5112-0285.3	330604	95 610 161	24.3727-0324.2	580324	95 661 851	03.0137-0330.2	650330
4816 36	24.5112-0315.3	330509	95 610 218	24.3728-0304.2	590304	95 661 871	13.0460-2825.2	602825
4834 76	24.3727-0527.2	580527	95 611 505	24.3727-0310.2	580310	95 663 080	03.0137-0092.2	650092
4861 32	24.6513-1701.3	320160	95 614 553	03.0137-9188.2	669188	95 666 970	13.0460-3952.2	603952
4861 98	24.6512-1507.3	320023	95 614 560	13.0460-0406.2	610406	95 666 971	13.0460-3954.2	603954
5 429 669 S	24.0120-0108.1	420108	95 616 818	13.0460-2956.2	602956	95 666 972	13.0460-3916.2	603916
5 462 429	13.0460-4911.2	604911	95 619 206	24.0216-5001.1	480001	95 666 973	13.0460-4956.2	604956
5 488 527	24.3217-1101.3	020309	95 619 206	24.0216-5701.2	480212	95 667 764	13.0460-2901.2	602901
5 950 690	24.5112-0285.3	330604	95 619 515	03.0137-0195.2	650195	95 667 765	13.0460-2902.2	602902
75 386 82	24.0116-0106.1	416106	95 619 516	03.0137-9079.2	669079	95 667 788	13.0460-4956.2	604956
75 485 825	24.0109-0108.1	409108	95 619 550	13.0460-4042.2	604042	95 667 809	24.0120-0133.1	420133
75 492 063	83.6196-0325.3	330727	95 619 603	13.0460-0424.2	610424	95 667 809	24.0320-0133.1	520133
75 492 434	24.3228-1101.3	020297	95 619 604	11.0441-4501.2	250015	95 667 810	24.0122-0142.1	422142
75 516 219	13.0460-4906.2	604906	95 624 482	13.0460-4911.2	604911	95 668 067	24.3220-1617.3	020244
75 516 220	13.0460-4906.2	604906	95 624 483	13.0460-4900.2	604900	95 668 068	24.3220-1618.3	020245
75 529 364	24.0120-0108.1	420108	95 624 484	13.0460-3915.2	603915	95 668 069	24.3220-1615.3	020242
75 530 008	24.3228-1102.3	020347	95 624 920	24.3481-1609.7	220197	95 668 070	24.3220-1616.3	020243
75 685 01	24.0113-0168.1	413168	95 624 921	24.3481-1610.7	220198	96 026 873	24.3727-0308.2	580308
79 01 440 250	24.3222-1102.3	020257	95 624 970	13.0460-2901.2	602901	96 026 875	24.3727-0309.2	580309
79 10 030 170	24.3220-1105.3	020216	95 625 020	03.0137-0285.2	650285	96 037 346	24.5411-0550.3	330567
79 10 034 452	03.6043-0201.3	320026	95 632 048	24.0120-0133.1	420133	96 054 779	24.0122-0141.1	422141
9 940 558	24.3226-1101.3	020296	95 632 048	24.0320-0133.1	520133	96 070 525	24.0110-0187.1	410187
91 500 635	24.5228-0185.3	330107	95 632 790	24.5120-0435.3	330488	96 075 716	24.5112-0155.3	330507
91 508 338	24.0110-0187.1	410187	95 637 322	24.0122-0141.1	422141	96 075 932	24.2122-1704.3	010423
91 509 908	24.0222-8017.1	480071	95 640 895	13.0460-2902.2	602902	96 080 322	24.5111-0290.3	330108
91 510 533	03.2120-2031.3	010106	95 643 713	03.0137-0330.2	650330	96 099 616	24.0126-0100.1	426100



Vergleichsliste

Cross reference list - Tabella di conversione codici



Liste des correspondances - Lista referencias

CITROEN 			DAEWOO 			DAIMLER 		
96 169 410	24.5228-0185.3	330107	90443261	24.3219-1767.3	020552	JLM 1829	13.0460-7138.2	607138
AM 451 018 A	03.0137-0092.2	650092	90498300	24.3219-1715.3	020122			
AM 451 23	24.0107-0100.1	407100	96175281	24.0220-0001.2	480013	FERRARI		
AMN 453 05	24.3215-1602.3	020355	96179110	24.0124-0115.1	424115			
AYA 453 011 A	24.3228-1101.3	020297	96179110	24.0324-0115.1	524115	101393	83.6215-0400.3	330323
E169002	24.0120-0133.1	420133	96192182	11.9481-9871.2	220681	116373	24.5224-0330.3	331263
ZF 00 791 462	24.6513-1701.3	320160	96192183	11.9481-9872.2	220682	118100	83.6101-0325.3	330206
ZF 04 449 694	24.0225-4002.1	480048	96193089	24.3521-1701.5	240001	127838	83.6101-0240.3	330202
ZF 04 450 938	24.3727-0527.2	580527	96193090	24.3521-1702.5	240002	95691531	13.0441-4009.2	250077
ZF 04 460 471	24.3728-0515.2	590515	96226977	11.9481-9871.2	220681			
ZF 04 477 793	24.5112-0260.3	330577	96226978	11.9481-9872.2	220682	FIAT		
ZF 05 952 297	24.5112-0362.3	330512	96430417	03.0137-0267.2	650267			
ZF 07 567 861	24.5112-0436.3	330574	96574718	24.3219-1767.3	020552	1313675080	24.0225-4002.1	480048
ZF 07 567 862	24.5112-0435.3	330524	NP1441	03.0137-0267.2	650267	1472155080	24.5111-0301.3	330499
ZF 07 568 440	24.0116-0105.1	416105	NP1464	03.0137-0267.2	650267	16420.26100.01/00	24.0110-0190.1	410190
ZF 07 568 501	24.0113-0168.1	413168	S4520005	03.0137-0267.2	650267	4108899	24.5105-0139.3	331216
ZF 07 570 315	24.5112-0260.3	330577	S4520006	03.0137-0267.2	650267	4121616	24.3219-0801.3	020181
ZF 07 570 316	24.5112-0285.3	330604				4121621	24.3222-0801.3	020248
ZF 09 937 665	24.2122-0801.3	010373	DAF			4139481	24.3219-0802.3	020182
ZF 09 938 829	24.2122-0801.3	010373	105 902	03.3508-8302.3	310046	4139486	24.3219-0802.3	020182
ZF 09 938 868	24.3225-1101.3	020294	110 634	24.5170-0315.3	331309	4139496	24.3219-0802.3	020182
ZF 93 500 520	24.0116-0105.1	416105	186 082	03.3318-0800.2	390112	4167824	24.5207-0205.3	330042
ZF 93 500 521	24.0116-0106.1	416106	502 808	13.0460-3010.2	603010	4167825	24.5207-0205.3	330042
			532 221	03.0370-1038.2	051038	4208311	24.0111-0130.1	411130
DACIA			532 221	03.0370-9998.2	059998	4213025	24.5209-0280.3	330044
41 06 021 92R	13.0460-2834.2	602834	562 327	03.0370-1131.2	051131	4234923	24.5105-0139.3	331216
60 01 547 616	24.3481-1611.5	240029	571 754	03.3138-2001.3	010310	4253987	24.5209-0280.3	330044
60 01 547 617	24.3481-1612.5	240030	573 788	03.3508-0501.3	310017	4256246	24.5209-0250.3	330043
60 01 547 619	13.0460-2834.2	602834	892 112	83.6104-0220.3	330474	4257052	24.5209-0250.3	330043
60 01 547 684	24.0112-0116.1	412116	892 402	03.3217-0401.3	020023	4270732	24.5209-0280.3	330044
60 01 547 703	24.0220-3021.1	480127	893 596	03.3508-8302.3	310046	4277188	24.3215-0802.3	020308
60 01 547 816	24.5111-0300.3	330407				4293206	24.5209-0353.3	330046
60 01 547 819	24.5111-0300.3	330407	DAIHATSU			4298756	24.3223-0801.3	020316
60 01 547 820	24.5229-0285.3	330032	04491-60020-000	13.0460-5816.2	605816	4348052	24.5209-0280.3	330044
60 01 547 911	13.0460-2834.2	602834	04491-60060-000	13.0460-5816.2	605816	4373614	24.3219-0801.3	020181
60 01 548 126	24.0218-0032.1	480118	04491-87602-000	13.0460-5816.2	605816	4374057	24.3219-0802.3	020182
60 01 548 578	24.0121-0106.1	421106	04491-87603-000	13.0460-5816.2	605816	4374063	24.3222-0801.3	020248
60 01 549 211	24.0112-0116.1	412116	04491-87606-000	13.0460-5816.2	605816	4377102	24.0111-0129.1	411129
60 01 551 097	24.5229-0285.3	330032	04491-87609-000	13.0460-5816.2	605816	4379680	24.0218-5001.1	480012
60 01 551 098	24.5111-0300.3	330407	04491-87609-000	13.0460-5816.2	605816	4385812	24.0111-0130.1	411130
77 00 419 824	24.0218-0032.1	480118	04492-87101-000	13.0460-5972.2	605972	4394460	24.3219-0801.3	020181
77 00 419 824	24.0218-0732.2	480207	04492-87102-000	13.0460-5972.2	605972	4394469	24.3223-0802.3	020286
77 00 839 322	24.0220-3021.1	480127	04492-87707-000	13.0460-5824.2	605824	4394597	24.2119-0815.3	010347
77 01 201 769	24.3481-1611.5	240029	04492-87708-000	13.0460-5824.2	605824	4397019	24.2119-0806.3	010345
77 01 201 770	24.3481-1612.5	240030	04495-87601-000	03.0137-0316.2	650316	4406021	24.3727-0503.2	580503
77 01 205 518	03.0137-9228.2	669228	04495-87603-000	03.0137-0316.2	650316	4410503	24.2119-0806.3	010345
77 01 206 339	24.0121-0106.1	421106	04495-87605-000	03.0137-0316.2	650316	4423942	13.0460-3936.2	603936
77 01 208 265	13.0460-2834.2	602834	04495-87606-000	03.0137-0316.2	650316	4434816	24.0112-0112.1	412112
77 01 209 639	13.0460-2834.2	602834	04495-87706-000	03.0137-0186.2	650186	4448411	24.0225-4002.1	480048
77 01 210 142	13.0460-2834.2	602834	04495-87707-000	03.0137-0315.2	650315	4449694	24.0113-0168.1	413168
77 11 130 071	13.0460-2834.2	602834	04495-87708-000	03.0137-0315.2	650315	4450938	24.3727-0527.2	580527
			04495-87712-000	03.0137-0186.2	650186	4464149	24.5209-0280.3	330044
			43512-87215-000	24.0116-0127.1	416127	4471492	24.5209-0280.3	330044
			43512-87216-000	24.0110-0235.1	410235	46401730	24.3727-0521.2	580521
			43512-87221-000	24.0110-0235.1	410235	46403088	24.0122-0147.1	422147
			43512-87509-000	24.0110-0235.1	410235	46403958	24.0122-0107.1	422107
			43512-87604-000	24.0118-0121.1	418121	46403959	24.0122-0147.1	422147
			43512-87605-000	24.0118-0121.1	418121	46403960	24.0111-0119.1	411119
			43512-87608-000	24.0118-0121.1	418121	46408830	24.3727-0545.2	580545
			43512-87709-000	24.0111-0139.1	411139	46416712	24.0120-0142.1	420142
			43512-87710-000	24.0118-0126.1	418126	46416712	24.0320-0142.1	520142
			43512-87717-000	24.0111-0139.1	411139	46421938	03.2525-2201.3	040026
			43512-87718-000	24.0118-0126.1	418126	46421939	24.2523-1702.3	040087
			43512-87725-000	24.0118-0126.1	418126	46423415	24.0120-0142.1	420142
			43512-87727-000	24.0111-0139.1	411139	46423415	24.0320-0142.1	520142
						46427947	24.0122-0107.1	422107
			DAIMLER			46427949	24.0122-0107.1	422107
			DBC 6595	24.8190-1302.2	621302	46445005	24.0122-0130.1	422130
			JLM 1305	24.0123-0108.1	423108	46445006	24.0122-0145.1	422145
						46448168	24.0122-0147.1	422147

Vergleichsliste

Cross reference list - Tabella di conversione codici

Liste des correspondances - Lista referencias



FIAT		FIAT		FIAT				
46455892	24.0122-0147.1	422147	60501237	03.2419-8000.3	030017	60743563	13.0460-2980.2	602980
46456849	24.3727-0521.2	580521	60501338	83.7704-0281.3	330804	60743565	13.0460-2962.2	602962
46531636	03.2525-2201.3	040026	60501453	24.0113-0171.1	413171	60743578	13.0460-2962.2	602962
46758714	24.0122-0147.1	422147	60501727	83.7704-0281.3	330804	60748478	03.2119-6207.3	010060
46758715	24.0110-0190.1	410190	60502664	03.2419-8000.3	030017	60749601	03.2119-6207.3	010060
46786435	83.6401-0159.3	330746	60502665	03.2525-2201.3	040026	60750205	24.3217-1112.3	020175
46819776	24.0218-0011.1	480006	60502666	03.2525-2201.3	040026	60750208	03.0137-9125.2	669125
46820655	24.0112-0127.1	412127	60511528	24.2523-1702.3	040087	60750413	13.0460-2969.2	602969
46831042	24.0110-0190.1	410190	60514881	24.0122-0128.1	422128	60750464	13.0460-3905.2	603905
51749124	24.0120-0142.1	420142	60516270	03.2525-1802.3	040025	60750465	13.0460-7055.2	607055
51749124	24.0320-0142.1	520142	60516271	03.2525-1802.3	040025	60750466	03.0137-0262.2	650262
51816526	24.0222-8018.1	480078	60516371	24.0113-0102.2	413102	60750467	03.0137-0139.2	650139
51859075	24.0112-0127.1	412127	60516390	03.6048-0601.3	320052	60750472	03.0137-0262.2	650262
51859078	24.0111-0119.1	411119	60516551	03.0137-0149.2	650149	60750509	13.0441-4212.2	250089
51863510	24.0218-0011.1	480006	60516944	03.0137-0149.2	650149	60750511	13.0441-3302.2	250042
51866264	24.0112-0127.1	412127	60516948	24.0109-0101.1	409101	60750780	13.0460-3905.2	603905
51866265	24.0112-0127.1	412127	60517115	03.2417-0301.3	030004	60750795	13.0460-3905.2	603905
51876438	24.0111-0119.1	411119	60517201	03.2122-0142.3	010128	60750796	13.0460-7055.2	607055
51900803	24.0218-0011.1	480006	60518094	03.2419-8900.3	030024	60750838	13.0460-2969.2	602969
55701046	24.5228-0216.3	330908	60518194	03.2419-8900.3	030024	60750871	03.0137-0262.2	650262
5880891	03.0137-0015.2	650015	60518410	24.5307-0320.3	330703	60750873	13.0460-7055.2	607055
5881040	03.0137-0015.2	650015	60520463	03.0137-0149.2	650149	60751116	03.3558-0676.3	310077
5881214	03.0137-0015.2	650015	60522092	24.0122-0119.2	422119	60760092	13.0460-3014.2	603014
5882984	13.0460-5409.2	605409	60522155	03.3558-0676.3	310077	60760106	13.0460-2980.2	602980
5882985	13.0460-5410.2	605410	60526121	24.0110-0166.1	410166	60760116	24.3384-1608.5	240168
5888144	03.0137-0015.2	650015	60533971	24.0110-0179.1	410179	60760117	03.2122-0142.3	010128
5888146	03.0137-0330.2	650330	60559851	24.3727-0003.2	580003	60760120	13.0460-2962.2	602962
5888147	13.0460-2941.2	602941	60569163	24.0122-0145.1	422145	60760121	13.0460-2809.2	602809
5888149	13.0460-3936.2	603936	60569164	24.0110-0209.1	410209	60760124	13.0460-2980.2	602980
5888154	13.0460-3936.2	603936	60571548	24.0122-0145.1	422145	60765018	13.0460-2968.2	602968
5888433	03.0137-0207.2	650207	60576335	24.0111-0149.1	411149	60776098	13.0460-2968.2	602968
5888453	03.0137-0208.2	650208	60577826	24.3727-0006.2	580006	60777262	13.0460-3905.2	603905
5888528	13.0460-5409.2	605409	60578093	24.0122-0145.1	422145	60777263	13.0460-7055.2	607055
5888529	13.0460-5410.2	605410	60580072	24.3727-0003.2	580003	60777264	13.0460-2969.2	602969
5888781	13.0460-2948.2	602948	60622077	24.0122-0145.1	422145	60777600	13.0460-2949.2	602949
5888939	13.0460-3904.2	603904	60653478	24.0122-0145.1	422145	60777601	13.0460-2951.2	602951
5889089	13.0460-2949.2	602949	60653479	24.0110-0209.1	410209	60777621	13.0460-2979.2	602979
5890500	03.0137-0207.2	650207	60658565	24.0122-0145.1	422145	60777805	13.0460-9034.2	609034
5890763	03.0137-0015.2	650015	60658566	24.0110-0209.1	410209	60778257	13.0460-4019.2	604019
5892309	13.0460-3939.2	603939	60699518	24.0122-0145.1	422145	60778260	13.0460-3011.2	603011
5892310	13.0460-3940.2	603940	60701786	24.0110-0166.1	410166	60778263	13.0460-4035.2	604035
5892313	13.0460-2952.2	602952	60702072	24.0110-0179.1	410179	60778265	13.0460-3013.2	603013
5892330	13.0460-2948.2	602948	60703319	03.0137-0262.2	650262	60778279	13.0460-3905.2	603905
5892481	13.0460-2949.2	602949	60709427	83.7704-0281.3	330804	60778285	13.0460-7055.2	607055
5892593	13.0460-3904.2	603904	60709762	83.7704-0281.3	330804	60778676	13.0460-2968.2	602968
5892601	13.0460-2941.2	602941	60711956	13.0441-4819.2	250104	60800249	03.2122-0142.3	010128
5892650	13.0460-2962.2	602962	60712016	13.0441-3001.2	250041	60800345	24.0111-0149.1	411149
5892727	13.0460-2949.2	602949	60712608	13.0460-3011.2	603011	60801754	24.0120-0129.1	420129
5892728	13.0460-2949.2	602949	60713601	13.0460-6027.2	606027	60801755	24.0110-0190.1	410190
5892730	13.0460-2949.2	602949	60714325	03.0450-2509.2	082509	60801786	24.0110-0209.1	410209
5892731	13.0460-2952.2	602952	60714401	13.0441-3803.2	250060	60801787	24.0110-0209.1	410209
5892732	13.0460-2949.2	602949	60714404	13.0460-3011.2	603011	60805117	24.0111-0149.1	411149
5892733	13.0460-2949.2	602949	60714480	03.2120-4504.3	010123	60805172	24.0122-0130.1	422130
5892734	13.0460-2949.2	602949	60716270	03.2525-1802.3	040025	60806135	24.0122-0147.1	422147
5892735	13.0460-2949.2	602949	60718544	83.7704-0281.3	330804	60806137	24.0120-0142.1	420142
5892740	13.0460-4958.2	604958	60720645	13.0460-4019.2	604019	60806137	24.0320-0142.1	520142
5944002	24.5228-0200.3	330470	60720648	13.0460-3013.2	603013	60806307	24.3727-0521.2	580521
5950690	24.5112-0285.3	330604	60723584	13.0460-6027.2	606027	60806310	24.3727-0006.2	580006
5951339	24.3727-0507.2	580507	60723585	13.0460-3011.2	603011	60806311	24.3727-0521.2	580521
5951342	24.3727-0508.2	580508	60727286	13.0460-4035.2	604035	60807625	24.0122-0130.1	422130
5951660	13.0460-3939.2	603939	60727290	13.0460-3011.2	603011	60808872	24.0112-0127.1	412127
5951671	13.0460-3940.2	603940	60729251	13.0460-4035.2	604035	60809894	24.0116-0105.1	416105
5951897	13.0460-3936.2	603936	60729279	13.0460-3011.2	603011	60809966	24.3220-1116.3	020313
5952297	24.5112-0362.3	330512	60729341	03.2122-0142.3	010128	60810025	24.0222-8018.1	480078
5961814	24.0112-0122.1	412122	60730497	03.2419-8601.3	030022	60810038	03.0137-0208.2	650208
5969735	24.3727-0517.2	580517	60733549	13.0441-4212.2	250089	60810076	24.0120-0142.1	420142
5971061	24.5112-0410.3	330494	60737389	13.0460-9034.2	609034	60810076	24.0320-0142.1	520142
5974792	24.0218-5001.1	480012	60740842	13.0460-4019.2	604019	60810227	24.0120-0129.1	420129
5983950	13.0460-2941.2	602941	60740845	13.0460-3013.2	603013	60810239	13.0460-2949.2	602949
5987896	24.3219-1103.3	020408	60741656	03.3558-0676.3	310077	60810404	24.0122-0147.1	422147
60501235	03.2419-8000.3	030017	60743417	13.0460-2980.2	602980	60811256	24.0120-0142.1	420142



Vergleichsliste

Cross reference list - Tabella di conversione codici

Liste des correspondances - Lista referencias



FIAT		FIAT		FIAT				
60811256	24.0320-0142.1	520142	7655155	24.5112-0360.3	330513	792895	24.2120-0801.3	010362
60811266	24.0120-0142.1	420142	7655156	24.5112-0384.3	330651	792987	24.2119-0806.3	010345
60811266	24.0320-0142.1	520142	7661241	24.3727-0507.2	580507	792999	24.2119-0826.3	010349
60811879	24.0111-0119.1	411119	7663465	24.0111-0119.1	411119	793010	24.2119-0826.3	010349
60811890	24.0122-0107.1	422107	7663466	24.0112-0127.1	412127	793034	24.2119-0827.3	010350
60812067	24.0122-0107.1	422107	7667806	24.5228-0223.3	330530	793039	24.2119-0827.3	010350
60812137	24.0122-0107.1	422107	7670999	24.3728-0502.2	590502	793053	24.2119-0827.3	010350
60812422	24.0122-0147.1	422147	7671309	24.3727-0518.2	580518	793120	13.0460-2948.2	602948
60812546	24.3727-0521.2	580521	7671310	24.3727-0509.2	580509	793184	13.0460-2949.2	602949
60812799	24.3727-0006.2	580006	7674443	24.3728-0503.2	590503	793193	24.2119-0806.3	010345
60813038	24.0122-0147.1	422147	7685656	24.0111-0119.1	411119	793234	24.2119-0829.3	010351
60813056	24.3727-0521.2	580521	7696710	24.3219-0803.3	020183	793266	24.2120-1710.3	010468
60814839	24.0222-8018.1	480078	7710210	24.3728-0503.2	590503	793272	13.0460-3942.2	603942
60815246	03.2525-2201.3	040026	7710212	24.3728-0502.2	590502	793307	24.2119-0806.3	010345
7032156	03.2122-0142.3	010128	7714822	24.3727-0521.2	580521	793309	24.2119-0815.3	010347
7074619	24.2120-0802.3	010363	7722749	24.3728-0503.2	590503	793322	13.0460-3940.2	603940
71736960	83.6401-0159.3	330746	7722751	24.3728-0502.2	590502	793323	13.0460-3940.2	603940
71737950	24.3220-1116.3	020313	7724708	24.3728-0515.2	590515	793325	13.0460-3939.2	603939
71737951	24.3220-1116.3	020313	77362187	13.0460-2962.2	602962	793330	13.0460-2941.2	602941
71738145	24.0120-0142.1	420142	77362266	13.0460-3939.2	603939	793355	13.0460-2941.2	602941
71738145	24.0320-0142.1	520142	77362292	03.0137-0015.2	650015	793438	24.3215-1102.3	020156
71738324	24.3219-0803.3	020183	77362298	03.0137-0208.2	650208	793439	24.3219-1102.3	020190
71738375	03.0137-0015.2	650015	77362317	03.0137-0207.2	650207	793460	13.0460-2949.2	602949
71738376	03.0137-0207.2	650207	77362318	03.0137-0015.2	650015	793470	13.0460-2941.2	602941
71738421	24.0111-0119.1	411119	77362423	03.0137-0015.2	650015	793485	13.0460-3942.2	603942
71738423	24.0112-0122.1	412122	77362424	03.0137-0015.2	650015	793774	13.0460-2952.2	602952
71738912	24.0110-0209.1	410209	77362425	03.0137-0207.2	650207	794079	13.0460-2948.2	602948
71738913	24.0110-0190.1	410190	77362611	03.0137-9088.2	669088	794091	13.0460-2949.2	602949
71739132	24.3225-1101.3	020294	77363591	11.8171-0008.1	990049	794858	13.0460-2949.2	602949
71739567	24.0122-0145.1	422145	7740758	24.3222-1701.3	020376	794870	13.0460-2948.2	602948
71739568	24.0122-0145.1	422145	7750119	24.0218-0011.1	480006	82388579	24.0120-0129.1	420129
71748384	13.0460-3939.2	603939	7757604	24.3220-1116.3	020313	82390671	24.3727-0514.2	580514
71750931	13.0460-5929.2	605929	7769850	24.0222-8018.1	480078	82394418	24.0110-0190.1	410190
71752994	13.0460-2949.2	602949	7777842	24.0218-5001.1	480012	82401754	24.5209-0280.3	330044
71769481	24.0111-0119.1	411119	7779409	24.0120-0142.1	420142	82409600	03.2525-2201.3	040026
71770933	24.0111-0119.1	411119	7779409	24.0320-0142.1	520142	82422135	24.5209-0280.3	330044
71772238	24.0111-0119.1	411119	7784315	24.3728-0503.2	590503	82427592	24.0122-0145.1	422145
7531819	24.0116-0105.1	416105	7785747	24.3728-0502.2	590502	82433789	24.0122-0130.1	422130
7538682	24.0116-0106.1	416106	7789267	24.0110-0209.1	410209	82433858	24.0120-0129.1	420129
7550923	24.0120-0143.1	420143	790204	24.2119-0806.3	010345	82433859	24.0110-0190.1	410190
7563849	24.5112-0410.3	330494	790215	24.3219-0801.3	020181	82433860	24.0120-0129.1	420129
7563852	24.5228-0200.3	330470	790605	13.0460-3936.2	603936	82434070	24.0110-0190.1	410190
7567861	24.5112-0436.3	330574	790608	24.2119-0827.3	010350	82434169	24.0114-0102.1	414102
7567862	24.5112-0435.3	330524	790610	24.3217-1115.3	020310	82439939	24.0110-0209.1	410209
7568440	24.0116-0105.1	416105	790833	24.3219-0803.3	020183	82440275	24.0110-0209.1	410209
7568501	24.0113-0168.1	413168	790837	24.2119-0827.3	010350	82441688	24.3727-0514.2	580514
7569160	24.5112-0386.3	330516	790838	24.2119-0827.3	010350	82442878	24.5112-0220.3	330613
7569161	24.5112-0390.3	330517	790853	24.3223-0802.3	020286	82450539	24.0122-0145.1	422145
7569593	24.5112-0315.3	330509	790860	24.2119-0806.3	010345	82450657	24.0122-0147.1	422147
7569600	24.0222-8018.1	480078	790981	24.6046-0801.3	320116	82451441	24.0122-0130.1	422130
7570315	24.5112-0260.3	330577	791328	24.2119-0829.3	010351	82451747	24.0122-0130.1	422130
7570316	24.5112-0285.3	330604	791440	24.2119-0826.3	010349	82462136	24.0122-0107.1	422107
7573814	24.3727-0519.2	580519	791442	24.3481-1703.5	240051	82464702	24.0120-0129.1	420129
7592915	24.3728-0501.2	590501	791443	24.3481-1704.5	240052	82468102	24.5112-0384.3	330651
7599325	24.0218-0011.1	480006	791444	24.3481-1703.5	240051	82476515	24.0126-0114.1	426114
7607381	24.6513-0801.3	320117	791445	24.3481-1704.5	240052	82481842	24.3727-0545.2	580545
7609087	24.5112-0384.3	330651	791452	24.2119-0806.3	010345	92323733	24.3727-0510.2	580510
7609088	24.5112-0360.3	330513	791456	24.6513-0801.3	320117	92323734	24.3727-0511.2	580511
7609367	24.3727-0509.2	580509	791462	24.6513-1701.3	320160	92498609	24.0112-0127.1	412127
7610378	24.3728-0503.2	590503	791473	24.3541-1748.5	240222	93500520	24.0116-0105.1	416105
7615326	24.3727-0510.2	580510	791906	13.0460-3939.2	603939	93500521	24.0116-0106.1	416106
7615327	24.3727-0511.2	580511	792040	24.2120-0801.3	010362	9404427708	11.8116-0073.1	390498
7615339	24.3727-0513.2	580513	792088	24.2119-0826.3	010349	9404439148	11.0101-5407.2	260011
7615342	24.3727-0006.2	580006	792383	13.0460-3904.2	603904	9404448768	11.0441-3602.2	250008
7615343	24.3727-0521.2	580521	792489	13.0460-2941.2	602941	9937665	24.2122-0801.3	010373
7619751	24.5228-0223.3	330530	792539	13.0460-3939.2	603939	9938829	24.2122-0801.3	010373
7645056	24.0120-0142.1	420142	792561	13.0460-3940.2	603940	9938868	24.3225-1101.3	020294
7645056	24.0320-0142.1	520142	792589	13.0460-3939.2	603939	9939503	13.0460-2962.2	602962
7649509	24.3728-0502.2	590502	792698	13.0460-2941.2	602941	9939718	03.0137-0330.2	650330
7649589	24.5112-0315.3	330509	792703	13.0460-3904.2	603904	9940092	13.0460-2901.2	602901
7650707	24.0120-0143.1	420143	792725	13.0460-3940.2	603940	9940554	24.3225-1101.3	020294



Vergleichsliste

Cross reference list - Tabella di conversione codici

Liste des correspondances - Lista referencias



FIAT		FORD		FORD				
9940558	24.3226-1101.3	020296	0438874	83.7704-0421.3	330827	1044225	24.3364-1704.5	240310
9940969	13.0460-2962.2	602962	0461234	83.6204-0300.3	330548	1044227	24.3364-1704.5	240310
9941175	13.0460-2980.2	602980	0504992	83.6103-0320.3	330224	1044229	24.3364-1706.5	240312
9941207	13.0460-2901.2	602901	0553750	03.3217-0602.3	020024	1044230	24.3364-1706.5	240312
9941208	13.0460-2902.2	602902	0558087	03.3219-2106.3	020043	1044233	24.3364-1703.5	240309
9941210	03.0137-0269.2	650269	0609741	83.6103-0600.3	330233	1044234	24.3364-1703.5	240309
9941211	13.0460-2962.2	602962	0621258	83.6104-0450.3	330251	1044237	24.3364-1705.5	240311
9941243	03.0137-0330.2	650330	0690344	83.6123-0381.3	330262	1044239	24.3364-1705.5	240311
9941666	24.3344-1703.5	240117	0690345	83.6103-0240.3	330220	1045392	24.0218-0024.2	480079
9941667	24.3344-1704.5	240118	0690346	83.6103-0470.3	330229	1045392	24.0218-0724.2	480206
9941669	13.0460-2951.2	602951	0710084	13.0460-4035.2	604035	1046070	24.3727-0639.2	580639
9941872	13.0460-2979.2	602979	0710417	13.0460-4035.2	604035	1048069	24.3727-0641.2	580641
9941873	13.0460-2962.2	602962	0800962	13.0460-6027.2	606027	1048296	24.3541-1708.5	240068
9942014	24.3384-1608.5	240168	1000837	24.3727-0639.2	580639	1048298	24.3541-1707.5	240067
9942902	24.3344-1703.5	240117	1000839	24.3727-0641.2	580641	1048308	13.0460-3965.2	603965
9942903	24.3344-1704.5	240118	1000859	24.0218-0024.2	480079	1048309	13.0460-3965.2	603965
9942904	13.0460-2951.2	602951	1000859	24.0218-0724.2	480206	1050100	24.3727-0644.2	580644
9943323	24.2120-1733.3	010686	1001959	24.3384-1708.5	240172	1051343	24.3727-0644.2	580644
9943934	03.0137-0330.2	650330	1001960	24.3384-1707.5	240171	1054047	24.2419-1723.3	030112
9943935	03.0137-0269.2	650269	1002202	11.0441-5704.2	250034	1060213	24.3727-0639.2	580639
9944329	13.0460-2979.2	602979	1005567	24.3727-0639.2	580639	1063194	24.3727-0644.2	580644
9944386	24.2122-1716.3	010485	1005568	24.3727-0639.2	580639	1064762	13.0460-7073.2	607073
9944678	13.0460-2979.2	602979	1005574	24.3727-0641.2	580641	1064763	13.0460-7071.2	607071
9944784	24.3344-1704.5	240118	1006004	03.0137-9217.2	669217	1066271	24.0120-0147.1	420147
9944785	24.3344-1703.5	240117	1006005	03.0137-9177.2	669177	1066271	24.0320-0147.1	520147
9944814	13.0460-2809.2	602809	1006011	24.3220-1112.3	020223	1071938	83.7114-0376.3	330373
9944861	13.0460-2902.2	602902	1006012	24.3222-1117.3	020272	1071939	83.6362-0542.3	330485
9945070	13.0460-2901.2	602901	1006013	24.3217-1715.3	020463	1072951	24.3601-8528.5	240504
9945076	13.0460-2902.2	602902	1006016	24.3219-1107.3	020338	1072953	24.3601-8527.5	240503
9945371	03.0137-0273.2	650273	1007172	24.3727-0644.2	580644	1072959	24.3601-8528.5	240504
9945379	24.3219-0803.3	020183	1007814	11.3481-8514.2	220336	1072961	24.3601-8527.5	240503
9945496	13.0460-2951.2	602951	1007818	11.3541-8529.2	220341	1073731	13.0460-7057.2	607057
9945582	24.3344-1703.5	240117	1007818	24.3541-8529.5	240553	1073732	13.0460-7056.2	607056
9945584	24.3344-1704.5	240118	1007819	11.3541-8530.2	220342	1078043	24.3727-0639.2	580639
9945629	13.0460-2962.2	602962	1007819	24.3541-8530.5	240554	1079347	13.0460-7057.2	607057
9945762	24.2122-1716.3	010485	1007821	11.3481-8513.2	220335	1079348	13.0460-7056.2	607056
9945821	13.0460-2951.2	602951	1010502	13.0460-7073.2	607073	1079919	13.0460-7073.2	607073
9945822	13.0460-2951.2	602951	1010503	13.0460-7071.2	607071	1079920	13.0460-7071.2	607071
9945823	13.0460-2951.2	602951	1013581	24.0112-0141.1	412141	1086921	03.0137-9217.2	669217
9945911	24.3225-1101.3	020294	1013815	24.5303-0400.3	330404	1086922	03.0137-9177.2	669177
9945939	24.3226-1101.3	020296	1013843	13.0460-7073.2	607073	1088934	13.0460-3963.2	603963
9946227	13.0460-2979.2	602979	1014655	03.0137-0272.2	650272	1088938	13.0460-3964.2	603964
9946560	03.0137-0330.2	650330	1017668	24.0218-0024.2	480079	1092259	24.2419-1723.3	030112
9946561	03.0137-0269.2	650269	1017668	24.0218-0724.2	480206	1093543	24.3727-0639.2	580639
9946898	24.3481-1703.5	240051	1018615	24.5304-0280.3	330589	1095201	13.0460-7057.2	607057
9946899	24.3481-1704.5	240052	1019239	24.3727-0639.2	580639	1095202	13.0460-7056.2	607056
9947007	13.0460-2951.2	602951	1019240	24.3727-0641.2	580641	1096940	13.0460-7056.2	607056
9947017	24.3481-1703.5	240051	1019598	24.0112-0141.1	412141	1096942	13.0460-7057.2	607057
9947018	24.3481-1704.5	240052	1019604	24.0120-0147.1	420147	1097769	13.0460-7163.2	607163
9947098	24.2120-1710.3	010468	1019604	24.0320-0147.1	520147	1102560	24.0124-0113.1	424113
9947099	24.2122-1716.3	010485	1019627	24.2125-1706.3	010496	1103617	24.3727-0639.2	580639
9947106	03.0137-0262.2	650262	1019628	24.2125-1708.3	010498	1103618	24.3727-0644.2	580644
9947943	24.3220-1116.3	020313	1022077	13.0460-7165.2	607165	1104131	24.3217-1715.3	020463
9948200	03.0137-0207.2	650207	1022078	13.0460-7163.2	607163	1104132	24.3219-1107.3	020338
9948232	24.3219-0803.3	020183	1022079	13.0460-7056.2	607056	1106343	03.3517-5100.1	390326
9948235	03.0137-0015.2	650015	1022395	03.6043-1956.3	320202	1108004	24.3727-0641.2	580641
9948315	24.2122-1716.3	010485	1022421	03.6043-1953.3	320201	1111283	13.0460-2933.2	602933
9950437	24.3344-1703.5	240117	1022424	03.6043-1954.3	320226	1112542	24.0112-0141.1	412141
9950438	24.3344-1704.5	240118	1023692	83.6118-0281.3	330483	1113008	03.6043-1954.3	320226
9950477	24.3344-1703.5	240117	1025018	83.6362-0542.3	330485	1113010	03.6043-1956.3	320202
9950478	24.3344-1704.5	240118	1025911	24.0120-0146.1	420146	1113275	03.6043-1953.3	320201
9950479	13.0460-2951.2	602951	1025911	24.0320-0146.1	520146	1113641	24.3220-1111.3	020222
9950521	24.2122-1716.3	010485	1027371	24.0222-8014.1	480031	1113980	24.3222-1117.3	020272
9950713	13.0460-2951.2	602951	1027745	24.5302-0296.3	330476	1115986	24.3222-1114.3	020269
9950714	13.0460-2951.2	602951	1030601	13.0460-7073.2	607073	1118406	24.3364-1704.5	240310
9950814	03.0137-0262.2	650262	1031781	13.0460-3965.2	603965	1118407	24.3364-1706.5	240312
9950853	13.0460-2951.2	602951	1037718	24.2419-1723.3	030112	1118408	24.3364-1703.5	240309
9951116	24.2122-1716.3	010485	1038834	24.3727-0644.2	580644	1118409	24.3364-1705.5	240311
			1040745	24.3727-0641.2	580641	1121371	11.0230-0687.1	260106
			1041466	11.8116-0143.1	390513	1121374	11.3481-8512.2	220338
			1042688	13.0460-7071.2	607071	1121375	11.3481-8511.2	220337



Vergleichsliste



Cross reference list - Tabella di conversione codici

Liste des correspondances - Lista referencias

FORD		FORD		FORD				
1121377	11.3481-8514.2	220336	1514237	24.0110-0115.1	410115	1630011	24.0124-0109.1	424109
1121379	11.3481-8513.2	220335	1517558	24.3217-1715.3	020463	1630012	24.0110-0186.1	410186
1121380	11.3541-8530.2	220342	1517559	24.3219-1107.3	020338	1630149	24.0110-0115.1	410115
1121380	24.3541-8530.5	240554	1539549	24.0114-0100.1	414100	1630360	24.3217-1114.3	020177
1121381	11.3541-8529.2	220341	1540738	13.0460-7042.2	607042	1637322	24.3727-0624.2	580624
1121381	24.3541-8529.5	240553	1540739	13.0460-7042.2	607042	1637874	13.0441-4015.2	250080
1121753	24.3601-8528.5	240504	1540740	13.0460-7042.2	607042	1637904	24.0711-1129.1	360002
1121758	24.3601-8527.5	240503	1541801	24.0218-0011.1	480006	1637969	24.0110-0115.1	410115
1126532	24.3220-1112.3	020223	1541804	24.0111-0119.1	411119	1638880	13.0460-2928.2	602928
1129032	24.5305-0310.3	331326	1544173	24.0218-0011.1	480006	1642643	13.0460-6910.2	606910
1129985	13.0460-3963.2	603963	1548454	83.7704-0320.3	330851	1643706	24.0124-0113.1	424113
1129986	13.0460-3964.2	603964	1548635	13.0460-7042.2	607042	1643718	24.0124-0113.1	424113
1130751	13.0460-3965.2	603965	1549695	24.0113-0118.1	413118	1644433	24.3727-0616.2	580616
1130758	13.0460-7056.2	607056	1549699	24.0113-0122.1	413122	1644434	24.3727-0624.2	580624
1133442	24.3222-1117.3	020272	1552517	13.0441-5409.2	250112	1644831	24.0124-0151.1	424151
1133750	13.0460-3965.2	603965	1563516	03.2119-0525.3	010046	1644844	24.0124-0112.1	424112
1134158	13.0460-3960.2	603960	1563526	03.2120-5503.3	010124	1644845	24.0124-0112.1	424112
1134159	13.0460-3959.2	603959	1566369	13.0460-7042.2	607042	1644857	24.0110-0193.1	410193
1138582	11.3481-8512.2	220338	1568857	83.6104-0450.3	330251	1644859	24.0124-0113.1	424113
1138589	11.3481-8514.2	220336	1568862	83.7704-0320.3	330851	1647679	24.3728-0625.2	590625
1138590	11.3541-8530.2	220342	1571346	24.0110-0148.1	410148	1647730	13.0460-7040.2	607040
1138590	24.3541-8530.5	240554	1571347	24.0110-0148.1	410148	1647731	13.0460-7041.2	607041
1138591	24.3601-8528.5	240504	1571348	24.0110-0148.1	410148	1648236	13.0460-2928.2	602928
1138594	11.3481-8511.2	220337	1572058	13.0460-7042.2	607042	1648631	03.0137-0164.2	650164
1138600	11.3481-8513.2	220335	1574839	13.0460-7042.2	607042	1648810	83.6339-0228.3	330361
1138601	11.3541-8529.2	220341	1575877	24.0110-0148.1	410148	1648811	83.6339-0253.3	330362
1138601	24.3541-8529.5	240553	1576612	13.0460-7042.2	607042	1652206	13.0460-2928.2	602928
1138602	24.3601-8527.5	240503	1576821	13.0460-7042.2	607042	1652547	24.0110-0186.1	410186
1138611	24.3541-1708.5	240068	1576827	13.0460-7042.2	607042	1654620	13.0460-7041.2	607041
1138612	24.3541-1707.5	240067	1576829	13.0460-7042.2	607042	1656491	24.3727-0628.2	580628
1203934	03.0137-0376.2	650376	1576830	13.0460-7042.2	607042	1656793	24.3727-0624.2	580624
1204850	13.0460-3963.2	603963	1576835	13.0460-7042.2	607042	1659647	24.3727-0623.2	580623
1204852	13.0460-3964.2	603964	1576836	13.0460-7042.2	607042	1659671	24.3727-0623.2	580623
1320581	24.0120-0147.1	420147	1576887	13.0460-7042.2	607042	1659938	13.0460-7073.2	607073
1320581	24.0320-0147.1	520147	1579847	13.0441-5409.2	250112	1661467	24.0124-0148.1	424148
1320582	24.0120-0147.1	420147	1583104	13.0441-5409.2	250112	1661473	11.8116-0073.1	390498
1320582	24.0320-0147.1	520147	1583215	03.2120-0151.3	010071	1661490	11.0441-6007.2	250146
1323621	24.0110-0115.1	410115	1591094	13.0460-7042.2	607042	1661491	11.0441-6007.2	250146
1328617	24.3364-1704.5	240310	1591990	24.0110-0148.1	410148	1661851	24.0222-8010.2	480027
1328618	24.3364-1703.5	240309	1591991	24.0110-0148.1	410148	1662293	03.0137-0292.2	650292
1328619	24.3364-1706.5	240312	1591993	24.0113-0118.1	413118	1662294	03.0137-0292.2	650292
1328620	24.3364-1705.5	240311	1591995	24.0113-0122.1	413122	1664703	24.3727-0627.2	580627
1373781	24.0110-0115.1	410115	1591996	24.0113-0122.1	413122	1664811	24.3727-0627.2	580627
1465126	13.0460-7073.2	607073	1595523	13.0460-7071.2	607071	1664872	24.3727-0627.2	580627
1473006	24.0110-0115.1	410115	1595524	13.0460-7027.2	607027	1664975	24.3727-0627.2	580627
1473043	03.0137-0237.2	650237	1595875	24.0124-0112.1	424112	1680868	24.0218-0011.1	480006
1473056	03.0137-0272.2	650272	1598117	24.0218-0010.2	480005	1680869	24.0218-0011.1	480006
1477771	11.3541-8529.2	220341	1604578	24.3541-1701.5	240005	1715410	24.0111-0119.1	411119
1477771	24.3541-8529.5	240553	1613087	24.2119-0905.3	010353	1756882	24.0110-0115.1	410115
1478335	24.3364-1704.5	240310	1613128	13.0460-7027.2	607027	1780880	24.0110-0115.1	410115
1478336	24.3364-1706.5	240312	1613313	13.0460-7042.2	607042	1954433	24.0126-0109.1	426109
1478415	24.3364-1703.5	240309	1613351	83.6339-0228.3	330361	1954460	13.0460-5959.2	605959
1478418	24.3364-1705.5	240311	1613354	24.5302-0296.3	330476	1954475	24.0225-4014.1	480155
1478446	24.3421-1710.5	240698	1613463	24.2120-0905.3	010364	1954496	03.0137-0376.2	650376
1478466	11.3481-8514.2	220336	1619053	24.0124-0112.1	424112	1954497	24.3223-1709.3	020444
1478467	11.3541-8530.2	220342	1619054	24.0124-0112.1	424112	1954498	24.3222-1717.3	020443
1478467	24.3541-8530.5	240554	1619118	24.3727-0628.2	580628	1956495	13.0460-5959.2	605959
1478469	24.3601-8528.5	240504	1619136	03.0137-0164.2	650164	1956522	24.2123-1726.3	010557
1478495	11.3481-8513.2	220335	1619138	24.3217-1114.3	020177	1957042	13.0460-5959.2	605959
1478497	24.3601-8527.5	240503	1619209	13.0460-7071.2	607071	1959359	24.3223-1709.3	020444
1478525	24.3541-1701.5	240005	1619225	11.0441-4805.2	250020	1960416	03.0137-0376.2	650376
1480493	03.2120-5503.3	010124	1619229	24.0124-0112.1	424112	3256541	13.0460-5806.2	605806
1484750	24.3219-1107.3	020338	1629450	24.0110-0148.1	410148	4034886	24.0218-0024.2	480079
1484751	24.3220-1112.3	020223	1629451	24.0110-0148.1	410148	4034886	24.0218-0724.2	480206
1484752	24.3217-1715.3	020463	1629474	24.0124-0112.1	424112	4055730	24.3225-1103.3	020346
1484766	13.0441-4825.2	250107	1629475	24.0110-0193.1	410193	4056029	24.0124-0120.1	424120
1486316	24.3219-1107.3	020338	1629476	24.0124-0112.1	424112	4056029	24.0324-0120.1	524120
1486750	24.3219-1107.3	020338	1629477	24.0110-0193.1	410193	4056031	24.0124-0149.1	424149
1487877	13.0441-5409.2	250112	1629482	24.0124-0112.1	424112	4070864	24.0124-0149.1	424149
1490767	24.0220-3001.2	480020	1629483	24.0124-0112.1	424112	4070865	24.0124-0120.1	424120
1500668	13.0460-3964.2	603964	1629947	24.3728-0625.2	590625	4070865	24.0324-0120.1	524120

Vergleichsliste

Cross reference list - Tabella di conversione codici
 Liste des correspondances - Lista referencias



FORD		FORD		FORD				
4071714	24.0120-0147.1	420147	5023998	13.0460-7040.2	607040	6099238	13.0460-7042.2	607042
4071714	24.0320-0147.1	520147	5023999	13.0460-7041.2	607041	6099243	13.0460-7042.2	607042
4083484	24.0110-0115.1	410115	5024174	24.0124-0148.1	424148	6101928	24.0110-0193.1	410193
4084226	24.0120-0147.1	420147	5024744	24.0110-0193.1	410193	6107088	13.0460-7042.2	607042
4084226	24.0320-0147.1	520147	5025048	13.0460-7073.2	607073	6107104	03.2123-8611.3	010195
4115996	24.0120-0146.1	420146	5025610	24.0124-0131.1	424131	6107581	83.6339-0228.3	330361
4115996	24.0320-0146.1	520146	5025611	24.0124-0132.1	424132	6107582	83.6339-0253.3	330362
5010540	13.0460-6910.2	606910	5025929	13.0460-7073.2	607073	6109375	13.0460-7027.2	607027
5015665	03.0137-0157.2	650157	5025950	24.0124-0125.1	424125	6113662	03.0137-0138.2	650138
5015917	13.0460-7005.2	607005	5025951	24.0110-0213.1	410213	6115618	24.3728-0625.2	590625
5015919	13.0460-7071.2	607071	5026344	03.0137-0254.2	650254	6118140	24.2122-1713.3	010463
5015920	13.0460-7027.2	607027	5026661	13.0460-3965.2	603965	6118143	24.2122-1713.3	010463
5015924	13.0460-7042.2	607042	5026674	24.0124-0148.1	424148	6119634	24.0110-0148.1	410148
5015932	13.0460-6910.2	606910	5026784	24.0124-0120.1	424120	6120915	24.3728-0625.2	590625
5015935	13.0460-6911.2	606911	5026784	24.0324-0120.1	524120	6121606	13.0460-7027.2	607027
5016220	03.0137-0164.2	650164	5026785	24.0124-0149.1	424149	6121696	13.0460-7027.2	607027
5018535	03.0137-9046.2	669046	5026786	24.0120-0146.1	420146	6121697	13.0460-7071.2	607071
5018898	13.0460-7005.2	607005	5026786	24.0320-0146.1	520146	6121989	24.0113-0118.1	413118
5018899	13.0460-7071.2	607071	5027462	24.0124-0121.1	424121	6124275	24.3728-0625.2	590625
5018900	13.0460-7027.2	607027	5027463	24.0124-0121.1	424121	6125634	24.5305-0310.3	331326
5018902	13.0460-7042.2	607042	5027464	24.0110-0186.1	410186	6125636	83.6327-0180.3	330740
5018907	13.0460-6910.2	606910	5027604	13.0460-3965.2	603965	6126854	24.5302-0296.3	330476
5018908	13.0460-6911.2	606911	5027751	03.0137-0237.2	650237	6127520	13.0460-7071.2	607071
5018930	13.0460-7042.2	607042	5027752	03.0137-0238.2	650238	6127527	13.0460-7040.2	607040
5018981	13.0460-2912.2	602912	5027753	03.0137-0282.2	650282	6127528	13.0460-7041.2	607041
5019038	03.0137-0138.2	650138	5028281	24.0120-0147.1	420147	6128159	11.0441-6003.2	250037
5019046	03.0137-0036.2	650036	5028281	24.0320-0147.1	520147	6128542	24.3728-0625.2	590625
5020409	03.0137-0157.2	650157	5028763	13.0460-3960.2	603960	6129003	83.6339-0253.3	330362
5020413	03.0137-0138.2	650138	5028764	13.0460-3959.2	603959	6129626	03.0137-9043.2	669043
5020547	03.0137-0138.2	650138	5029147	13.0460-7057.2	607057	6129627	03.0137-9043.2	669043
5020552	03.0137-0157.2	650157	5029148	13.0460-7056.2	607056	6130483	13.0460-7071.2	607071
5020562	03.0137-0164.2	650164	5029238	11.8116-0301.1	390610	6132471	13.0460-7005.2	607005
5020817	13.0460-7040.2	607040	5029815	24.0124-0131.1	424131	6132472	13.0460-7005.2	607005
5020818	13.0460-7041.2	607041	5029816	24.0124-0132.1	424132	6132473	11.0441-4805.2	250020
5021305	03.0137-0164.2	650164	5030658	24.0110-0115.1	410115	6132484	11.0441-4805.2	250020
5021734	24.3541-1701.5	240005	6009659	24.3220-1112.3	020223	6132807	13.0460-7071.2	607071
5022253	24.0113-0118.1	413118	6010149	24.0113-0118.1	413118	6132808	13.0460-7027.2	607027
5022397	13.0460-6910.2	606910	6010229	24.0113-0122.1	413122	6132910	24.5302-0296.3	330476
5022398	13.0460-6911.2	606911	6016236	03.2119-0525.3	010046	6133549	24.0124-0112.1	424112
5022650	24.0110-0148.1	410148	6023398	24.3219-0903.3	020184	6133550	24.0124-0112.1	424112
5022651	24.0110-0148.1	410148	6023399	24.3217-1706.3	020044	6133554	11.8116-0052.1	390496
5022652	24.0110-0196.1	410196	6035875	24.3215-1104.3	020158	6134507	24.0124-0112.1	424112
5022653	24.0110-0196.1	410196	6041696	24.0114-0100.1	414100	6135220	24.5305-0370.3	331392
5022654	24.0120-0147.1	420147	6046462	24.0217-8001.1	480002	6136543	24.2122-0906.3	010378
5022654	24.0320-0147.1	520147	6046469	24.2119-0905.3	010353	6136834	24.2122-1712.3	010462
5022658	24.0110-0193.1	410193	6049290	24.3727-0619.2	580619	6136892	13.0460-7040.2	607040
5022659	24.0124-0112.1	424112	6063234	24.3215-1104.3	020158	6136893	13.0460-7071.2	607071
5022660	24.0124-0112.1	424112	6063755	24.0222-8010.2	480027	6137291	24.0110-0193.1	410193
5022661	24.0124-0113.1	424113	6066679	24.3728-0623.2	590623	6137292	24.0220-3001.2	480020
5022663	24.0124-0113.1	424113	6067715	24.2119-0905.3	010353	6139192	24.3728-0615.2	590615
5022664	24.0124-0151.1	424151	6069635	03.2119-0525.3	010046	6139438	24.3727-0616.2	580616
5022666	24.0110-0115.1	410115	6069636	03.0120-0148.3	010070	6139621	24.3727-0617.2	580617
5022669	24.0110-0186.1	410186	6069637	03.2120-0148.3	010070	6140343	24.3728-0622.2	590622
5022671	24.0113-0118.1	413118	6070682	24.0220-3001.2	480020	6141149	13.0460-2933.2	602933
5022674	24.0114-0100.1	414100	6077974	24.0124-0112.1	424112	6141433	24.3727-0625.2	580625
5022676	24.0114-0103.1	414103	6077975	24.0110-0193.1	410193	6142943	24.0220-3001.2	480020
5022677	24.0114-0100.1	414100	6079642	24.3215-1104.3	020158	6143701	24.3728-0623.2	590623
5022829	24.0113-0122.1	413122	6083867	24.2122-1702.3	010421	6144685	13.0460-7071.2	607071
5022947	24.0110-0193.1	410193	6086628	24.0218-0010.2	480005	6147496	13.0460-7071.2	607071
5022948	24.0124-0112.1	424112	6087576	11.0441-5402.2	250028	6149181	24.5245-0405.3	330686
5022949	24.0110-0186.1	410186	6087582	11.0441-5402.2	250028	6149182	24.5245-0398.3	331188
5023224	24.3541-1701.5	240005	6087586	11.8171-0008.1	990049	6150092	03.0137-0254.2	650254
5023225	24.3434-1602.5	240020	6088222	03.0137-9043.2	669043	6150095	03.0137-0292.2	650292
5023226	24.3434-1601.5	240019	6088234	24.3222-1117.3	020272	6150270	03.0137-0138.2	650138
5023441	24.0124-0121.1	424121	6089874	24.0110-0148.1	410148	6150894	24.0711-1301.1	360015
5023483	24.0110-0115.1	410115	6089875	24.0110-0148.1	410148	6151044	24.2123-1756.3	010756
5023486	13.0460-3944.2	603944	6089876	24.0110-0148.1	410148	6151046	24.2123-1705.3	010440
5023573	24.0124-0112.1	424112	6090605	24.3215-1104.3	020158	6152221	24.3434-1602.5	240020
5023732	24.0113-0118.1	413118	6091956	24.3728-0615.2	590615	6152222	24.3434-1602.5	240020
5023994	13.0460-7071.2	607071	6091957	24.3728-0615.2	590615	6152223	24.3434-1601.5	240019
5023996	13.0460-2912.2	602912	6095773	13.0460-7071.2	607071	6152224	24.3434-1601.5	240019



Vergleichsliste

Cross reference list - Tabella di conversione codici



Liste des correspondances - Lista referencias

FORD		FORD		FORD				
6153883	24.3728-0625.2	590625	6187601	24.3219-1106.3	020192	6668587	13.0460-7165.2	607165
6154078	11.0441-6003.2	250037	6187602	24.3222-1111.3	020266	6668590	24.3601-8528.5	240504
6154286	24.3727-0618.2	580618	6188427	13.0460-7073.2	607073	6668592	24.3601-8527.5	240503
6155610	13.0460-2933.2	602933	6188429	24.3541-1701.5	240005	6668594	11.0441-6007.2	250146
6155611	13.0460-7027.2	607027	6189145	13.0460-7071.2	607071	6669768	24.3364-1704.5	240310
6155623	13.0460-7041.2	607041	6189146	13.0460-7071.2	607071	6669769	24.3364-1703.5	240309
6156352	24.0110-0148.1	410148	6189147	13.0460-7040.2	607040	6669777	11.0101-5407.2	260011
6157177	13.0460-7041.2	607041	6189148	13.0460-7040.2	607040	6669779	13.0460-3963.2	603963
6158202	24.0124-0112.1	424112	6189769	13.0460-2933.2	602933	6669780	13.0460-3964.2	603964
6158203	24.0110-0193.1	410193	6191062	24.0110-0196.1	410196	6676122	24.3727-0627.2	580627
6158204	24.0124-0112.1	424112	6191063	24.0110-0196.1	410196	6700130	24.3364-1706.5	240312
6158205	24.0110-0193.1	410193	6191064	24.0120-0147.1	420147	6700131	24.3364-1705.5	240311
6158210	24.0124-0112.1	424112	6191064	24.0320-0147.1	520147	6704268	13.0460-7071.2	607071
6158211	24.0124-0112.1	424112	6191842	24.5303-0400.3	330404	6704269	13.0460-7040.2	607040
6158212	24.0110-0148.1	410148	6192365	03.0137-0254.2	650254	6704270	13.0460-7041.2	607041
6158213	24.0110-0148.1	410148	6192490	24.0220-3008.2	480075	6704271	13.0460-3965.2	603965
6158214	24.0124-0109.1	424109	6193694	24.0124-0121.1	424121	6710010	24.0222-8014.1	480031
6158215	24.0110-0186.1	410186	6194541	24.3727-0616.2	580616	6710016	03.0137-0253.2	650253
6158945	13.0460-7071.2	607071	6194542	24.3727-0618.2	580618	6710017	03.0137-0253.2	650253
6159054	24.3727-0617.2	580617	6196051	24.3220-1112.3	020223	6714710	24.5306-0295.3	330662
6162190	13.0460-7073.2	607073	6196052	24.3219-1107.3	020338	6723389	24.3727-0633.2	580633
6162337	13.0460-2933.2	602933	6196053	24.3222-1117.3	020272	6733350	03.0137-0291.2	650291
6162338	13.0460-2928.2	602928	6197738	13.0460-3960.2	603960	6750550	24.3727-0638.2	580638
6162658	03.0137-0157.2	650157	6197739	13.0460-3959.2	603959	6754692	24.2123-1724.3	010566
6163735	24.3727-0617.2	580617	6197741	24.3421-1710.5	240698	6758577	83.7114-0376.3	330373
6165965	13.0460-6911.2	606911	6198026	24.0228-0001.1	480068	6758585	83.6227-0281.3	330424
6166055	24.0114-0103.1	414103	6203650	13.0460-7073.2	607073	6758587	83.6114-0300.3	330258
6166056	24.0114-0100.1	414100	6442332	24.0110-0186.1	410186	6781601	24.2125-1707.3	010497
6166952	13.0460-7071.2	607071	6449782	11.0441-6007.2	250146	6789916	24.2419-1723.3	030112
6166953	13.0460-7027.2	607027	6450826	24.0124-0121.1	424121	6790835	03.6043-1784.3	320034
6166967	24.3727-0631.2	580631	6464214	24.0225-4004.1	480069	6790836	03.6043-1773.3	320030
6166968	24.3727-0632.2	580632	6464704	24.3222-1124.3	020344	6790837	03.6043-1783.3	320033
6166969	24.3727-0630.2	580630	6464705	24.3220-1121.3	020343	6808555	24.3220-1111.3	020222
6167629	24.0222-8011.1	480028	6464706	24.3225-1103.3	020346	6808556	24.3222-1116.3	020271
6168109	24.0124-0121.1	424121	6483825	24.0711-1333.3	360020	6808557	24.3222-1114.3	020269
6168200	24.3727-0625.2	580625	6492327	24.0218-0024.2	480079	6827588	13.0460-7057.2	607057
6168201	24.3727-0622.2	580622	6492327	24.0218-0724.2	480206	6828211	24.5303-0455.3	330588
6168203	24.3727-0618.2	580618	6500943	03.0137-0237.2	650237	6837899	03.6043-1776.3	320032
6169520	24.3727-0617.2	580617	6500944	03.0137-0238.2	650238	6837900	03.6043-1786.3	320035
6169974	24.0124-0113.1	424113	6500945	03.0137-0282.2	650282	6837963	24.0220-3006.1	480062
6169975	24.0124-0113.1	424113	6500952	13.0460-3965.2	603965	6842331	24.2123-1606.3	010386
6170667	24.2120-1739.3	010762	6500954	13.0460-3965.2	603965	6854704	24.3727-0639.2	580639
6171464	24.3727-0631.2	580631	6500959	13.0460-4058.2	604058	6877835	13.0460-7163.2	607163
6173278	24.2122-1603.3	010381	6501431	11.0441-6007.2	250146	6877836	13.0460-7057.2	607057
6174117	13.0460-7071.2	607071	6502746	24.3727-0628.2	580628	6877837	13.0460-7056.2	607056
6174503	24.3728-0601.2	590601	6511773	13.0460-7071.2	607071	6882582	13.0460-7060.2	607060
6175343	13.0460-2933.2	602933	6559229	24.0222-8010.2	480027	6882584	13.0460-7057.2	607057
6175345	24.0711-1139.1	360006	6559230	03.0137-0157.2	650157	6912221	24.3727-0627.2	580627
6176621	11.3481-8512.2	220338	6560026	24.0218-0024.2	480079	6920296	03.0137-9217.2	669217
6176623	11.3481-8511.2	220337	6560026	24.0218-0724.2	480206	6920297	03.0137-9251.2	669251
6176743	24.0218-0024.2	480079	6560027	24.0220-3002.2	480021	6920710	24.0218-0024.2	480079
6176743	24.0218-0724.2	480206	6560028	24.0220-3004.2	480023	6920710	24.0218-0724.2	480206
6176744	24.0220-3002.2	480021	6567001	13.0460-6910.2	606910	6920711	24.0220-3004.2	480023
6177228	03.0137-0164.2	650164	6567002	13.0460-6911.2	606911	6922548	24.2123-1606.3	010386
6177410	24.3728-0627.2	590627	6569119	24.5303-0400.3	330404	6922621	24.5164-0315.3	331209
6177473	03.0137-0292.2	650292	6577423	24.5236-0429.3	330586	6924890	24.3727-0639.2	580639
6178479	13.0460-7071.2	607071	6577424	24.5236-0430.3	330587	6941703	24.5129-0395.3	330582
6178480	13.0460-7071.2	607071	6577425	24.5245-0405.3	330686	6941705	24.5129-0396.3	330583
6179304	24.5302-0295.3	330403	6577426	24.5245-0398.3	331188	6944442	24.3727-0644.2	580644
6180371	13.0460-3965.2	603965	6579150	03.0137-0290.2	650290	6960026	83.7114-0376.3	330373
6180378	24.3541-1708.5	240068	6581520	24.2123-1606.3	010386	6974959	24.2125-1707.3	010497
6180380	24.3541-1707.5	240067	6612561	24.3728-0601.2	590601	6978969	03.0137-0235.2	650235
6181209	03.0137-9124.2	669124	6616408	24.0711-1323.1	360019	7018202	13.0460-3960.2	603960
6183822	24.0220-3001.2	480020	6627122	03.6043-1774.3	320031	7018203	13.0460-3959.2	603959
6183876	03.0137-0235.2	650235	6643690	24.5304-0280.3	330589	7034902	24.2123-1724.3	010566
6183877	03.0137-0236.2	650236	6645754	24.2120-1604.3	010370	7043631	24.3727-0641.2	580641
6184245	13.0460-3944.2	603944	6658706	24.3727-0636.2	580636	7055297	03.0137-0253.2	650253
6184958	24.0711-1129.1	360002	6658707	24.3727-0637.2	580637	7067563	83.7114-0376.3	330373
6186923	11.0101-5407.2	260011	6658751	24.3727-0626.2	580626	7098234	24.0220-3008.2	480075
6187321	24.3541-1701.5	240005	6668584	11.8116-0301.1	390610	7100750	24.2123-1606.3	010386
6187600	24.3217-1601.3	020180	6668585	11.8116-0143.1	390513	7114005	13.0460-4058.2	604058

Vergleichsliste

Cross reference list - Tabella di conversione codici

Liste des correspondances - Lista referencias



FORD 			FORD 			FORD 		
7117257	24.3219-1717.3	020415	93BB-2078-AB	83.7114-0376.3	330373	97BG-2K021-BA	13.0460-7057.2	607057
7117258	24.2120-1606.3	010582	93BB-2078-AD	83.7114-0376.3	330373	97BG-2K021-BB	13.0460-7057.2	607057
7127225	24.3727-0662.2	580662	93BB-2078-AE	83.7114-0376.3	330373	97BG-2L231-AA	24.3601-8528.5	240504
7143733	10.6123-0154.3	010578	93BB-2282-AA	83.6227-0281.3	330424	97BG-2L231-CA	24.3601-8528.5	240504
7153476	13.0460-3963.2	603963	93BB-2282-CA	83.6114-0300.3	330258	97BG-2L232-AA	24.3601-8527.5	240503
7153477	13.0460-3964.2	603964	93BB-2282-DD	24.5164-0315.3	331209	97BG-2L232-CA	24.3601-8527.5	240503
7166588	03.0137-0235.2	650235	93BB-2552-AA	24.3364-1704.5	240310	97BG-2L410-AA	03.6043-1953.3	320201
7176735	03.0137-0272.2	650272	93BB-2552-AB	24.3364-1704.5	240310	97BG-2L410-AB	03.6043-1953.3	320201
71BB-2140-TB	03.2120-5503.3	010124	93BB-2552-AC	24.3364-1704.5	240310	97BG-2L410-BA	03.6043-1954.3	320226
7201659	11.0101-5407.2	260011	93BB-2552-AD	24.3364-1704.5	240310	97BG-2L410-BB	03.6043-1954.3	320226
7201660	11.8171-0008.1	990049	93BB-2552-BA	24.3364-1706.5	240312	97BG-2L410-CA	03.6043-1956.3	320202
7204066	24.0110-0115.1	410115	93BB-2552-BB	24.3364-1706.5	240312	97BG-2L410-CB	03.6043-1956.3	320202
7264793	24.3727-0638.2	580638	93BB-2552-BC	24.3364-1706.5	240312	97BX-2B294-CA	24.3601-8528.5	240504
7264799	24.3727-0644.2	580644	93BB-2552-BE	24.3364-1706.5	240312	97BX-2B302-CA	24.3601-8527.5	240503
7267808	03.0137-0253.2	650253	93BB-2553-AA	24.3364-1703.5	240309	9S51-1113-AA	24.0218-0011.1	480006
7272225	24.5303-0455.3	330588	93BB-2553-AB	24.3364-1703.5	240309	9S51-1113-BA	24.0218-0011.1	480006
7296356	24.0218-0024.2	480079	93BB-2553-AC	24.3364-1703.5	240309	9S51-1113-CA	24.0218-0011.1	480006
7296356	24.0218-0724.2	480206	93BB-2553-AD	24.3364-1703.5	240309	9S51-1113-DA	24.0218-0011.1	480006
7376434	24.3727-0642.2	580642	93BB-2553-BA	24.3364-1705.5	240311	9S51-1125-CA	24.0111-0119.1	411119
75AB-2140-HB	03.2119-0525.3	010046	93BB-2553-BB	24.3364-1705.5	240311	BS51-1125-AA	24.0111-0119.1	411119
78AB-2140-JA	03.2119-0525.3	010046	93BB-2553-BC	24.3364-1705.5	240311	C1BC-2A315-AA	24.0110-0115.1	410115
78BB-2140-AA	03.2120-0151.3	010071	93BB-2553-BE	24.3364-1705.5	240311	D72VB-2078-BA	83.6104-0450.3	330251
78EB-2140-BA	03.2120-0148.3	010070	93BB-2B486-AA	11.8116-0301.1	390610	E92Z-1125-A	24.0124-0105.1	424105
81AB-2282-FA	83.6339-0228.3	330361	93BB-2B486-CA	11.8116-0143.1	390513	E92Z-2001-A	13.0460-5932.2	605932
81AB-2282-FB	83.6339-0228.3	330361	93BB-2B507-BB	24.2125-1707.3	010497	E92Z-2C026-A	24.0110-0181.1	410181
81AB-2282-GA	83.6339-0253.3	330362	93BB-2K021-DC	13.0460-7163.2	607163	P02Z-2200-A	13.0460-5995.2	605995
81AB-2282-GC	83.6339-0253.3	330362	93BB-2K021-DD	13.0460-7163.2	607163	R85FX-2N119-AA	24.3541-1701.5	240005
81AB-2B107-AA	11.0441-5402.2	250028	93BB-2K021-EB	13.0460-7057.2	607057	R85FX-2N119-AB	24.3541-1701.5	240005
81AB-2L484-AA	11.0441-5402.2	250028	93BB-2K021-FB	13.0460-7056.2	607056	R89FX-2B294-AB	11.3481-8512.2	220338
81AB-2L527-AA	11.8171-0008.1	990049	93BB-2L231-AA	24.3601-8528.5	240504	R89FX-2B302-AB	11.3481-8511.2	220337
82GB-2140-AA	03.2123-8611.3	010195	93BB-2L232-AA	24.3601-8527.5	240503	R93BX-2552-AD	24.3364-1704.5	240310
83BB-2B107-BA	11.0441-6003.2	250037	93BB-2L410-AA	03.6043-1774.3	320031	R93BX-2552-AE	24.3364-1704.5	240310
83BB-2L484-BB	11.0441-6003.2	250037	93BB-2L410-BB	03.6043-1784.3	320034	R93BX-2552-BE	24.3364-1706.5	240312
84FB-2B107-AA	11.0441-4805.2	250020	93BB-2L410-EA	03.6043-1773.3	320030	R93BX-2552-BF	24.3364-1706.5	240312
84FB-2L484-AA	11.0441-4805.2	250020	93BB-2L410-FA	03.6043-1783.3	320033	R93BX-2553-AD	24.3364-1703.5	240309
84FG-2B107-AA	11.0441-4805.2	250020	93BB-2L410-GA	03.6043-1776.3	320032	R93BX-2553-AE	24.3364-1703.5	240309
85FX-2N119-AA	24.3541-1701.5	240005	93BB-2L410-HA	03.6043-1786.3	320035	R93BX-2553-BE	24.3364-1705.5	240311
85FX2-N119-AA	24.3541-1701.5	240005	93BB-2L484-AA	11.0441-6007.2	250146	R93BX-2553-BF	24.3364-1705.5	240311
85GB-2078-AA	24.5305-0310.3	331326	93BX-2L051-AA	11.8116-0301.1	390610	R96FX-2B294-AA	11.3481-8514.2	220336
85GB-2282-AA	83.6327-0180.3	330740	93BX-2L051-BA	11.8116-0143.1	390513	R96FX-2B294-AB	11.3481-8514.2	220336
85GB-2B486-AA	11.8116-0052.1	390496	93BG-2K021-AC	13.0460-7060.2	607060	R96FX-2B294-BA	11.3541-8530.2	220342
85GG-2B372-AD	24.0711-1129.1	360002	93BG-2K021-CA	13.0460-7057.2	607057	R96FX-2B294-CA	24.3541-8530.5	240554
85GG-2B372-CB	24.0711-1301.1	360015	93BG-2K021-CB	13.0460-7057.2	607057	R96FX-2B294-BB	11.3541-8530.2	220342
86VB-2282-BB	24.5245-0405.3	330686	94BB-2B507-AA	24.2125-1707.3	010497	R96FX-2B294-BB	24.3541-8530.5	240554
86VB-2282-CC	24.5245-0398.3	331188	94BB-7A543-AD	24.2419-1723.3	030112	R96FX-2B302-AA	11.3481-8513.2	220335
86VB-2A032-BA	24.2123-1756.3	010756	94VB-2140-AB	24.2123-1724.3	010566	R96FX-2B302-AB	11.3481-8513.2	220335
87AB-2282-AA	83.6339-0228.3	330361	94VB-2B507-BA	10.6123-0154.3	010578	R96FX-2B302-BA	11.3541-8529.2	220341
87AB-2282-BA	83.6339-0253.3	330362	95GJ-2A315-EC	24.0110-0115.1	410115	R96FX-2B302-BA	24.3541-8529.5	240553
87BG-2B372-EA	24.0711-1139.1	360006	95GX-2A315-EB	24.0110-0115.1	410115	R96FX-2B302-BB	24.3541-8529.5	240553
88AB-2L526-AA	11.0101-5407.2	260011	95VW-2L527-AA	11.8171-0008.1	990049	R97BX-2B294-CA	24.3601-8528.5	240504
89BB-2K021-AB	13.0460-7071.2	607071	95VW-2M032-AA	11.0441-5704.2	250034	R97BX-2B294-CB	24.3601-8528.5	240504
89FB-2140-AA	24.2120-1739.3	010762	96FB-2261-AA	24.3217-1715.3	020463	R97BX-2B302-CA	24.3601-8527.5	240503
89FB-2L231-AB	11.3481-8512.2	220338	96FB-2282-BA	24.5304-0280.3	330589	R97BX-2B302-CB	24.3601-8527.5	240503
89FB-2L232-AB	11.3481-8511.2	220337	96FB-2L231-AA	11.3481-8514.2	220336	V86BB-2B107-AA	13.0441-4015.2	250080
89FB-2L232-BC	24.3541-1701.5	240005	96FB-2L231-BA	11.3541-8530.2	220342	V89BB-2B107-AA	11.0441-6007.2	250146
89FX-2B294-AB	11.3481-8512.2	220338	96FB-2L231-BA	24.3541-8530.5	240554	V89BB-2B486-AA	11.8116-0073.1	390498
89FX-2B302-AB	11.3481-8511.2	220337	96FB-2L232-AA	11.3481-8513.2	220335	V89BB-2L484-AA	11.0441-6007.2	250146
89GB-2K021-AB	13.0460-7040.2	607040	96FB-2L232-BA	11.3541-8529.2	220341	VX443-611190-VX	03.3517-5100.1	390326
89GB-2K021-BB	13.0460-7041.2	607041	96FB-2L232-BA	24.3541-8529.5	240553	XK-186580	03.3508-4903.3	310032
91AB-2140-ED	24.2123-1606.3	010386	96FX-2B135-AA	11.0230-0687.1	260106	XS51-2261-AA	24.3217-1715.3	020463
91AB-2B372-AA	24.0711-1323.1	360019	96FX-2B294-AA	11.3481-8514.2	220336	YS61-2282-AD	24.5305-0310.3	331326
91AB-2L484-BA	11.0441-6007.2	250146	96FX-2B294-BA	11.3541-8530.5	240554			
91AB-2M008-BD	13.0460-4058.2	604058	96FX-2B302-AA	11.3481-8513.2	220335			
91AG-2B372-BA	24.0711-1333.3	360020	96FX-2B302-BA	11.3541-8529.2	220341	000 295 89 07	03.2525-2602.3	040029
91FB-2282-AA	24.5306-0295.3	330662	96FX-2B302-BA	24.3541-8529.5	240553	000 428 01 35	83.6103-0450.3	330228
92AB-2078-BB	24.5129-0395.3	330582	96FX-2B302-BA	83.6118-0281.3	330483	000 428 76 35	83.6133-0500.3	330272
92AB-2078-DB	24.5129-0396.3	330583	97BG-2282-AA	83.6362-0542.3	330485	000 431 70 12	03.6521-0012.3	320094
92VB-2004AA	24.2123-1724.3	010566	97BG-2282-BB	83.6362-0542.3	330485	000 586 33 29	03.0450-2509.2	082509
92VB-2282-AA	24.5245-0405.3	330686	97BG-2282-BC	83.6362-0542.3	330485	000 586 46 29	03.0450-2510.2	082510
92VB-2282-BA	24.5245-0398.3	331188	97BG-2K021-AA	13.0460-7056.2	607056	001 428 21 35	83.6123-0465.3	330379
92VX-2B120-BB	24.3421-1710.5	240698	97BG-2K021-AB	13.0460-7056.2	607056			



Vergleichsliste

Cross reference list - Tabella di conversione codici



Liste des correspondances - Lista referencias

HANOMAG 		HONDA 		HONDA 				
001 428 53 35	83.6123-0465.3	330379	04431-ST3-E00	03.0137-0339.2	650339	43022-SZ3-E50	13.0460-5711.2	605711
002 420 88 18	03.3222-5804.3	020083	06022-SP8-000	13.0460-5998.2	605998	43022-TF2-G00	13.0460-5929.2	605929
004 317 012	03.6521-0012.3	320094	42510-SD4-000	24.0110-0267.1	410267	43022-TM8-G01	13.0460-5929.2	605929
005 420 78 18	03.3222-7802.3	020088	42510-SE0-000	24.0110-0212.1	410212	43023-SK3-E00	24.3304-1701.5	240113
009 420 83 18	03.3222-7802.3	020088	42510-SE0-010	24.0110-0212.1	410212	43024-SK3-E10	03.0137-9221.2	669221
084 779 000	03.3131-0102.3	010296	42510-SG9-000	24.0110-0255.1	410255	43030-SP8-000	24.3219-1710.3	020386
1020 52 05	03.3122-0101.3	010277	42510-SG9-010	24.0110-0255.1	410255	43053-S2G-E50	03.0137-0294.2	650294
1120 050 431	83.6103-0500.3	330230	42510-SH3-G00	24.0110-0212.1	410212	43053-S5A-E50	03.0137-0294.2	650294
1820 050 121	83.6203-0200.3	330298	42510-SK3-305	24.0110-0212.1	410212	43053-SM4-E50	03.0137-0287.2	650287
1820 050 211	83.6203-0300.3	330386	42510-SK3-E00	24.0110-0212.1	410212	43053-SR3-A00	03.0137-0284.2	650284
1820 050 501	03.3304-0700.1	390082	42510-SM4-950	24.0110-0233.1	410233	43153-S04-A01	03.0137-0284.2	650284
1820 050 521	83.6123-0465.3	330379	42510-SN7-000	24.0110-0233.1	410233	43153-S2G-951	03.0137-0294.2	650294
1820 053 310	03.3222-4401.3	020076	42510-SP0-000	24.0109-0132.1	409132	43153-S2H-003	03.0137-0294.2	650294
1820 054 561	03.3304-0700.1	390082	42510-SR3-000	24.0109-0111.1	409111	43153-S5A-J01	03.0137-0294.2	650294
1820 055 141	83.6103-0200.3	330219	42510-SR3-A10	24.0109-0111.1	409111	43153-S6A-J01	03.0137-0287.2	650287
1823 050 310	03.3222-4401.3	020076	42510-SR3-A11	24.0109-0111.1	409111	43153-SA2-601	03.0137-0179.2	650179
1823 053 041	03.3318-0800.2	390112	42510-SR3-G00	24.0109-0111.1	409111	43153-SB2-003	03.0137-0179.2	650179
1823 053 310	03.3222-4401.3	020076	42510-SR3-J00	24.0109-0111.1	409111	43153-SB2-601	03.0137-0179.2	650179
2121 050 131	83.6192-0250.3	330726	42510-SS0-000	24.0110-0267.1	410267	43153-SB2-603	03.0137-0179.2	650179
247 925 719	03.3508-0401.3	310014	42510-SS0-J00	24.0110-0267.1	410267	43153-SE0-003	03.0137-0294.2	650294
2840 498 M92	03.3138-2001.3	010310	42510-SV1-A00	24.0110-0233.1	410233	43153-SE0-013	03.0137-0294.2	650294
2930 599 M91	13.0441-5718.2	250120	42510-SV4-A00	24.0110-0233.1	410233	43153-SE0-N51	03.0137-0294.2	650294
2945 478 M91	03.3138-2001.3	010310	42510-SX0-000	24.0109-0132.1	409132	43153-SE0-S01	03.0137-0294.2	650294
2962 254 M91	83.6103-0320.3	330224	42610-SB2-000	24.0218-0018.1	480063	43153-SH3-003	03.0137-0179.2	650179
2966 133 M1	83.6103-0600.3	330233	42610-SB2-010	24.0218-0018.1	480063	43153-SH3-013	03.0137-0179.2	650179
2977 278 M91	03.0370-1038.2	051038	42610-SK3-E10	24.0220-3016.1	480107	43153-SH3-023	03.0137-0179.2	650179
2977 278 M91	03.0370-9998.2	059998	42610-SM4-010	24.0222-0001.1	480123	43153-SH3-A01	03.0137-0179.2	650179
2998 825 M1	03.3509-0100.3	310057	43012-ST3-E00	24.3304-1702.5	240114	43153-SH3-A02	03.0137-0179.2	650179
3083 208 M91	03.3508-0501.3	310017	43013-ST3-E00	24.3304-1701.5	240113	43153-SH3-G02	03.0137-0179.2	650179
3083 212 M91	03.3117-1408.3	010255	43015-SP8-000	03.0137-0339.2	650339	43153-SJ6-023	03.0137-0294.2	650294
3227 885 M91	03.3115-2651.3	010250	43021-SK3-E00	24.3304-1702.5	240114	43153-SM4-003	03.0137-0294.2	650294
418 646 M1	03.3508-0264.3	310009	43022-S2A-000	13.0460-5929.2	605929	43153-SM4-A01	03.0137-0287.2	650287
418 652 946	83.6103-0650.3	330235	43022-S2A-E50	13.0460-5929.2	605929	43153-SR3-003	03.0137-0179.2	650179
418 654 017	83.6103-0500.3	330230	43022-S3N-000	13.0460-5711.2	605711	43153-SR3-A01	03.0137-0284.2	650284
4227 083 M91	03.3508-0264.3	310009	43022-S3N-E50	13.0460-5711.2	605711	43153-SR4-A02	03.0137-0294.2	650294
4227 410 M91	03.3115-2651.3	010250	43022-S5A-E50	13.0460-5929.2	605929	43153-SR7-003	03.0137-0294.2	650294
534 922 902	03.0370-1828.2	051828	43022-S5A-J00	13.0460-5929.2	605929	43153-ST0-J01	03.0137-0294.2	650294
536 922 705	03.3128-1401.3	010295	43022-S6D-000	13.0460-5929.2	605929	43153-SV4-J01	03.0137-0294.2	650294
540 144 061	83.6123-0471.3	330263	43022-S6D-E50	13.0460-5929.2	605929	43154-SM4-A01	03.0137-0287.2	650287
540 184 013	03.3318-0800.2	390112	43022-S7S-010	13.0460-5711.2	605711	43155-SM4-A01	03.0137-0287.2	650287
541 922 709	03.3508-0401.3	310014	43022-S9A-E51	13.0460-5711.2	605711	43171-S04-N01	03.0137-9096.2	669096
582 908 104	83.6103-0200.3	330219	43022-S9A-E52	13.0460-5711.2	605711	43171-SK3-E10	03.0137-9221.2	669221
582 923 265	24.5201-0220.3	331272	43022-SE0-000	13.0460-5998.2	605998	43172-S04-003	03.0137-9096.2	669096
582 923 734	03.2122-0704.3	010134	43022-SE0-930	13.0460-5998.2	605998	43172-S04-N01	03.0137-9096.2	669096
583 303 929	03.3509-0100.3	310057	43022-SE0-931	13.0460-5998.2	605998	43172-SK3-E10	03.0137-9221.2	669221
583 303 944	83.6103-0450.3	330228	43022-SE0-S00	13.0460-5998.2	605998	43172-ST3-E01	03.0137-9221.2	669221
583 303 945	83.6103-0650.3	330235	43022-SED-000	13.0460-5711.2	605711	43175-SK3-E10	03.0137-9221.2	669221
583 303 949	83.6103-0500.3	330230	43022-SED-E50	13.0460-5711.2	605711	43175-ST3-E01	03.0137-9221.2	669221
583 925 711	03.2123-3302.3	010180	43022-SED-E60	13.0460-5711.2	605711	43183-SK3-E10	03.0137-9221.2	669221
5954 390 410	03.2522-2612.3	040012	43022-SF1-S00	13.0460-5998.2	605998	43183-ST3-E01	03.0137-9221.2	669221
603 420 00 18	24.3222-1733.3	020538	43022-SF1-S01	13.0460-5998.2	605998	43185-SK3-E10	03.0137-9221.2	669221
773 922 701	03.3138-2001.3	010310	43022-SG9-V00	13.0460-2800.2	602800	43185-ST3-E01	03.0137-9221.2	669221
774 922 701	03.3138-2001.3	010310	43022-SJF-E00	13.0460-5711.2	605711	43227-SG0-013	13.0460-0287.2	610287
780 924 746	03.3508-0401.3	310014	43022-SL5-000	13.0460-5929.2	605929	43244-SG0-003	13.0460-0287.2	610287
974 010 004	83.6103-0470.3	330229	43022-SM4-G00	13.0460-5929.2	605929	43244-SZ3-A01	13.0460-0287.2	610287
974 010 005	83.6103-0620.3	330234	43022-SN7-000	13.0460-5929.2	605929	43300-S04-003	24.3219-1724.3	020428
974 010 006	83.6103-0470.3	330229	43022-SN7-E50	13.0460-5929.2	605929	43300-SA3-681	24.3219-1122.3	020364
974 010 008	83.6103-0620.3	330234	43022-SN7-E50HE	13.0460-5929.2	605929	43300-SB2-003	24.3219-1122.3	020364
974 010 009	83.6203-0260.3	330300	43022-SP0-E01	13.0460-5711.2	605711	43300-SH3-J01	24.3219-1724.3	020428
974 010 016	83.6123-0471.3	330263	43022-SR3-G00	13.0460-5998.2	605998	43300-SM4-A01	24.3219-1724.3	020428
974 010 017	83.6123-0381.3	330262	43022-SR3-G01	13.0460-5998.2	605998	43300-SR3-003	24.3219-1724.3	020428
974 160 001	83.6103-0600.3	330233	43022-ST3-E00	13.0460-5998.2	605998	43300-ST3-E01	24.3219-1743.3	020485
9987 4225 002	83.6103-0620.3	330234	43022-ST3-E50	13.0460-5998.2	605998	43301-S04-003	24.3219-1723.3	020427
X86.0024.2088.18/00	03.3222-5804.3	020083	43022-SV4-A00	13.0460-5929.2	605929	43301-SA3-681	24.3219-1121.3	020363
X86.0536.9227.05/00	03.3128-1401.3	010295	43022-SV4-A20	13.0460-5929.2	605929	43301-SB2-003	24.3219-1121.3	020363
			43022-SV4-E50	13.0460-5929.2	605929	43301-SH3-J01	24.3219-1723.3	020427
			43022-SV4-G00	13.0460-5929.2	605929	43301-SM4-A01	24.3219-1723.3	020427
			43022-SV4-G21	13.0460-5929.2	605929	43301-SR3-003	24.3219-1723.3	020427
			43022-SV4-G22	13.0460-5929.2	605929	43301-ST3-E01	24.3219-1743.3	020485
			43022-SY8-A01	13.0460-5929.2	605929	44400-SK3-E10	24.0121-0107.1	421107
			43022-SZ3-A01	13.0460-5711.2	605711	45004-SEA-E01	11.8171-0008.1	990049
HENSCHEL								
1 085 234	83.6103-0600.3	330233						
920 616	83.6103-0320.3	330224						
924 746	03.3508-0401.3	310014						

Vergleichsliste

Cross reference list - Tabella di conversione codici



Liste des correspondances - Lista referencias

HYUNDAI 			JEEP 			LADA 		
MB858405	24.3431-1706.5	240366	5200 5000	24.0124-0702.1	424702	2110-3501089	13.0460-2965.2	602965
MN116706	24.0122-0175.1	422175	5200 7710	24.0124-0702.1	424702	2121-3501070	24.0112-0130.1	412130
ISUZU			5200 8264	24.0124-0702.1	424702	2121-3501090	13.0460-8006.2	608006
8-94172-376-1	24.0122-0156.1	422156	5200 8440	24.0124-0702.1	424702	2121-3502070	24.0225-0004.1	480058
8-94173-244-0	24.0112-0145.1	412145	83 03 251 156	24.0122-0181.1	422181	2121-3505009	24.2119-0832.3	010417
8-94173-244-2	24.0112-0145.1	412145	98 83 251 156	24.0122-0181.1	422181	2121-3508180	24.3727-2401.2	582401
8-94230-541-4	24.3225-1702.3	020425	J325 1156	24.0122-0181.1	422181	LAND ROVER		
8-94388-016-0	24.3601-1716.5	240390	KÄSSBOHRER			FRC7329	24.0114-0108.1	414108
8-94388-017-0	24.3601-1715.5	240389	4.527.005.000	83.6103-0500.3	330230	FRC7392	24.0114-0108.1	414108
8-94461-155-0	13.0460-5942.2	605942	8.282.095.000	03.3131-0601.3	010299	FRC9831	24.0113-0189.1	413189
8-97127-616-0	24.3225-1702.3	020425	8.282.095.100	03.3131-0601.3	010299	FTC1381	24.0113-0189.1	413189
IVECO			8.282.191.000	03.3138-2010.3	010311	FTC3846	24.0114-0108.1	414108
1906039	13.0460-4955.2	604955	8.282.191.200	03.3138-2010.3	010311	FTC902	24.0124-0143.1	424143
1906350	03.0137-0300.2	650300	8.282.192.000	03.3134-0300.3	010308	GWC1821	24.3220-1112.3	020223
1906352	03.0137-0309.2	650309	8.282.192.200	03.3134-0300.3	010308	LR000750	11.8171-0008.1	990049
1906402	13.0460-2843.2	602843	KIA			LR000751	11.0101-5407.2	260011
1906416	13.0460-4914.2	604914	0K20A-33-25Z	11.0101-5407.2	260011	LR003977	11.8171-0008.1	990049
1907942	24.8190-2901.2	622901	0K20A-33-694	11.8171-0008.1	990049	NTC4991	24.2125-1710.3	010559
JAGUAR			0K20A-43-900A	03.0101-0014.2	320004	RTC4518	13.0460-6926.2	606926
C2C 24016	13.0460-4964.2	604964	0K30A-26-610	24.3217-1120.3	020360	RTC5574	13.0460-6925.2	606925
C2C 27297	11.8171-0008.1	990049	0K70Y-33-28Z	24.3217-1120.3	020360	RTC5756	13.0460-6922.2	606922
C2C 29161	11.0101-5407.2	260011	51712-M2000	13.0460-5806.2	605806	SDB000330	24.0114-0115.1	414115
C2C 8361	13.0460-4964.2	604964	58101-M2A02	24.0124-0136.1	424136	SDB100980	24.0114-0115.1	414115
CAC 4188	24.7718-7301.2	990024	58101-M2A04	13.0460-5933.2	605933	SFP000130	13.0460-6924.2	606924
DBC 6595	24.8190-1302.2	621302	K0BA2-33-28Z	13.0460-5933.2	605933	SFP000140	13.0460-6925.2	606925
JLM 10601	24.0110-0319.1	410319	KD001-33-29Z	13.0460-5944.2	605944	SFP000160	13.0460-6923.2	606923
JLM 11114	13.0460-7246.2	607246	KK150-26-38Z	13.0460-0451.2	610451	SFP000250	13.0460-6924.2	606924
JLM 11870	11.9481-9872.2	220682	KK150-33-23Z	03.0137-0204.2	650204	SFP000260	13.0460-6925.2	606925
JLM 11871	11.9481-9871.2	220681	KK150-33-251	13.0460-5970.2	605970	SFP000280	13.0460-6923.2	606923
JLM 12123	11.0441-6003.2	250037	KK150-33-28Z	24.0113-0165.1	413165	SML100070	24.3220-1112.3	020223
JLM 12124	11.0101-5407.2	260011	MDA01-26-251A	24.0113-0165.1	413165	STC1275	13.0460-6925.2	606925
JLM 12304	24.0128-0138.1	428138	MDA01-33-251	13.0460-5970.2	605970	STC1601	13.0460-6923.2	606923
JLM 12424	24.0110-0319.1	410319	MDX01-26-380	24.0217-0001.1	480198	STC2952	13.0460-6925.2	606925
JLM 12426	11.9481-9872.2	220682	MDX01-26-391	24.0113-0165.1	413165	STC3765	13.0460-6922.2	606922
JLM 12427	11.9481-9871.2	220681	LADA	03.0137-9113.2	669113	STC8568	13.0460-6926.2	606926
JLM 1305	24.0123-0108.1	423108	1118-3502070	03.0137-9113.2	669113	STC8570	13.0460-6917.2	606917
JLM 1826	24.0128-0138.1	428138	2101-1602510			STC8571	13.0460-6916.2	606916
JLM 1829	13.0460-7138.2	607138	2101-1602610	24.0220-0020.1	480059	STC8572	13.0460-6922.2	606922
JLM 1830	24.0110-0319.1	410319	2101-3103002	24.2519-0505.3	040070	STC8574	13.0460-0414.2	610414
JLM 1833	13.0460-7246.2	607246	2101-3501070	24.2419-1101.3	030085	STC9187	13.0460-6926.2	606926
JLM 20341	24.0128-0138.1	428138	2101-3501089	24.0111-0115.1	411115	STC9189	13.0460-6917.2	606917
JLM 20671	11.0441-4811.2	250024	2101-3501090	24.0111-0115.1	411115	STC9190	13.0460-6916.2	606916
JLM 20702	13.0460-7138.2	607138	2101-3502040	13.0460-2966.2	602966	STC9191	13.0460-6922.2	606922
JLM 21222	13.0460-7138.2	607138	2101-3502040-10	13.0460-2966.2	602966	SYG000030	11.8171-0008.1	990049
JLM 21495	11.0441-6007.2	250146	2101-3502090	24.3220-1102.3	020213	SZR000010	11.8116-0296.1	390445
JLM 2191	11.0441-6003.2	250037	2101-3502090-01	24.3220-1102.3	020213	LEXUS		
JLM 2194	11.0101-5407.2	260011	2101-3502090-80	03.0137-0232.2	650232	04466-60080	13.0460-5744.2	605744
JLM 2196	11.8116-0073.1	390498	2101-3505008	03.0137-0232.2	650232	04466-60090	13.0460-5744.2	605744
JLM 2200	11.0441-3602.2	250008	2101-3508180	03.0137-0232.2	650232	04466-60140	13.0460-5744.2	605744
JLM 2213	11.8171-0008.1	990049	2105-3502040	24.2119-0831.3	010416	MAGIRUS (KHD)		
JLM 2249	11.8171-0008.1	990049	2105-3502040	24.3727-2402.2	582402	0113-2430	83.6203-0250.3	330299
JLM 727	24.0124-0174.1	424174	2108-3502040	24.3220-1103.3	020214	0113-2431	83.6103-0320.3	330224
JLM 776	24.0124-0174.1	424174	2108-3502070	24.3220-1103.3	020214	0113-7292	83.6103-0300.3	330223
MJD 7868 AA	11.0441-6007.2	250146	2108-3502090	24.0220-0020.1	480059	0237-4448	03.2515-1101.3	040001
MJE 2001 AB	13.0460-7138.2	607138	2108-3501070	24.0112-0125.1	412125	0341-0834	83.6103-0320.3	330224
JEEP			2108-3501080	13.0460-2965.2	602965	0431-1134	03.3508-5951.3	310041
0 5015 965AA	24.0124-0702.1	424702	2108-3501089	13.0460-2965.2	602965	0431-4921	13.2601-8038.2	210170
0 5200 5000	24.0124-0702.1	424702	2108-3502070	24.0220-0020.1	480059	0431-4923	13.2601-8036.2	210168
0 5200 7710	24.0124-0702.1	424702	2108-3502090	03.0137-0231.2	650231	0431-4924	13.2601-8037.2	210169
0 5200 8264	24.0124-0702.1	424702	2108-3502090-80	03.0137-0231.2	650231	0431-6931	13.0441-5416.2	250117
0 5200 8440	24.0124-0702.1	424702	2108-3505010	24.2120-0803.3	010415	0431-7986	03.3508-8801.3	310050
5015 965AA	24.0124-0702.1	424702	2108-3506060	24.5127-0305.3	330578	0432-2292	13.0441-6001.2	250126
			2108-3508180	24.3727-2403.2	582403	0432-6387	03.3508-0401.3	310014
			21100-3501089	13.0460-2965.2	602965	0433-8428	13.0441-6010.2	250132
			2110-3501080	13.0460-2965.2	602965	0434-4643	13.0441-5416.2	250117

Vergleichsliste

Cross reference list - Tabella di conversione codici

Liste des correspondances - Lista referencias



MAGIRUS (KHD) 			MASERATI 			MAZDA 		
0437-3912	03.3508-8802.3	310051	327256318	11.8116-0091.1	390502	BCYW-33-23ZC	13.0460-5944.2	605944
0437-5656	13.0441-4018.2	250083	MAZDA			BF68-33-251A	24.0118-0101.1	418101
0625-9259	13.2481-8012.2	210093				BL53-26-38Z	03.0137-0183.2	650183
0625-9260	13.2481-8011.2	210092			BL78-26-43Z	13.0460-5824.2	605824	
1 1114 019 908.00	13.0441-5416.2	250117		24.0218-0024.2	480079	BL78-26-48Z	13.0460-5824.2	605824
1 2114 010 520.00	13.2481-8012.2	210093		24.0218-0724.2	480206	BP18-26-38Z	03.0137-0184.2	650184
1 2114 010 530.00	13.2481-8011.2	210092		24.0218-0024.2	480079	BP18-26-38Z-9A	03.0137-0184.2	650184
1 2114 019 901.00	13.0441-4825.2	250107		24.0218-0724.2	480206	BR70-33-25XA	24.0122-0166.1	422166
112 5468 E-8834-02	83.6123-0381.3	330262		24.0218-0024.2	480079	BR70-33-25XF	24.0122-0166.1	422166
113 2431 E 8834-02	83.6103-0320.3	330224		24.0218-0724.2	480206	BR74-26-251A	24.0109-0131.1	409131
127 1610 TY 8751-28	03.0370-1131.2	051131		24.0218-0724.2	480079	BR74-26-251E	24.0109-0131.1	409131
1-3112	83.6103-0450.3	330228		24.0218-0724.2	480206	BR74-33-25X	24.0122-0165.1	422165
1472-8701.31	83.6103-0400.3	330226		24.0218-0024.2	480079	BRY0-33-28Z	13.0460-5944.2	605944
2030-3706.05	03.3318-0800.2	390112		24.0218-0724.2	480206	BRY4-33-23Z	13.0460-5974.2	605974
237 4448 KZ 1210-30	03.2515-1101.3	040001		24.3217-1715.3	020463	BRY4-33-28Z	13.0460-5974.2	605974
237 4908 UA 1210-30	83.6203-0250.3	330299		13.0460-7073.2	607073	BSY6-26-38Z	03.0137-0239.2	650239
244 2720 ED 5075-52	03.2515-1101.3	040001		13.0460-7073.2	607073	BWYH-26-43Z	13.0460-5972.2	605972
246 8167 KZ 5082-28	03.3134-0300.3	010308		13.0460-7073.2	607073	CC29-44-150	24.3727-1812.2	581812
246 8233 KZ 5082-28	03.3138-2001.3	010310		24.0112-0141.1	412141	D061-26-380	03.0137-9186.2	669186
296 1029-5140-28	03.3318-0800.2	390112		24.0112-0141.1	412141	D102-26-251	24.0220-0026.1	480104
330 671 29	83.6103-0500.3	330230		11.3481-8514.2	220336	DA01-33-251	24.0113-0165.1	413165
342 3580 KZ 5081-28	03.3508-0264.3	310009		11.3481-8513.2	220335	DA15-26-38Z	03.0137-0204.2	650204
385 835 85	83.6103-0620.3	330234		24.3217-1715.3	020463	DA15-26-38ZA	03.0137-0204.2	650204
432 6387	03.3508-0401.3	310014		24.0112-0141.1	412141	DA19-33-28Z	13.0460-5970.2	605970
446 9763 KZ 5081-28	03.3508-5951.3	310041		24.3219-1107.3	020338	DA19-33-28ZA	13.0460-5970.2	605970
5112-5206.18	83.6103-0320.3	330224		13.0460-7071.2	607071	DB0Y-33-251	24.0112-0147.1	412147
5148-5203.05	03.3508-0401.3	310014		13.0460-7071.2	607071	DBY2-26-38Z	03.0137-0263.2	650263
5155-5211.10	03.2515-1101.3	040001		13.0460-7071.2	607071	DCY0-33-23ZA	13.0460-5944.2	605944
5156-2801.10	83.6103-0620.3	330234		11.3541-8530.2	220342	DCY0-33-23ZB	13.0460-5944.2	605944
5157-2810.90	03.3509-0100.3	310057		24.3541-8530.5	240554	DCY1-33-23Z	13.0460-5944.2	605944
5157-2812.160	83.6103-0190.3	330218		11.3541-8529.2	220341	DCY5-33-23Z	13.0460-5944.2	605944
5167-2812.01	83.6103-0600.3	330233		24.3541-8529.5	240553	DCY9-33-23Z	13.0460-5944.2	605944
5167-2812.07	83.6103-0450.3	330228		24.3219-1107.3	020338	DF71-26-610	24.3219-1752.3	020505
5167-2812.08	83.6103-0300.3	330223		24.0220-0029.1	480120	E0Y8-26-43ZA	13.0460-5972.2	605972
5167-2812.11	03.3138-2001.3	010310		24.3217-1703.3	020380	G030-49-280	13.0460-5934.2	605934
5177-2835.01	83.6103-0400.3	330226		13.0460-5974.2	605974	G030-49-280A	13.0460-5934.2	605934
8000-0604	24.2423-0905.3	030070		13.0460-5974.2	605974	G030-49-280B	13.0460-5934.2	605934
8602-8006	24.2423-0905.3	030070		24.0118-0101.1	418101	G211-33-28Z	13.0460-5932.2	605932
8602-8036	24.2423-0905.3	030070		24.3217-1703.3	020380	G311-26-251A	24.0110-0256.1	410256
8603-0915	24.2538-0901.3	040056		24.3217-1703.3	020380	GA5R-44-150B	24.3727-1812.2	581812
8751-2801.71	03.3318-0800.2	390112		24.3217-1703.3	020380	GA5R-44-150C	24.3727-1812.2	581812
8751-2890.220	03.2419-1451.3	030012		13.0460-5944.2	605944	GG29-49-280	13.0460-5934.2	605934
DIN 74225 EE 10	83.6203-0400.3	330302		24.3727-1810.2	581810	GJ21-26-251	24.0222-8028.1	480143
K 18 117	83.6103-0550.3	330231		24.3727-1811.2	581811	GJ21-26-251A	24.0222-8028.1	480143
S 18 921	83.6103-0650.3	330235		24.0109-0127.1	409127	GJ21-26-251B	24.0222-8028.1	480143
MAN				24.0109-0127.1	409127	GJ21-26-38Z	03.0137-0185.2	650185
38.91411.0170	03.3131-0102.3	010296		24.0109-0127.1	409127	GJ21-26-38ZA	24.3217-1120.3	020360
81.30716.6002	03.0450-2509.2	082509		13.0460-5944.2	605944	GJ21-26-610C	24.3217-1120.3	020360
81.31110.7000	03.3508-0264.3	310009		13.0460-5944.2	605944	GJ21-26-610D	13.0460-5932.2	605932
81.51130.6003	03.0370-1131.2	051131		24.0220-0026.1	480104	GJ21-33-28ZB	13.0460-5932.2	605932
81.51130.6006	03.3138-2001.3	010310		24.0220-0026.1	480104	GJ21-44-150	24.3727-1812.2	581812
81.51130.6017	03.3131-0601.3	010299		24.0220-0026.1	480104	GJ25-26-251	24.0110-0181.1	410181
81.51130.7000	03.3131-0601.3	010299		24.0220-0026.1	480104	GJ25-26-251A	24.0110-0181.1	410181
81.51133.0003	03.3318-0800.2	390112		03.0137-9182.2	669182	GJ25-26-251B	24.0110-0181.1	410181
81.51210.0029	83.6103-0260.3	330221		03.0137-9182.2	669182	GJ25-33-25XD	24.0124-0105.1	424105
81.51210.0030	83.6103-0650.3	330235		03.0137-0278.2	650278	GJ25-33-29Z	13.0460-0313.2	610313
81.51210.0031	83.6203-0260.3	330300		03.0137-0278.2	650278	GJ55-33-25XC	24.0124-0105.1	424105
81.51210.0036	83.6103-0800.3	330237		13.0460-5944.2	605944	GJ83-26-38Z	03.0137-0185.2	650185
81.51210.2001	83.6103-0550.3	330231		13.0460-5944.2	605944	GJ83-26-38ZA	03.0137-0185.2	650185
81.51210.5005	83.6103-0620.3	330234		13.0460-5944.2	605944	GJ87-26-48ZA	13.0460-5995.2	605995
81.51501.6001	03.3509-0600.3	310065		13.0460-5944.2	605944	GJY1-33-28Z	13.0460-5932.2	605932
81.51501.7004	03.3508-0501.3	310017		13.0460-5824.2	605824	GM09-26-251B	24.0110-0256.1	410256
81.96340.0045	83.6103-0500.3	330230		24.0109-0131.1	409131	GN51-33-23Z	13.0460-5932.2	605932
81.96340.0081	83.6103-0700.3	330236		24.0109-0131.1	409131	GN51-33-28Z	13.0460-5932.2	605932
81.96340.0103	83.6103-0450.3	330228		24.0109-0131.1	409131	GW55-26-251	24.0110-0181.1	410181
81.96340.0213	83.6103-0320.3	330224		24.0122-0165.1	422165	H266-26-48Z	13.0460-5625.2	605625
90.81051.8186	03.3150-0101.3	010321		24.0122-0165.1	422165	H266-26-48ZA	13.0460-5625.2	605625
90.81052.2203	03.3508-0401.3	310014		13.0460-5944.2	605944	HF39-26-48Z	13.0460-5625.2	605625
				03.0137-0278.2	650278	HF39-26-48ZA	13.0460-5625.2	605625
				03.0137-0278.2	650278	NA01-26-251A	24.0109-0127.1	409127
				13.0460-5944.2	605944	NA01-33-25X	24.0118-0113.1	418113



Vergleichsliste

Cross reference list - Tabella di conversione codici

Liste des correspondances - Lista referencias



MAZDA 			MERCEDES BENZ 			MERCEDES BENZ 		
NA01-33-25XA	24.0118-0113.1	418113	000 420 59 20	13.0460-9029.2	609029	000 421 71 86	13.0441-4214.2	250091
NA01-33-25XC	24.0118-0113.1	418113	000 420 59 83	24.3541-1725.5	240003	000 421 71 98	13.2571-9998.2	210133
NAY0-26-43Z	13.0460-5972.2	605972	000 420 60 20	13.0460-9029.2	609029	000 421 72 86	13.0441-3817.2	250071
S083-49-280	13.0460-5806.2	605806	000 420 60 83	24.3541-1726.5	240004	000 421 72 98	13.2571-9999.2	210134
S083-49-280A	13.0460-5806.2	605806	000 420 62 20	13.0460-3804.2	603804	000 421 73 98	13.2571-9998.2	210133
S231-49-280	13.0460-5806.2	605806	000 420 63 20	13.0460-9028.2	609028	000 421 74 98	13.2571-9999.2	210134
S231-49-280A	13.0460-5806.2	605806	000 420 64 20	13.0460-9028.2	609028	000 421 77 86	13.0441-3606.2	250147
SE96-33-28Z	13.0460-5806.2	605806	000 420 65 20	13.0460-9028.2	609028	000 421 78 86	13.0441-4216.2	250093
SF04-33-28Z	13.0460-5806.2	605806	000 420 66 20	13.0460-6027.2	606027	000 421 79 86	13.0441-4601.2	250099
TAY2-26-43Z	13.0460-5625.2	605625	000 420 67 18	03.3228-0502.3	020109	000 423 00 75	13.0471-5405.2	250136
TBY7-26-43Z	13.0460-5625.2	605625	000 420 67 20	13.0460-6027.2	606027	000 423 04 19	13.0471-5408.2	250138
			000 420 68 20	13.0460-9028.2	609028	000 423 11 42	13.8158-0020.1	990113
			000 420 71 20	13.0460-4036.2	604036	000 423 12 42	13.8158-0021.1	990114
			000 420 71 83	13.0441-4018.2	250083	000 423 13 71	13.0471-5407.2	250137
			000 420 76 20	13.0460-3804.2	603804	000 423 23 98	13.2381-8027.2	210033
			000 420 76 20	13.0460-4036.2	604036	000 423 24 98	13.2381-8028.2	210034
			000 420 79 83	24.9442-8003.5	230053	000 423 25 98	13.2381-8027.2	210033
			000 420 80 83	24.9442-8004.5	230054	000 423 26 98	13.2381-8028.2	210034
			000 420 82 83	24.9238-8033.5	230015	000 423 31 98	13.2381-8027.2	210033
			000 420 83 83	13.2381-8034.2	210223	000 423 32 98	13.2381-8028.2	210034
			000 420 83 83	24.9238-8034.5	230016	000 423 33 98	13.2381-8027.2	210033
			000 420 84 18	03.3222-0902.3	020068	000 423 34 98	13.2381-8028.2	210034
			000 420 87 83	13.2461-8001.2	210226	000 423 47 98	13.2381-8027.2	210033
			000 420 87 83	24.9246-8001.5	230021	000 423 48 98	13.2381-8028.2	210034
			000 420 88 20	13.0460-4030.2	604030	000 423 58 98	13.2381-8027.2	210033
			000 420 88 83	24.9246-8002.5	230022	000 423 59 98	13.2381-8028.2	210034
			000 420 89 20	13.0460-2923.2	602923	000 423 60 98	13.2381-8029.2	210035
			000 420 90 20	13.0460-4030.2	604030	000 423 61 98	13.2381-8030.2	210036
			000 420 90 83	24.9571-7005.5	230061	000 423 63 98	13.2381-8027.2	210033
			000 420 91 20	13.0460-2923.2	602923	000 423 64 98	13.2381-8028.2	210034
			000 420 91 83	24.9571-7006.5	230062	000 423 70 98	13.2381-8027.2	210033
			000 420 92 83	13.2401-8013.2	210051	000 423 71 98	13.2381-8028.2	210034
			000 420 92 83	24.9240-8013.5	230019	000 423 72 98	13.2381-8027.2	210033
			000 420 93 83	13.2401-8014.2	210052	000 423 73 98	13.2381-8028.2	210034
			000 420 93 83	24.9240-8014.5	230020	000 423 82 98	13.2381-8029.2	210035
			000 420 94 20	13.0460-9029.2	609029	000 423 83 98	13.2381-8030.2	210036
			000 420 95 20	13.0460-9029.2	609029	000 423 89 98	13.2421-8021.2	210057
			000 420 95 83	13.0441-4020.2	250084	000 423 89 98	24.9242-8021.5	230031
			000 420 97 20	13.0460-3990.2	603990	000 423 90 98	13.2421-8022.2	210058
			000 420 98 20	13.0460-4034.2	604034	000 423 90 98	24.9242-8022.5	230032
			000 420 99 20	13.0460-2927.2	602927	000 423 91 98	13.2381-8027.2	210033
			000 420 99 20	13.0470-2927.2	LD2927	000 423 92 98	13.2381-8028.2	210034
			000 420 99 83	13.0441-5721.2	250123	000 423 95 98	13.2353-8003.2	210016
			000 421 02 91	13.0460-0026.2	610026	000 423 96 98	13.2353-8004.2	210017
			000 421 08 18	11.8171-0008.1	990049	000 426 63 98	13.2381-8027.2	210033
			000 421 14 20	13.0460-0214.2	610214	000 428 01 35	83.6103-0450.3	330228
			000 421 23 91	13.0460-0131.2	610131	000 428 02 35	83.6103-0500.3	330230
			000 421 24 91	13.0460-0132.2	610132	000 428 07 35	83.6123-0381.3	330262
			000 421 24 98	13.2571-9998.2	210133	000 428 08 35	83.6103-0240.3	330220
			000 421 25 98	13.2571-9999.2	210134	000 428 14 35	83.6103-0650.3	330235
			000 421 28 91	13.0460-0158.2	610158	000 428 16 35	83.6103-0450.3	330228
			000 421 29 91	13.0460-0158.2	610158	000 428 26 35	83.6204-0240.3	330718
			000 421 30 88	13.0460-0158.2	610158	000 428 28 35	83.7704-0421.3	330827
			000 421 32 91	13.0460-0214.2	610214	000 428 29 35	83.7704-0320.3	330851
			000 421 34 88	13.0460-0160.2	610160	000 428 30 35	83.6104-0210.3	330473
			000 421 36 91	13.0460-0197.2	610197	000 428 31 35	83.6204-0220.3	330308
			000 421 39 91	13.0460-0219.2	610219	000 428 35 35	83.7704-0281.3	330804
			000 421 39 98	13.2571-9998.2	210133	000 428 38 35	83.6203-0250.3	330299
			000 421 40 94	13.2571-9999.2	210134	000 428 39 35	83.6203-0260.3	330300
			000 421 41 91	13.0460-0160.2	610160	000 428 40 35	83.6103-0320.3	330224
			000 421 41 98	13.2571-9998.2	210133	000 428 42 35	83.6103-0400.3	330226
			000 421 42 98	13.2571-9999.2	210134	000 428 43 35	83.6103-0600.3	330233
			000 421 43 98	13.2571-9998.2	210133	000 428 44 35	83.6103-0190.3	330218
			000 421 44 98	13.2571-9999.2	210134	000 428 45 35	83.6203-0200.3	330298
			000 421 46 86	11.0101-5403.2	260010	000 428 47 35	83.6103-0550.3	330231
			000 421 47 91	13.0460-0158.2	610158	000 428 48 35	83.6123-0381.3	330262
			000 421 52 91	13.0460-0239.2	610239	000 428 58 35	83.6204-0350.3	330382
			000 421 59 98	13.2571-9998.2	210133	000 428 67 35	83.6104-0440.3	330714
			000 421 60 98	13.2571-9999.2	210134	000 428 70 35	83.6203-0300.3	330386
			000 421 64 91	13.0460-0236.2	610236	000 428 71 35	24.5201-0220.3	331272
			000 421 64 91 64	13.0460-0236.2	610236	000 428 76 35	83.6133-0500.3	330272



Vergleichsliste

Cross reference list - Tabella di conversione codici

Liste des correspondances - Lista referencias



MERCEDES BENZ		MERCEDES BENZ		MERCEDES BENZ				
000 428 79 35	83.6104-0241.3	330731	001 295 14 06	24.2419-0901.3	030041	001 420 96 20	13.0460-2923.2	602923
000 428 80 35	83.7704-0421.3	330827	001 295 14 07	03.2523-1210.3	040021	001 420 98 20	13.0460-4201.2	604201
000 428 82 35	83.6133-0551.3	330273	001 295 15 06	24.2419-0937.3	030063	001 420 99 20	13.0460-9029.2	609029
000 428 89 35	83.6133-0651.3	330274	001 295 17 06	24.2419-0917.3	030047	001 421 29 98	13.2571-8013.2	210123
000 428 91 35	83.6133-0551.3	330273	001 295 24 06	24.2419-0932.3	030058	001 421 30 98	13.2571-8014.2	210124
000 428 93 35	83.6104-0220.3	330474	001 295 27 07	03.2523-1210.3	040021	001 421 36 98	24.9260-8025.5	230041
000 430 00 81	03.3318-0800.2	390112	001 295 29 06	03.2423-0603.3	030036	001 421 37 98	24.9260-8026.5	230042
000 430 03 81	03.3318-0800.2	390112	001 295 29 07	03.2523-1210.3	040021	001 421 47 98	13.2571-9998.2	210133
000 430 21 83	03.0370-3922.2	053922	001 295 30 06	24.2426-0902.3	030073	001 421 48 98	13.2571-9999.2	210134
000 430 47 02	03.3508-0264.3	310009	001 295 30 07	03.2523-1210.3	040021	001 421 51 98	13.2571-8013.2	210123
000 430 64 01	03.3125-0401.3	010290	001 295 38 06	24.2419-0942.3	030068	001 421 52 98	13.2571-8014.2	210124
000 430 72 01	03.3126-0503.3	010294	001 295 40 06	24.2419-0921.3	030050	001 421 73 98	13.2571-9998.2	210133
000 430 92 30	03.6850-0202.4	300043	001 295 43 06	24.2419-0942.3	030068	001 421 74 98	13.2571-9999.2	210134
000 430 95 30	03.6855-1202.4	300056	001 295 44 06	24.2419-0935.3	030061	001 421 77 98	24.9260-8025.5	230041
000 431 12 02	03.3508-3600.3	310030	001 295 44 06	24.2419-0936.3	030062	001 421 78 98	24.9260-8026.5	230042
000 431 13 02	03.3509-0100.3	310057	001 295 51 06	24.2419-0934.3	030060	001 421 79 98	13.2601-9996.2	210176
000 431 15 02	03.3508-0501.3	310017	001 295 52 06	24.2419-0932.3	030058	001 421 80 98	13.2601-9997.2	210177
000 431 16 02	03.3508-0401.3	310014	001 295 53 07	03.2538-0104.3	040035	001 421 81 98	13.2571-9998.2	210133
000 431 21 02	03.3508-0801.3	310023	001 295 54 07	24.2528-0907.3	040054	001 421 82 98	13.2571-9999.2	210134
000 431 24 02	03.3509-0600.3	310065	001 295 60 06	03.2423-0603.3	030036	001 421 86 98	24.9260-8025.5	230041
000 431 36 07	24.7718-7301.2	990024	001 295 61 07	03.2523-1210.3	040021	001 421 87 98	24.9260-8026.5	230042
000 431 47 02	03.3508-0264.3	310009	001 295 68 06	24.2419-0915.3	030045	001 421 98 98	13.4571-8005.3	210205
000 431 53 02	03.3508-4903.3	310032	001 295 68 07	03.2523-0811.3	040019	001 421 99 98	13.4571-8006.3	210206
000 431 64 02	03.3508-8753.3	310049	001 295 76 06	24.2419-0917.3	030047	001 423 46 98	13.2351-8005.2	210014
000 431 69 02	03.3508-0264.3	310009	001 295 79 06	24.2419-0917.3	030047	001 423 46 98	24.9235-8005.5	230023
000 431 70 12	03.6521-0012.3	320094	001 295 80 06	24.2419-0942.3	030068	001 423 47 98	13.2351-8006.2	210015
000 431 89 02	03.3508-8753.3	310049	001 295 86 06	24.2419-0917.3	030047	001 423 47 98	24.9235-8006.5	230024
000 540 02 17	24.8190-0401.2	620401	001 295 87 06	24.2419-0937.3	030063	001 428 02 35	83.6103-0300.3	330223
000 586 11 43	03.0370-1131.2	051131	001 295 88 07	03.2538-0104.3	040035	001 428 03 35	83.6104-0470.3	330253
000 586 13 43	13.0441-5718.2	250120	001 295 96 07	24.2528-0907.3	040054	001 428 04 35	24.5201-0220.3	331272
000 586 15 43	13.0441-4206.2	250087	001 420 01 20	13.0460-4030.2	604030	001 428 07 35	83.6203-0300.3	330386
000 586 21 29	03.0450-2311.2	082311	001 420 02 20	13.0460-3805.2	603805	001 428 09 35	83.6203-0250.3	330299
000 586 22 42	13.0460-4036.2	604036	001 420 02 20	13.0470-3805.2	LD3805	001 428 14 35	83.6204-0280.3	330732
000 586 25 42	13.0460-3804.2	603804	001 420 03 20	13.0460-4037.2	604037	001 428 17 35	24.5201-0220.3	331272
000 586 25 42	13.0460-4036.2	604036	001 420 04 18	03.3223-0102.3	020090	001 428 18 35	83.6103-0200.3	330219
000 586 27 88	03.0402-1128.2	060027	001 420 05 20	13.0460-9029.2	609029	001 428 21 35	83.6123-0465.3	330379
000 586 28 88	03.0402-1128.2	060027	001 420 06 20	13.0460-3804.2	603804	001 428 26 35	83.6103-0450.3	330228
000 586 29 29	03.0350-1926.2	071926	001 420 06 20	13.0460-4036.2	604036	001 428 48 35	83.6133-0651.3	330274
000 586 29 42	13.0460-6027.2	606027	001 420 06 83	13.2421-8025.2	210061	001 428 53 35	83.6123-0465.3	330379
000 586 31 29	03.0450-3801.2	083801	001 420 07 20	13.0460-2927.2	602927	001 428 54 35	83.6123-0465.3	330379
000 586 33 29	03.0450-2509.2	082509	001 420 07 20	13.0470-2927.2	LD2927	001 428 55 35	83.6133-0500.3	330272
000 586 37 42	13.0460-6027.2	606027	001 420 07 83	13.2421-8026.2	210062	001 428 87 35	83.6203-0250.3	330299
000 586 38 29	03.0450-2805.2	082805	001 420 08 20	13.0460-4037.2	604037	001 428 88 35	83.6104-0360.3	330475
000 586 39 29	03.0450-2311.2	082311	001 420 09 20	13.0460-6031.2	606031	001 428 94 35	83.7704-0421.3	330827
000 586 41 42	13.0460-4036.2	604036	001 420 10 20	13.0460-2923.2	602923	001 428 95 35	83.6204-0470.3	330312
000 586 46 29	03.0450-2510.2	082510	001 420 13 20	13.0460-3805.2	603805	001 430 36 30	03.6850-0202.4	300043
000 586 48 43	03.0370-1038.2	051038	001 420 13 20	13.0470-3805.2	LD3805	001 430 43 60	13.0441-6010.2	250132
000 586 48 43	03.0370-9998.2	059998	001 420 13 83	11.0101-5403.2	260010	001 430 48 01	03.3131-0601.3	010299
000 586 53 43	13.0441-3504.2	250050	001 420 14 20	13.0460-4401.2	604401	001 430 52 01	03.2123-0609.3	010171
000 586 64 42	13.0441-5718.2	250120	001 420 15 20	13.0460-6015.2	606015	001 430 63 01	03.2123-0609.3	010171
000 586 66 43	03.0370-3922.2	053922	001 420 18 83	24.3541-1603.5	240037	001 430 64 01	03.2123-0614.3	010172
000 586 72 42	13.0460-6027.2	606027	001 420 19 83	24.3541-1604.5	240038	001 430 66 30	03.6850-0202.4	300043
000 586 74 42	13.0441-6001.2	250126	001 420 23 83	11.0441-6007.2	250146	001 430 79 01	03.3138-2001.3	010310
000 586 75 42	13.0460-9028.2	609028	001 420 33 18	03.2728-2101.3	020008	001 430 81 01	03.2320-0201.3	010234
000 586 76 42	13.0460-3804.2	603804	001 420 34 18	03.2728-2201.3	020009	001 430 84 30	03.6855-1202.4	300056
000 586 76 42	13.0460-4036.2	604036	001 420 37 83	13.2421-8025.2	210061	001 430 89 01	03.2123-0614.3	010172
000 586 91 42	03.0402-1128.2	060027	001 420 38 83	13.2421-8026.2	210062	001 431 05 02	03.3508-0503.3	310018
000 991 03 60	13.0460-0026.2	610026	001 420 39 83	13.2461-8001.2	210226	001 431 06 02	03.3508-8753.3	310049
000 991 20 60	13.0460-0214.2	610214	001 420 39 83	24.9246-8001.5	230021	001 431 07 02	03.3508-8753.3	310049
000 991 32 60	13.0460-0158.2	610158	001 420 40 83	24.9246-8002.5	230022	001 431 08 12	03.6511-0030.3	320076
000 991 39 60	13.0460-0131.2	610131	001 420 75 20	13.0460-9029.2	609029	001 431 09 12	03.6511-0030.3	320076
000 991 40 60	13.0460-0132.2	610132	001 420 77 20	13.0460-6027.2	606027	001 431 39 12	03.6513-0340.3	320084
000 991 73 60	13.0460-0197.2	610197	001 420 78 20	13.0460-9028.2	609028	001 431 42 02	03.3508-8753.3	310049
000 991 98 60	13.0460-0219.2	610219	001 420 79 20	13.0460-4036.2	604036	001 431 45 02	03.3508-8753.3	310049
000 997 08 86	03.3304-0700.1	390082	001 420 81 20	13.0460-2923.2	602923	001 431 59 12	03.6515-0304.3	320241
000 997 50 30	03.3517-0101.2	390322	001 420 85 20	13.0460-4037.2	604037	001 431 69 12	03.6515-0305.3	320087
000 997 78 30	03.3517-0101.2	390322	001 420 92 20	13.0460-6031.2	606031	001 586 18 42	13.0460-9028.2	609028
001 295 02 06	24.2419-0942.3	030068	001 420 93 20	13.0460-3804.2	603804	001 586 19 42	13.0460-6027.2	606027
001 295 03 07	03.2538-0104.3	040035	001 420 93 20	13.0460-4036.2	604036	001 586 31 42	13.0460-6027.2	606027
001 295 11 06	24.2419-0917.3	030047	001 420 95 20	13.0460-3805.2	603805	001 586 32 42	13.0460-9028.2	609028
001 295 13 07	03.2523-1210.3	040021	001 420 95 20	13.0470-3805.2	LD3805	001 586 33 42	13.0460-9028.2	609028



Vergleichsliste

Cross reference list - Tabella di conversione codici



Liste des correspondances - Lista referencias

MERCEDES BENZ		MERCEDES BENZ		MERCEDES BENZ				
001 586 36 42	13.0460-9028.2	609028	002 430 44 30	03.6855-1202.4	300056	003 430 60 01	03.2023-0166.3	010015
001 586 37 42	03.0403-0341.2	060031	002 430 60 01	03.2122-2202.3	010140	003 430 78 01	03.2023-0166.3	010015
001 586 48 42	13.0441-5417.2	250118	002 430 64 01	03.2122-2202.3	010140	003 430 79 01	03.2123-6002.3	010184
001 586 53 42	13.0441-5721.2	250123	002 430 68 30	03.6855-1202.4	300056	003 430 82 01	03.2123-6002.3	010184
001 586 54 42	13.0441-5721.2	250123	002 430 84 01	03.3138-2001.3	010310	003 430 98 01	24.2123-0901.3	010382
001 586 64 42	13.0460-3804.2	603804	002 430 85 01	03.3134-0300.3	010308	003 430 99 01	03.2023-0166.3	010015
001 586 73 43	13.0441-3811.2	250067	002 430 86 01	03.2125-1102.3	010202	004 420 16 20	13.0460-4047.2	604047
001 991 16 60	13.0460-0239.2	610239	002 430 91 01	03.3138-2001.3	010310	004 420 16 20	13.0470-4047.2	LD4047
001 991 27 60	13.0460-0236.2	610236	002 430 92 01	03.3134-0300.3	010308	004 420 37 18	24.3223-1705.3	020418
001 991 27 60 64	13.0460-0236.2	610236	002 430 93 01	03.2123-3402.3	010181	004 420 41 83	13.2601-0145.2	210247
001 997 55 30	03.3517-5100.1	390326	002 430 99 30	03.6855-1402.4	300057	004 420 42 83	13.2601-0146.2	210248
002 295 04 07	03.2538-0104.3	040035	002 431 13 12	03.6513-0340.3	320084	004 420 43 83	13.2544-0019.2	210251
002 295 13 07	03.2523-0812.3	040020	002 586 17 42	13.0441-6010.2	250132	004 420 44 83	13.9571-0003.2	210277
002 420 00 20	13.0460-3504.2	603504	002 586 20 42	13.0460-6031.2	606031	004 420 45 83	13.9574-7005.2	210275
002 420 01 20	13.0460-3504.2	603504	002 586 44 42	13.0441-6003.2	250128	004 420 48 83	13.2544-0020.2	210252
002 420 03 20	13.0460-6036.2	606036	002 586 45 42	13.0460-9029.2	609029	004 420 49 83	13.9571-0004.2	210278
002 420 04 20	13.0460-9033.2	609033	002 586 46 42	13.0460-9029.2	609029	004 420 50 83	13.9574-7006.2	210276
002 420 05 20	13.0460-4047.2	604047	002 586 47 42	13.0460-3804.2	603804	004 420 62 18	03.3222-5804.3	020083
002 420 05 20	13.0470-4047.2	LD4047	002 586 47 42	13.0460-4036.2	604036	004 420 81 83	13.9441-0041.2	210279
002 420 08 18	03.3220-0905.3	020059	002 586 48 42	13.0460-3804.2	603804	004 420 82 83	13.9441-0042.2	210280
002 420 12 20	13.0460-9033.2	609033	002 586 48 42	13.0460-4036.2	604036	004 421 78 98	13.4441-8013.2	210261
002 420 15 20	13.0460-4201.2	604201	002 586 53 42	13.0441-4408.2	250096	004 421 79 98	13.4441-8014.2	210262
002 420 16 20	13.0460-4047.2	604047	003 420 03 18	03.3220-0905.3	020059	004 421 82 98	13.4441-8015.2	210263
002 420 16 20	13.0470-4047.2	LD4047	003 420 04 18	03.3222-4007.3	020074	004 421 83 98	13.4441-8016.2	210264
002 420 19 20	13.0460-4202.2	604202	003 420 14 20	03.0137-4001.2	654001	004 430 08 30	03.7760-2702.4	300090
002 420 23 20	13.0460-2927.2	602927	003 420 15 20	13.0460-6015.2	606015	004 430 09 01	03.2023-0166.3	010015
002 420 23 20	13.0470-2927.2	LD2927	003 420 20 83	13.2601-8035.2	210167	004 430 12 01	24.2123-0901.3	010382
002 420 26 20	13.0460-9033.2	609033	003 420 24 20	13.0460-3990.2	603990	004 430 17 01	24.2022-1601.3	010340
002 420 37 20	13.0460-4202.2	604202	003 420 30 20	13.0460-4047.2	604047	004 430 22 01	03.2126-0512.3	010217
002 420 46 20	13.0460-4047.2	604047	003 420 30 20	13.0470-4047.2	LD4047	004 430 23 01	03.2023-0166.3	010015
002 420 46 20	13.0470-4047.2	LD4047	003 420 33 83	13.2601-8036.2	210168	004 430 24 01	24.2022-1601.3	010340
002 420 49 18	03.3219-3401.3	020049	003 420 34 20	03.0137-4001.2	654001	004 430 25 01	03.2023-0166.3	010015
002 420 57 20	13.0460-6015.2	606015	003 420 34 83	13.2601-8037.2	210169	004 430 26 01	03.2025-0111.3	010033
002 420 58 20	03.0137-4001.2	654001	003 420 35 83	13.2601-8038.2	210170	004 430 28 01	03.2125-1902.3	010206
002 420 81 18	03.3241-1801.3	020130	003 420 36 20	13.0460-6031.2	606031	004 430 29 01	03.2125-2102.3	010207
002 420 88 18	03.3222-5804.3	020083	003 420 44 20	13.0460-6015.2	606015	004 430 30 01	03.2123-6002.3	010184
002 421 00 98	13.9574-7005.2	210275	003 420 48 20	13.0460-4047.2	604047	004 430 31 30	03.7760-2702.4	300090
002 421 01 98	13.9574-7006.2	210276	003 420 48 20	13.0470-4047.2	LD4047	004 430 33 01	03.2023-0230.3	010019
002 421 05 98	24.9260-8029.5	230043	003 420 49 20	13.0460-4047.2	604047	004 430 34 01	03.2023-0825.3	010028
002 421 06 98	24.9260-8030.5	230044	003 420 49 20	13.0470-4047.2	LD4047	004 430 35 30	03.7760-2702.4	300090
002 421 18 98	24.9260-8025.5	230041	003 420 74 20	13.0460-6031.2	606031	004 430 38 01	03.2025-0211.3	010034
002 421 19 98	24.9260-8026.5	230042	003 420 77 20	13.0460-6015.2	606015	004 430 39 01	03.2023-0825.3	010028
002 421 23 98	24.9260-8025.5	230041	003 420 77 20 10	13.0460-6015.2	606015	004 430 48 01	24.2133-0901.3	010387
002 421 24 98	24.9260-8026.5	230042	003 421 00 98	24.9260-8029.5	230043	004 430 50 01	03.2130-0102.3	010221
002 421 28 98	13.2601-8027.2	210159	003 421 01 98	24.9260-8030.5	230044	004 430 53 01	03.2130-0102.3	010221
002 421 29 98	13.2601-8028.2	210160	003 421 06 98	24.9260-8029.5	230043	004 430 54 01	03.2123-0522.3	010168
002 421 30 98	24.9260-8029.5	230043	003 421 07 98	24.9260-8030.5	230044	004 430 55 01	03.2025-0211.3	010034
002 421 31 98	24.9260-8030.5	230044	003 421 10 98	24.9260-8031.5	230045	004 430 75 01	03.2025-0211.3	010034
002 421 38 98	13.4441-8015.2	210263	003 421 11 98	24.9260-8032.5	230046	005 420 17 20	13.0460-3805.2	603805
002 421 39 98	13.4441-8016.2	210264	003 421 24 98	13.2601-8034.2	210166	005 420 17 20	13.0470-3805.2	LD3805
002 421 40 98	13.4441-8013.2	210261	003 421 25 98	13.2601-8033.2	210165	005 420 78 18	03.3222-7802.3	020088
002 421 41 98	13.4441-8014.2	210262	003 421 39 98	13.4441-8013.2	210261	005 420 79 18	24.3223-1705.3	020418
002 421 54 98	13.2571-8011.2	210121	003 421 40 98	13.4441-8014.2	210262	005 420 81 18	24.3215-0902.3	020153
002 421 55 98	13.2571-8012.2	210122	003 421 41 98	13.4441-8015.2	210263	005 420 98 20	13.0460-4401.2	604401
002 421 56 98	13.2571-8013.2	210123	003 421 42 98	13.4441-8016.2	210264	005 430 24 01	03.2023-0825.3	010028
002 421 57 98	13.2571-8014.2	210124	003 421 43 98	13.4441-8015.2	210263	005 430 26 01	03.2023-0230.3	010019
002 423 11 98	13.9544-0022.2	210258	003 421 44 98	13.4441-8016.2	210264	005 430 54 01	03.2026-0512.3	010038
002 423 12 98	13.9544-0021.2	210257	003 421 45 98	13.4441-8013.2	210261	005 430 55 01	03.2026-0462.3	010728
002 423 94 98	13.2421-8025.2	210061	003 421 46 98	13.4441-8014.2	210262	005 430 59 01	24.2022-1601.3	010340
002 423 95 98	13.2421-8026.2	210062	003 421 47 98	13.4441-8013.2	210261	005 430 69 01	03.2026-0462.3	010728
002 428 05 35	83.6133-0500.3	330272	003 421 48 98	13.4441-8014.2	210262	005 586 72 42	13.0460-6027.2	606027
002 428 20 35	83.6203-0250.3	330299	003 421 49 98	13.4441-8015.2	210263	006 420 15 18	03.2524-0400.3	040024
002 428 57 35	24.5201-0220.3	331272	003 421 50 98	13.4441-8016.2	210264	006 421 21 98	13.4441-8013.2	210261
002 428 58 35	83.6203-0250.3	330299	003 430 04 01	03.2122-4902.3	010144	006 421 22 98	13.4441-8014.2	210262
002 430 02 30	03.6850-2602.4	300049	003 430 06 01	03.2125-1302.3	010203	006 421 23 98	13.4441-8013.2	210261
002 430 14 01	03.3134-0300.3	010308	003 430 06 30	03.6855-1902.4	300059	006 421 24 98	13.4441-8014.2	210262
002 430 21 01	03.3138-2001.3	010310	003 430 07 01	03.2125-1102.3	010202	006 421 29 98	13.4441-8015.2	210263
002 430 22 01	03.3134-0300.3	010308	003 430 15 30	03.7760-2702.4	300090	006 421 30 98	13.4441-8016.2	210264
002 430 28 01	03.2123-1003.3	010175	003 430 22 01	03.2123-1003.3	010175	007 420 09 18	24.3217-1109.3	020173
002 430 36 01	03.3138-2001.3	010310	003 430 24 30	03.7760-2702.4	300090	007 420 21 18	03.2524-0400.3	040024
002 430 41 01	03.3134-0300.3	010308	003 430 34 30	03.6855-2202.4	300061	007 421 03 98	13.2601-7015.2	210230

Vergleichsliste

Cross reference list - Tabella di conversione codici

Liste des correspondances - Lista referencias



MERCEDES BENZ		MERCEDES BENZ		MERCEDES BENZ	
007 421 04 98	13.2601-8037.2	210169	123 428 06 35	24.5101-0346.3	331406
007 421 05 98	13.2601-7016.2	210231	123 540 00 17	24.8190-0401.2	620401
007 421 06 98	13.2601-8038.2	210170	124 420 00 83	13.2381-8035.2	210037
007 421 15 98	13.4441-8015.2	210263	124 420 00 83	24.9238-8035.5	230025
007 421 16 98	13.4441-8016.2	210264	124 420 01 48	83.6154-0526.3	330285
008 420 24 18	24.3222-1732.3	020537	124 420 01 83	24.9238-8036.5	230026
008 420 42 18	24.3215-0902.3	020153	124 420 02 83	13.2351-8005.2	210014
008 420 43 18	24.3217-1109.3	020173	124 420 02 83	24.9235-8005.5	230023
008 420 44 18	24.3222-1732.3	020537	124 420 03 20	03.0137-0170.2	650170
009 420 11 18	24.3222-1732.3	020537	124 420 03 83	13.2351-8006.2	210015
009 420 15 18	24.3244-0904.3	020301	124 420 03 83	24.9235-8006.5	230024
009 420 18 18	24.3244-0904.3	020301	124 420 05 20	03.0137-0170.2	650170
009 420 82 18	03.3222-5804.3	020083	124 420 07 20	03.0137-0170.2	650170
009 420 83 18	03.3222-7802.3	020088	124 420 10 85	24.3727-0411.2	580411
009 420 84 18	24.3223-1705.3	020418	124 420 11 85	24.3727-0409.2	580409
010 420 08 18	24.3244-0904.3	020301	124 420 26 85	24.3727-0411.2	580411
011 420 00 18	24.3222-1732.3	020537	124 421 00 71	13.8190-0242.1	990124
011 420 01 18	24.3222-1732.3	020537	124 421 01 71	13.8190-0330.1	990134
011 420 16 18	24.3244-0904.3	020301	124 421 05 71	13.8190-0330.1	990134
011 420 88 18	24.3217-1109.3	020173	124 421 13 12	24.0112-0117.1	412117
107 420 00 83	13.2601-8034.2	210166	124 421 14 12	24.0122-0134.1	422134
107 420 01 83	13.2601-8033.2	210165	124 421 15 12	24.0122-0136.1	422136
107 420 02 83	13.2601-8027.2	210159	124 421 16 12	24.0122-0123.1	422123
107 420 03 83	13.2601-8028.2	210160	124 421 23 12	24.0122-0134.1	422134
107 420 04 83	24.9440-8027.5	230051	124 421 24 12	24.0125-0107.1	425107
107 420 05 83	24.9440-8028.5	230052	124 421 26 12	24.0128-0103.1	428103
110 420 00 72	24.0113-0111.1	413111	124 421 27 12	24.0122-0123.1	422123
110 421 01 12	24.0113-0111.1	413111	124 423 05 12	24.0109-0114.1	409114
115 290 01 15	03.3508-1706.3	310024	124 423 05 12	24.0309-0114.1	509114
115 420 00 72	24.0110-0185.1	410185	124 423 06 12	24.0120-0199.1	420199
115 420 01 72	24.0113-0112.1	413112	124 423 08 12	24.0124-0188.1	424188
115 420 02 72	24.0113-0113.1	413113	124 423 10 12	24.0120-0199.1	420199
115 420 16 85	24.3727-0406.2	580406	126 420 00 05	24.0122-0116.1	422116
115 420 20 85	24.3727-0407.2	580407	126 420 00 83	24.9260-8031.5	230045
115 420 26 85	24.3727-0407.2	580407	126 420 01 20	03.0137-0128.2	650128
115 420 27 85	24.3727-0407.2	580407	126 420 01 20	03.0137-0171.2	650171
115 421 11 12	24.0113-0112.1	413112	126 420 01 72	24.0122-0116.1	422116
115 421 13 12	24.0113-0113.1	413113	126 420 01 83	24.9260-8032.5	230046
115 423 02 12	24.0110-0185.1	410185	126 420 04 83	13.2381-8029.2	210035
115 423 04 12	24.0110-0185.1	410185	126 420 05 83	13.2381-8030.2	210036
116 420 00 83	24.9260-8025.5	230041	126 420 06 83	13.2571-8023.2	210127
116 420 01 72	24.0122-0106.1	422106	126 420 07 83	13.2571-8024.2	210128
116 420 01 83	24.9260-8026.5	230042	126 420 16 85	24.3727-0416.2	580416
116 420 02 05	24.0122-0106.1	422106	126 420 17 85	24.3727-0417.2	580417
116 428 01 35	83.6204-0280.3	330732	126 421 00 12	24.0122-0116.1	422116
123 420 00 72	24.0113-0137.1	413137	126 421 04 12	24.0128-0102.1	428102
123 420 01 20	03.0137-0128.2	650128	126 421 05 12	24.0128-0102.1	428102
123 420 01 83	24.9260-8029.5	230043	126 423 00 12	24.0110-0185.1	410185
123 420 02 83	24.9260-8030.5	230044	126 428 01 35	83.6204-0282.3	330309
123 420 02 85	24.3727-0403.2	580403	126 428 03 35	83.7704-0281.3	330804
123 420 03 83	24.9260-8029.5	230043	126 540 20 17	24.8190-0401.2	620401
123 420 04 83	24.9260-8030.5	230044	126 997 02 32	03.3517-5100.1	390326
123 420 04 85	24.3727-0401.2	580401	129 420 00 83	24.9442-8003.5	230053
123 420 05 83	13.2381-8027.2	210033	129 420 01 83	24.9442-8004.5	230054
123 420 05 85	24.3727-0402.2	580402	129 420 02 83	13.2381-8035.2	210037
123 420 06 83	13.2381-8028.2	210034	129 420 02 83	24.9238-8035.5	230025
123 420 07 83	13.2381-8027.2	210033	129 420 03 83	24.9238-8036.5	230026
123 420 08 83	13.2381-8028.2	210034	129 420 08 85	24.3727-0468.2	580468
123 420 09 83	13.2381-8027.2	210033	129 420 09 85	24.3727-0469.2	580469
123 420 10 83	13.2381-8028.2	210034	129 420 26 85	24.3727-0464.2	580464
123 420 11 83	13.2421-8021.2	210057	129 420 27 85	24.3727-0464.2	580464
123 420 11 83	24.9242-8021.5	230031	129 421 03 12	24.0122-0123.1	422123
123 420 12 83	13.2421-8022.2	210058	129 421 06 12	24.0128-0103.1	428103
123 420 12 83	24.9242-8022.5	230032	129 421 10 12	24.0128-0103.1	428103
123 420 14 83	13.2381-8027.2	210033	129 421 15 12	24.0130-0121.1	430121
123 420 15 83	13.2381-8028.2	210034	129 421 16 12	24.0130-0122.1	430122
123 421 00 12	24.0113-0137.1	413137	129 421 17 12	24.0130-0121.1	430121
123 428 01 35	83.7704-0281.3	330804	129 421 18 12	24.0130-0122.1	430122
123 428 02 35	83.6104-0360.3	330475	129 421 20 12	24.0128-0103.1	428103
123 428 03 35	83.7704-0421.3	330827	129 423 00 12	24.0109-0103.1	409103
123 428 05 35	83.7704-0421.3	330827	129 423 03 12	24.0122-0218.1	422118



Vergleichsliste

Cross reference list - Tabella di conversione codici

Liste des correspondances - Lista referencias



MERCEDES BENZ 			MERCEDES BENZ 			MERCEDES BENZ 		
405 421 03 98	13.2544-0020.2	210252	440 421 00 98	13.2601-8035.2	210167	667 420 35 01	13.4441-8013.2	210261
405 421 06 98	13.2544-0019.2	210251	440 421 01 98	13.2601-8036.2	210168	667 420 36 01	13.4441-8014.2	210262
405 421 07 98	13.2544-0020.2	210252	440 421 02 98	13.2601-8037.2	210169	667 420 47 01	13.4441-8017.2	210265
415 423 00 23	03.0137-9228.2	669228	440 421 03 98	13.2601-8038.2	210170	667 420 48 01	13.4441-8018.2	210266
416 421 00 98	13.2601-8035.2	210167	460 295 00 06	24.2419-0942.3	030068	667 428 01 35	83.6104-0470.3	330253
416 421 01 98	13.2601-8037.2	210169	460 420 00 20	13.0460-4401.2	604401	668 420 01 18	03.3230-0401.3	020115
416 421 02 98	13.9544-0022.2	210258	460 420 50 48	24.5224-0460.3	331264	668 420 02 18	03.3230-0401.3	020115
416 421 03 98	13.9544-0021.2	210257	460 421 00 12	24.0116-0133.1	416133	668 420 03 18	03.3230-0401.3	020115
416 421 04 98	13.2601-8038.2	210170	460 428 51 35	24.5165-0450.3	331259	668 421 01 12	24.0130-0198.1	430198
416 421 05 98	13.2601-8036.2	210168	460 428 54 35	24.5224-0460.3	331264	668 421 02 12	24.0130-0103.1	430103
416 421 06 98	13.9544-0022.2	210258	460 540 06 17	24.8190-0406.2	620406	668 421 06 12	24.0130-0198.1	430198
416 421 07 98	13.9544-0021.2	210257	461 420 07 02	13.9441-0041.2	210279	669 420 00 20	13.0460-6015.2	606015
418 421 01 98	13.2544-0019.2	210251	461 420 08 02	13.9441-0042.2	210280	669 420 01 20	13.0460-6015.2	606015
418 421 02 98	13.2544-0020.2	210252	461 421 00 12	24.0116-0133.1	416133	669 421 01 12	24.0130-0198.1	430198
418 421 15 98	13.2601-0145.2	210247	463 420 50 85	24.3727-0477.2	580477	669 421 06 12	24.0130-0198.1	430198
418 421 16 98	13.2601-0146.2	210248	463 420 51 85	24.3727-0476.2	580476	669 540 04 17	24.8190-0415.2	620415
419 421 00 98	13.2601-8035.2	210167	463 421 00 12	24.0130-0217.1	430217	669 540 05 17	24.8190-0415.2	620415
419 421 01 98	13.2601-8037.2	210169	463 421 01 12	24.0130-0217.1	430217	669 540 06 17	24.8190-0415.2	620415
419 421 02 98	13.2601-8036.2	210168	463 421 03 12	24.0130-0217.1	430217	670 420 01 18	03.3231-3401.3	020120
419 421 03 98	13.2601-8038.2	210170	601 420 00 72	24.0116-0100.1	416100	670 420 02 18	03.3231-3401.3	020120
419 421 04 98	13.9544-0022.2	210258	601 420 01 72	24.0122-0140.1	422140	670 420 03 18	03.3231-3401.3	020120
419 421 05 98	13.9544-0021.2	210257	601 420 02 72	24.0116-0100.1	416100	670 420 28 20	13.0460-6015.2	606015
419 421 06 98	13.2601-8035.2	210167	601 420 03 72	24.0122-0140.1	422140	670 421 01 12	24.0130-0103.1	430103
419 421 07 98	13.2601-8036.2	210168	601 420 11 85	24.3727-0420.2	580420	670 421 03 12	24.0130-0103.1	430103
419 421 08 98	13.2601-8037.2	210169	601 420 33 85	24.3727-0459.2	580459	901 420 01 20	03.0137-4001.2	654001
419 421 09 98	13.2601-8038.2	210170	601 420 34 85	24.3727-0460.2	580460	901 420 03 20	03.0137-4001.2	654001
419 421 10 98	13.9544-0021.2	210257	601 420 36 85	24.3727-0459.2	580459	901 420 05 20	03.0137-4001.2	654001
419 421 11 98	13.9544-0022.2	210258	601 420 37 85	24.3727-0460.2	580460	901 540 00 17	24.8190-0407.2	620407
427 421 00 98	13.2601-8035.2	210167	601 420 46 85	24.3727-0459.2	580459	901 540 01 17	24.8190-0407.2	620407
427 421 01 98	13.2601-8037.2	210169	601 420 47 85	24.3727-0460.2	580460	902 423 01 12	24.0116-0110.1	416110
427 421 02 98	13.2601-8036.2	210168	601 420 76 20	13.0460-4401.2	604401	902 423 03 12	24.0116-0110.1	416110
427 421 03 98	13.2601-8038.2	210170	601 420 87 20	13.0460-4401.2	604401	902 423 04 12	24.0116-0110.1	416110
427 421 04 98	13.9544-0022.2	210258	601 421 03 12	24.0122-0140.1	422140	902 423 05 12	24.0116-0110.1	416110
427 421 05 98	13.9544-0021.2	210257	601 421 04 12	24.0116-0100.1	416100	905 420 00 20	13.0460-6015.2	606015
427 421 17 98	13.9574-7005.2	210275	601 421 05 12	24.0122-0140.1	422140			
427 421 18 98	13.9574-7006.2	210276	601 421 50 12	24.0116-0100.1	416100			
427 421 19 98	13.2601-8035.2	210167	601 421 51 12	24.0116-0100.1	416100	MG ROVER		
427 421 20 98	13.2601-8036.2	210168	601 423 50 01	24.0226-0001.1	480050	SFP000080	13.0460-5929.2	605929
427 421 21 98	13.2601-8037.2	210169	601 423 51 01	24.0223-0009.1	480039	SFP100520	13.0460-3605.2	603605
427 421 22 98	13.2601-8038.2	210170	601 586 00 42	13.0460-4401.2	604401	SFP100520	13.0470-3605.2	LD3605
427 421 23 98	13.9544-0021.2	210257	603 420 00 18	24.3222-1733.3	020538	SXS100000	03.0137-9701.2	669701
427 421 24 98	13.9544-0022.2	210258	608 420 03 18	03.3222-4401.3	020076			
435 421 04 98	13.9544-0021.2	210257	608 428 00 35	83.6123-0465.3	330379			
435 421 05 98	13.9544-0022.2	210258	608 428 01 35	83.6203-0200.3	330298			
435 421 12 98	13.2601-7015.2	210230	608 430 07 01	03.2123-3302.3	010180	34 11 0 141 338	11.0101-5402.2	260009
435 421 13 98	13.2601-7016.2	210231	608 431 00 49	03.3304-0700.1	390082	34 11 0 141 349	11.8171-0008.1	990049
435 421 14 98	13.2601-8037.2	210169	631 290 00 12	24.2419-1729.3	030118			
435 421 15 98	13.2601-8038.2	210170	631 420 00 18	24.3225-1102.3	020318			
435 542 00 17	24.8190-0403.2	620403	631 420 00 82	13.0460-0918.2	610918	MINI		
437 421 01 98	13.4571-8005.3	210205	631 420 01 20	13.0460-3945.2	603945			
437 421 02 98	13.4571-8006.3	210206	631 420 03 20	13.0460-3945.2	603945	4605A458	13.0460-5744.2	605744
437 421 04 98	13.9574-7005.2	210275	631 420 03 72	24.0116-0107.2	416107	4605A492	13.0460-5958.2	605958
437 421 05 98	13.9574-7006.2	210276	631 420 04 83	24.3481-1759.5	240339	MB058553	24.3219-1716.3	020071
437 421 07 98	13.4571-8005.3	210205	631 420 05 83	24.3481-1759.5	240339	MB150810	24.0120-0139.1	420139
437 421 08 98	13.4571-8006.3	210206	631 420 10 83	24.3481-1759.5	240339	MB151387	24.0120-0130.1	420130
437 421 10 98	13.9574-7005.2	210275	631 420 11 83	24.3481-1759.5	240339	MB193411	24.3219-1716.3	020071
437 421 11 98	13.9574-7006.2	210276	631 420 12 85	24.3727-0415.2	580415	MB238076	24.0113-0159.1	413159
437 421 12 98	13.9571-0003.2	210277	631 420 19 85	24.3727-0414.2	580414	MB238114	03.0137-0188.2	650188
437 421 13 98	13.9571-0004.2	210278	631 420 20 85	24.3727-0413.2	580413	MB238495	24.0120-0139.1	420139
437 421 14 98	13.9574-7005.2	210275	631 420 21 85	24.3727-0415.2	580415	MB238520	03.0137-0188.2	650188
437 421 15 98	13.9574-7006.2	210276	631 420 32 83	24.3481-1759.5	240339	MB238521	03.0137-0188.2	650188
437 421 16 98	13.9571-0003.2	210277	631 420 33 83	24.3481-1759.5	240339	MB238523	03.0137-0188.2	650188
437 421 17 98	13.9571-0004.2	210278	631 423 00 01	24.0225-4003.1	480049	MB238615	24.0118-0109.1	418109
437 421 18 98	13.9574-7005.2	210275	631 423 00 07	03.0137-0245.2	650245	MB316529	24.0220-3018.2	480121
437 421 19 98	13.9574-7006.2	210276	631 423 00 88	03.0137-9145.2	669145	MB316558	24.0220-3018.2	480121
437 421 20 98	13.2601-0146.2	210248	631 423 01 07	03.0137-0245.2	650245	MB316676	24.0113-0159.1	413159
437 421 21 98	13.2601-0145.2	210247	631 428 00 35	24.5232-0388.3	330580	MB316677	24.0118-0109.1	418109
437 421 22 98	13.2544-0019.2	210251	631 430 11 01	24.2125-1719.3	010666	MB366080	24.0124-0114.1	424114
437 421 23 98	13.2544-0020.2	210252	667 290 02 12	24.2419-0933.3	030059	MB366434	24.0118-0109.1	418109
437 421 25 98	13.2544-0019.2	210251	667 420 31 01	13.4441-8013.2	210261	MB366443	03.0137-0216.2	650216
437 421 26 98	13.2544-0020.2	210252	667 420 32 01	13.4441-8014.2	210262	MB366444	03.0137-0216.2	650216



Vergleichsliste

Cross reference list - Tabella di conversione codici

Liste des correspondances - Lista referencias

MITSUBISHI 			MITSUBISHI 			NISSAN 		
MB366445	03.0137-0216.2	650216	MB858400	13.0460-5958.2	605958	40206-00QAA	24.0121-0106.1	421106
MB366446	03.0137-0216.2	650216	MB858404	24.3431-1705.5	240365	40206-00QAJ	24.0120-0125.1	420125
MB407030	24.0122-0155.1	422155	MB858405	24.3431-1706.5	240366	40206-01B00	24.0112-0121.1	412121
MB407038	24.0122-0175.1	422175	MB858583	13.0460-5952.2	605952	40206-01B01	24.0112-0121.1	412121
MB407039	24.0122-0175.1	422175	MB858665	03.0137-0255.2	650255	40206-04C01	24.0122-0167.1	422167
MB407639	24.0124-0136.1	424136	MB858666	03.0137-0216.2	650216	40206-05A00	24.0112-0115.1	412115
MB500555	24.0110-0238.1	410238	MB858667	03.0137-0216.2	650216	40206-05A01	24.0112-0115.1	412115
MB500556	24.0110-0238.1	410238	MB858668	03.0137-0216.2	650216	40206-0F000	24.0126-0109.1	426109
MB500807	13.0460-0335.2	610335	MB858669	03.0137-0216.2	650216	40206-0F001	24.0126-0109.1	426109
MB500813	13.0460-5940.2	605940	MB858684	03.0137-0255.2	650255	40206-10W00	24.0122-0180.1	422180
MB500816	13.0460-5940.2	605940	MB858685	03.0137-0255.2	650255	40206-10W01	24.0122-0180.1	422180
MB500819	13.0460-5940.2	605940	MB858686	03.0137-0255.2	650255	40206-15E00	24.0122-0129.1	422129
MB500968	24.0124-0114.1	424114	MB858799	24.0124-0144.1	424144	40206-15E01	24.0122-0129.1	422129
MB500969	24.0124-0114.1	424114	MB895072	13.0460-5952.2	605952	40206-21B01	24.0112-0139.1	412139
MB515996	24.0220-3018.2	480121	MB895250	13.0460-5958.2	605958	40206-27B01	24.0115-0106.1	415106
MB534318	24.3571-1737.5	240387	MB928067	13.0460-5980.2	605980	40206-2F500	24.0122-0179.1	422179
MB534319	24.3571-1738.5	240388	MB928314	13.0460-5826.2	605826	40206-2F501	24.0122-0179.1	422179
MB534594	03.0137-0216.2	650216	MB928697	24.0124-0140.1	424140	40206-2L903	24.0122-0174.1	422174
MB534595	03.0137-0216.2	650216	MB928816	13.0460-5953.2	605953	40206-31G00	24.0126-0109.1	426109
MB534596	03.0137-0216.2	650216	MB928817	13.0460-5953.2	605953	40206-31G01	24.0126-0109.1	426109
MB534597	03.0137-0216.2	650216	MB928995	24.0124-0136.1	424136	40206-35G00	24.0122-0180.1	422180
MB534653	13.0460-5980.2	605980	MB950064	03.0137-0289.2	650289	40206-35G01	24.0122-0180.1	422180
MB587432	24.0110-0243.1	410243	MB950065	03.0137-0288.2	650288	40206-37J01	24.0120-0119.1	420119
MB587433	24.0110-0243.1	410243	MB950176	24.3431-1701.5	240437	40206-54C01	24.0126-0112.1	426112
MB58758	24.0220-3017.1	480108	MB950177	24.3431-1702.5	240438	40206-55F01	24.0122-0179.1	422179
MB587659	03.0137-0188.2	650188	MB950211	03.0137-0452.2	650452	40206-55F03	24.0122-0179.1	422179
MB587660	03.0137-0188.2	650188	MB950922	24.0118-0120.1	418120	40206-58A00	24.0118-0107.1	418107
MB587661	03.0137-0188.2	650188	MN102611	13.0460-5958.2	605958	40206-58A01	24.0118-0107.1	418107
MB597721	13.0460-5940.2	605940	MN102634	03.0137-0452.2	650452	40206-60Y01	24.0118-0107.1	418107
MB618192	03.0137-0289.2	650289	MN116706	24.0122-0175.1	422175	40206-61A01	24.0112-0123.1	412123
MB618193	03.0137-0289.2	650289	MN116923	13.0460-5958.2	605958	40206-61A11	24.0112-0123.1	412123
MB618194	03.0137-0289.2	650289	MR128153	24.0124-0136.1	424136	40206-71E01	24.0122-0146.1	422146
MB618344	24.0124-0144.1	424144	MR129103	13.0460-5958.2	605958	40206-71E02	24.0122-0146.1	422146
MB618716	24.0124-0140.1	424140	MR129104	13.0460-5958.2	605958	40206-71E05	24.0122-0146.1	422146
MB618734	24.0118-0112.1	418112	MR129648	24.0124-0140.1	424140	40206-71E06	24.0122-0146.1	422146
MB618735	24.0118-0112.1	418112	MR129649	24.0124-0140.1	424140	40206-88E01	24.0122-0174.1	422174
MB618737	24.0113-0183.1	413183	MR205377	13.0460-5826.2	605826	40206-88E04	24.0122-0174.1	422174
MB618799	24.0124-0142.1	424142	MR205584	24.0124-0136.1	424136	40206-88E05	24.0122-0174.1	422174
MB618981	24.3219-1752.3	020505	MR205585	24.0124-0136.1	424136	40206-90J01	24.0120-0152.1	420152
MB668083	24.0110-0240.1	410240	MR249357	24.0110-0266.1	410266	40206-93J00	24.0122-0146.1	422146
MB668108	24.0124-0142.1	424142	MR249964	24.3431-1701.5	240437	40206-93J01	24.0122-0146.1	422146
MB668336	03.0137-0288.2	650288	MR249965	24.3431-1702.5	240438	40206-C7000	24.0120-0119.1	420119
MB668337	03.0137-0288.2	650288	MR370775	24.3431-1701.5	240437	40206-C7001	24.0120-0119.1	420119
MB668338	03.0137-0288.2	650288	MR370776	24.3431-1702.5	240438	40206-G9500	24.0120-0119.1	420119
MB668745	03.0137-0255.2	650255	MR389541	13.0460-5952.2	605952	40206-Y9503	24.0122-0167.1	422167
MB668746	03.0137-0255.2	650255	MR389546	13.0460-5958.2	605958	41001-60Y00	24.3481-1726.5	240188
MB668747	03.0137-0255.2	650255	MR389548	13.0460-5958.2	605958	41001-60Y01	24.3481-1726.5	240188
MB699172	24.3541-1815.5	240383	MR389549	13.0460-5958.2	605958	41001-60Y02	24.3481-1726.5	240188
MB699173	24.3541-1816.5	240384	MR389569	13.0460-5826.2	605826	41060-01A25	13.0460-5963.2	605963
MB699174	13.0460-5952.2	605952	MR389578	13.0460-5980.2	605980	41060-01A85	13.0460-5963.2	605963
MB699266	13.0460-5952.2	605952	MR389599	13.0460-0235.2	610235	41060-04B25	13.0460-5962.2	605962
MB699280	24.0113-0186.1	413186	MR449769	24.0118-0120.1	418120	41060-04B90	13.0460-5962.2	605962
MB699281	24.0113-0186.1	413186	MR569597	13.0460-5958.2	605958	41060-04C85	13.0460-5937.2	605937
MB699282	24.0118-0120.1	418120	MZ690007	13.0460-5958.2	605958	41060-05B25	13.0460-5962.2	605962
MB699283	24.0118-0120.1	418120	MZ690010	13.0460-5980.2	605980	41060-05B26	13.0460-5962.2	605962
MB699291	24.0220-3017.1	480108	MZ690343	13.0460-5826.2	605826	41060-05B90	13.0460-5962.2	605962
MB699334	03.0137-0289.2	650289	X3511002	13.0460-5952.2	605952	41060-08N90	13.0460-5957.2	605957
MB699335	03.0137-0289.2	650289	X3511003	13.0460-5958.2	605958	41060-08N91	13.0460-5957.2	605957
MB699336	03.0137-0289.2	650289	X3516001	13.0460-5980.2	605980	41060-08N92	13.0460-5957.2	605957
MB699464	13.0460-5953.2	605953	X3516003	13.0460-5826.2	605826	41060-09W25	13.0460-5937.2	605937
MB699465	13.0460-0233.2	610233				41060-09W26	13.0460-5937.2	605937
MB699473	13.0460-5953.2	605953	NISSAN			41060-09W27	13.0460-5937.2	605937
MB699474	13.0460-5953.2	605953	30770-62Y01	24.3728-1703.2	591703	41060-09W92	13.0460-5937.2	605937
MB699761	24.0124-0147.1	424147	30770-62Y10	24.3728-1703.2	591703	41060-09W93	13.0460-5937.2	605937
MB857336	13.0460-5980.2	605980	30770-94J11	24.3728-1706.2	591706	41060-0H090	13.0460-5937.2	605937
MB857762	24.0110-0266.1	410266	36402-50J10	24.3727-1701.2	581701	41060-0H890	13.0460-5937.2	605937
MB857763	24.0110-0266.1	410266	36402-70J00	24.3727-1701.2	581701	41060-11P25	13.0460-5937.2	605937
MB857978	24.0110-0240.1	410240	36530-51Y10	24.3727-1701.2	581701	41060-11P26	13.0460-5937.2	605937
MB858375	13.0460-5952.2	605952	36530-71J10	24.3727-1711.2	581711	41060-11P29	13.0460-5937.2	605937
MB858380	13.0460-5980.2	605980	36530-71J10	24.3727-1708.2	581708	41060-11P85	13.0460-5937.2	605937
MB858398	13.0460-0235.2	610235	36531-71J10	24.3727-1709.2	581709	41060-11P86	13.0460-5937.2	605937



Vergleichsliste

Cross reference list - Tabella di conversione codici



Liste des correspondances - Lista referencias

NISSAN			NISSAN			NISSAN		
41060-11P91	13.0460-5937.2	605937	41060-V6793	13.0460-5937.2	605937	44080-58Y25	13.0460-0295.2	610295
41060-11P92	13.0460-5937.2	605937	41060-V6794	13.0460-5937.2	605937	44081-9C025	03.0137-9169.2	669169
41060-11P93	13.0460-5937.2	605937	41060-V7085	13.0460-5957.2	605957	44081-9C026	03.0137-9169.2	669169
41060-11P94	13.0460-5937.2	605937	41060-V7091	13.0460-5957.2	605957	44090-00QAD	03.0137-9228.2	669228
41060-13A25	13.0460-5963.2	605963	41060-VJ490	13.0460-5957.2	605957	44090-9C025	03.0137-9169.2	669169
41060-13A90	13.0460-5963.2	605963	41080-37J25	13.0460-0448.2	610448	44090-V0200	03.0137-9273.2	669273
41060-13E85	13.0460-5937.2	605937	41080-54C26	13.0460-0294.2	610294	44091-70J20	03.0137-9181.2	669181
41060-13E90	13.0460-5937.2	605937	41080-60Y25	13.0460-0336.2	610336	44091-70J25	03.0137-9181.2	669181
41060-13V90	13.0460-5937.2	605937	41080-C7126	13.0460-0448.2	610448	44100-04B00	24.3215-1107.3	020352
41060-13V91	13.0460-5937.2	605937	41083-01B02	13.0460-0319.2	610319	44100-04B02	24.3215-1107.3	020352
41060-16C90	13.0460-5937.2	605937	41083-01B03	13.0460-0319.2	610319	44100-04B04	24.3215-1107.3	020352
41060-19V85	13.0460-5937.2	605937	41083-01B13	13.0460-0319.2	610319	44100-0F000	24.3223-1709.3	020444
41060-2F025	13.0460-5950.2	605950	41083-09W20	13.0460-0322.2	610322	44100-0F001	24.3222-1717.3	020443
41060-2S790	13.0460-5957.2	605957	41083-41L10	13.0460-0322.2	610322	44100-0X800	24.3222-1124.3	020344
41060-2X825	13.0460-5959.2	605959	41083-Y9525	13.0460-0322.2	610322	44100-0X810	24.3220-1121.3	020343
41060-31E85	13.0460-5937.2	605937	41083-Y9526	13.0460-0322.2	610322	44100-17C10	24.3220-1703.3	020391
41060-31E87	13.0460-5937.2	605937	41139-9F500	11.8171-0008.1	990049	44100-17C11	24.3220-1703.3	020391
41060-31E88	13.0460-5937.2	605937	41139-9F525	11.0101-5407.2	260011	44100-17C12	24.3220-1703.3	020391
41060-31E90	13.0460-5937.2	605937	41142-9F525	11.0101-5407.2	260011	44100-50C10	24.3215-1107.3	020352
41060-31E91	13.0460-5937.2	605937	43202-09E00	24.0222-8025.2	480109	44100-50C11	24.3215-1107.3	020352
41060-31E92	13.0460-5937.2	605937	43203-09E00	24.0222-8025.2	480109	44100-50C12	24.3215-1107.3	020352
41060-31E93	13.0460-5937.2	605937	43204-01B00	24.0218-0021.1	480067	44100-50C13	24.3215-1107.3	020352
41060-32E90	13.0460-5937.2	605937	43204-01B01	24.0218-0021.1	480067	44100-7F000	24.3223-1709.3	020444
41060-32E92	13.0460-5937.2	605937	43206-0F001	24.0225-4014.1	480155	44100-U9200	24.3220-1703.3	020391
41060-32E94	13.0460-5937.2	605937	43206-21B10	24.0218-0022.1	480076	44101-70J20	24.3220-1625.3	020377
41060-32R94	13.0460-5933.2	605933	43206-50Y10	24.0218-0025.1	480082	46010-0F002	24.2123-1726.3	010557
41060-37G93	13.0460-5937.2	605937	43206-58Y00	24.0107-0108.1	407108	46201-00QAF	24.5111-0386.3	330503
41060-3S590	13.0460-5957.2	605957	43206-58Y01	24.0107-0108.1	407108	46242-00QAA	24.5111-0386.3	330503
41060-41B91	13.0460-5962.2	605962	43206-70A10	24.0222-8021.1	480092	D1060-11P26	13.0460-5937.2	605937
41060-44F92	13.0460-5933.2	605933	43206-88E03	24.0110-0244.1	410244	D1060-11P28	13.0460-5937.2	605937
41060-48R91	13.0460-5933.2	605933	43206-99J00	24.0110-0215.1	410215	D1060-11P29	13.0460-5937.2	605937
41060-4M525	13.0460-5950.2	605950	43206-99J01	24.0110-0215.1	410215	D1060-11P85	13.0460-5937.2	605937
41060-4M526	13.0460-5950.2	605950	44001-70J00	24.3344-1702.5	240088	D1060-11P86	13.0460-5937.2	605937
41060-50Y94	13.0460-5941.2	605941	44011-70J00	24.3344-1701.5	240087	D1060-11P87	13.0460-5937.2	605937
41060-56L25	13.0460-5937.2	605937	44060-05N25	03.0137-0310.2	650310	D1060-11P88	13.0460-5937.2	605937
41060-60S85	13.0460-5937.2	605937	44060-08G25	03.0137-0310.2	650310	D1060-11P90	13.0460-5937.2	605937
41060-60S87	13.0460-5937.2	605937	44060-0F026	03.0137-0376.2	650376	D1060-11P91	13.0460-5937.2	605937
41060-61A86	13.0460-5963.2	605963	44060-0F027	03.0137-0376.2	650376	D1060-11P92	13.0460-5937.2	605937
41060-62A90	13.0460-5963.2	605963	44060-0N690	13.0460-5983.2	605983	D1060-11P93	13.0460-5937.2	605937
41060-62A92	13.0460-5963.2	605963	44060-16C25	03.0137-0310.2	650310	D1060-2S790	13.0460-5957.2	605957
41060-62C90	13.0460-5941.2	605941	44060-16C26	03.0137-0310.2	650310	D1060-32E93	13.0460-5937.2	605937
41060-63C90	13.0460-5941.2	605941	44060-28N25	03.0137-0310.2	650310	D1060-32E94	13.0460-5937.2	605937
41060-63Y90	13.0460-5941.2	605941	44060-2S425	03.0137-0310.2	650310	D1060-37G94	13.0460-5937.2	605937
41060-67A90	13.0460-5963.2	605963	44060-3F025	13.0460-5986.2	605986	D1060-3C490	13.0460-5933.2	605933
41060-71J25	13.0460-5950.2	605950	44060-3F085	13.0460-5986.2	605986	D1060-79E92	13.0460-5933.2	605933
41060-71J26	13.0460-5950.2	605950	44060-47L25	03.0137-0210.2	650210	D1060-V6725	13.0460-5937.2	605937
41060-72J25	13.0460-5949.2	605949	44060-47L26	03.0137-0210.2	650210	D1060-V6790	13.0460-5937.2	605937
41060-80N90	13.0460-5933.2	605933	44060-48L25	03.0137-0210.2	650210	D1060-V6793	13.0460-5937.2	605937
41060-89A90	13.0460-5963.2	605963	44060-48L26	03.0137-0210.2	650210	D1060-V6794	13.0460-5937.2	605937
41060-89A91	13.0460-5963.2	605963	44060-50Y25	03.0137-0265.2	650265	D4060-5M490	13.0460-5983.2	605983
41060-9C125	13.0460-5959.2	605959	44060-54C91	13.0460-5983.2	605983			
41060-9C525	13.0460-5959.2	605959	44060-55L25	03.0137-0210.2	650210			
41060-9C526	13.0460-5959.2	605959	44060-56L25	03.0137-0210.2	650210			
41060-A1987	13.0460-5937.2	605937	44060-56L26	03.0137-0210.2	650210			
41060-BM425	13.0460-5950.2	605950	44060-56L27	03.0137-0210.2	650210			
41060-C8186	13.0460-5960.2	605960	44060-5M490	13.0460-5983.2	605983			
41060-D4690	13.0460-5937.2	605937	44060-60Y25	03.0137-0210.2	650210			
41060-G9800	13.0460-5960.2	605960	44060-63C90	13.0460-5983.2	605983			
41060-T7893	13.0460-5960.2	605960	44060-70J26	13.0460-5986.2	605986			
41060-V5025	13.0460-5937.2	605937	44060-70J28	03.0137-0276.2	650276			
41060-V5026	13.0460-5937.2	605937	44060-70N25	03.0137-0210.2	650210			
41060-V5090	13.0460-5937.2	605937	44060-73C91	13.0460-5983.2	605983			
41060-V5091	13.0460-5937.2	605937	44060-75C90	13.0460-5983.2	605983			
41060-V5093	13.0460-5937.2	605937	44060-78N91	13.0460-5983.2	605983			
41060-V5094	13.0460-5937.2	605937	44060-87N90	13.0460-5983.2	605983			
41060-V5785	13.0460-5937.2	605937	44060-9C025	03.0137-0269.2	650269			
41060-V5787	13.0460-5937.2	605937	44060-BM425	13.0460-5986.2	605986			
41060-V6786	13.0460-5937.2	605937	44060-BM426	13.0460-5986.2	605986			
41060-V6787	13.0460-5937.2	605937	44060-D5725	03.0137-0210.2	650210			
41060-V6790	13.0460-5937.2	605937	44080-4U025	13.0460-0295.2	610295			
41060-V6791	13.0460-5937.2	605937	44080-54C25	13.0460-0295.2	610295			
						NSU		
						40 51 01 529	03.3219-0203.3	020037
						56 56 00 900	13.0460-3010.2	603010
						56 56 00 904	13.0441-3801.2	250058
						56 56 02 902	13.0460-3010.2	603010
						67 53 00 511	03.3115-2651.3	010250
						67 56 00 509	03.3217-0401.3	020023
						67 57 00 518	03.3215-0221.3	020013
						9-8380-57-753	13.0460-3010.2	603010
						OPEL		
						12 38 342	24.8190-0703.2	620703
						12 38 343	24.8190-0702.2	620702
						12 38 348	24.8190-0705.2	620705
						12 38 349	24.8190-0704.2	620704
						12 38 353	24.8190-0701.2	620701
						12 38 369	24.8190-0703.2	620703
						12 38 403	24.8190-0706.2	620706

Vergleichsliste

Cross reference list - Tabella di conversione codici

Liste des correspondances - Lista referencias



OPEL		OPEL		OPEL				
12 38 404	24.8190-0708.2	620708	16 05 591	03.0137-0167.2	650167	16 05 910	03.0137-0267.2	650267
12 38 408	24.8190-0712.2	620712	16 05 592	03.0137-0165.2	650165	16 05 911	13.0460-7052.2	607052
12 38 409	24.8190-0709.2	620709	16 05 593	03.0137-0165.2	650165	16 05 916	13.0460-5942.2	605942
12 38 421	24.8190-0947.2	620947	16 05 594	03.0137-0167.2	650167	16 05 921	03.0137-0172.2	650172
12 38 783	24.8190-0716.2	620716	16 05 656	11.0101-4802.2	260007	16 05 923	11.0441-5704.2	250034
12 38 984	24.8190-0707.2	620707	16 05 657	11.0441-6003.2	250037	16 05 924	13.0460-4040.2	604040
16 05 003	13.0460-7080.2	607080	16 05 658	11.0101-5407.2	260011	16 05 931	13.0460-5942.2	605942
16 05 004	13.0460-2815.2	602815	16 05 668	13.0460-7048.2	607048	16 05 932	13.0460-2815.2	602815
16 05 005	13.0460-4040.2	604040	16 05 670	13.0460-7048.2	607048	16 05 938	03.0137-0172.2	650172
16 05 006	13.0460-4040.2	604040	16 05 671	13.0460-7048.2	607048	16 05 952	03.0137-0266.2	650266
16 05 007	13.0460-0347.2	610347	16 05 674	03.0137-0165.2	650165	16 05 953	03.0137-0267.2	650267
16 05 014	13.0441-5411.2	250114	16 05 686	03.0137-0172.2	650172	24404062	24.3727-0725.2	580725
16 05 026	13.0460-4040.2	604040	16 05 687	13.0460-4040.2	604040	24407363	24.3219-1111.3	020194
16 05 030	13.0441-4216.2	250093	16 05 689	03.0137-0166.2	650166	24407365	24.3217-1102.3	020168
16 05 031	13.0460-4040.2	604040	16 05 694	13.0441-3506.2	250052	2866166	24.3215-1101.3	020155
16 05 033	13.0460-2815.2	602815	16 05 696	13.0460-7048.2	607048	2894563	13.0441-5411.2	250114
16 05 044	11.0101-6004.2	260014	16 05 697	13.0460-7048.2	607048	3469270	13.0441-4825.2	250107
16 05 047	13.0460-4040.2	604040	16 05 699	13.0460-0127.2	610127	3476450	03.2120-1981.3	010105
16 05 056	03.0137-0267.2	650267	16 05 700	13.0460-0205.2	610205	3476971	03.2120-2381.3	010111
16 05 087	13.0460-7051.2	607051	16 05 703	13.0460-7048.2	607048	3476987	03.2120-2421.3	010112
16 05 141	13.0441-4825.2	250107	16 05 704	13.0460-7048.2	607048	3487272	24.0101-4801.2	990131
16 05 142	13.0441-4206.2	250087	16 05 710	13.0460-4035.2	604035	3487273	24.0101-4801.2	990131
16 05 144	13.0460-4035.2	604035	16 05 712	13.0460-4035.2	604035	3487287	13.0460-7048.2	607048
16 05 147	13.0460-3010.2	603010	16 05 713	13.0460-5030.2	605030	3487290	24.3481-0708.5	240024
16 05 148	13.0460-3010.2	603010	16 05 714	13.0460-5030.2	605030	3487291	24.3481-0707.5	240023
16 05 162	13.0441-4819.2	250104	16 05 715	13.0460-5030.2	605030	3487299	13.0460-7048.2	607048
16 05 183	13.0460-4035.2	604035	16 05 718	13.0460-4048.2	604048	3487331	24.3481-0705.5	240021
16 05 189	13.0460-6027.2	606027	16 05 722	13.0460-4048.2	604048	3487332	24.3481-0706.5	240022
16 05 192	13.0460-4035.2	604035	16 05 728	13.0460-4043.2	604043	3487380	24.3481-0705.5	240021
16 05 201	13.0460-4035.2	604035	16 05 739	03.0137-0108.2	650108	3487381	24.3481-0706.5	240022
16 05 204	13.0460-3010.2	603010	16 05 744	03.0137-0108.2	650108	3487991	24.3521-1701.5	240001
16 05 212	13.0460-4035.2	604035	16 05 746	13.0460-7052.2	607052	3487992	24.3521-1702.5	240002
16 05 216	13.0441-4825.2	250107	16 05 747	11.0101-5407.2	260011	3488811	03.2120-2381.3	010111
16 05 219	13.0460-4035.2	604035	16 05 748	11.0441-5202.2	250026	3488812	03.2120-2421.3	010112
16 05 291	13.0460-5030.2	605030	16 05 749	11.0441-5402.2	250028	3492361	24.2120-0913.3	010392
16 05 300	13.0460-5030.2	605030	16 05 764	03.0137-0172.2	650172	3492467	24.2120-0702.3	010361
16 05 305	03.0137-9014.2	669014	16 05 769	03.0137-0108.2	650108	3494033	13.0460-0127.2	610127
16 05 324	13.0460-3010.2	603010	16 05 772	03.0137-0108.2	650108	3494034	13.0460-0205.2	610205
16 05 327	13.0460-4035.2	604035	16 05 774	03.0137-0166.2	650166	4 18 117	24.0220-0012.1	480017
16 05 328	13.0460-4035.2	604035	16 05 781	03.0137-0165.2	650165	4 18 117	24.0220-0712.2	480208
16 05 382	03.0137-0108.2	650108	16 05 782	13.0460-2815.2	602815	44 00 323	03.0137-0330.2	650330
16 05 398	13.0460-5030.2	605030	16 05 783	13.0460-7048.2	607048	44 01 408	03.0137-0153.2	650153
16 05 431	13.0460-4048.2	604048	16 05 787	13.0460-7048.2	607048	44 02 883	24.3225-1601.3	020359
16 05 433	13.0460-4048.2	604048	16 05 788	13.0460-7048.2	607048	44 02 961	24.3223-1106.3	020317
16 05 448	13.0460-4035.2	604035	16 05 789	13.0460-7052.2	607052	44 03 271	13.0460-3969.2	603969
16 05 449	13.0460-4035.2	604035	16 05 791	13.0460-7048.2	607048	44 03 272	13.0460-3969.2	603969
16 05 454	13.0460-7052.2	607052	16 05 792	03.0137-0166.2	650166	44 03 283	24.0124-0103.1	424103
16 05 455	13.0460-7051.2	607051	16 05 795	13.0460-7048.2	607048	44 03 294	03.0137-0330.2	650330
16 05 463	13.0460-7048.2	607048	16 05 799	13.0460-4040.2	604040	44 09 164	24.5111-0386.3	330503
16 05 470	13.0460-4035.2	604035	16 05 803	13.0460-0205.2	610205	44 16 297	24.5111-0386.3	330503
16 05 477	03.0137-0143.2	650143	16 05 804	13.0460-0127.2	610127	44 67 098	13.0460-0217.2	610217
16 05 484	11.0441-4803.2	250018	16 05 808	13.0460-7052.2	607052	5 22 527	24.3727-0725.2	580725
16 05 485	13.0460-7048.2	607048	16 05 809	11.0441-4811.2	250024	5 22 545	24.3727-0711.2	580711
16 05 496	13.0460-7048.2	607048	16 05 810	13.0460-7051.2	607051	5 22 546	24.3727-0712.2	580712
16 05 504	13.0460-7048.2	607048	16 05 811	03.0137-0266.2	650266	5 22 548	24.3727-0721.2	580721
16 05 516	13.0460-4048.2	604048	16 05 812	03.0137-0267.2	650267	5 22 549	24.3727-0722.2	580722
16 05 533	13.0460-4048.2	604048	16 05 815	03.0101-0027.2	320022	5 22 559	24.3727-0720.2	580720
16 05 534	24.0101-4801.2	990131	16 05 817	03.0101-0025.2	320014	5 22 560	24.3727-0741.2	580741
16 05 535	24.0101-4801.2	990131	16 05 820	13.0460-7048.2	607048	5 22 561	24.3727-0732.2	580732
16 05 536	13.0460-7048.2	607048	16 05 824	13.0460-7051.2	607051	5 22 562	24.3727-0723.2	580723
16 05 544	13.0460-7048.2	607048	16 05 825	13.0460-5942.2	605942	5 22 568	24.3727-0730.2	580730
16 05 546	13.0460-7048.2	607048	16 05 855	13.0460-7080.2	607080	5 22 569	24.3727-0734.2	580734
16 05 556	13.0460-5030.2	605030	16 05 870	13.0460-7048.2	607048	5 22 570	24.3727-0727.2	580727
16 05 557	13.0460-5030.2	605030	16 05 877	13.0460-4043.2	604043	5 22 571	24.3727-0728.2	580728
16 05 562	13.0460-7048.2	607048	16 05 879	13.0460-4040.2	604040	5 22 572	24.3727-0729.2	580729
16 05 563	13.0460-7048.2	607048	16 05 881	13.0460-7051.2	607051	5 22 575	24.3727-0725.2	580725
16 05 568	03.0137-0143.2	650143	16 05 883	13.0460-4040.2	604040	5 22 578	24.3727-0725.2	580725
16 05 576	11.0101-4802.2	260007	16 05 887	03.0137-0167.2	650167	5 22 579	24.3727-0741.2	580741
16 05 582	13.0460-7048.2	607048	16 05 897	03.0137-0172.2	650172	5 22 580	24.3727-0732.2	580732
16 05 586	13.0460-7048.2	607048	16 05 905	11.0101-5407.2	260011	5 22 581	24.3727-0739.2	580739
16 05 590	03.0137-0166.2	650166	16 05 907	13.0460-7051.2	607051	5 22 585	24.3727-0736.2	580736



Vergleichsliste

Cross reference list - Tabella di conversione codici



Liste des correspondances - Lista referencias

OPEL		OPEL		OPEL				
5 22 587	24.3727-0728.2	580728	5 50 124	03.3222-6903.3	020084	5 62 359	24.5117-0195.3	330565
5 22 588	24.3727-0733.2	580733	5 50 125	03.3217-3503.3	020031	5 65 074	03.6565-0130.3	320098
5 22 589	24.3727-0739.2	580739	5 50 127	03.3219-6301.3	020056	5 65 081	03.0101-0014.2	320004
5 22 592	24.3727-0725.2	580725	5 50 128	24.3214-1101.3	020148	5 68 038	24.0223-0008.2	480038
5 22 593	24.3727-0737.2	580737	5 50 129	24.3217-1102.3	020168	5 68 039	24.0220-0001.2	480013
5 22 594	24.3727-0738.2	580738	5 50 130	24.3219-1111.3	020194	5 68 051	24.0223-0008.2	480038
5 22 595	24.3727-0736.2	580736	5 50 133	24.3219-1767.3	020552	5 68 053	24.0220-0011.2	480016
5 22 596	24.3727-0733.2	580733	5 50 134	24.3214-1102.3	020149	5 68 054	24.0220-0001.2	480013
5 22 597	24.3727-0734.2	580734	5 50 135	03.3217-3512.3	020032	5 68 056	24.0223-0008.2	480038
5 22 598	24.3727-0740.2	580740	5 50 140	03.3217-3512.3	020032	5 68 057	24.0220-0001.2	480013
5 22 599	24.3727-0739.2	580739	5 50 141	24.3219-1767.3	020552	5 68 058	24.0220-0011.2	480016
5 22 600	24.3727-0732.2	580732	5 50 142	24.3225-1702.3	020425	5 69 001	24.0124-0115.1	424115
5 22 601	24.3727-0734.2	580734	5 50 143	03.3217-3512.3	020032	5 69 001	24.0324-0115.1	524115
5 22 602	24.3727-0733.2	580733	5 50 144	24.3219-1767.3	020552	5 69 009	24.0122-0109.1	422109
5 22 620	24.3727-0733.2	580733	5 50 152	24.3225-1702.3	020425	5 69 013	24.0111-0116.1	411116
5 22 621	24.3727-0740.2	580740	5 50 153	24.3219-1715.3	020122	5 69 013	24.0113-0161.1	413161
5 22 640	24.3727-0732.2	580732	5 52 152	03.0137-0172.2	650172	5 69 013	24.0313-0161.1	513161
5 42 073	24.3481-0707.5	240023	5 58 017	03.2120-2597.3	010115	5 69 015	24.0113-0125.1	413125
5 42 074	24.3481-0708.5	240024	5 58 025	03.2123-6207.3	010185	5 69 016	24.0128-0104.1	428104
5 42 079	24.3481-0705.5	240021	5 58 043	03.2023-0642.3	010026	5 69 017	24.0110-0152.1	410152
5 42 080	24.3481-0706.5	240022	5 58 044	03.2022-0602.3	010006	5 69 020	24.0113-0161.1	413161
5 42 099	11.3541-8085.2	220287	5 58 045	03.2022-0702.3	010007	5 69 020	24.0313-0161.1	513161
5 42 099	24.3541-8085.5	240525	5 58 046	03.2022-1602.3	010011	5 69 022	24.0122-0126.1	422126
5 42 100	24.3541-8086.5	240526	5 58 050	03.2120-2597.3	010115	5 69 026	24.0113-0125.1	413125
5 42 101	24.3571-1705.5	240069	5 58 055	03.2122-8806.3	010157	5 69 027	24.0113-0126.1	413126
5 42 102	24.3571-1706.5	240070	5 58 056	03.2120-2598.3	010116	5 69 028	24.0110-0152.1	410152
5 42 215	24.3481-0705.5	240021	5 58 058	03.2122-0264.3	010129	5 69 029	24.0122-0109.1	422109
5 42 216	24.3481-0706.5	240022	5 58 062	03.2120-1981.3	010105	5 69 030	24.0113-0161.1	413161
5 42 225	24.3521-1701.5	240001	5 58 069	03.2123-6207.3	010185	5 69 030	24.0313-0161.1	513161
5 42 226	24.3521-1702.5	240002	5 58 070	03.2120-2381.3	010111	5 69 031	24.0120-0115.1	420115
5 42 229	13.2351-0013.2	210010	5 58 082	03.2022-1402.3	010010	5 69 031	24.0320-0115.1	520115
5 42 229	24.9235-0013.5	230001	5 58 089	03.2022-1602.3	010011	5 69 032	24.0122-0126.1	422126
5 42 230	13.2351-0014.2	210011	5 58 095	03.2023-0642.3	010026	5 69 036	24.0123-0100.1	423100
5 42 230	24.9235-0014.5	230002	5 58 099	03.2122-0282.3	010130	5 69 038	24.0124-0110.1	424110
5 42 231	24.3521-1701.5	240001	5 58 100	24.2120-0913.3	010392	5 69 039	24.0124-0111.1	424111
5 42 232	24.3521-1702.5	240002	5 58 102	24.2120-0702.3	010361	5 69 040	24.0113-0174.1	413174
5 42 241	11.9481-9871.2	220681	5 58 105	03.2123-1121.3	010176	5 69 041	24.0111-0116.1	411116
5 42 242	11.9481-9872.2	220682	5 58 128	03.2120-2598.3	010116	5 69 042	24.0124-0115.1	424115
5 42 243	11.9481-9871.2	220681	5 58 132	03.2123-4911.3	010182	5 69 042	24.0324-0115.1	524115
5 42 244	11.9481-9872.2	220682	5 58 137	03.2120-2421.3	010112	5 69 044	24.0128-0104.1	428104
5 42 245	24.3481-1733.5	240213	5 58 147	03.2122-8806.3	010157	5 69 046	24.0120-0140.1	420140
5 42 246	24.3481-1734.5	240214	5 58 179	03.2122-8806.3	010157	5 69 047	24.0124-0133.1	424133
5 42 250	24.3521-1702.5	240002	5 58 182	03.2120-2598.3	010116	5 69 054	24.0120-0115.1	420115
5 42 251	24.3521-1701.5	240001	5 58 184	03.2120-2381.3	010111	5 69 054	24.0320-0115.1	520115
5 42 450	24.3571-1705.5	240069	5 58 185	03.2120-2421.3	010112	5 69 055	24.0120-0140.1	420140
5 42 451	24.3571-1706.5	240070	5 58 187	03.2120-2598.3	010116	5 69 086	24.0122-0145.1	422145
5 42 529	11.8116-0097.1	390590	5 58 191	03.2120-0538.3	010077	5 69 101	24.0110-0191.1	410191
5 42 530	11.8116-0129.1	390591	5 58 192	03.2123-4911.3	010182	5 69 102	24.0110-0205.1	410205
5 42 880	11.8171-0008.1	990049	5 58 250	03.3318-0800.2	390112	5 69 105	24.0110-0249.1	410249
5 42 881	11.8171-0008.1	990049	5 58 325	03.3318-0800.2	390112	5 69 204	24.0110-0144.1	410144
5 45 205	24.7718-7301.2	990024	5 59 031	03.3508-8302.3	310046	5 69 206	24.0110-0204.1	410204
5 50 006	24.3219-1111.3	020194	5 59 037	03.3508-7504.3	310045	5 69 207	24.0110-0253.1	410253
5 50 009	24.3217-1102.3	020168	5 59 045	03.3508-8302.3	310046	5 69 801	24.0122-0156.1	422156
5 50 012	24.3215-1101.3	020155	5 59 055	03.3304-0700.1	390082	6 69 071	24.3728-0706.2	590706
5 50 036	24.3223-1103.3	020290	5 59 060	03.3304-1400.1	390088	6 69 088	24.3728-0708.2	590708
5 50 037	24.3223-1104.3	020291	5 59 522	03.3510-0059.1	390270	6 69 096	24.3728-0706.2	590706
5 50 040	03.3215-1701.3	020015	5 62 094	24.5233-0200.3	330425	6 69 124	24.3728-0708.2	590708
5 50 056	03.3215-1701.3	020015	5 62 229	83.6123-0381.3	330262	6 69 130	24.3728-0709.2	590709
5 50 057	03.3217-3503.3	020031	5 62 306	83.6267-0330.3	330333	6 69 132	24.3728-0710.2	590710
5 50 058	03.3222-6903.3	020084	5 62 314	83.6267-0285.3	330332	6 69 136	24.3728-0708.2	590708
5 50 061	24.3223-1103.3	020290	5 62 321	83.6267-0195.3	330737	6 69 142	24.3728-0711.2	590711
5 50 062	24.3223-1104.3	020291	5 62 325	83.6288-0314.3	330338	6 69 149	24.3728-0714.2	590714
5 50 066	03.3219-4202.3	020050	5 62 331	83.6267-0195.3	330737	6 69 155	24.3728-0717.2	590717
5 50 113	24.3214-1101.3	020148	5 62 336	83.6294-0315.3	330738	6 69 157	24.3728-0710.2	590710
5 50 114	24.3217-1102.3	020168	5 62 343	24.5232-0283.3	331323	6 69 159	24.3728-0719.2	590719
5 50 118	03.3219-6301.3	020056	5 62 344	24.5299-0309.3	331315	6 69 161	24.3728-0712.2	590712
5 50 119	24.3214-1101.3	020148	5 62 345	24.5298-0322.3	331314	6 69 165	24.3728-0717.2	590717
5 50 120	24.3217-1102.3	020168	5 62 346	24.5233-0200.3	330425	6 69 166	24.3728-0715.2	590715
5 50 121	03.3222-6903.3	020084	5 62 350	24.5298-0322.3	331314	6 69 168	24.3728-0717.2	590717
5 50 122	03.3219-4202.3	020050	5 62 352	24.5117-0195.3	330565	6 69 170	24.3728-0712.2	590712
5 50 123	03.3219-4202.3	020050	5 62 358	24.5298-0322.3	331314	6 79 305	24.2419-0938.3	030064

Vergleichsliste

Cross reference list - Tabella di conversione codici

Liste des correspondances - Lista referencias



OPEL		OPEL		OPEL				
6 79 307	24.2520-0904.3	040037	90167334	13.0460-7048.2	607048	90297407	13.0460-4035.2	604035
6 79 316	24.2419-0938.3	030064	90167528	03.3219-4202.3	020050	90297409	13.0460-4035.2	604035
7 80 350	10.0515-0515.3	340024	90167529	03.3222-6903.3	020084	90297410	13.0460-5030.2	605030
7 80 351	10.0515-0515.3	340024	90167540	03.3222-6903.3	020084	90297411	13.0460-5030.2	605030
8967747	03.3215-1701.3	020015	90167545	03.3217-3503.3	020031	90297412	13.0460-5030.2	605030
8967749	03.3217-3503.3	020031	90167765	13.0460-7048.2	607048	90297415	13.0460-4048.2	604048
8967751	03.3219-4202.3	020050	90168040	24.3214-1101.3	020148	90297419	13.0460-4048.2	604048
8967752	03.3222-6903.3	020084	90168041	24.3217-1102.3	020168	90297473	03.0137-0108.2	650108
8967753	24.3223-1103.3	020290	90168396	24.3214-1101.3	020148	90297533	13.2351-0014.2	210011
8967754	24.3223-1104.3	020291	90168958	24.0220-0001.2	480013	90297533	24.9235-0014.5	230002
8982484	24.0111-0116.1	411116	90184270	24.3727-0720.2	580720	90297534	13.2351-0013.2	210010
90006691	03.2122-8806.3	010157	90184271	24.3727-0741.2	580741	90297534	24.9235-0013.5	230001
90006694	03.2120-2598.3	010116	90187499	03.0137-0166.2	650166	90297537	13.0460-4043.2	604043
90006865	03.2120-0538.3	010077	90187568	24.3217-1102.3	020168	90297553	03.2022-1402.3	010010
90006866	03.2123-4911.3	010182	90187656	03.0137-0167.2	650167	90297554	03.2022-1602.3	010011
90007217	03.3510-0059.1	390270	90187869	03.0137-0165.2	650165	90297557	03.2023-0642.3	010026
90007425	24.3219-1111.3	020194	90187870	03.0137-0165.2	650165	90297753	03.0137-0108.2	650108
90007526	24.0220-0012.1	480017	90188047	03.0137-0167.2	650167	90297765	24.3521-1701.5	240001
90007526	24.0220-0712.2	480208	90189396	24.3214-1101.3	020148	90297766	24.3521-1702.5	240002
90008001	24.0113-0125.1	413125	90189473	03.3219-6301.3	020056	90297767	11.0441-5202.2	250026
90008002	24.0113-0126.1	413126	90189474	03.3219-4202.3	020050	90297768	11.0101-5407.2	260011
90008003	24.0110-0152.1	410152	90189718	24.3727-0727.2	580727	90297770	13.0460-7052.2	607052
90008004	24.0122-0109.1	422109	90189719	24.3727-0734.2	580734	90297771	11.8171-0008.1	990049
90008005	24.0113-0161.1	413161	90193039	24.3727-0728.2	580728	90297772	11.8116-0097.1	390590
90008005	24.0313-0161.1	513161	90193357	24.3727-0732.2	580732	90297777	11.0441-5402.2	250028
90008006	24.0120-0115.1	420115	90193915	24.0220-0011.2	480016	90297927	24.3727-0739.2	580739
90008006	24.0320-0115.1	520115	90199759	83.6267-0195.3	330737	90297932	24.0110-0205.1	412025
90008007	24.0122-0126.1	422126	90209335	24.3728-0711.2	590711	90305792	24.8190-0706.2	620706
90008027	24.0113-0125.1	413125	90216275	83.6294-0315.3	330738	90305918	24.8190-0708.2	620708
90008029	24.0110-0152.1	410152	90217234	24.3727-0723.2	580723	90334416	24.3728-0712.2	590712
90008030	24.0122-0109.1	422109	90222437	24.3727-0725.2	580725	90334462	24.3727-0736.2	580736
90008031	24.0113-0161.1	413161	90223402	24.3728-0714.2	590714	90335198	24.3728-0717.2	590717
90008031	24.0313-0161.1	513161	90223404	24.3727-0729.2	580729	90335385	24.3728-0719.2	590719
90008032	24.0120-0115.1	420115	90235420	03.3217-3512.3	020032	90335547	24.3727-0725.2	580725
90008032	24.0320-0115.1	520115	90235422	24.3219-1767.3	020552	90335784	24.8190-0705.2	620705
90008033	24.0122-0126.1	422126	90235472	03.6565-0130.3	320098	90335785	24.8190-0704.2	620704
90009095	11.0101-4802.2	260007	90235567	24.5232-0283.3	331323	90335899	24.3727-0732.2	580732
90009164	11.8171-0008.1	990049	90235568	24.5298-0322.3	331314	90335900	24.3727-0741.2	580741
90009273	11.0441-6003.2	250037	90235729	24.3728-0710.2	590710	90335983	24.2520-0904.3	040037
90009274	11.0101-5407.2	260011	90235948	24.3727-0730.2	580730	90342177	24.8190-0703.2	620703
90009433	24.0123-0100.1	423100	90235999	24.5233-0200.3	330425	90343961	24.8190-0709.2	620709
90009592	03.3217-3512.3	020032	90236355	24.5299-0309.3	331315	90343962	24.8190-0712.2	620712
90009593	24.3214-1102.3	020149	90250704	24.8190-0703.2	620703	90344249	24.3728-0715.2	590715
90009594	24.3219-1767.3	020552	90250705	24.8190-0702.2	620702	90344548	24.2419-0938.3	030064
90010584	13.0460-7048.2	607048	90271037	03.2120-2597.3	010115	90345102	24.8190-0716.2	620716
90010585	13.0460-7048.2	607048	90271041	03.0101-0014.2	320004	90345229	24.3728-0712.2	590712
90017053	24.0113-0126.1	413126	90271133	24.0124-0110.1	424110	90345232	24.3728-0717.2	590717
90017982	13.0460-4048.2	604048	90271134	24.0124-0111.1	424111	90345528	24.3727-0728.2	580728
90018692	13.0460-5030.2	605030	90271135	24.0113-0174.1	413174	90348213	03.2122-0282.3	010130
90019946	03.0137-0108.2	650108	90271938	03.0137-0165.2	650165	90348319	24.0110-0144.1	410144
90063339	03.0137-0172.2	650172	90272326	24.0111-0116.1	411116	90349868	03.0137-0172.2	650172
90077721	24.0223-0008.2	480038	90272328	24.0110-0191.1	410191	90350122	03.0137-0108.2	650108
90077917	83.6267-0330.3	330333	90272646	03.2023-0642.3	010026	90350153	03.0137-0108.2	650108
90079377	83.6267-0285.3	330332	90272647	03.2022-0602.3	010006	90350169	03.0137-0166.2	650166
90086193	24.0110-0152.1	410152	90272648	03.2022-0702.3	010007	90369384	24.3571-1705.5	240069
90086194	24.0220-0011.2	480016	90272649	03.2022-1602.3	010011	90369385	24.3571-1706.5	240070
90094695	03.0137-0143.2	650143	90272779	03.2122-8806.3	010157	90369713	24.3727-0733.2	580733
90094816	11.0441-4803.2	250018	90273259	03.0137-0172.2	650172	90369714	24.3727-0739.2	580739
90095703	24.3217-1102.3	020168	90273260	13.0460-4040.2	604040	90372058	24.8190-0947.2	620947
90095704	24.3214-1101.3	020148	90273262	03.0137-0166.2	650166	90373178	24.2419-0938.3	030064
90114542	13.0460-4048.2	604048	90278217	24.3728-0717.2	590717	90373856	24.3727-0732.2	580732
90114623	13.0460-4048.2	604048	90295005	13.0441-3506.2	250052	90373926	24.3727-0737.2	580737
90114693	03.2123-6207.3	010185	90295087	24.0124-0115.1	424115	90373927	24.3727-0738.2	580738
90114901	13.0460-7048.2	607048	90295087	24.0324-0115.1	524115	90374075	03.3217-3512.3	020032
90121718	83.6267-0195.3	330737	90295416	03.2120-2597.3	010115	90374076	24.3219-1767.3	020552
90135264	24.0223-0008.2	480038	90295577	13.0460-7048.2	607048	90374106	24.5298-0322.3	331314
90142096	03.3219-6301.3	020056	90295578	13.0460-7048.2	607048	90374841	24.3727-0725.2	580725
90147349	83.6288-0314.3	330338	90296446	03.2120-2598.3	010116	90374902	24.3727-0736.2	580736
90166278	13.0460-7048.2	607048	90297357	13.0460-7048.2	607048	90375403	24.3727-0739.2	580739
90166533	03.0137-0143.2	650143	90297358	13.0460-7048.2	607048	90375404	24.3727-0740.2	580740
90166854	11.0101-4802.2	260007	90297376	03.2122-0264.3	010129	90375405	24.3727-0734.2	580734



Vergleichsliste

Cross reference list - Tabella di conversione codici

Liste des correspondances - Lista referencias



OPEL		OPEL		PEUGEOT				
90375406	24.3727-0733.2	580733	90511128	24.0120-0140.1	420140	4241 23	03.0137-0197.2	650197
90392559	24.0128-0104.1	428104	90511162	13.0460-7052.2	607052	4241 25	03.0137-0201.2	650201
90397655	03.0137-0165.2	650165	90511254	10.0515-0515.3	340024	4241 3Q	03.0520-1220.3	691220
90398116	13.0460-2815.2	602815	90512907	03.0137-0172.2	650172	4241 55	03.0137-0202.2	650202
90398235	13.0460-7048.2	607048	90538629	24.3727-0732.2	580732	4241 56	03.0137-0271.2	650271
90398758	13.0460-7048.2	607048	90540169	11.0441-5704.2	250034	4241 57	03.0137-0203.2	650203
90398759	13.0460-7048.2	607048	90540177	13.0460-4040.2	604040	4241 58	03.0137-0330.2	650330
90398760	13.0460-7052.2	607052	90541257	13.0460-5942.2	605942	4241 59	03.0137-0269.2	650269
90398800	13.0460-7048.2	607048	90541293	13.0460-2815.2	602815	4241 6L	03.0520-0619.3	690619
90399218	03.0137-0166.2	650166	90541931	03.0137-0172.2	650172	4241 6N	03.0520-1220.3	691220
90399437	13.0460-7048.2	607048	90542862	03.0137-0266.2	650266	4241 6R	03.0520-1619.3	691619
90399472	10.0515-0515.3	340024	90542863	03.0137-0267.2	650267	4241 6T	03.0520-0519.3	690519
90399495	13.0460-7052.2	607052	9108323	03.0137-0330.2	650330	4241 71	03.0137-0201.2	650201
90421528	13.0460-4040.2	604040	9109408	03.0137-0153.2	650153	4241 72	03.0137-0197.2	650197
90421602	13.0460-0127.2	610127	9110883	24.3225-1601.3	020359	4241 73	03.0137-0196.2	650196
90421603	13.0460-0205.2	610205	9110961	24.3223-1106.3	020317	4241 7F	03.0520-0419.3	690419
90421703	24.3727-0734.2	580734	9111271	13.0460-3969.2	603969	4241 7J	03.0520-4120.3	694120
90421704	24.3727-0733.2	580733	9111272	13.0460-3969.2	603969	4241 7N	03.0520-5420.3	695420
90421727	24.0120-0140.1	420140	9111283	24.0124-0103.1	424103	4241 7P	03.0520-0919.3	690919
90421729	11.9481-9871.2	220681	91149506	03.0137-0267.2	650267	4241 91	03.0137-0271.2	650271
90421730	11.9481-9872.2	220682	91158366	03.0137-0267.2	650267	4241 94	03.0137-0124.2	650124
90421731	11.0441-4811.2	250024	91166506	24.5111-0386.3	330503	4241 A4	03.0137-0285.2	650285
90421736	13.0460-7051.2	607051	9192123	13.0460-7080.2	607080	4241 E5	03.0137-0197.2	650197
90421738	11.8116-0129.1	390591	9192124	13.0460-2815.2	602815	4241 E6	03.0137-0201.2	650201
90421739	11.9481-9871.2	220681	9192125	13.0460-4040.2	604040	4241 E7	03.0137-0195.2	650195
90421740	11.9481-9872.2	220682	9192126	13.0460-4040.2	604040	4241 E8	03.0137-0196.2	650196
90421744	24.3481-1733.5	240213	9193476	13.0460-4040.2	604040	4241 H6	03.0137-0347.2	650347
90421745	24.3481-1734.5	240214	9195057	13.0441-4216.2	250093	4241 H8	03.0137-0330.2	650330
90421796	03.0137-0266.2	650266	9195058	13.0460-4040.2	604040	4241 H9	03.0137-0269.2	650269
90421797	03.0137-0267.2	650267	9195077	13.0460-2815.2	602815	4241 J9	03.0137-0196.2	650196
90421834	03.0101-0025.2	320014	9201292	11.0101-6004.2	260014	4241 L3	03.0137-0196.2	650196
90421842	03.0101-0027.2	320022	9201354	13.0460-4040.2	604040	4242 25	03.0520-0519.3	690519
90421872	24.0110-0204.1	410204	9293027	03.0137-9014.2	669014	4242 29	03.0520-1619.3	691619
90425239	24.5117-0195.3	330565	93176120	13.0460-7051.2	607051	4246 42	24.0113-0128.1	413128
90425247	03.0101-0025.2	320014	93182283	24.0128-0104.1	428104	4246 69	24.0114-0107.1	414107
90425491	24.8190-0707.2	620707	93182290	24.0113-0161.1	413161	4246 85	24.0113-0168.1	413168
90425708	03.0101-0027.2	320022	93182290	24.0313-0161.1	513161	4246 88	24.0110-0183.1	410183
90442385	13.0460-7048.2	607048	93853917	24.5111-0386.3	330503	4246 89	24.0110-0187.1	410187
90442513	24.0124-0133.1	424133	94172376	24.0122-0156.1	422156	4246 90	24.0120-0131.1	420131
90442651	24.0110-0253.1	410253	94230541	24.3225-1702.3	020425	4246 94	24.0120-0132.1	420132
90442995	13.0460-7051.2	607051	94483220	13.0460-5942.2	605942	4246 94	24.0320-0132.1	520132
90443261	24.3219-1767.3	020552	95511282	24.0122-0145.1	422145	4246 95	24.0116-0105.1	416105
90443861	03.2123-1121.3	010176	97114300	13.0460-5942.2	605942	4246 96	24.0113-0168.1	413168
90443867	11.3541-8085.2	220287	97127616	24.3225-1702.3	020425	4246 97	24.0120-0133.1	420133
90443867	24.3541-8085.5	240525				4246 97	24.0320-0133.1	520133
90443868	24.3541-8086.5	240526				4246 99	24.0108-0105.1	408105
90443873	13.0460-7080.2	607080				4246 A0	24.0116-0106.1	416106
90443902	13.0460-7048.2	607048				4246 A1	24.0110-0199.1	410199
90444681	03.0137-0167.2	650167	2086 11	24.2528-1601.3	040063	4246 A2	24.0110-0199.1	410199
90444700	24.3571-1705.5	240069	2086 13	24.2528-1601.3	040063	4246 A5	24.0110-0187.1	410187
90444701	24.3571-1706.5	240070	2095 15	24.2419-0929.3	030057	4246 A6	24.0120-0131.1	420131
90445758	24.5233-0200.3	330425	2095 16	24.2419-1503.3	030079	4246 A7	24.0120-0132.1	420132
90468319	24.5233-0200.3	330425	2095 17	24.2419-0929.3	030057	4246 A7	24.0320-0132.1	520132
90468320	24.5298-0322.3	331314	2095 18	24.2419-0929.3	030057	4246 A7	24.0110-0183.1	410183
90468320	24.5117-0195.3	330565	2150 55	24.3728-0515.2	590515	4246 A9	24.0120-0133.1	420133
90485136	13.0460-4043.2	604043	2150 71	24.3728-0803.2	590803	4246 B1	24.0120-0133.1	420133
90485138	13.0460-4040.2	604040	2150 79	24.3728-0818.2	590818	4246 B1	24.0320-0133.1	520133
90485140	13.0460-7051.2	607051	2150 81	24.3728-0817.2	590817	4246 B2	24.0113-0128.1	413128
90487042	24.3521-1701.5	240001	2150 93	24.3728-0807.2	590807	4246 B3	24.0113-0168.1	413168
90487043	24.3521-1702.5	240002	2150 96	24.3728-0806.2	590806	4246 B4	24.0116-0105.1	416105
90487271	13.0460-4040.2	604040	2150 98	24.3728-0806.2	590806	4246 B8	24.0114-0107.1	414107
90487402	24.0124-0115.1	424115	2150 A6	24.3728-0813.2	590813	4246 E7	24.0122-0141.1	422141
90487402	24.0324-0115.1	524115	2150 A8	24.3728-0810.2	590810	4246 E8	24.0122-0141.1	422141
90495223	24.3727-0733.2	580733	2150 C0	24.3728-0811.2	590811	4246 F4	24.0126-0100.1	426100
90495224	24.3727-0740.2	580740	2150 C9	24.3728-0819.2	590819	4246 F6	24.0126-0100.1	426100
90498300	24.3219-1715.3	020122	2150 E0	24.3728-0812.2	590812	4246 F8	24.0108-0107.1	408107
90509590	24.0110-0249.1	410249	2150 E7	24.3728-0814.2	590814	4246 G0	24.0108-0107.1	408107
90509606	03.0137-0172.2	650172	2150 G2	24.3728-0843.2	590843	4246 G1	24.0122-0142.1	422142
90510227	11.0101-5407.2	260011	2150 L8	24.3728-0315.2	590315	4246 G9	24.0110-0199.1	410199
90510331	13.0460-7051.2	607051	4238 07	03.0137-0124.2	650124	4246 H0	24.0108-0105.1	408105
90511111	24.0120-0115.1	420115	4241 17	03.0137-0139.2	650139	4246 H3	24.0116-0106.1	416106
90511111	24.0320-0115.1	520115	4241 21	03.0137-0196.2	650196	4246 N8	24.0126-0100.1	426100



Vergleichsliste

Cross reference list - Tabella di conversione codici



Liste des correspondances - Lista referencias

PEUGEOT		PEUGEOT		PEUGEOT				
4246 R3	24.0120-0133.1	420133	4252 86	13.0460-4066.2	604066	4402 83	24.3220-1612.3	020239
4246 R3	24.0320-0133.1	520133	4253 14	13.0460-3952.2	603952	4402 86	24.3220-1607.3	020234
4246 V3	24.0122-0142.1	422142	4253 87	13.0460-5958.2	605958	4402 87	24.3220-1608.3	020235
4246 W5	24.0120-0133.1	420133	4254 30	13.0460-5958.2	605958	4402 88	24.3220-1609.3	020236
4246 W5	24.0320-0133.1	520133	4254 82	13.0460-7088.2	607088	4402 89	24.3220-1610.3	020237
4247 22	24.0225-4002.1	480048	4254 93	13.0460-4066.2	604066	4402 90	24.3219-1603.3	020200
4247 24	24.0222-8017.1	480071	4308 30	03.0137-9032.2	669032	4402 91	24.3219-1604.3	020201
4247 25	24.0218-0014.1	480009	4308 34	03.0137-9055.2	669055	4402 92	24.3219-1112.3	020311
4247 30	24.0218-0015.1	480010	4308 38	03.0137-9228.2	669228	4402 93	24.3219-1609.3	020319
4247 31	24.0218-0014.1	480009	4308 40	03.0137-9079.2	669079	4402 94	24.3219-1610.3	020320
4247 32	24.0218-0016.1	480011	4308 45	03.0137-9027.2	669027	4402 97	24.3220-1617.3	020244
4247 32	24.0218-0716.2	480203	4308 50	03.0137-9169.2	669169	4402 98	24.3220-1618.3	020245
4247 33	24.0216-5001.1	480001	4308 52	03.0137-9086.2	669086	4402 A0	24.3220-1615.3	020242
4247 33	24.0216-5701.2	480212	4308 53	03.0137-9175.2	669175	4402 A1	24.3220-1616.3	020243
4247 34	24.0218-0017.1	480060	4308 55	03.0137-9220.2	669220	4402 A6	24.3220-1715.3	020412
4247 35	24.0218-0020.1	480074	4308 57	03.0137-9228.2	669228	4427 26	13.0460-0402.2	610402
4247 35	24.0218-0720.2	480205	4308 58	03.0137-9158.2	669158	4427 30	13.0460-0404.2	610404
4247 42	24.0216-5001.1	480001	4308 59	03.0137-9228.2	669228	4427 55	13.0460-0435.2	610435
4247 42	24.0216-5701.2	480212	4308 61	03.0137-9228.2	669228	4427 65	13.0460-0403.2	610403
4247 43	24.0216-5001.1	480001	4308 62	03.0137-9088.2	669088	4427 66	13.0460-0424.2	610424
4247 43	24.0216-5701.2	480212	4315 13	03.0137-9089.2	669089	4427 70	11.8116-0073.1	390498
4247 44	24.0218-0020.1	480074	4315 14	03.0137-9055.2	669055	4427 84	11.8116-0129.1	390591
4247 44	24.0218-0720.2	480205	4400 83	24.3481-1609.7	220197	4427 94	13.0460-0424.2	610424
4248 33	13.0460-2901.2	602901	4400 84	24.3481-1610.7	220198	4439 14	11.0101-5407.2	260011
4248 64	13.0460-3928.2	603928	4400 A5	24.3481-1707.5	240073	4439 33	11.8171-0008.1	990049
4249 75	24.0122-0147.1	422147	4400 A6	24.3481-1708.5	240074	4448 34	11.0441-5401.2	250027
4249 95	24.0110-0187.1	410187	4400 E4	11.3481-9833.2	220561	4448 70	11.0441-4501.2	250015
4249 96	24.0120-0132.1	420132	4400 E4	24.3481-9833.5	240479	4448 74	11.0441-4811.2	250024
4249 96	24.0320-0132.1	520132	4400 E5	11.3481-9834.2	220562	4448 76	11.0441-3602.2	250008
4249 F0	24.0120-0133.1	420133	4400 E5	24.3481-9834.5	240480	4575 08	24.7718-7301.2	990024
4249 F0	24.0320-0133.1	520133	4400 G7	11.3481-9833.2	220561	4601 65	24.2119-1503.3	010404
4249 L1	24.0116-0105.1	416105	4400 G7	24.3481-9833.5	240479	4601 71	03.2120-1122.3	010084
4250 35	13.0460-3911.2	603911	4400 G8	11.3481-9834.2	220562	4601 75	24.2117-1501.3	010398
4250 37	13.0460-2956.2	602956	4400 G8	24.3481-9834.5	240480	4601 76	24.2119-1704.3	010339
4250 39	13.0460-2956.2	602956	4400 J4	11.3481-9833.2	220561	4601 83	24.2122-0801.3	010373
4250 41	13.0460-2955.2	602955	4400 J4	24.3481-9833.5	240479	4601 84	03.2119-1281.3	010054
4250 43	13.0460-3911.2	603911	4400 J5	11.3481-9834.2	220562	4601 85	03.2120-2031.3	010106
4250 50	13.0460-3911.2	603911	4400 J5	24.3481-9834.5	240480	4601 87	03.2119-3389.3	010057
4250 51	13.0460-3911.2	603911	4400 T9	24.3431-1701.5	240437	4601 88	24.2122-0801.3	010373
4250 54	13.0460-2901.2	602901	4400 V0	24.3431-1702.5	240438	4601 89	03.2119-3389.3	010057
4250 55	13.0460-2971.2	602971	4401 24	24.2730-1101.3	020339	4601 92	03.2119-3389.3	010057
4250 56	13.0460-2937.2	602937	4401 63	24.3481-1615.5	240031	4601 94	24.2120-1701.3	010427
4250 58	13.0460-2902.2	602902	4401 64	24.3481-1616.5	240032	4601 97	03.2119-3389.3	010057
4250 67	13.0460-3928.2	603928	4401 70	24.3384-1605.5	240295	4601 98	24.2122-1704.3	010423
4250 69	13.0460-3911.2	603911	4401 71	24.3384-1606.5	240296	4601 A2	03.2119-3389.3	010057
4250 70	13.0460-2955.2	602955	4402 21	24.3219-1114.3	020323	4601 A3	03.2120-2031.3	010106
4250 71	13.0460-3954.2	603954	4402 30	24.3222-1102.3	020257	4601 H4	03.2120-2031.3	010106
4250 72	13.0460-3911.2	603911	4402 38	24.3225-0903.3	020327	4601 H8	03.2120-2031.3	010106
4250 76	13.0460-3911.2	603911	4402 43	24.3223-1105.3	020292	4745 63	24.3727-0802.2	580802
4250 82	13.0460-2956.2	602956	4402 47	24.3222-1106.3	020261	4745 64	24.3727-0801.2	580801
4250 87	13.0460-2971.2	602971	4402 48	24.3222-1107.3	020262	4745 65	24.3727-0806.2	580806
4250 88	13.0460-3911.2	603911	4402 50	24.3222-1102.3	020257	4745 66	24.3727-0805.2	580805
4250 90	13.0460-4042.2	604042	4402 51	24.3220-1105.3	020216	4745 67	24.3727-0810.2	580810
4250 91	13.0460-3943.2	603943	4402 52	24.3222-1708.3	020407	4745 68	24.3727-0811.2	580811
4250 92	13.0460-3943.2	603943	4402 53	24.3220-1105.3	020216	4745 71	24.3727-0831.2	580831
4250 95	13.0460-2971.2	602971	4402 57	24.3220-1619.3	020246	4745 73	24.3727-0804.2	580804
4250 97	13.0460-3911.2	603911	4402 59	24.3222-1615.3	020285	4745 74	24.3727-0803.2	580803
4251 02	13.0460-3952.2	603952	4402 62	24.3220-0905.3	020207	4745 75	24.3727-0809.2	580809
4251 04	13.0460-3954.2	603954	4402 63	24.3220-1115.3	020312	4745 76	24.3727-0808.2	580808
4251 05	13.0460-2902.2	602902	4402 65	24.3219-1605.3	020202	4745 89	24.3727-0807.2	580807
4251 06	13.0460-2901.2	602901	4402 66	24.3219-1606.3	020203	4745 H7	24.3727-0816.2	580816
4251 08	13.0460-2842.2	602842	4402 67	24.3220-1609.3	020236	4745 T4	24.3727-0816.2	580816
4251 20	13.0460-3943.2	603943	4402 68	24.3220-1610.3	020237	4806 15	24.5122-0460.3	330493
4251 34	13.0460-7088.2	607088	4402 70	24.3225-1101.3	020294	4806 21	24.5112-0381.3	330711
4251 41	13.0460-3962.2	603962	4402 73	24.3219-1601.3	020198	4806 24	24.5112-0362.3	330512
4251 42	13.0460-7088.2	607088	4402 74	24.3219-1602.3	020199	4806 29	24.5112-0325.3	330415
4251 48	13.0460-3954.2	603954	4402 75	24.3219-1118.3	020332	4806 31	24.5112-0405.3	330428
4251 64	13.0460-4066.2	604066	4402 79	24.3222-1709.3	020111	4806 32	24.5112-0230.3	330508
4251 65	13.0460-3962.2	603962	4402 80	24.3222-1710.3	020112	4806 35	24.5112-0435.3	330524
4251 67	13.0460-7088.2	607088	4402 81	24.3226-1101.3	020296	4806 36	24.5112-0436.3	330574
4252 56	13.0460-3954.2	603954	4402 82	24.3220-1611.3	020238	4806 37	24.5112-0327.3	330417

Vergleichsliste

Cross reference list - Tabella di conversione codici

Liste des correspondances - Lista referencias



PORSCHE 	RENAULT 	RENAULT 
944 612 211 01	24.8190-0905.2	620905
944 612 211 02	24.8190-0904.2	620904
944 612 212 01	24.8190-0913.2	620913
944 612 365 00	24.8190-0916.2	620916
944 612 365 01	24.8190-0916.2	620916
950 116 237 07	24.2523-0909.3	040050
950 116 237 10	24.2523-0909.3	040050
950 116 237 11	24.2523-0909.3	040050
950 116 237 12	24.2523-0909.3	040050
951 351 041 00	24.0128-0165.1	428165
951 351 041 01	24.0128-0167.1	428167
951 351 041 02	24.0128-0166.1	428167
951 352 041 01	24.0124-0116.1	424116
951 352 041 02	24.0124-0117.1	424117
951 355 011 01	03.2023-0542.3	010024
951 355 079 30	83.6251-0301.3	330556
951 355 079 31	83.6251-0301.3	330556
964 351 041 02	24.0128-0174.1	428174
964 352 949 01	13.0460-4070.2	604070
964 352 949 03	13.0460-4070.2	604070
964 352 969 03	13.0460-4070.2	604070
964 355 139 00	83.6220-0296.3	330324
964 612 211 00	24.8190-0917.2	620917
964 612 363 00	24.8190-0917.2	620917
964 612 363 01	24.8190-0917.2	620917
964 612 365 01	24.8190-0918.2	620918
993 351 949 00	13.0460-4056.2	604056
993 355 139 00	83.6220-0296.3	330324
993 612 368 00	24.8190-0926.2	620926
993 612 965 00	24.8190-0927.2	620927
993 612 965 01	24.8190-0927.2	620927
996 352 993 00	03.0137-3002.2	653002
996 352 993 01	03.0137-3002.2	653002
996 352 993 02	03.0137-3002.2	653002
PROTON		
MB618981	24.3219-1752.3	020505
MB699280	24.0113-0186.1	413186
MB699281	24.0113-0186.1	413186
MB699283	24.0118-0120.1	418120
MB858375	13.0460-5952.2	605952
MB895072	13.0460-5952.2	605952
MB928314	13.0460-5826.2	605826
MB928817	13.0460-5953.2	605953
RENAULT		
08 54 697 500	24.3223-1102.3	020289
08 54 697 600	24.3223-1101.3	020288
08 55 860 900	24.3120-1702.3	010467
08 70 313 300	24.3223-1102.3	020289
08 70 313 400	24.3223-1101.3	020288
08 70 313 500	24.3219-1101.3	020189
41 06 021 92R	13.0460-2834.2	602834
41 06 093 42R	13.0460-2834.2	602834
44 0A 088 07R	11.0101-5407.2	260011
50 00 388 496	24.5112-0315.3	330509
50 01 000 446	24.3225-1101.3	020294
60 01 006 990	24.3727-1017.2	581017
60 01 547 616	24.3481-1611.5	240029
60 01 547 617	24.3481-1612.5	240030
60 01 547 619	13.0460-2834.2	602834
60 01 547 684	24.0112-0116.1	412116
60 01 547 703	24.0220-3021.1	480127
60 01 547 816	24.5111-0300.3	330407
60 01 547 819	24.5111-0300.3	330407
60 01 547 820	24.5229-0285.3	330032
60 01 547 911	13.0460-2834.2	602834
60 01 548 126	24.0218-0032.1	480118
60 01 549 211	24.0112-0116.1	412116
60 01 551 097	24.5229-0285.3	330032
60 06 004 557	24.3728-1006.2	591006
60 25 000 718	24.3728-1010.2	591010
60 25 001 018	03.6583-0005.3	320099
60 25 002 627	24.3727-1031.2	581031
60 25 002 628	24.3727-1031.2	581031
60 25 002 833	24.3728-1010.2	591010
60 25 004 479	03.2120-2031.3	010106
60 25 071 042	13.0460-2834.2	602834
60 25 103 090	24.3728-1015.2	591015
60 25 103 091	24.3728-1015.2	591015
60 25 105 202	03.6750-2902.4	300037
60 25 105 918	24.3727-1024.2	581024
60 25 105 919	24.3727-1024.2	581024
60 25 170 170	13.0460-2810.2	602810
60 25 170 405	24.2123-1701.3	010424
60 25 170 586	13.0460-3961.2	603961
60 25 170 698	03.0137-0271.2	650271
60 25 170 727	24.3728-1015.2	591015
60 25 170 728	24.3728-1015.2	591015
60 25 170 860	13.0460-3961.2	603961
60 25 170 972	03.2122-0626.3	010539
60 25 171 255	24.3728-1015.2	591015
60 25 171 256	24.3728-1026.2	591026
60 25 171 456	13.0460-2810.2	602810
60 25 171 471	24.3727-1031.2	581031
60 25 171 473	24.3727-1024.2	581024
60 25 307 608	24.5111-0260.3	330408
60 25 308 186	13.0460-4957.2	604957
60 25 370 305	03.0137-0347.2	650347
77 00 308 909	24.5111-0300.3	330407
77 00 419 824	24.0218-0032.1	480118
77 00 419 824	24.0218-0732.2	480207
77 00 421 739	24.0222-8019.2	480087
77 00 428 821	24.0220-3021.1	480127
77 00 502 515	24.0110-0139.1	410139
77 00 543 284	24.3222-1125.3	020356
77 00 561 367	24.0124-0103.1	424103
77 00 571 639	24.3727-1036.2	581036
77 00 571 640	24.3727-1037.2	581037
77 00 588 892	24.2528-0908.3	040065
77 00 617 298	24.2120-1715.3	010469
77 00 617 708	03.2119-0781.3	010052
77 00 618 661	03.2119-0781.3	010052
77 00 618 662	24.2120-1503.3	010397
77 00 624 692	03.2119-0781.3	010052
77 00 659 282	24.7718-7301.2	990024
77 00 665 654	24.2120-1709.3	010276
77 00 666 325	03.2119-1281.3	010054
77 00 685 063	03.6512-0100.3	320077
77 00 692 363	24.0225-4019.1	480305
77 00 694 069	03.2119-1281.3	010054
77 00 701 834	03.2120-1142.3	010085
77 00 704 705	24.0112-0116.1	412116
77 00 710 511	24.0222-8015.1	480055
77 00 710 664	24.0122-0143.1	422143
77 00 715 081	24.0120-0126.1	420126
77 00 715 165	24.0112-0133.1	412133
77 00 715 166	24.0112-0134.1	412134
77 00 716 684	24.2123-1702.3	010431
77 00 716 947	24.0108-0104.1	408104
77 00 717 331	24.2123-1702.3	010431
77 00 723 303	03.2125-3801.3	010215
77 00 724 410	24.2117-1503.3	010400
77 00 724 411	03.2119-3389.3	010057
77 00 725 424	03.6583-0011.3	320102
77 00 726 005	03.2119-3389.3	010057
77 00 730 235	03.6583-0014.3	320104
77 00 732 756	24.2528-0908.3	040065
77 00 734 129	03.2120-2682.3	010118
77 00 737 184	24.2120-1709.3	010276
77 00 737 818	03.6583-0014.3	320104
77 00 754 287	24.0120-0148.1	420148
77 00 754 882	24.3727-1005.2	581005
77 00 756 572	24.0120-0125.1	420125
77 00 757 354	24.0218-0013.1	480008
77 00 758 901	24.0120-0135.1	420135
77 00 764 192	24.0111-0122.1	411122
77 00 764 193	24.0120-0134.1	420134
77 00 766 098	24.3727-1010.2	581010
77 00 767 602	24.0122-0143.1	422143
77 00 773 916	24.0711-1403.3	360100
77 00 778 708	24.0111-0150.1	411150
77 00 780 077	24.0108-0108.1	408108
77 00 780 078	24.0108-0108.1	408108
77 00 780 892	24.0121-0106.1	421106
77 00 781 393	24.3727-1012.2	581012
77 00 781 394	24.3727-1011.2	581011
77 00 781 858	24.3728-1003.2	591003
77 00 783 030	24.0218-0032.1	480118
77 00 783 030	24.0218-0732.2	480207
77 00 783 392	24.0218-0013.1	480008
77 00 787 470	24.3728-1005.2	591005
77 00 787 630	03.2120-2031.3	010106
77 00 787 634	03.2119-3389.3	010057
77 00 793 047	24.0121-0101.1	421101
77 00 793 558	03.2120-2031.3	010106
77 00 793 631	24.0112-0133.1	412133
77 00 797 003	24.3728-1003.2	591003
77 00 799 541	03.2125-3801.3	010215
77 00 801 101	24.0121-0101.1	421101
77 00 801 213	24.0121-0103.1	421103
77 00 803 913	24.3728-1003.2	591003
77 00 804 076	03.2122-9631.3	010160
77 00 804 356	24.5111-0241.3	330680
77 00 804 899	24.2120-1725.3	010579
77 00 804 900	03.2120-2031.3	010106
77 00 804 901	03.2119-3389.3	010057
77 00 811 013	24.3728-1005.2	591005
77 00 811 705	24.5111-0386.3	330503
77 00 813 549	24.0121-0106.1	421106
77 00 816 858	24.3727-1012.2	581012
77 00 817 136	24.3727-1011.2	581011
77 00 818 346	24.0220-3021.1	480127
77 00 824 736	24.5111-0241.3	330680
77 00 827 866	24.0220-3021.1	480127
77 00 829 553	24.0108-0108.1	408108
77 00 832 611	24.5111-0280.3	330389
77 00 834 725	24.3728-1005.2	591005
77 00 839 322	24.0220-3021.1	480127
77 00 842 116	24.6583-1710.3	320166
77 00 842 131	24.0121-0106.1	421106
77 00 845 510	24.5111-0396.3	330609
77 00 859 233	24.3728-1006.2	591006
77 01 001 628	24.3223-1102.3	020289
77 01 001 629	24.3223-1101.3	020288
77 01 002 948	24.3220-1101.3	020212
77 01 002 994	24.3223-1101.3	020288
77 01 002 995	24.3223-1102.3	020289
77 01 004 720	03.0137-9039.2	669039
77 01 007 119	24.3119-1702.3	010465
77 01 010 665	03.0137-9020.2	669020
77 01 012 340	03.0137-9028.2	669028
77 01 020 062	24.3222-1609.3	020279
77 01 024 247	24.3222-1108.3	020263
77 01 024 248	24.3222-1109.3	020264
77 01 024 260	24.3222-1103.3	020258
77 01 024 264	24.3222-1609.3	020279
77 01 024 265	24.3222-1106.3	020261
77 01 024 266	24.3222-1107.3	020262
77 01 025 933	24.3222-1118.3	020315
77 01 025 935	24.3223-1106.3	020317



Vergleichsliste

Cross reference list - Tabella di conversione codici



Liste des correspondances - Lista referencias

RENAULT		RENAULT		RENAULT				
77 01 026 418	24.3223-1101.3	020288	77 01 201 769	24.3481-1611.5	240029	77 01 203 069	13.0460-3933.2	603933
77 01 026 419	24.3223-1102.3	020289	77 01 201 770	24.3481-1612.5	240030	77 01 203 070	13.0460-2983.2	602983
77 01 027 198	24.3222-1710.3	020112	77 01 201 823	03.0137-9056.2	669056	77 01 203 072	03.0137-0036.2	650036
77 01 027 199	24.3222-1709.3	020111	77 01 201 836	13.0460-0411.2	610411	77 01 203 124	13.0460-4957.2	604957
77 01 030 155	24.3225-1601.3	020359	77 01 201 864	13.0460-3961.2	603961	77 01 203 129	13.0460-2834.2	602834
77 01 031 504	24.3222-1709.3	020111	77 01 201 965	24.3481-1615.5	240031	77 01 203 275	24.2122-1501.3	010403
77 01 031 505	24.3222-1710.3	020112	77 01 201 966	24.3481-1616.5	240032	77 01 203 276	24.2120-1709.3	010276
77 01 032 318	24.3222-1122.3	020335	77 01 201 987	13.0460-0411.2	610411	77 01 203 277	24.2123-1702.3	010431
77 01 032 319	24.3222-1123.3	020336	77 01 202 050	13.0460-2983.2	602983	77 01 203 282	13.0460-2834.2	602834
77 01 032 924	24.3220-1603.3	020230	77 01 202 057	13.0460-3911.2	603911	77 01 203 418	13.0460-0438.2	610438
77 01 032 925	24.3220-1604.3	020231	77 01 202 141	13.0460-0435.2	610435	77 01 203 443	03.0520-0522.3	690522
77 01 033 311	24.3222-1618.3	020325	77 01 202 148	13.0460-3961.2	603961	77 01 203 545	03.0137-0271.2	650271
77 01 033 312	24.3222-1617.3	020324	77 01 202 205	03.0137-0153.2	650153	77 01 203 546	03.0137-9027.2	669027
77 01 033 390	24.3220-1623.3	020353	77 01 202 206	24.3451-1501.5	240263	77 01 203 563	03.0137-0271.2	650271
77 01 033 391	24.3220-1624.3	020354	77 01 202 207	24.3451-1502.5	240264	77 01 203 633	13.0460-4957.2	604957
77 01 033 548	24.3220-1115.3	020312	77 01 202 210	13.0460-3954.2	603954	77 01 203 668	13.0460-3822.2	603822
77 01 033 599	24.3220-1714.3	020411	77 01 202 213	13.0460-3955.2	603955	77 01 203 716	03.0137-0151.2	650151
77 01 033 600	24.3220-1713.3	020410	77 01 202 227	13.0460-3955.2	603955	77 01 203 719	24.2123-1701.3	010424
77 01 033 706	24.3220-1618.3	020245	77 01 202 283	13.0460-3911.2	603911	77 01 203 726	13.0460-4957.2	604957
77 01 033 707	24.3220-1617.3	020244	77 01 202 284	13.0460-2834.2	602834	77 01 203 728	13.0460-0438.2	610438
77 01 034 172	24.3223-1106.3	020317	77 01 202 285	13.0460-2834.2	602834	77 01 203 730	13.0460-2983.2	602983
77 01 034 173	24.3222-1118.3	020315	77 01 202 288	03.0137-0201.2	650201	77 01 203 775	13.0460-2834.2	602834
77 01 035 310	24.3220-1624.3	020354	77 01 202 289	13.0460-2834.2	602834	77 01 203 795	13.0460-2834.2	602834
77 01 035 311	24.3220-1623.3	020353	77 01 202 308	13.0460-3954.2	603954	77 01 203 796	13.0460-2834.2	602834
77 01 035 405	24.3220-1615.3	020242	77 01 202 347	03.0137-9086.2	669086	77 01 203 797	13.0460-2834.2	602834
77 01 035 406	24.3220-1616.3	020243	77 01 202 380	03.0137-9027.2	669027	77 01 203 862	03.0420-1020.3	681020
77 01 035 464	24.3220-1713.3	020410	77 01 202 381	03.0137-0271.2	650271	77 01 203 913	13.0460-3969.2	603969
77 01 035 465	24.3220-1714.3	020411	77 01 202 384	03.0137-0271.2	650271	77 01 203 918	13.0460-3969.2	603969
77 01 035 467	24.3222-1617.3	020324	77 01 202 475	13.0460-3911.2	603911	77 01 203 919	13.0460-3822.2	603822
77 01 035 468	24.3222-1618.3	020325	77 01 202 481	13.0460-3933.2	603933	77 01 203 968	13.0460-2983.2	602983
77 01 035 471	24.3220-1617.3	020244	77 01 202 516	13.0460-2834.2	602834	77 01 203 980	03.0137-9158.2	669158
77 01 035 472	24.3220-1618.3	020245	77 01 202 517	13.0460-3955.2	603955	77 01 204 036	13.0460-3822.2	603822
77 01 035 473	24.3220-1623.3	020353	77 01 202 518	13.0460-3911.2	603911	77 01 204 066	13.0460-2834.2	602834
77 01 035 474	24.3220-1624.3	020354	77 01 202 542	03.0137-0209.2	650209	77 01 204 087	13.0460-3933.2	603933
77 01 035 475	24.3222-1709.3	020111	77 01 202 543	03.0137-0211.2	650211	77 01 204 216	03.0137-0201.2	650201
77 01 035 476	24.3222-1710.3	020112	77 01 202 550	03.0137-9125.2	669125	77 01 204 220	13.0460-2983.2	602983
77 01 035 477	24.3222-1615.3	020285	77 01 202 598	03.0137-0153.2	650153	77 01 204 236	03.0520-0922.3	690922
77 01 036 385	24.3220-1623.3	020353	77 01 202 662	13.0460-3954.2	603954	77 01 204 268	03.0137-0209.2	650209
77 01 036 386	24.3220-1624.3	020354	77 01 202 709	13.0460-3968.2	603968	77 01 204 281	24.0124-0103.1	424103
77 01 039 388	24.3220-1623.3	020353	77 01 202 710	13.0460-3955.2	603955	77 01 204 282	24.0112-0116.1	412116
77 01 039 389	24.3220-1624.3	020354	77 01 202 711	13.0460-3911.2	603911	77 01 204 283	24.0120-0126.1	420126
77 01 039 390	24.3222-1617.3	020324	77 01 202 712	13.0460-2834.2	602834	77 01 204 285	24.0108-0104.1	408104
77 01 039 391	24.3222-1618.3	020325	77 01 202 713	13.0460-3969.2	603969	77 01 204 286	24.0120-0125.1	420125
77 01 039 392	24.3220-1617.3	020244	77 01 202 785	13.0460-3933.2	603933	77 01 204 288	24.0111-0122.1	411122
77 01 039 393	24.3220-1618.3	020245	77 01 202 788	13.0460-3961.2	603961	77 01 204 289	24.0122-0143.1	422143
77 01 039 394	24.3220-1623.3	020353	77 01 202 815	13.0460-3933.2	603933	77 01 204 291	24.0111-0150.1	411150
77 01 039 395	24.3220-1624.3	020354	77 01 202 820	03.0137-0209.2	650209	77 01 204 293	24.0108-0108.1	408108
77 01 043 789	24.3220-1713.3	020410	77 01 202 847	13.0460-3911.2	603911	77 01 204 294	24.0108-0108.1	408108
77 01 043 790	24.3220-1714.3	020411	77 01 202 848	13.0460-2834.2	602834	77 01 204 298	24.0121-0101.1	421101
77 01 049 101	11.8171-0008.1	990049	77 01 202 890	13.0460-3928.2	603928	77 01 204 299	24.0121-0103.1	421103
77 01 049 280	11.8116-0301.1	390610	77 01 202 891	13.0460-3955.2	603955	77 01 204 304	24.0121-0106.1	421106
77 01 049 765	11.8116-0301.1	390610	77 01 202 892	13.0460-3911.2	603911	77 01 204 357	13.0460-2834.2	602834
77 01 200 355	13.0460-3928.2	603928	77 01 202 893	13.0460-2967.2	602967	77 01 204 358	13.0460-2834.2	602834
77 01 200 360	13.0460-3961.2	603961	77 01 202 894	13.0460-2834.2	602834	77 01 204 523	24.0108-0108.1	408108
77 01 201 159	13.0460-2967.2	602967	77 01 202 895	13.0460-2834.2	602834	77 01 204 530	13.0460-3911.2	603911
77 01 201 208	03.0137-0082.2	650082	77 01 202 896	13.0460-2983.2	602983	77 01 204 605	03.2120-2031.3	010106
77 01 201 209	03.0137-0082.2	650082	77 01 202 897	03.0137-0036.2	650036	77 01 204 608	03.2120-2031.3	010106
77 01 201 229	03.0137-0271.2	650271	77 01 202 898	03.0137-0201.2	650201	77 01 204 609	24.2120-1725.3	010579
77 01 201 321	13.0460-3961.2	603961	77 01 202 899	03.0137-0201.2	650201	77 01 204 626	13.0460-3954.2	603954
77 01 201 381	03.0137-0124.2	650124	77 01 202 900	03.0137-0153.2	650153	77 01 204 634	03.0137-0330.2	650330
77 01 201 399	03.0137-0271.2	650271	77 01 202 903	13.0460-3961.2	603961	77 01 204 635	03.0137-9216.2	669216
77 01 201 533	03.0137-9211.2	669211	77 01 202 919	03.0137-0211.2	650211	77 01 204 637	03.0137-0330.2	650330
77 01 201 534	13.0460-3968.2	603968	77 01 202 921	03.0137-0271.2	650271	77 01 204 638	03.0137-0036.2	650036
77 01 201 542	13.0460-3911.2	603911	77 01 202 922	03.0137-0124.2	650124	77 01 204 639	03.0137-0330.2	650330
77 01 201 551	03.0137-9032.2	669032	77 01 202 954	13.0460-3928.2	603928	77 01 204 664	13.0460-3954.2	603954
77 01 201 617	03.0137-0036.2	650036	77 01 202 967	03.0137-0203.2	650203	77 01 204 673	03.0520-0125.3	690125
77 01 201 618	03.0137-9013.2	669013	77 01 202 973	13.0460-2983.2	602983	77 01 204 708	13.0460-3911.2	603911
77 01 201 664	24.3541-1625.5	240045	77 01 202 985	24.3481-1505.5	240047	77 01 204 828	24.0121-0106.1	421106
77 01 201 665	24.3541-1626.5	240046	77 01 202 986	24.3481-1506.5	240048	77 01 204 831	24.5111-0405.3	330410
77 01 201 669	13.0460-2834.2	602834	77 01 202 987	24.0101-4803.2	260049	77 01 204 833	13.0460-2834.2	602834
77 01 201 687	03.0137-9055.2	669055	77 01 203 068	13.0460-3961.2	603961	77 01 204 840	03.0137-9125.2	669125

Vergleichsliste

Cross reference list - Tabella di conversione codici

Liste des correspondances - Lista referencias



RENAULT			RENAULT			RENAULT		
77 01 204 845	13.0460-3954.2	603954	77 01 349 780	03.0137-0209.2	650209	82 00 131 598	24.5111-0241.3	330680
77 01 204 885	03.0137-9220.2	669220	77 01 349 782	03.6583-0011.3	320102	82 00 171 690	24.0222-8019.2	480087
77 01 204 901	24.0108-0108.1	408108	77 01 349 871	03.2120-2031.3	010106	82 00 404 264	24.5111-0386.3	330503
77 01 204 903	13.0460-3911.2	603911	77 01 349 928	03.0137-0271.2	650271	85 46 97 700	24.3219-1101.3	020189
77 01 204 918	03.2120-2031.3	010106	77 01 349 969	13.0460-3911.2	603911	86 71 000 083	24.0112-0116.1	412116
77 01 204 954	24.0120-0135.1	420135	77 01 349 970	13.0460-2834.2	602834	86 71 000 085	24.0120-0125.1	420125
77 01 204 978	03.0137-0153.2	650153	77 01 349 973	13.0460-2834.2	602834	86 71 000 107	13.0460-2834.2	602834
77 01 205 014	13.0460-3968.2	603968	77 01 365 004	24.3119-1703.3	010466	86 71 005 952	13.0460-4957.2	604957
77 01 205 015	13.0460-4957.2	604957	77 01 365 033	24.3222-1101.3	020256	86 71 005 976	24.0121-0106.1	421106
77 01 205 053	03.0520-0622.3	690622	77 01 365 089	24.3222-1125.3	020356	86 71 016 173	13.0460-2834.2	602834
77 01 205 094	03.2119-3389.3	010057	77 01 365 142	24.3223-1102.3	020289	86 71 016 191	13.0460-4957.2	604957
77 01 205 096	03.0520-1020.3	691020	77 01 365 143	24.3223-1101.3	020288	86 71 016 841	24.5229-0285.3	330032
77 01 205 098	03.0520-1020.3	691020	77 01 365 265	24.3223-1101.3	020288	87 03 13 500	24.3219-1101.3	020189
77 01 205 099	03.0520-1022.3	691022	77 01 365 266	24.3223-1102.3	020289			
77 01 205 104	03.0520-3122.3	693122	77 01 365 340	24.3119-1702.3	010465			
77 01 205 105	03.0520-0522.3	690522	77 01 365 377	24.3222-1125.3	020356			
77 01 205 132	03.2125-3801.3	010215	77 01 365 379	24.3222-1101.3	020256	AEU1947	13.0460-6910.2	606910
77 01 205 308	03.0520-2422.3	692422	77 01 365 380	24.3223-1102.3	020289	DBP3169	24.0112-0102.1	412102
77 01 205 309	03.0520-1722.3	691722	77 01 365 381	24.3223-1101.3	020288	DBP7954	24.0117-0101.1	417101
77 01 205 311	03.0520-1122.3	691122	77 01 365 382	24.3219-1101.3	020189	EGP1254	24.0110-0212.1	410212
77 01 205 312	03.0520-1122.3	691122	77 01 365 383	24.3220-1101.3	020212	EJP1437	13.0460-5998.2	605998
77 01 205 315	03.0520-6320.3	696320	77 01 365 389	24.3223-1101.3	020288	EJP1489	24.3219-1710.3	020386
77 01 205 355	13.0460-2834.2	602834	77 01 365 390	24.3223-1102.3	020289	GBC154	24.3541-1814.5	240382
77 01 205 462	03.0520-6320.3	696320	77 01 365 465	24.3222-1709.3	020111	GBC156	24.3541-1813.5	240381
77 01 205 495	13.0460-0438.2	610438	77 01 365 466	24.3222-1710.3	020112	GBC158	24.3304-1701.5	240113
77 01 205 496	13.0460-0438.2	610438	77 01 365 519	24.3222-1118.3	020315	GBC161	24.3304-1702.5	240114
77 01 205 518	03.0137-9228.2	669228	77 01 365 777	24.3222-1125.3	020356	GBD90800	24.0121-0100.1	421100
77 01 205 653	24.0121-0106.1	421106	77 01 454 307	13.0460-3961.2	603961	GBD90802	24.0110-0255.1	410255
77 01 205 689	03.0137-0153.2	650153	77 01 454 308	13.0460-3961.2	603961	GBD90803	24.0117-0101.1	417101
77 01 205 756	03.0137-9088.2	669088	77 01 457 999	03.0137-0082.2	650082	GBD90806	24.0110-0239.1	410239
77 01 205 915	03.0137-0330.2	650330	77 01 458 153	03.0137-0271.2	650271	GBD90810	24.0112-0102.1	412102
77 01 205 917	03.0137-0036.2	650036	77 01 458 154	03.0137-0271.2	650271	GBD90814	24.0117-0101.1	417101
77 01 206 082	13.0460-2834.2	602834	77 01 466 540	24.0110-0139.1	410139	GBD90817	24.0110-0212.1	410212
77 01 206 339	24.0121-0106.1	421106	77 01 466 782	24.0120-0148.1	420148	GBD90818	24.0112-0102.1	412102
77 01 206 972	03.0137-9158.2	669158	77 01 467 306	24.0112-0134.1	412134	GBD90819	24.0113-0188.1	413188
77 01 207 066	13.0460-2834.2	602834	77 01 467 307	24.0112-0133.1	412133	GBD90822	24.0121-0100.1	421100
77 01 207 958	24.3481-1615.5	240031	77 01 467 954	24.0120-0135.1	420135	GBD90825	24.0117-0101.1	417101
77 01 207 959	24.3481-1616.5	240032	77 01 467 955	24.0120-0134.1	420134	GBD90827	24.0112-0102.1	412102
77 01 207 960	13.0460-2834.2	602834	77 01 499 274	24.3481-1611.5	240029	GBD90829	24.0113-0188.1	413188
77 01 208 171	24.3481-1611.5	240029	77 01 499 275	24.3481-1612.5	240030	GBD90830	24.0121-0107.1	421107
77 01 208 172	24.3481-1612.5	240030	77 04 001 812	24.3727-1004.2	581004	GBD90835	24.0110-0233.1	410233
77 01 208 265	13.0460-2834.2	602834	77 04 001 925	24.5115-0400.3	330413	GBD90836	24.0123-0103.1	423103
77 01 210 130	13.0460-2834.2	602834	77 04 001 932	24.5228-0350.3	330396	GBD90837	24.0123-0102.1	423102
77 01 210 142	13.0460-2834.2	602834	77 04 001 939	24.5112-0220.3	330613	GBD90840	24.0121-0105.1	421105
77 01 348 071	13.0460-3928.2	603928	77 04 001 947	24.5112-0385.3	330392	GBP90213	13.0460-6914.2	606914
77 01 348 206	03.2119-0781.3	010052	77 04 001 948	24.5112-0385.3	330392	GBP90293	13.0460-5999.2	605999
77 01 348 224	24.2120-1718.3	010491	77 04 001 950	24.5229-0240.3	330400	GBP90297	13.0460-6914.2	606914
77 01 348 286	24.3119-1703.3	010466	77 04 001 952	24.5111-0320.3	330487	GBP90300	13.0460-2800.2	602800
77 01 348 468	24.2120-1715.3	010469	77 04 001 953	24.5111-0320.3	330487	GBP90307	13.0460-6914.2	606914
77 01 348 483	24.3119-1702.3	010465	77 04 001 954	24.5111-0345.3	330406	GBP90313	13.0460-2803.2	602803
77 01 348 682	13.0460-3968.2	603968	77 04 001 955	24.5111-0386.3	330503	GBP90314	13.0460-2805.2	602805
77 01 348 684	13.0460-3928.2	603928	77 04 002 443	24.5111-0150.3	330497	GBP90315AF	13.0460-0142.2	610142
77 01 348 689	13.0460-3961.2	603961	77 04 002 447	24.5111-0386.3	330503	GBP90315AF	13.0460-2803.2	602803
77 01 348 726	24.2119-1703.3	010323	77 04 002 450	24.5111-0320.3	330487	GBP90316	13.0460-5998.2	605998
77 01 348 863	13.0460-3928.2	603928	77 04 003 549	24.5229-0240.3	330400	GBP90316AF	13.0460-5998.2	605998
77 01 349 049	13.0460-3928.2	603928	77 04 003 765	24.5229-0285.3	330032	GBP90330AF	13.0460-5955.2	605955
77 01 349 122	24.3222-1710.3	020112	77 04 003 846	24.5111-0405.3	330410	GBP90336AF	13.0460-2803.2	602803
77 01 349 123	24.3222-1709.3	020111	77 04 003 887	24.5111-0241.3	330680	GBP90340AF	13.0460-2803.2	602803
77 01 349 150	24.3222-1101.3	020256	77 04 003 905	24.5229-0285.3	330032	GBP90341AF	13.0460-3605.2	603605
77 01 349 254	03.2119-1281.3	010054	77 04 003 913	24.5111-0300.3	330407	GBP90341AF	13.0470-3605.2	LD3605
77 01 349 391	24.3223-1101.3	020288	77 04 003 949	24.5111-0241.3	330680	GBS90821	03.0137-0179.2	650179
77 01 349 392	24.3223-1102.3	020289	77 04 003 955	24.5111-0320.3	330487	GBS90834AF	03.0137-0080.2	650080
77 01 349 448	13.0460-3928.2	603928	77 04 003 958	24.5111-0260.3	330408	GBS90836AF	03.0137-0339.2	650339
77 01 349 537	24.2120-1503.3	010397	77 04 003 961	24.5229-0255.3	330581	GWC1102	24.3219-1401.3	020351
77 01 349 648	03.0137-0201.2	650201	77 11 130 008	13.0460-3911.2	603911	GWC1150	24.3219-1121.3	020363
77 01 349 649	03.0137-0203.2	650203	77 11 130 034	13.0460-3911.2	603911	GWC1151	24.3219-1122.3	020364
77 01 349 705	03.0137-0124.2	650124	77 11 130 036	13.0460-2834.2	602834	GWC126	24.2723-1402.3	020350
77 01 349 706	03.0137-0271.2	650271	77 11 130 038	24.0121-0106.1	421106	GWC127	24.2723-1401.3	020342
77 01 349 735	03.6583-0007.3	320101	77 11 130 071	13.0460-2834.2	602834	GWC1520	24.3219-1710.3	020386
77 01 349 751	13.0460-2834.2	602834	82 00 003 478	24.5111-0386.3	330503	GWC901523	24.3219-1710.3	020386
77 01 349 762	03.2119-3389.3	010057	82 00 020 558	24.5229-0285.3	330032	GWC901634	24.3219-1743.3	020485



Vergleichsliste

Cross reference list - Tabella di conversione codici

Liste des correspondances - Lista referencias



ROVER		SAAB		SEAT				
GWC901635	24.3219-1743.3	020485	7874548	13.0460-0431.2	610431	191 611 701 A	83.6225-0287.3	330735
SDB000990	24.0121-0105.1	421105	8904575	24.0111-0120.1	411120	191 612 151	03.6584-0015.3	320109
SDB100600	24.0121-0105.1	421105	8910309	13.0441-4819.2	250104	191 615 123	24.3481-1745.5	240277
SFP000390	13.0460-2803.2	602803	891031	13.0460-4035.2	604035	191 615 124	24.3481-1746.5	240278
SFP000410	13.0460-2803.2	602803	891048	13.0460-4035.2	604035	191 698 151 F	13.0460-7030.2	607030
SFP100220EVA	13.0460-5929.2	605929	8910481	13.0460-4035.2	604035	191 698 151 G	13.0460-7033.2	607033
SFP100260	13.0460-2803.2	602803	8931784	24.5310-0270.3	331369	191 698 151 H	13.0460-7032.2	607032
SFP100520	13.0460-3605.2	603605	8934036	24.0113-0141.1	413141	191 698 151 J	13.0460-7032.2	607032
SFP100520	13.0470-3605.2	LD3605	8937898	24.3727-1101.2	581101	191 698 151 K	13.0460-7032.2	607032
SFS100090	03.0137-0339.2	650339	8940819	24.5303-0275.3	331213	191 698 447	11.0101-4803.2	260008
SML000020	24.3219-1743.3	020485	8941981	24.0113-0117.1	413117	191 698 451 C	13.0460-2937.2	602937
SML000030	24.3219-1743.3	020485	8951543	24.0109-0130.1	409130	191 698 451 D	13.0460-2937.2	602937
SML100080	24.3219-1743.3	020485	8953291	83.6169-0505.3	330288	191 721 335 AB	24.3728-0121.2	590121
SML100090	24.3219-1743.3	020485	8955171	24.0123-0101.1	423101	191 927 807 A	24.0711-1313.3	360016
SXS100000	03.0137-9701.2	669701	8955312	03.3517-0101.2	390322	191 927 807 D	24.0721-1925.1	360039
			8955445	11.0101-5407.2	260011	1H0 501 615 A	24.0220-0018.1	480019
			8955486	11.8171-0008.1	990049	1H0 501 615 A	24.0220-0718.2	480209
			8961815	13.0460-2811.2	602811	1H0 609 525	03.0137-0268.2	650268
			8961831	11.3334-8002.2	220007	1H0 609 525 D	03.0137-0268.2	650268
32000298	24.0113-0117.1	413117	8961849	11.0441-3302.2	250004	1H0 609 526	03.0137-0268.2	650268
4001517	24.0711-1154.1	360009	8961856	13.0460-3306.2	603306	1H0 609 526 D	03.0137-0268.2	650268
4001525	24.0711-1155.1	360010	8963092	24.0712-1308.3	360032	1H0 609 527	03.0137-0268.2	650268
4001541	24.0711-1157.1	360012	8963613	24.0712-1307.3	360031	1H0 609 527 D	03.0137-0268.2	650268
4002143	24.0125-0125.1	425125	8965139	83.6155-0327.3	330287	1H0 609 528	03.0137-0268.2	650268
4002150	24.0123-0101.1	423101	8965550	24.0123-0101.1	423101	1H0 609 528 D	03.0137-0268.2	650268
4002341	83.6169-0505.3	330288	8965584	24.0712-1309.3	360033	1H0 611 053	24.3219-0909.3	020188
4004123	13.0460-2811.2	602811	8965857	24.0712-1310.3	360034	1H0 611 053 A	24.3215-0903.3	020154
4106720	83.6169-0505.3	330288	8965980	24.0125-0125.1	425125	1H0 611 701	24.5105-0442.3	331432
4107116	13.0460-2811.2	602811	8966962	24.0123-0101.1	423101	1H0 611 701 F	24.5105-0442.3	331432
4196317	13.0460-3306.2	603306	8967481	24.3727-1105.2	581105	1H0 611 775	83.7836-0135.3	330816
4198438	10.6123-0522.3	010633	8967499	24.3727-1107.2	581107	1H0 612 151 A	03.0101-0025.2	320014
4199438	10.6123-0522.3	010633	8967630	24.3727-1105.2	581105	1H0 612 151 C	03.6584-0113.3	320111
4241428	24.0124-0133.1	424133	8968018	13.0460-2811.2	602811	1H0 612 151 E	03.6584-0113.3	320111
4241444	24.5298-0322.3	331314	8968026	13.0460-3306.2	603306	1H0 615 301 A	24.0122-0100.1	422100
4241469	13.2351-0014.2	210011	8968968	11.0441-5702.2	250033	1H0 615 301 A	24.0322-0100.1	522100
4241469	24.9235-0014.5	230002	8968976	13.0460-5703.2	605703	1H0 615 423	24.3384-1707.5	240171
4241477	24.0110-0249.1	410249	8969107	11.0101-5407.2	260011	1H0 615 423 B	24.3384-1707.5	240171
4243218	13.2351-0013.2	210010	8969123	11.8116-0073.1	390498	1H0 615 423 DX	24.3384-1707.5	240171
4243218	24.9235-0013.5	230001	8969206	83.6155-0327.3	330287	1H0 615 424	24.3384-1708.5	240172
4426474	83.6169-0505.3	330288	8969651	11.8171-0008.1	990049	1H0 615 424 B	24.3384-1708.5	240172
4426490	83.6169-0505.3	330288	8970006	11.3334-8002.2	220007	1H0 615 424 DX	24.3384-1708.5	240172
4426508	83.6155-0327.3	330287	8970626	11.3334-8002.2	220007	1H0 698 151	13.0460-7032.2	607032
4467049	13.0460-7080.2	607080	8970709	24.0123-0101.1	423101	1H0 698 401	03.0101-0025.2	320014
4467064	11.0101-5407.2	260011	8970717	24.0109-0130.1	409130	1H0 698 451	13.0460-2984.2	602984
4467072	13.0460-4043.2	604043	8970741	24.3727-1107.2	581107	1H0 698 451 A	13.0460-2984.2	602984
4467080	13.0441-3506.2	250052	8970816	11.8116-0047.1	390494	1H0 698 451 B	13.0460-2937.2	602937
4482543	24.3541-8086.5	240526	8973034	83.6169-0505.3	330288	1H0 698 451 C	13.0460-2937.2	602937
4482550	11.3541-8085.2	220287	8993719	13.0460-2811.2	602811	1H0 698 451 D	13.0460-2984.2	602984
4482550	24.3541-8085.5	240525	8993768	13.0460-5703.2	605703	1H0 698 451 E	13.0460-2937.2	602937
4483285	24.5117-0195.3	330565	8993974	13.0460-2811.2	602811	1H0 698 451 F	13.0460-2937.2	602937
4483723	13.0460-7080.2	607080	8994840	13.0460-2811.2	602811	1H0 698 451 G	13.0460-2984.2	602984
4543419	03.0137-0172.2	650172	90297771	13.0441-3001.2	250041	1H0 698 451 H	13.0460-2937.2	602937
4543930	03.2123-1121.3	010176	90510227	11.8171-0008.1	990049	1H0 698 525	03.0137-0268.2	650268
4544326	03.0137-0172.2	650172	9101650	11.0101-5407.2	260011	1H0 698 525 V	03.0137-0268.2	650268
4565719	24.5233-0200.3	330425		83.6155-0160.3	330717	1H0 698 525 X	03.0137-0268.2	650268
4646899	13.0460-7080.2	607080				1H0 698 545	03.0137-9168.2	669168
4648457	13.0460-7080.2	607080				1H0 698 545 A	03.0137-9168.2	669168
4778262	11.0441-5704.2	250034				1H0 698 545 B	03.0137-9168.2	669168
4836441	03.0137-0172.2	650172	16500253	24.0111-0130.1	411130	1H0 927 807	24.0711-1361.3	360022
4836987	13.0460-4040.2	604040	171 611 701 L	24.5170-0315.3	331309	1H0 927 808	24.0711-1362.3	360023
4837241	13.0460-4040.2	604040	171 611 775	24.5201-0164.3	331414	1H1 611 019 A	03.2120-3943.3	010532
4838660	03.0137-0172.2	650172	171 698 447 A	11.0101-4801.2	260006	1H1 611 019 B	03.2122-1042.3	010137
4839700	13.0460-5703.2	605703	171 698 545	11.0441-4808.2	250022	1H1 611 019 C	03.2120-3943.3	010532
5055769	13.0460-5703.2	605703	191 501 615 A	03.0137-9008.2	669008	1H1 698 019 A	10.6123-0674.3	010639
5055967	13.0460-3306.2	603306	191 501 615 A	24.0220-0018.1	480019	1J0 611 053	24.3220-0909.3	020210
5057336	13.0460-4040.2	604040	191 501 615 A	24.0220-0718.2	480209	1J0 698 151 L	13.0460-7081.2	LD7081
5058110	13.0460-3605.2	603605	191 501 615 B	24.0218-0007.1	480003	1J0 698 151 L	13.0460-7081.2	LD7081
5058110	13.0470-3605.2	LD3605	191 501 615 B	24.0218-0707.2	480211	1J0 698 545	03.0137-9149.2	669149
5061759	11.8116-0143.1	390513	191 609 721 E	24.3727-0132.2	580132	1J0 927 803	24.0711-1361.3	360022
5061817	11.0441-3803.2	250010	191 609 721 F	24.3727-0133.2	580133	1J0 927 804	24.0711-1362.3	360023
5391917	11.0441-4002.2	250011	191 611 019	03.2120-2031.3	010106	1L0 609 721 A	24.3727-0133.2	580133
7873698	13.0460-0431.2	610431	191 611 701	24.5170-0315.3	331309			



Vergleichsliste

Cross reference list - Tabella di conversione codici



Liste des correspondances - Lista referencias

SEAT 	SEAT 	SEAT 
251 615 219	11.8171-0008.1	990049
321 615 301	24.0112-0106.1	412106
321 615 301	24.0312-0106.1	512106
321 615 301 C	24.0120-0123.1	420123
321 615 301 C	24.0320-0123.1	520123
321 615 301 D	24.0120-0128.1	420128
321 615 301 D	24.0320-0128.1	520128
321 698 545	03.0137-9041.2	669041
331 611 051 A	03.3217-2112.3	020027
331 698 051 A	03.3217-2112.3	020027
357 609 525 C	03.0137-0264.2	650264
357 609 526 C	03.0137-0264.2	650264
357 609 527	03.0137-0268.2	650268
357 609 527 E	03.0137-0264.2	650264
357 609 528	03.0137-0268.2	650268
357 609 528 E	03.0137-0264.2	650264
357 611 019	03.2120-3943.3	010532
357 611 019 B	03.2122-1042.3	010137
357 612 107	03.7750-4302.4	300076
357 612 107 A	03.7750-4302.4	300076
357 612 151	03.6584-0015.3	320109
357 615 123 A	24.3541-1609.5	240039
357 615 123 AX	24.3541-1609.5	240039
357 615 123 B	24.3541-1731.5	240061
357 615 123 BX	24.3541-1731.5	240061
357 615 124 A	24.3541-1610.5	240040
357 615 124 AX	24.3541-1610.5	240040
357 615 124 B	24.3541-1732.5	240062
357 615 124 BX	24.3541-1732.5	240062
357 615 301	24.0113-0178.1	413178
357 615 301	24.0313-0178.1	513178
357 615 601	24.0110-0111.1	410111
357 615 601	24.0110-0275.2	410275
357 615 601 B	24.0110-0203.1	410203
357 615 601 B	24.0110-0276.2	410276
357 698 151 A	13.0460-2957.2	602957
357 698 151 B	13.0460-2958.2	602958
357 698 525 CV	03.0137-0264.2	650264
357 698 525 CX	03.0137-0264.2	650264
357 698 525 V	03.0137-0268.2	650268
357 721 261 A	24.2523-0908.3	040049
3A0 611 053	24.3220-0909.3	020210
3A0 615 123	11.3541-8523.2	220115
3A0 615 123	24.3541-8523.5	240551
3A0 615 123 A	11.3541-8523.2	220115
3A0 615 123 A	24.3541-8523.5	240551
3A0 615 124	11.3541-8524.2	220116
3A0 615 124	24.3541-8524.5	240552
3A0 615 124 A	11.3541-8524.2	220116
3A0 615 124 A	24.3541-8524.5	240552
3A0 615 125	11.8170-0306.1	260102
3A0 615 125 A	11.8170-0306.1	260102
3A0 698 151	13.0460-7081.2	607081
3A0 698 151	13.0470-7081.2	LD7081
3A0 698 151 A	13.0460-7081.2	607081
3A0 698 151 A	13.0470-7081.2	LD7081
3A0 698 471	11.0441-5409.2	250031
3A1 698 019	03.2123-1424.3	010637
3A1 721 388	03.2419-1206.3	030074
3A2 698 019	03.2123-1484.3	010595
3B0 615 125	11.8170-0306.1	260102
4341534	13.0460-3936.2	603936
437 611 775	24.5170-0161.3	331308
443 611 190	03.3517-5100.1	390326
443 698 647	11.0101-5409.2	260035
4A0 615 125 A	11.8170-0306.1	260102
4A0 615 269	11.8116-0143.1	390513
4A0 615 301 C	24.0125-0105.1	425105
4A0 615 301 C	24.0325-0105.1	525105
4A0 615 301 D	24.0111-0130.1	411130
4A0 615 301 D	24.0111-0129.1	411129
4A0 615 301 E	24.0218-5001.1	480012
4A0 615 301 E	24.3727-2701.2	582701
4A0 615 601 A	24.3217-1115.3	020310
4A0 615 601 A	24.5112-0412.3	330569
4A0 615 601 A	24.3727-2705.2	582705
4A0 698 471	24.3219-0803.3	020183
4B0 615 125	03.0137-0015.2	650015
4D0 698 647	24.3219-0803.3	020183
6Q0 611 053 B	03.0137-0015.2	650015
6Q0 611 053 C	03.0137-0015.2	650015
6Q0 698 525 A	24.3727-0503.2	580503
6Q0 698 525 B	03.0137-0015.2	650015
6U0 501 615 A	24.0113-0182.1	413182
6U0 501 615 A	13.0460-2964.2	602964
6U0 501 615 B	03.0137-0268.2	650268
6U0 501 615 B	03.0137-0268.2	650268
6U0 611 053 A	24.0220-0018.1	480019
6U0 611 053 B	24.0220-0718.2	480209
6U0 611 701 A	24.3222-1712.3	020422
6U0 611 701 B	24.3219-1721.3	020422
6U0 612 151 A	24.5166-0325.3	331293
6U0 615 301	24.5166-0325.3	331293
6U0 698 151	03.6584-0107.3	320110
6U0 698 151 A	24.0113-0182.1	413182
	13.0460-2964.2	602964
	24.0113-0169.1	413169
	24.0113-0193.1	413193
	13.0460-2964.2	602964
	13.0460-2964.2	602964
	24.3219-1721.3	020422
	24.5228-0235.3	330395
	24.5228-0235.3	330395
	24.3222-1712.3	020424
	03.6584-0107.3	320110
	24.0220-0018.1	480019
	24.0220-0718.2	480209
	24.3219-0909.3	020188
	03.6584-0107.3	320110
	03.6584-0107.3	320110
	03.6584-0107.3	320110
	03.6584-0107.3	320110
	03.0137-9168.2	669168
	03.0137-9168.2	669168
	24.3220-0909.3	020210
	13.0460-7081.2	607081
	13.0470-7081.2	LD7081
	03.0137-9149.2	669149
	24.0711-1361.3	360022
	24.0711-1362.3	360023
	11.8171-0008.1	990049
	24.3220-0909.3	020210
	11.3541-8523.2	220115
	24.3541-8523.5	240551
	11.3541-8523.2	220115
	24.3541-8523.5	240551
	11.3541-8524.2	220116
	24.3541-8524.5	240552
	11.8170-0306.1	260102
	11.8170-0306.1	260102
	13.0460-7081.2	607081
	13.0470-7081.2	LD7081
	13.0460-7081.2	607081
	13.0470-7081.2	LD7081
	11.0441-5409.2	250031
	11.8170-0306.1	260102
	11.8170-0306.1	260102
	11.8116-0143.1	390513
	24.0125-0105.1	425105
	24.0325-0105.1	525105
	24.0111-0130.1	411130
	24.0111-0129.1	411129
	24.0218-5001.1	480012
	24.3727-2701.2	582701
	24.3217-1115.3	020310
	24.5112-0412.3	330569
	24.3727-2705.2	582705
	24.3219-0803.3	020183
	03.0137-0015.2	650015
	24.3219-0803.3	020183
	03.0137-0015.2	650015
	03.0137-0015.2	650015
	24.3727-0503.2	580503
	03.0137-0015.2	650015
	24.0113-0182.1	413182
	13.0460-2964.2	602964
	03.0137-0268.2	650268
	03.0137-0268.2	650268
	24.0220-0018.1	480019
	24.0220-0718.2	480209
	03.0137-9168.2	669168
	03.0137-9168.2	669168
	03.0137-9168.2	669168
	24.0113-0169.1	413169
	24.0125-0105.1	425105
	24.0325-0105.1	525105
	11.0441-5704.2	250034
	11.8170-0306.1	260102
	11.0101-5409.2	260035
	24.0122-0101.1	422101
	24.3384-1603.5	240015
	24.3384-1603.5	240015
	24.3384-1604.5	240016
	24.3384-1604.5	240016
	24.5105-0442.3	331432
	13.0460-4964.2	604964
	24.3217-0908.3	020167
	24.5147-0385.3	331427
	03.2123-1484.3	010595
	24.0120-0128.1	420128
	24.0320-0128.1	520128
	24.3219-0909.3	020188
	24.3217-0908.3	020167
	03.0137-0268.2	650268
	03.0137-0268.2	650268
	03.0137-0268.2	650268
	24.3384-1707.5	240171
	24.3384-1708.5	240172
	03.0137-0268.2	650268
	03.0137-0268.2	650268
	24.0110-0151.1	410151
	24.0310-0151.1	510151
	03.0137-0126.2	650126
	03.0137-0126.2	650126
	03.0137-0126.2	650126
	03.0137-0126.2	650126
	03.0137-0126.2	650126
	03.0137-0126.2	650126
	24.5170-0161.3	331308
	24.0125-0105.1	425105
	24.0325-0105.1	525105
	13.0460-7081.2	607081
	13.0470-7081.2	LD7081
	24.0120-0157.1	420157
	03.0137-0015.2	650015
	03.2120-2031.3	010106
	24.3217-1115.3	020310
	24.5223-0294.3	330576
	24.0111-0130.1	411130
	24.0111-0129.1	411129
	24.0218-5001.1	480012
	24.3727-2701.2	582701
	24.3217-1115.3	020310
	24.5112-0412.3	330569
	24.3727-2705.2	582705
	24.3219-0803.3	020183
	03.0137-0015.2	650015
	24.3219-0803.3	020183
	03.0137-0015.2	650015
	03.0137-0015.2	650015
	24.3727-0503.2	580503
	03.0137-0015.2	650015
	24.0113-0182.1	413182
	13.0460-2964.2	602964
	03.0137-0268.2	650268
	03.0137-0268.2	650268
	24.0220-0018.1	480019
	24.0220-0718.2	480209
	03.0137-9168.2	669168
	03.0137-9168.2	669168
	03.0137-9168.2	669168
	24.0113-0169.1	413169
	24.0125-0105.1	425105
	24.0325-0105.1	525105
	11.8170-0306.1	260102
	11.8170-0306.1	260102
	11.8116-0143.1	390513
	24.0125-0105.1	425105
	24.0325-0105.1	525105
	24.0110-0201.1	410201
	24.0310-0201.1	510201
	11.0441-5704.2	250034
	11.8170-0306.1	260102
	11.0101-5409.2	260035
	24.3219-0909.3	020188
	24.3217-0908.3	020167
	03.0137-0268.2	650268
	03.0137-0268.2	650268

Vergleichsliste

Cross reference list - Tabella di conversione codici

Liste des correspondances - Lista referencias



TALBOT		TOYOTA		TOYOTA				
4248 64	13.0460-3928.2	603928	04491-12322	13.0460-5976.2	605976	04495-12220	03.0137-0313.2	650313
4250 67	13.0460-3928.2	603928	04491-12330	13.0460-5976.2	605976	04495-20090	03.0137-0313.2	650313
432009 00	24.3222-1708.3	020407	04491-12331	13.0460-5976.2	605976	04495-20091	03.0137-0313.2	650313
432030 00	11.0101-5407.2	260011	04491-12421	13.0460-5976.2	605976	04495-20092	03.0137-0313.2	650313
432036 00	11.0441-5402.2	250028	04491-12422	13.0460-5976.2	605976	04495-20100	03.0137-0313.2	650313
432763 00	03.2120-2031.3	010106	04491-12432	13.0460-5976.2	605976	04495-20101	03.0137-0313.2	650313
4402 21	24.3219-1114.3	020323	04491-12440	13.0460-5976.2	605976	04495-20150	03.0137-0313.2	650313
4402 50	24.3222-1102.3	020257	04491-12490	13.0460-5976.2	605976	04495-26020	03.0137-0226.2	650226
4402 52	24.3222-1708.3	020407	04491-12540	13.0460-5976.2	605976	04495-26040	03.0137-0226.2	650226
4402 62	24.3220-0905.3	020207	04491-12541	13.0460-5976.2	605976	04495-26050	03.0137-0308.2	650308
4402 63	24.3220-1115.3	020312	04491-12560	13.0460-5976.2	605976	04495-26051	03.0137-0308.2	650308
4448 34	11.0441-5401.2	250027	04491-12561	13.0460-5976.2	605976	04495-26060	03.0137-0308.2	650308
45164 00	03.3518-6100.2	390364	04491-12580	13.0460-5976.2	605976	04495-26061	03.0137-0308.2	650308
4601 65	24.2119-1503.3	010404	04491-12581	13.0460-5976.2	605976	04495-26080	03.0137-0193.2	650193
47891 00	13.0460-4033.2	604033	04491-12630	13.0460-5976.2	605976	04495-26090	03.0137-0193.2	650193
4861 28	03.6043-0201.3	320026	04491-16052	13.0460-5976.2	605976	04495-26100	03.0137-0308.2	650308
550552 00	24.3219-1114.3	020323	04491-17020	13.0460-5976.2	605976	04495-26120	03.0137-0193.2	650193
559477 00	24.2525-1601.3	040062	04491-17021	13.0460-5976.2	605976	04495-26121	03.0137-0193.2	650193
559477 14	24.2525-1601.3	040062	04491-17022	13.0460-5976.2	605976	04495-32010	03.0137-0313.2	650313
78515310 00	24.0113-0128.1	413128	04491-17030	13.0460-5976.2	605976	04495-32030	03.0137-0313.2	650313
79100193 53	03.6515-1000.3	320089	04491-17040	13.0460-5976.2	605976	04495-32031	03.0137-0313.2	650313
79100289 92	24.3222-1102.3	020257	04491-17050	13.0460-5976.2	605976	04495-33020	03.0137-0318.2	650318
79100344 50	03.6043-0201.3	320026	04491-17060	13.0460-5976.2	605976	04495-34010	03.0137-0308.2	650308
91505280 80	24.2119-1503.3	010404	04491-17061	13.0460-5976.2	605976	04495-35051	03.0137-0226.2	650226
91506320 80	24.3220-1619.3	020246	04491-17070	13.0460-5976.2	605976	04495-35090	03.0137-0226.2	650226
94044483 48	11.0441-5401.2	250027	04491-17080	13.0460-5976.2	605976	04495-35100	03.0137-0226.2	650226
			04491-17081	13.0460-5976.2	605976	04495-35120	03.0137-0226.2	650226
			04491-20191	13.0460-5976.2	605976	04495-35121	03.0137-0226.2	650226
			04491-20220	13.0460-5976.2	605976	04495-35122	03.0137-0226.2	650226
			04491-20310	13.0460-5976.2	605976	04495-35131	03.0137-0193.2	650193
			04491-20390	13.0460-5938.2	605938	04495-35150	03.0137-0308.2	650308
			04491-20451	13.0460-5976.2	605976	04495-35151	03.0137-0308.2	650308
			04491-20470	13.0460-5976.2	605976	04495-35230	03.0137-0308.2	650308
			04491-20471	13.0460-5976.2	605976	04495-42010	03.0137-0318.2	650318
			04491-20500	13.0460-5976.2	605976	04495-42030	03.0137-0318.2	650318
			04491-20501	13.0460-5976.2	605976	04495-42040	03.0137-0318.2	650318
			04491-20580	13.0460-5976.2	605976	04495-42070	03.0137-0318.2	650318
			04491-20620	13.0460-5976.2	605976	04497-26070	03.0137-0308.2	650308
			04491-20820	13.0460-5976.2	605976	04497-26071	03.0137-0308.2	650308
			04491-26030	13.0460-5938.2	605938	04497-26090	03.0137-0308.2	650308
			04491-26040	13.0460-5938.2	605938	04947-32010	13.0460-0325.2	610325
			04491-26070	13.0460-5938.2	605938	04947-32030	13.0460-0325.2	610325
			04491-26130	13.0460-5938.2	605938	04947-32070	13.0460-0325.2	610325
			04491-26151	13.0460-5938.2	605938	04947-32080	13.0460-0325.2	610325
			04491-26191	13.0460-5938.2	605938	04951-05010	11.0101-5407.2	260011
			04491-32010	13.0460-5976.2	605976	42431-12090	24.0109-0128.1	409128
			04491-32011	13.0460-5976.2	605976	42431-12120	24.0109-0128.1	409128
			04491-32030	13.0460-5976.2	605976	42431-14100	24.0118-0119.1	418119
			04491-32080	13.0460-5976.2	605976	42431-14110	24.0118-0119.1	418119
			04491-32190	13.0460-5976.2	605976	42431-14120	24.0118-0119.1	418119
			04491-35050	13.0460-5938.2	605938	42431-20090	24.0110-0241.1	410241
			04491-35060	13.0460-5938.2	605938	42431-20160	24.0110-0241.1	410241
			04491-35061	13.0460-5938.2	605938	42431-33010	24.0110-0700.1	410700
			04491-35070	13.0460-5935.2	605935	42431-35180	24.0229-5004.1	480312
			04491-35080	13.0460-5935.2	605935	43512-07020	24.0128-0115.1	428115
			04491-35160	13.0460-5992.2	605992	43512-12250	24.0118-0110.1	418110
			04491-35200	13.0460-5938.2	605938	43512-12300	24.0118-0110.1	418110
			04491-60010	13.0460-5935.2	605935	43512-12310	24.0118-0110.1	418110
			04491-60040	13.0460-5935.2	605935	43512-12330	24.0118-0110.1	418110
			04491-60050	13.0460-5935.2	605935	43512-12340	24.0118-0110.1	418110
			04491-60080	13.0460-5992.2	605992	43512-12440	24.0118-0110.1	418110
			04491-60110	13.0460-5893.2	605893	43512-12480	24.0118-0110.1	418110
			04492-20100	13.0460-5835.2	605835	43512-12490	24.0122-0188.1	422188
			04492-60010	13.0460-5744.2	605744	43512-16070	24.0118-0124.1	418124
			04492-60020	13.0460-5744.2	605744	43512-16120	24.0118-0124.1	418124
			04495-10110	03.0137-0257.2	650257	43512-20260	24.0122-0153.1	422153
			04495-10120	03.0137-0257.2	650257	43512-20360	24.0122-0178.1	422178
			04495-12110	03.0137-0221.2	650221	43512-20380	24.0122-0178.1	422178
			04495-12111	03.0137-0221.2	650221	43512-20390	24.0125-0144.1	425144
			04495-12171	03.0137-0221.2	650221	43512-26040	24.0125-0118.1	425118
			04495-12210	03.0137-0313.2	650313	43512-26070	24.0125-0118.1	425118



Vergleichsliste

Cross reference list - Tabella di conversione codici



Liste des correspondances - Lista referencias

TOYOTA		VAG		VAG				
43512-32090	24.0122-0154.1	422154	113 611 017 C	03.2119-8711.3	010064	171 698 151 B	13.0460-4029.2	604029
43512-32180	24.0122-0154.1	422154	113 611 017 D	03.2119-8711.3	010064	171 698 151 C	13.0460-4029.2	604029
43512-33020	24.0128-0114.1	428114	113 611 017 E	03.2119-8711.3	010064	171 698 151 D	13.0460-4029.2	604029
43512-33040	24.0128-0115.1	428115	113 611 017 F	03.2119-8911.3	010066	171 698 151 E	13.0460-4028.2	604028
43512-33041	24.0128-0115.1	428115	113 611 017 G	03.2119-8911.3	010066	171 698 151 F	13.0460-7032.2	607032
43512-33042	24.0128-0115.1	428115	113 611 017 H	03.2119-8911.3	010066	171 698 151 G	13.0460-7032.2	607032
43512-33050	24.0128-0114.1	428114	113 611 017 J	03.2119-8711.3	010064	171 698 151 H	13.0460-4029.2	604029
43512-33060	24.0128-0115.1	428115	113 611 017 K	03.2119-8711.3	010064	171 698 447 A	11.0101-4801.2	260006
43512-35070	24.0113-0105.1	413105	113 611 017 L	03.2119-8911.3	010066	171 698 471 A	11.0441-4804.2	250019
43512-35110	24.0120-0168.1	420168	113 611 021 A	03.3119-0507.3	010264	171 698 471 B	11.0441-4808.2	250022
43512-35170	24.0125-0118.1	425118	113 611 021 C	03.3119-0507.3	010264	171 698 545	03.0137-9008.2	669008
43512-35180	24.0125-0118.1	425118	113 611 021 F	03.3117-1408.3	010255	171 721 335 D	24.3728-0107.2	590107
43512-35190	24.0120-0168.1	420168	113 611 021 G	03.3117-1408.3	010255	171 721 335 E	24.3728-0108.2	590108
43512-35200	24.0125-0135.1	425135	113 611 023 B	03.3117-1408.3	010255	172 611 019 A	03.2120-1491.3	010089
43512-44020	24.0128-0115.1	428115	113 611 053	03.3217-0211.3	020021	175 611 025	03.2120-1821.3	010100
43512-44021	24.0128-0115.1	428115	113 611 053 B	03.3217-1811.3	020026	175 611 025 A	03.2120-1821.3	010100
43512-60011	24.0120-0153.1	420153	113 611 055	03.3219-0411.3	020038	175 611 701 A	24.5170-0315.3	331309
43512-60040	24.0120-0153.1	420153	113 611 055 C	03.3219-3211.3	020048	175 615 301	24.0112-0106.1	412106
43512-69015	24.0120-0153.1	420153	113 611 057 B	03.3222-5211.3	020081	175 615 301	24.0312-0106.1	512106
43512-69016	24.0120-0153.1	420153	113 611 701	24.5165-0450.3	331259	175 698 151	13.0460-7032.2	607032
46420-12340	24.3727-1902.2	581902	113 611 701 D	24.5165-0350.3	331257	176 698 151	13.0460-7032.2	607032
47550-20130	24.3219-1712.3	020388	113 611 701 E	24.5230-0285.3	331322	179 609 721	24.3727-0150.2	580150
47550-20141	24.3219-1712.3	020388	113 611 775	24.5224-0240.3	331260	181 609 237 B	03.0137-0041.2	650041
47550-32010	24.3219-1712.3	020388	113 611 775 A	24.5165-0215.3	331319	181 611 701	24.5171-0393.3	331311
47550-39285	24.3219-1712.3	020388	113 611 775 B	24.5224-0295.3	331261	191 501 615 A	24.0220-0018.1	480019
47715-05010	11.8171-0008.1	990049	113 611 775 E	24.5165-0215.3	331319	191 501 615 A	24.0220-0718.2	480209
47716-32010	13.0460-0325.2	610325	113 615 107	13.2401-8007.2	210047	191 501 615 B	24.0218-0007.1	480003
47716-32040	13.0460-0333.2	610333	113 615 107 A	13.2401-8007.2	210047	191 501 615 B	24.0218-0707.2	480211
47717-32010	13.0460-0325.2	610325	113 615 108	13.2401-8008.2	210048	191 609 617 A	24.0223-0017.1	480135
47717-32040	13.0460-0333.2	610333	113 615 108 A	13.2401-8008.2	210048	191 609 721	24.3727-0118.2	580118
47743-32010	13.0460-0325.2	610325	113 698 273	03.0470-2619.2	060051	191 609 721 A	24.3727-0123.2	580123
47743-32030	13.0460-0333.2	610333	113 698 537 QX	03.0137-0041.2	650041	191 609 721 C	24.3727-0166.2	580166
47748-60010	13.0460-0327.2	610327	114 611 015 BC	03.2119-8611.3	010063	191 609 721 D	24.3727-0124.2	580124
47771-12050	13.0460-0333.2	610333	114 611 015 BG	03.2119-9011.3	010067	191 609 721 E	24.3727-0132.2	580132
47771-32010	13.0460-0325.2	610325	114 611 015 BN	03.2119-9011.3	010067	191 609 721 F	24.3727-0133.2	580133
90240-06158	13.0460-0327.2	610327	131 611 055	03.3219-3211.3	020048	191 611 019	03.2120-2031.3	010106
90468-12003	13.0460-0327.2	610327	131 611 057	03.3222-5211.3	020081	191 611 701	24.5170-0315.3	331309
			133 609 721	24.3727-0101.2	580101	191 611 701 A	83.6225-0287.3	330735
			141 615 107	13.2401-8007.2	210047	191 612 107 A	03.6750-0202.4	300033
			141 615 108	13.2401-8008.2	210048	191 612 151	03.6584-0015.3	320109
			147 611 775	83.6299-0807.3	330901	191 612 151 C	03.6584-0015.3	320109
08 30027 004	24.2722-1202.3	020144	147 611 775 A	83.6299-0807.3	330901	191 615 123	24.3481-1745.5	240277
08 30028 005	24.2722-1201.3	020143	171 501 615	24.0218-0007.1	480003	191 615 124	24.3481-1746.5	240278
08 30047 008	24.3215-1201.3	020160	171 501 615	24.0218-0707.2	480211	191 615 423 A	24.3364-1605.5	240011
14 30020 005	24.5110-0155.3	330040	171 501 615 A	24.0218-0007.1	480003	191 615 423 AX	24.3364-1605.5	240011
18 30027 005	24.2722-1201.3	020143	171 501 615 A	24.0218-0707.2	480211	191 615 423 B	24.3384-1603.5	240015
18 30028 006	24.2722-1202.3	020144	171 501 615 B	24.0218-0007.1	480003	191 615 424 A	24.3364-1606.5	240012
18 30047 000	24.3215-1201.3	020160	171 501 615 B	24.0218-0707.2	480211	191 615 424 AX	24.3364-1606.5	240012
			171 501 615 C	24.0218-0007.1	480003	191 615 424 B	24.3384-1604.5	240016
			171 501 615 C	24.0218-0707.2	480211	191 615 601	24.0110-0111.1	410111
111 405 615 B	24.0223-0002.1	480032	171 609 525 A	03.0137-0126.2	650126	191 615 601	24.0110-0275.2	410275
111 405 615 D	24.0223-0002.1	480032	171 609 526 A	03.0137-0126.2	650126	191 615 601 B	24.0110-0111.1	410111
111 698 151 B	13.0460-2905.2	602905	171 609 527 F	03.0137-0126.2	650126	191 615 601 B	24.0110-0275.2	410275
111 698 471	13.0441-4002.2	250074	171 609 528 F	03.0137-0126.2	650126	191 698 151	13.0460-7030.2	607030
111 698 471 A	13.0441-4008.2	250076	171 609 721 C	24.3727-0102.2	580102	191 698 151 A	13.0460-7030.2	607030
111 721 335 C	24.3728-0106.2	590106	171 611 019	03.2120-1531.3	010092	191 698 151 B	13.0460-7033.2	607033
113 407 075	24.0110-0142.1	410142	171 611 019 B	03.2120-1531.3	010092	191 698 151 C	13.0460-7032.2	607032
113 501 615 J	24.0223-0003.1	480033	171 611 019 D	03.2120-1531.3	010092	191 698 151 D	13.0460-7032.2	607032
113 609 237 L	03.0137-0073.2	650073	171 611 019 N	03.2120-1491.3	010089	191 698 151 E	13.0460-7030.2	607030
113 609 537 C	03.0137-0041.2	650041	171 611 051 B	03.3214-0812.3	020011	191 698 151 F	13.0460-7030.2	607030
113 611 015 AH	03.2119-8711.3	010064	171 611 053	03.3214-0812.3	020011	191 698 151 G	13.0460-7033.2	607033
113 611 015 AM	03.2119-9111.3	010068	171 611 053 A	03.3214-0812.3	020011	191 698 151 H	13.0460-7032.2	607032
113 611 015 BC	03.2119-8511.3	010062	171 611 701 A	83.6104-0325.3	330246	191 698 151 J	13.0460-7032.2	607032
113 611 015 BD	03.2119-8711.3	010064	171 611 701 B	83.6104-0325.3	330246	191 698 151 K	13.0460-7032.2	607032
113 611 015 BG	03.2119-8911.3	010066	171 611 701 G	24.5170-0315.3	331309	191 698 447	11.0101-4803.2	260008
113 611 015 BH	03.2119-9111.3	010068	171 611 701 H	24.5170-0315.3	331309	191 698 451	13.0460-2937.2	602937
113 611 015 BL	03.2119-8511.3	010062	171 611 701 K	24.5108-0266.3	330038	191 698 451 A	13.0460-2937.2	602937
113 611 015 BN	03.2119-8911.3	010066	171 611 701 L	24.5170-0315.3	331309	191 698 451 B	13.0460-2937.2	602937
113 611 017	03.2119-8711.3	010064	171 611 775	24.5201-0164.3	331414	191 698 451 C	13.0460-2937.2	602937
113 611 017 A	03.2119-8711.3	010064	171 615 269 B	13.0460-0184.2	610184	191 698 451 D	13.0460-2937.2	602937
113 611 017 B	03.2119-8711.3	010064	171 615 270 B	13.0460-0184.2	610184	191 721 335 AB	24.3728-0121.2	590121

Vergleichsliste

Cross reference list - Tabella di conversione codici

Liste des correspondances - Lista referencias



VAG		VAG		VAG				
191 721 335 C	24.3728-0111.2	590111	1H0 698 545 B	03.0137-9168.2	669168	251 611 021 C	03.2123-0271.3	010164
191 721 335 D	24.3728-0121.2	590121	1H0 927 807	24.0711-1361.3	360022	251 611 775 A	83.7824-0383.3	330856
191 721 335 E	24.3728-0113.2	590113	1H0 927 807 A	24.0721-1937.1	360040	251 611 775 B	24.5224-0440.3	331378
191 721 335 F	24.3728-0120.2	590120	1H0 927 808	24.0711-1362.3	360023	251 615 107	13.2541-8002.2	210111
191 721 335 G	24.3728-0121.2	590121	1H1 611 019 A	03.2120-3943.3	010532	251 615 107 A	13.2541-8002.2	210111
191 721 335 J	24.3728-0113.2	590113	1H1 611 019 B	03.2122-1042.3	010137	251 615 107 B	24.3601-1601.5	240203
191 721 335 M	24.3728-0111.2	590111	1H1 611 019 C	03.2120-3943.3	010532	251 615 108	13.2541-8001.2	210110
191 721 335 N	24.3728-0121.2	590121	1H1 698 019 A	10.6123-0674.3	010639	251 615 108 A	13.2541-8001.2	210110
191 721 335 Q	24.3728-0121.2	590121	1J0 611 053	24.3220-0909.3	020210	251 615 108 B	24.3601-1602.5	240204
191 721 335 R	24.3728-0113.2	590113	1J0 698 151 L	13.0460-7081.2	607081	251 615 123 B	24.3601-1601.5	240203
191 721 335 S	24.3728-0113.2	590113	1J0 698 151 L	13.0470-7081.2	LD7081	251 615 123 C	24.3601-1709.5	240275
191 721 355 A	24.3728-0111.2	590111	1J0 927 803	24.0711-1361.3	360022	251 615 123 D	24.3601-1601.5	240203
191 927 807 A	24.0711-1313.3	360016	1J0 927 804	24.0711-1362.3	360023	251 615 124 B	24.3601-1602.5	240204
191 927 807 D	24.0721-1925.1	360039	200 611 021	03.3119-0507.3	010264	251 615 124 C	24.3601-1710.5	240276
192 611 019	03.2120-2031.3	010106	211 609 537 N	03.0137-0055.2	650055	251 615 124 D	24.3601-1602.5	240204
192 611 019 B	03.2122-1042.3	010137	211 609 615	24.0225-2001.2	480045	251 615 219	11.8171-0008.1	990049
1E0 698 451	13.0460-2984.2	602984	211 609 701 T	24.3727-0107.2	580107	251 698 151	13.0460-6028.2	606028
1E0 698 451 A	13.0460-2937.2	602937	211 611 021 AA	03.2123-2604.3	010178	251 698 151 A	13.0460-6028.2	606028
1E0 698 451 C	13.0460-2984.2	602984	211 611 021 AE	03.2120-8411.3	010125	251 698 151 C	13.0460-2903.2	602903
1E0 698 451 D	13.0460-2984.2	602984	211 611 021 AG	03.2120-8411.3	010125	251 698 151 D	13.0460-6028.2	606028
1E0 698 451 E	13.0460-2984.2	602984	211 611 021 AJ	03.2120-8411.3	010125	251 698 151 E	13.0460-6028.2	606028
1E0 698 451 G	13.0460-2984.2	602984	211 611 021 K	03.2122-0903.3	010136	251 698 151 F	13.0460-2903.2	602903
1GD 698 151	13.0460-7032.2	607032	211 611 021 L	03.2122-0903.3	010136	251 698 447	11.0101-6004.2	260014
1H0 501 615 A	24.0220-0018.1	480019	211 611 021 N	03.2123-2604.3	010178	251 698 471	13.0441-5416.2	250117
1H0 501 615 A	24.0220-0718.2	480209	211 611 021 Q	03.2122-0903.3	010136	251 698 471 B	11.0441-6003.2	250037
1H0 609 721 A	24.3727-0134.2	580134	211 611 021 T	03.2122-2905.3	010141	251 698 477	11.0101-6004.2	260014
1H0 609 721 E	24.3727-0156.2	580156	211 611 047	03.3222-0801.3	020067	251 698 531 LV	03.0137-0148.2	650148
1H0 611 053	24.3219-0909.3	020188	211 611 047 C	03.3222-0801.3	020067	251 698 531 LX	03.0137-0148.2	650148
1H0 611 053 A	24.3215-0903.3	020154	211 611 047 D	03.3223-1112.3	020092	251 698 545	03.0137-9035.2	669035
1H0 611 053 B	24.3214-0902.3	020147	211 611 047 F	03.3223-1112.3	020092	251 721 263 A	03.2525-2711.3	040030
1H0 611 701	24.5105-0442.3	331432	211 611 049 B	24.2725-0903.3	020145	251 721 335	24.3728-0123.2	590123
1H0 611 701 F	24.5105-0442.3	331432	211 611 050 B	24.2725-0904.3	020146	251 721 401 A	03.2419-8212.3	030020
1H0 611 775	83.7836-0135.3	330816	211 611 069 C	24.2725-0903.3	020145	251 721 477 D	24.5803-0325.3	330051
1H0 612 151	03.6584-0107.3	320110	211 611 070 C	24.2725-0904.3	020146	251 798 041	03.0450-2510.2	082510
1H0 612 151 A	03.0101-0025.2	320014	211 611 301 E	03.3508-8302.3	310046	281 609 527 H	03.0137-0259.2	650259
1H0 612 151 C	03.6584-0113.3	320111	211 611 701	24.5165-0425.3	331258	281 609 528 H	03.0137-0259.2	650259
1H0 612 151 D	03.6584-0107.3	320110	211 611 775 A	24.5224-0295.3	331261	281 609 531 J	03.0137-0259.2	650259
1H0 612 151 E	03.6584-0113.3	320111	211 611 775 B	24.5224-0240.3	331260	281 609 617	24.0225-2003.1	480047
1H0 612 151 F	03.6584-0107.3	320110	211 611 775 C	83.6101-0250.3	330203	281 609 701	24.3727-0112.2	580112
1H0 615 301	24.0122-0100.1	422100	211 612 103 A	03.6850-0502.4	300044	281 609 701 B	24.3727-0112.2	580112
1H0 615 301	24.0322-0100.1	522100	211 615 107 A	13.2541-8002.2	210111	281 609 701 C	24.3727-0112.2	580112
1H0 615 301 A	24.0122-0100.1	422100	211 615 108 A	13.2541-8001.2	210110	281 609 702	24.3727-0113.2	580113
1H0 615 301 A	24.0322-0100.1	522100	211 615 301 B	24.0113-0132.1	413132	281 609 702 B	24.3727-0113.2	580113
1H0 615 423	24.3384-1707.5	240171	211 698 151	13.0460-6027.2	606027	281 609 702 C	24.3727-0113.2	580113
1H0 615 423 A	24.3384-1707.5	240171	211 698 151 A	13.0460-6027.2	606027	281 609 702 D	24.3727-0113.2	580113
1H0 615 423 B	24.3384-1707.5	240171	211 698 151 B	13.0460-6027.2	606027	281 611 011	03.2123-5212.3	010183
1H0 615 423 D	24.3384-1707.5	240171	211 698 151 D	13.0460-6027.2	606027	281 611 011 A	03.2123-5212.3	010183
1H0 615 423 DX	24.3384-1707.5	240171	211 698 151 F	13.0460-6027.2	606027	281 611 011 B	03.2125-1712.3	010204
1H0 615 424	24.3384-1708.5	240172	211 698 471	13.0441-5415.2	250116	281 611 011 C	03.2125-1712.3	010204
1H0 615 424 A	24.3384-1708.5	240172	211 698 471 A	13.0441-5416.2	250117	281 611 011 D	03.2123-5212.3	010183
1H0 615 424 B	24.3384-1708.5	240172	211 698 471 C	13.0441-5415.2	250116	281 611 047	03.3225-5511.3	020102
1H0 615 424 D	24.3384-1708.5	240172	211 698 537 SX	03.0137-0055.2	650055	281 611 771	83.6301-0355.3	330343
1H0 615 424 DX	24.3384-1708.5	240172	251 407 615 B	24.0116-0109.1	416109	281 611 771 C	83.6124-0362.3	330715
1H0 698 071	03.0137-0268.2	650268	251 407 615 Q	24.0116-0109.1	416109	281 611 775	24.5224-0299.3	331262
1H0 698 151	13.0460-7032.2	607032	251 407 617	24.0113-0142.1	413142	281 611 775 B	24.5224-0299.3	331262
1H0 698 401	03.0101-0025.2	320014	251 407 617 A	24.0113-0142.1	413142	281 612 105	03.6850-5402.4	300055
1H0 698 451	13.0460-2984.2	602984	251 407 617 D	24.0116-0104.1	416104	281 615 107	24.9257-8027.5	230039
1H0 698 451 A	13.0460-2984.2	602984	251 407 617 G	24.0116-0104.1	416104	281 615 107 B	24.9257-8027.5	230039
1H0 698 451 B	13.0460-2937.2	602937	251 407 617 K	24.0116-0104.1	416104	281 615 108	24.9257-8028.5	230040
1H0 698 451 C	13.0460-2937.2	602937	251 407 617 M	24.0116-0104.1	416104	281 615 108 B	24.9257-8028.5	230040
1H0 698 451 D	13.0460-2984.2	602984	251 609 531 M	03.0137-0148.2	650148	281 615 283 A	24.0120-0114.2	420114
1H0 698 451 E	13.0460-2937.2	602937	251 609 531 P	03.0137-0148.2	650148	281 698 151	13.0460-5701.2	605701
1H0 698 451 F	13.0460-2937.2	602937	251 609 532 M	03.0137-0148.2	650148	281 698 151 A	13.0460-5701.2	605701
1H0 698 451 G	13.0460-2984.2	602984	251 609 532 Q	03.0137-0148.2	650148	281 698 151 B	13.0460-5701.2	605701
1H0 698 451 H	13.0460-2937.2	602937	251 609 615	24.0225-2002.2	480046	281 698 471	13.0441-5720.2	250122
1H0 698 520 V	03.0137-0268.2	650268	251 609 615 A	24.0227-0003.1	480145	281 698 527 GV	03.0137-0259.2	650259
1H0 698 520 X	03.0137-0268.2	650268	251 609 701 A	24.3727-0109.2	580109	281 698 527 GX	03.0137-0259.2	650259
1H0 698 525 V	03.0137-0268.2	650268	251 609 701 B	24.3727-0109.2	580109	281 721 335 E	24.3728-0126.2	590126
1H0 698 525 X	03.0137-0268.2	650268	251 609 701 C	24.3727-0109.2	580109	291 609 527 H	03.0137-0252.2	650252
1H0 698 545	03.0137-9168.2	669168	251 611 021	03.2120-0851.3	010082	291 609 617	24.0227-0001.1	480052
1H0 698 545 A	03.0137-9168.2	669168	251 611 021 B	03.2123-0291.3	010165	291 611 047	03.3225-5512.3	020103



Vergleichsliste

Cross reference list - Tabella di conversione codici



Liste des correspondances - Lista referencias

VAG		VAG		VAG				
291 611 047 A	24.3226-0901.3	020295	331 609 527 F	03.0137-0146.2	650146	3A0 615 124 A	24.3541-8524.5	240552
291 611 047 B	24.3226-0901.3	020295	331 609 528 F	03.0137-0146.2	650146	3A0 615 125	11.8170-0306.1	260102
291 611 771	83.7724-0467.3	331274	331 611 051 A	03.3217-2112.3	020027	3A0 615 125 A	11.8170-0306.1	260102
291 611 775	24.5224-0440.3	331378	331 611 053	03.3217-2112.3	020027	3A0 615 269	11.8116-0143.1	390513
291 615 107	13.9571-0041.2	210259	331 611 053 A	03.3217-2112.3	020027	3A0 615 301	24.0125-0108.1	425108
291 615 107	24.9257-0041.5	230049	357 501 615	24.0223-0012.1	480042	3A0 615 301 A	24.0125-0108.1	425108
291 615 107 B	13.9571-0041.2	210259	357 609 525 C	03.0137-0264.2	650264	3A0 698 151	13.0460-7081.2	607081
291 615 107 B	24.9257-0041.5	230049	357 609 526 C	03.0137-0264.2	650264	3A0 698 151	13.0470-7081.2	LD7081
291 615 108	13.9571-0042.2	210260	357 609 527 E	03.0137-0264.2	650264	3A0 698 151 A	13.0460-7081.2	607081
291 615 108	24.9257-0042.5	230050	357 609 528 E	03.0137-0264.2	650264	3A0 698 151 A	13.0470-7081.2	LD7081
291 615 108 B	13.9571-0042.2	210260	357 609 721	24.3727-0125.2	580125	3A0 698 471	11.0441-5409.2	250031
291 615 108 B	24.9257-0042.5	230050	357 609 721 A	24.3727-0126.2	580126	3A0 698 545	03.0137-9149.2	669149
291 698 527 GV	03.0137-0252.2	650252	357 609 721 C	24.3727-0167.2	580167	3A0 927 807	24.0721-1193.3	360092
291 698 527 GX	03.0137-0252.2	650252	357 609 721 D	24.3727-0126.2	580126	3A1 698 019	03.2123-1424.3	010637
293 609 701 C	24.3727-0120.2	580120	357 609 721 E	24.3727-0126.2	580126	3A1 721 388	03.2419-1206.3	030074
293 609 701 D	24.3727-0120.2	580120	357 611 019	03.2120-3943.3	010532	3A2 698 019	03.2123-1484.3	010595
293 609 701 E	24.3727-0120.2	580120	357 611 019 A	03.2122-1042.3	010137	3B0 615 125	11.8170-0306.1	260102
2D0 609 525	03.0137-4001.2	654001	357 611 019 B	24.3220-0909.3	020210	411 698 151 B	13.0460-4033.2	604033
2D0 609 538	03.0137-4001.2	654001	357 611 053 B	03.7750-4302.4	300076	411 698 471	13.0441-4209.2	250088
2D0 615 601 A	24.0116-0110.1	416110	357 612 107	03.7750-4302.4	300076	431 501 615	24.0223-0007.1	480037
2D0 615 601 D	24.0116-0110.1	416110	357 612 107 A	03.7750-4302.4	300076	431 501 615 A	24.0223-0007.1	480037
2D0 698 451 B	13.0460-3990.2	603990	357 612 151	03.6584-0015.3	320109	431 609 525	03.0137-0264.2	650264
2D0 698 471	11.0441-6007.2	250146	357 612 151 A	03.6584-0015.3	320109	431 609 526	03.0137-0264.2	650264
2D0 698 525	03.0137-4001.2	654001	357 615 123 A	24.3541-1609.5	240039	431 609 527 E	03.0137-0264.2	650264
2D0 698 525 B	03.0137-4001.2	654001	357 615 123 AV	24.3541-1609.5	240039	431 609 528 E	03.0137-0264.2	650264
2D0 919 351	24.8190-0407.2	620407	357 615 123 AX	24.3541-1609.5	240039	431 611 707	83.6124-0362.3	330715
311 405 583 A	24.0110-0142.1	410142	357 615 123 B	24.3541-1731.5	240061	431 611 707 A	83.6134-0332.3	330716
311 611 015 K	03.2119-6713.3	010061	357 615 123 BX	24.3541-1731.5	240061	431 611 775 A	83.7824-0180.3	330812
311 611 015 L	03.2119-6713.3	010061	357 615 123 C	24.3541-1731.5	240061	431 615 301	24.0113-0160.1	413160
311 611 023	03.3119-6457.3	010269	357 615 124 A	24.3541-1610.5	240040	431 615 301 A	24.0122-0118.1	422118
311 611 067 B	03.3222-5011.3	020462	357 615 124 AV	24.3541-1610.5	240040	431 698 071 E	03.0137-0268.2	650268
311 611 067 C	03.3222-5011.3	020462	357 615 124 AX	24.3541-1610.5	240040	431 698 073 E	03.0137-0268.2	650268
311 611 701 B	83.6101-0325.3	330206	357 615 124 B	24.3541-1732.5	240062	431 698 151 D	13.0460-2934.2	602934
311 698 151 A	13.0460-3010.2	603010	357 615 124 BX	24.3541-1732.5	240062	431 698 151 F	13.0460-2934.2	602934
311 698 151 B	13.0460-3010.2	603010	357 615 124 C	24.3541-1732.5	240062	431 698 151 G	13.0460-2934.2	602934
311 698 151 C	13.0460-4033.2	604033	357 615 301	24.0113-0178.1	413178	431 698 471	11.0441-5401.2	250027
311 698 151 E	13.0460-4033.2	604033	357 615 301	24.0313-0178.1	513178	431 721 261	03.2522-4211.3	040017
311 698 471	13.0441-4204.2	250085	357 615 601	24.0110-0111.1	410111	431 721 401 A	03.2419-9610.3	030029
321 609 721 C	24.3727-0108.2	580108	357 615 601	24.0110-0275.2	410275	431 721 401 A	03.2419-9610.3	030029
321 611 053 A	03.3217-2112.3	020027	357 615 601 B	24.0110-0203.1	410203	433 611 707	83.6134-0332.3	330716
321 611 701 B	24.5170-0315.3	331309	357 615 601 B	24.0110-0276.2	410276	433 611 775 A	83.7824-0180.3	330812
321 611 701 D	24.5108-0266.3	330038	357 698 151	13.0460-2958.2	602958	437 611 775	24.5170-0161.3	331308
321 611 775	83.7824-0180.3	330812	357 698 151 A	13.0460-2957.2	602957	437 615 301	24.0122-0120.1	422120
321 612 105	03.7750-0302.4	300071	357 698 151 B	13.0460-2958.2	602958	437 615 301 A	24.0122-0120.1	422120
321 615 301	24.0112-0106.1	412106	357 698 151 D	13.0460-2957.2	602957	437 615 601	24.0110-0154.1	410154
321 615 301	24.0312-0106.1	512106	357 698 525 CV	03.0137-0264.2	650264	437 698 151	13.0460-2934.2	602934
321 615 301 A	24.0120-0123.1	420123	357 698 525 CX	03.0137-0264.2	650264	437 698 451	13.0460-3602.2	603602
321 615 301 A	24.0320-0123.1	520123	357 698 525 V	03.0137-0268.2	650268	441 611 021	03.2125-3210.3	010212
321 615 301 B	24.0120-0123.1	420123	357 698 525 X	03.0137-0268.2	650268	441 611 021 A	03.2125-3210.3	010212
321 615 301 B	24.0320-0123.1	520123	357 721 261	24.2523-0908.3	040049	441 611 021 B	03.2125-3610.3	010214
321 615 301 C	24.0120-0123.1	420123	357 721 261 A	24.2523-0908.3	040049	441 611 707	83.7813-0252.3	330796
321 615 301 C	24.0320-0123.1	520123	357 721 335	24.3728-0124.2	590124	441 612 099 B	10.0124-3202.3	340011
321 615 301 D	24.0120-0128.1	420128	357 721 335 E	24.3728-0124.2	590124	441 612 099 C	10.0124-3202.3	340011
321 615 301 D	24.0320-0128.1	520128	357 721 401	03.2419-9310.3	030027	441 612 101 A	10.0124-3202.3	340011
321 698 151	13.0460-7032.2	607032	357 927 807	24.0721-1925.1	360039	441 612 101 B	10.0124-3202.3	340011
321 698 151 B	13.0460-7033.2	607033	358 612 107	03.7750-4902.4	300079	441 615 301 AA	24.0130-0104.1	430104
321 698 151 C	13.0460-7032.2	607032	358 612 107 B	03.7750-4902.4	300079	441 698 151	13.0460-2847.2	602847
321 698 151 D	13.0460-7033.2	607033	361 611 067 A	03.3223-0611.3	020091	441 698 151 A	13.0460-2847.2	602847
321 698 151 E	13.0460-7033.2	607033	3A0 609 721	24.3727-0153.2	580153	441 698 151 D	13.0460-2847.2	602847
321 698 151 F	13.0460-7032.2	607032	3A0 609 721 A	24.3727-0152.2	580152	441 919 351 A	24.8190-0105.2	620105
321 698 151 G	13.0460-7032.2	607032	3A0 609 721 B	24.3727-0152.2	580152	443 501 615 A	24.0223-0007.1	480037
321 698 151 H	13.0460-7033.2	607033	3A0 609 721 C	24.3727-0152.2	580152	443 501 615 B	24.0223-0011.1	480041
321 698 445	13.0460-0905.2	610905	3A0 611 053	24.3220-0909.3	020210	443 609 525	03.0137-0146.2	650146
321 698 545	03.0137-9041.2	669041	3A0 611 701	24.5147-0385.3	331427	443 609 525 A	03.0137-0264.2	650264
321 721 335 H	24.3728-0114.2	590114	3A0 615 123	11.3541-8523.2	220115	443 609 526	03.0137-0146.2	650146
322 611 019	03.2122-2331.3	010110	3A0 615 123	24.3541-8523.5	240551	443 609 526 A	03.0137-0264.2	650264
322 611 019 A	03.2122-9612.3	010159	3A0 615 123 A	11.3541-8523.2	220115	443 609 527	03.0137-0146.2	650146
323 501 615	24.0220-0018.1	480019	3A0 615 123 A	24.3541-8523.5	240551	443 609 527 A	03.0137-0264.2	650264
323 501 615	24.0220-0718.2	480209	3A0 615 124	11.3541-8524.2	220116	443 609 528	03.0137-0146.2	650146
331 609 525	03.0137-0146.2	650146	3A0 615 124	24.3541-8524.5	240552	443 609 528 A	03.0137-0264.2	650264
331 609 526	03.0137-0146.2	650146	3A0 615 124 A	11.3541-8524.2	220116	443 609 721	24.3727-0119.2	580119

Vergleichsliste

Cross reference list - Tabella di conversione codici

Liste des correspondances - Lista referencias



VAG		VAG		VAG				
443 609 721 A	24.3727-0138.2	580138	447 615 423	24.3434-1701.5	240357	4D0 698 451 B	13.0460-3602.2	603602
443 609 721 E	24.3727-0130.2	580130	447 615 424	24.3434-1702.5	240358	4D0 698 451 F	13.0460-3602.2	603602
443 609 721 G	24.3727-0130.2	580130	447 615 601 A	24.0120-0137.1	420137	4D0 698 451 G	13.0460-3602.2	603602
443 609 721 K	24.3727-0119.2	580119	447 698 151 A	13.0460-2963.2	602963	4D0 698 647	11.0101-5409.2	260035
443 611 019	03.2122-8012.3	010156	447 698 151 B	13.0460-2963.2	602963	531 609 525	03.0137-0126.2	650126
443 611 019 A	03.2122-8012.3	010156	447 698 151 C	13.0460-5403.2	605403	531 609 526	03.0137-0126.2	650126
443 611 021	03.2123-8512.3	010194	447 698 151 E	13.0460-2963.2	602963	531 609 527	03.0137-0126.2	650126
443 611 190	03.3517-5100.1	390326	447 698 151 F	13.0460-2963.2	602963	531 609 528	03.0137-0126.2	650126
443 611 707	83.6134-0332.3	330716	447 698 447	11.0101-5409.2	260035	531 721 335 C	24.3728-0109.2	590109
443 611 707 C	24.5113-0380.3	331344	447 698 451	13.0460-3602.2	603602	533 611 019	03.2122-9812.3	010161
443 611 775	83.6224-0300.3	330730	447 698 451 A	13.0460-3602.2	603602	533 698 151 A	13.0460-2957.2	602957
443 611 775 A	83.6204-0240.3	330718	447 698 451 C	13.0460-3602.2	603602	535 609 721 A	24.3727-0134.2	580134
443 611 775 B	83.6301-0150.3	330342	477 611 775	83.6201-0175.3	330663	535 611 701	24.5237-0333.3	331425
443 611 775 F	24.5113-0220.3	331318	477 612 107 F	03.7750-5702.4	300083	535 615 301	24.0122-0101.1	422101
443 612 099	10.0124-3202.3	340011	477 698 151 A	13.0460-3612.2	603612	535 615 423	24.3384-1603.5	240015
443 612 099 B	10.0124-3202.3	340011	481 611 701	83.6104-0250.3	330720	535 615 423 X	24.3384-1603.5	240015
443 612 099 C	10.0124-3202.3	340011	481 611 775	24.5170-0161.3	331308	535 615 424	24.3384-1604.5	240016
443 614 151 A	03.6585-0108.3	320115	481 611 776	24.5201-0164.3	331414	535 615 424 X	24.3384-1604.5	240016
443 614 151 H	03.6585-0108.3	320115	481 698 151 C	13.0460-5029.2	605029	695 352 631	83.6101-0240.3	330202
443 615 107 C	11.3541-8521.2	220113	481 698 151 E	13.0460-5029.2	605029	6K0 611 701	24.5105-0442.3	331432
443 615 123	24.3541-1609.5	240039	481 698 471	13.0441-3401.2	250044	6N0 611 053	24.3217-0908.3	020167
443 615 123 A	24.3541-1719.5	240057	4A0 501 615 A	24.0223-0014.1	480065	6N0 611 701	24.5147-0385.3	331427
443 615 123 E	11.3541-8521.2	220113	4A0 501 615 B	24.0223-0014.1	480065	6N0 611 701 A	24.5147-0385.3	331427
443 615 123 EX	11.3541-8521.2	220113	4A0 609 721 B	24.3727-0141.2	580141	6N0 611 701 B	24.5147-0385.3	331427
443 615 123 F	24.3541-1719.5	240057	4A0 609 721 C	24.3727-0142.2	580142	6N0 614 019 A	03.2123-1484.3	010595
443 615 123 FV	24.3541-1719.5	240057	4A0 609 721 D	24.3727-0154.2	580154	6N0 615 301 D	24.0120-0128.1	420128
443 615 123 FX	24.3541-1719.5	240057	4A0 609 721 E	24.3727-0141.2	580141	6N0 615 301 D	24.0320-0128.1	520128
443 615 124	24.3541-1610.5	240040	4A0 609 721 F	24.3727-0142.2	580142	6N0 615 601	24.0110-0111.1	410111
443 615 124 A	24.3541-1720.5	240058	4A0 611 019	03.2123-0491.3	010167	6N0 615 601	24.0110-0275.2	410275
443 615 124 F	24.3541-1720.5	240058	4A0 611 019 A	24.2123-1602.3	010384	6Q0 609 525 A	03.0137-0268.2	650268
443 615 124 FV	24.3541-1720.5	240058	4A0 611 019 C	03.2123-0491.3	010167	6Q0 609 525 B	03.0137-0268.2	650268
443 615 124 FX	24.3541-1720.5	240058	4A0 611 019 D	24.2123-1602.3	010384	6Q0 609 526 A	03.0137-0268.2	650268
443 615 301	24.0113-0160.1	413160	4A0 611 021 A	24.2123-1602.3	010384	6Q0 609 526 B	03.0137-0268.2	650268
443 615 301 A	24.0122-0118.1	422118	4A0 611 021 B	03.2123-0491.3	010167	6Q0 609 527 A	03.0137-0268.2	650268
443 615 301 B	24.0122-0118.1	422118	4A0 611 021 D	24.2123-1602.3	010384	6Q0 609 527 B	03.0137-0268.2	650268
443 615 423 A	24.3384-1601.5	240013	4A0 611 707	83.7813-0270.3	330797	6Q0 609 528 A	03.0137-0268.2	650268
443 615 423 AX	24.3384-1601.5	240013	4A0 611 775	24.5113-0209.3	331300	6Q0 609 528 B	03.0137-0268.2	650268
443 615 424 A	24.3384-1602.5	240014	4A0 615 123	24.3571-8505.5	240489	6Q0 611 053 B	24.3219-0909.3	020188
443 615 424 AX	24.3384-1602.5	240014	4A0 615 123 A	24.3571-8507.5	240555	6Q0 611 053 C	24.3217-0908.3	020167
443 615 601	24.0110-0178.1	410178	4A0 615 124	11.3571-8506.2	220126	6Q0 698 525	03.0137-0268.2	650268
443 615 601 A	24.0110-0207.1	410207	4A0 615 124	24.3571-8506.5	240490	6Q0 698 525 A	03.0137-0268.2	650268
443 615 601 B	24.0110-0116.1	410116	4A0 615 124 A	11.3571-8508.2	220128	6Q0 698 525 B	03.0137-0268.2	650268
443 615 601 E	24.0110-0200.1	410200	4A0 615 124 A	24.3571-8508.5	240556	6Q0 698 545	03.0137-9168.2	669168
443 698 151 A	13.0460-2925.2	602925	4A0 615 125 A	11.8170-0306.1	260102	6R0 698 525 A	03.0137-0268.2	650268
443 698 151 C	13.0460-2925.2	602925	4A0 615 269	11.8116-0143.1	390513	6U0 501 615 B	24.0220-0018.1	480019
443 698 151 D	13.0460-2925.2	602925	4A0 615 301 B	24.0115-0105.1	415105	6U0 501 615 B	24.0220-0718.2	480209
443 698 151 F	13.0460-2925.2	602925	4A0 615 301 B	24.0315-0105.1	515105	6U0 611 053 A	24.3222-1712.3	020424
443 698 151 F	13.0460-2934.2	602934	4A0 615 301 C	24.0125-0105.1	425105	6U0 611 053 B	24.3219-1721.3	020422
443 698 151 G	13.0460-2925.2	602925	4A0 615 301 C	24.0325-0105.1	525105	6U0 611 701	24.5166-0325.3	331293
443 698 151 J	13.0460-2925.2	602925	4A0 615 301 D	24.0125-0105.1	425105	6U0 611 701 A	24.5166-0325.3	331293
443 698 151 K	13.0460-2925.2	602925	4A0 615 301 D	24.0325-0105.1	525105	6U0 611 701 B	24.5166-0325.3	331293
443 698 447	11.0101-5409.2	260035	4A0 615 301 E	24.0125-0105.1	425105	6U0 612 151 A	03.6584-0107.3	320110
443 698 451	13.0460-3602.2	603602	4A0 615 301 E	24.0325-0105.1	525105	6U0 615 301	24.0113-0182.1	413182
443 698 451 A	13.0460-3602.2	603602	4A0 615 423	24.3384-1709.5	240257	6U0 698 151	13.0460-2964.2	602964
443 698 451 B	13.0460-3602.2	603602	4A0 615 424	24.3384-1710.5	240258	6U0 698 151 A	13.0460-2964.2	602964
443 698 451 C	13.0460-3602.2	603602	4A0 615 601 A	24.0110-0201.1	410201	6U0 698 525	03.0137-0268.2	650268
443 698 470	11.0101-5403.2	260010	4A0 615 601 A	24.0310-0201.1	510201	6U0 698 525 A	03.0137-0268.2	650268
443 698 471	11.0441-5405.2	250030	4A0 698 151	13.0460-7050.2	607050	6U0 698 545	03.0137-9168.2	669168
443 698 525 BV	03.0137-0264.2	650264	4A0 698 151 B	13.0460-2717.2	602717	7D0 698 471	11.0441-5704.2	250034
443 698 525 BX	03.0137-0264.2	650264	4A0 698 151 C	13.0460-7050.2	607050	7M0 615 423	24.3384-1707.5	240171
443 698 525 CX	03.0137-0264.2	650264	4A0 698 151 D	13.0460-2717.2	602717	7M0 615 424	24.3384-1708.5	240172
443 698 545	03.0137-9044.2	669044	4A0 698 451	13.0460-3602.2	603602	803 611 051	03.3215-0221.3	020013
443 698 647	11.0101-5409.2	260035	4A0 698 471	11.0441-5704.2	250034	803 611 051 A	03.3217-0401.3	020023
443 721 261	03.2522-4211.3	040017	4A0 721 261	03.2522-4300.3	040085	803 611 301	03.3508-8302.3	310046
443 721 335 C	24.3728-0115.2	590115	4A0 721 401	03.2419-9610.3	030029	803 611 707	24.5113-0220.3	331318
443 721 335 D	24.3728-0115.2	590115	4A1 721 401	24.2419-1731.3	030121	803 611 707 B	83.6124-0362.3	330715
443 721 401 A	03.2419-9610.3	030029	4B0 615 125	11.8170-0306.1	260102	803 611 775	24.5113-0220.3	331318
443 919 081 D	10.0522-4005.1	340029	4D0 698 151 B	13.0460-2717.2	602717	803 612 303	03.6058-0301.3	320072
447 611 021	03.2125-2510.3	010209	4D0 698 151 D	13.0460-2717.2	602717	803 698 151 A	13.0460-4033.2	604033
447 615 301 A	24.0125-0102.1	425102	4D0 698 451	13.0460-3602.2	603602	803 698 151 C	13.0460-4033.2	604033
447 615 301 B	24.0125-0102.1	425102	4D0 698 451 A	13.0460-3602.2	603602	803 698 471	13.0441-4801.2	250100



Vergleichsliste

Cross reference list - Tabella di conversione codici

Liste des correspondances - Lista referencias



VAG		VAG		VAG				
803 698 471 C	11.0441-4802.2	250017	857 615 123	24.3541-1719.5	240057	895 615 301	24.0113-0166.1	413166
810 611 707	83.6124-0362.3	330715	857 615 124	24.3541-1720.5	240058	895 615 301 A	24.0122-0108.1	422108
811 609 525 A	03.0137-0146.2	650146	857 615 601	24.0120-0172.1	420172	895 615 301 B	24.0125-0106.1	425106
811 609 526 A	03.0137-0146.2	650146	857 698 451	13.0460-3602.2	603602	895 615 301 D	24.0125-0139.1	425139
811 609 527 A	03.0137-0146.2	650146	857 721 261	03.2522-4211.3	040017	895 615 601 A	24.0110-0261.1	410261
811 609 527 E	03.0137-0146.2	650146	857 721 401	03.2419-8150.3	030019	895 615 601 A	24.0310-0261.1	510261
811 609 528 A	03.0137-0146.2	650146	857 721 401 A	03.2419-8150.3	030019	895 698 151	13.0460-2963.2	602963
811 609 528 E	03.0137-0146.2	650146	857 919 457	10.0522-4005.1	340029	895 698 151 A	13.0460-2963.2	602963
811 609 721	24.3727-0136.2	580136	857 919 457 A	10.0522-4002.1	340028	895 698 151 B	13.0460-2963.2	602963
811 609 721 A	24.3727-0136.2	580136	857 919 457 B	10.0522-4002.1	340028	8A0 609 701 A	24.3727-0191.2	580191
811 609 721 B	24.3727-0136.2	580136	861 609 721 B	24.3727-0103.2	580103	8A0 609 702 A	24.3727-0192.2	580192
811 609 721 C	24.3727-0136.2	580136	861 609 729	24.3727-0146.2	580146	8A0 609 721 AE	24.3727-0148.2	580148
811 609 721 H	24.3727-0136.2	580136	861 611 019 A	03.2117-3311.3	010040	8A0 609 721 AF	24.3727-0147.2	580147
811 609 721 J	24.3727-0136.2	580136	861 611 019 B	03.2120-1531.3	010092	8A0 609 721 T	24.3727-0147.2	580147
811 609 722 A	24.3727-0139.2	580139	861 611 053	24.3219-0909.3	020188	8A0 611 021	03.2123-0491.3	010167
811 609 722 B	24.3727-0139.2	580139	861 611 053 A	03.3215-2311.3	020018	8A0 611 775	83.7812-0200.3	330846
811 609 722 D	24.3727-0139.2	580139	861 611 707	24.5225-0240.3	331321	8A0 611 775 A	83.6212-0160.3	330318
811 609 722 E	24.3727-0139.2	580139	861 611 707 A	83.7734-0290.3	330809	8A0 611 775 D	83.7724-0202.3	330852
811 611 019	03.2120-1531.3	010092	861 611 707 B	83.7734-0290.3	330809	8A0 615 123	24.3541-1743.5	240219
811 611 019 B	03.2120-1531.3	010092	861 611 707 C	83.7734-0290.3	330809	8A0 615 124	24.3541-1744.5	240220
811 611 019 D	03.2120-1531.3	010092	861 615 301	24.0108-0100.1	408100	8A0 615 301	24.0113-0179.1	413179
811 611 019 Q	03.2120-2331.3	010110	861 615 301 B	24.0108-0100.1	408100	8A0 615 301 A	24.0122-0139.1	422139
811 611 775	83.6224-0200.3	330729	861 698 151	13.0460-4028.2	604028	8A0 615 301 D	24.0113-0179.1	413179
811 611 775 A	83.7804-0150.3	330853	861 698 151 A	13.0460-4028.2	604028	8A0 615 301 E	24.0122-0139.1	422139
811 611 817	03.3304-1400.1	390088	861 698 471	11.0441-4402.2	250014	8A0 615 423	24.3384-1701.5	240169
811 612 107 C	03.7750-0302.4	300071	861 721 335 A	24.3728-0101.2	590101	8A0 615 423 X	24.3384-1701.5	240169
811 614 151	03.6565-0101.3	320097	861 721 335 C	24.3728-0118.2	590118	8A0 615 424	24.3384-1702.5	240170
811 615 301	24.0110-0151.1	410151	867 609 525	03.0137-0126.2	650126	8A0 615 424 X	24.3384-1702.5	240170
811 615 301	24.0310-0151.1	510151	867 609 526	03.0137-0126.2	650126	8A0 615 601	24.0110-0182.1	410182
811 698 071	03.0137-0268.2	650268	867 609 527	03.0137-0126.2	650126	8A0 698 151	13.0460-2934.2	602934
811 698 151	13.0460-4028.2	604028	867 609 528	03.0137-0126.2	650126	8A0 698 151 A	13.0460-2934.2	602934
811 698 525 AV	03.0137-0146.2	650146	867 609 701	24.3727-0129.2	580129	8A0 698 151 B	13.0460-2934.2	602934
811 698 525 AX	03.0137-0146.2	650146	867 609 721	24.3727-0137.2	580137	8A0 698 151 C	13.0460-2934.2	602934
823 501 615 B	24.0218-0007.1	480003	867 698 151	13.0460-7059.2	607059	8A0 698 151 E	13.0460-2934.2	602934
823 501 615 B	24.0218-0707.2	480211	867 698 520 X	03.0137-0126.2	650126	8A1 612 099	10.0124-3202.3	340011
823 611 707	24.5170-0315.3	331309	867 698 525 V	03.0137-0126.2	650126	8A2 612 107	03.7750-0302.4	300071
823 615 301	24.0110-0151.1	410151	867 698 525 X	03.0137-0126.2	650126	8D0 611 775 C	83.6212-0160.3	330318
823 615 301	24.0310-0151.1	510151	867 721 335 A	24.3728-0101.2	590101	8D0 611 775 D	24.5113-0220.3	331318
823 698 151	13.0460-4028.2	604028	867 721 335 C	24.3728-0101.2	590101	8D0 698 151	13.0460-2934.2	602934
823 698 151 A	13.0460-4028.2	604028	867 721 335 E	24.3728-0118.2	590118	8D0 698 151 L	13.0460-2934.2	602934
823 698 445	13.0460-0115.2	610115	867 721 335 F	24.3728-0118.2	590118	8E0 615 301 Q	24.0125-0105.1	425105
823 698 471	11.0441-4402.2	250014	867 721 335 H	24.3728-0118.2	590118	8E0 615 301 Q	24.0325-0105.1	525105
827 698 471	11.0441-4402.2	250014	893 501 615	24.0220-0016.1	480018	8E0 615 601	24.0110-0201.1	410201
839 615 301	24.0112-0106.1	412106	893 501 615 A	24.0220-0017.1	480053	8E0 615 601	24.0310-0201.1	510201
839 615 301	24.0312-0106.1	512106	893 609 721	24.3727-0128.2	580128	8E0 615 601 B	24.0110-0261.1	410261
841 501 615 A	24.0220-0018.1	480019	893 609 721 F	24.3727-0143.2	580143	8E0 615 601 B	24.0310-0261.1	510261
841 501 615 A	24.0220-0718.2	480209	893 609 721 G	24.3727-0128.2	580128	8E0 615 601 P	24.0110-0261.1	410261
841 612 151	03.6565-0101.3	320097	893 609 722	24.3727-0127.2	580127	8E0 615 601 P	24.0310-0261.1	510261
841 615 301	24.0120-0123.1	420123	893 609 722 F	24.3727-0144.2	580144	8E0 698 151 A	13.0460-2934.2	602934
841 615 301	24.0320-0123.1	520123	893 609 722 G	24.3727-0127.2	580127	8E0 698 470 B	11.0101-5403.2	260010
849 611 701 G	24.5170-0315.3	331309	893 611 019	03.2122-9612.3	010159	8N0 698 151	13.0460-7081.2	607081
849 611 707 A	24.5170-0315.3	331309	893 611 019 A	03.2122-9612.3	010159	8N0 698 151	13.0470-7081.2	LD7081
853 611 019	03.2122-9612.3	010159	893 611 019 C	24.2122-1601.3	010380	8V0 698 647	11.0101-5407.2	260011
853 611 019 A	03.2122-9612.3	010159	893 611 019 E	03.2122-9612.3	010159	9-8380-57-753	13.0460-3010.2	603010
853 611 021	03.2123-0566.3	010169	893 611 019 F	24.2122-1601.3	010380	J04 465 350 20	13.0460-5938.2	605938
853 611 775	83.6104-0250.3	330720	893 611 021	03.2123-0566.3	010169	J04 465 353 20	13.0460-5938.2	605938
853 612 099	10.0124-3202.3	340011	893 611 021 A	24.2122-1601.3	010380	J04 491 352 00	13.0460-5938.2	605938
853 612 107 A	03.7750-0302.4	300071	893 611 021 B	03.2122-9612.3	010159	J04 495 351 22	03.0137-0226.2	650226
853 612 107 B	03.7750-0302.4	300071	893 611 707	24.5237-0288.3	331442	J43 512 351 80	24.0125-0118.1	425118
853 612 107 D	03.7750-0302.4	300071	893 611 775	83.6104-0250.3	330720	J43 512 351 90	24.0120-0168.1	420168
853 615 301 A	24.0120-0120.1	420120	893 611 775 A	24.5170-0161.3	331308			
853 615 301 C	24.0120-0120.1	420120	893 612 099	10.0124-3202.3	340011			
853 615 423 A	24.3384-1703.5	240055	893 612 107 A	03.7750-0302.4	300071			
853 615 423 AX	24.3384-1703.5	240055	893 612 107 B	03.7750-0302.4	300071			
853 615 424 A	24.3384-1704.5	240056	893 615 108 A	11.3541-8521.2	220113	1205743	24.3727-1313.2	581313
853 615 424 AX	24.3384-1704.5	240056	893 615 124 B	11.3541-8521.2	220113	1205780	24.0114-0101.1	414101
853 615 601	24.0110-0182.1	410182	893 721 261	03.2522-4300.3	040085	1205782	24.0110-0189.1	410189
853 698 151 A	13.0460-2926.2	602926	893 721 261 A	03.2522-4300.3	040085	1205893	03.2022-0111.3	010004
855 698 151 B	13.0460-2936.2	602936	893 721 401 A	03.2522-4300.3	040085	1205894	03.2022-0109.3	010003
857 612 085	10.0515-0515.3	340024	893 721 401 B	03.2419-9210.3	030026	1205977	83.6383-0300.3	330371
857 612 085 A	10.0515-0515.3	340024	893 721 401 D	03.2419-9210.3	030026	1228153	24.0122-0127.1	422127
			894 611 021	03.2123-0566.3	010169	1228272	24.7718-7301.2	990024



Vergleichsliste

Cross reference list - Tabella di conversione codici

Liste des correspondances - Lista referencias



VOLVO		VOLVO		VOLVO				
1228942	24.0114-0101.1	414101	271824	13.0460-3401.2	603401	3267314	24.3219-0903.3	020184
1229100	83.6383-0300.3	330371	271829	13.0460-2935.2	602935	3268705	83.6204-0240.3	330718
1229347	83.6204-0286.3	330733	271831	13.0460-0088.2	610088	3277830	03.0137-0271.2	650271
1229428	03.0137-0169.2	650169	271859	13.0460-7053.2	607053	3287994	24.2120-0912.3	010366
1229549	13.2381-0039.2	210020	271859	13.0470-7053.2	LD7053	3291141	83.6104-0241.3	330731
1229550	13.2381-0040.2	210021	271895	24.0110-0289.1	410289	3293421	03.6058-0501.3	320074
1229551	13.2381-0039.2	210020	271915	24.3728-1301.2	591301	3293451	24.0113-0172.1	413172
1229552	13.2381-0040.2	210021	271958	13.0460-2935.2	602935	3294774	03.6053-0100.3	320053
1229785	24.3727-1306.2	581306	271959	13.0460-3401.2	603401	3296176	24.5113-0280.3	330393
1272323	24.2419-0928.3	030056	271962	13.0460-3403.2	603403	3298167	24.0113-0172.1	413172
1272362	83.6124-0305.3	330723	271979	13.0460-2985.2	602985	3298352	03.6053-0100.3	320053
1273678	24.2419-0928.3	030056	271997	03.0137-0169.2	650169	3342305	03.0137-0271.2	650271
1273681	03.2522-0420.3	040086	271998	03.0137-0260.2	650260	3342533	11.0441-3303.2	250005
1329594	83.6124-0305.3	330723	272134	03.0137-0299.2	650299	3342534	13.0460-3306.2	603306
1329611	83.6134-0335.3	330277	272248	24.0110-0292.1	410292	3342535	11.0101-5402.2	260009
1329740	03.2023-0164.3	010014	272249	03.0137-0449.2	650449	3342536	11.8116-0047.1	390494
1330248	24.2419-0928.3	030056	272288	03.0137-0260.2	650260	3342541	11.8171-0008.1	990049
1330249	24.2419-0928.3	030056	272291	13.0460-2935.2	602935	3342915	24.2120-0912.3	010366
1330310	03.0137-0169.2	650169	272312	24.0126-0102.1	426102	3343365	03.0101-0014.2	320004
1330414	24.9236-0001.5	230005	272343	13.0460-7053.2	607053	3343433	13.0460-2846.2	602846
1330415	24.9236-0002.5	230006	272343	13.0470-7053.2	LD7053	3343436	03.0137-0258.2	650258
1330416	24.9238-0087.5	230035	272365	24.3728-1301.2	591301	3343437	24.3220-1113.3	020224
1330417	24.9238-0088.5	230036	272566	13.0460-2953.2	602953	3343838	13.0460-3010.2	603010
1330418	13.2401-0027.2	210045	272567	13.0460-2954.2	602954	3343931	24.2120-0912.3	010366
1330419	13.2401-0028.2	210046	272604	13.0441-3812.2	250068	3344061	13.0460-2812.2	602812
1330419	24.9240-0028.5	230018	272643	13.0460-0088.2	610088	3344685	11.9541-9806.2	220504
1330799	03.2022-0111.3	010004	272673	13.0460-2953.2	602953	3344689	11.8116-0073.1	390498
1330800	03.2022-0112.3	010005	272691	13.0460-0422.2	610422	3344703	13.0460-7146.2	607146
1359131	24.0122-0127.1	422127	272774	13.0460-3401.2	603401	3344787	13.0460-2812.2	602812
1359156	24.0122-0217.2	422217	272779	13.0460-2953.2	602953	3344984	10.6120-0287.3	010334
1359229	13.2381-0039.2	210020	272780	13.0460-2954.2	602954	3410294	24.0112-0135.1	412135
1359230	13.2381-0040.2	210021	272809	13.0460-2943.2	602943	3412685	83.6124-0285.3	330722
1359290	24.0110-0206.1	410206	272827	13.0460-3914.2	603914	3430032	24.0109-0125.1	409125
1359291	83.6134-0300.3	330725	272831	13.0460-2953.2	602953	3430185	24.3727-1307.2	581307
1359543	03.2023-0503.3	010022	272867	13.0460-2953.2	602953	3430408	83.6104-0336.3	330451
1359906	24.0122-0138.1	422138	272868	13.0460-2954.2	602954	3432616	24.0109-0125.1	409125
1359908	24.0122-0137.1	422137	272871	13.0460-2943.2	602943	3432618	24.0109-0125.1	409125
1387506	03.3517-5100.1	390326	272873	13.0460-2953.2	602953	3446569	83.6104-0295.3	330244
1387779	03.2023-0164.3	010014	272876	13.0460-2954.2	602954	3447432	24.5170-0465.3	331331
1387798	03.0137-0299.2	650299	272903	13.0441-4014.2	250079	3450386	24.0109-0125.1	409125
1387945	13.2401-0027.2	210045	272911	13.0460-3401.2	603401	3450387	24.0220-3015.1	480091
1387946	13.2401-0028.2	210046	273171	03.0137-9173.2	669173	3455719	24.0122-0164.1	422164
1387946	24.9240-0028.5	230018	274267	03.0137-0260.2	650260	3456981	24.3727-1309.2	581309
270163	13.0460-2953.2	602953	274270	03.0137-0260.2	650260	3457229	24.3727-1310.2	581310
270164	13.0460-2954.2	602954	275895	13.0460-2954.2	602954	3459661	24.0112-0135.1	412135
270195	13.0460-2943.2	602943	293421	03.6058-0501.3	320074	3459868	24.3728-1303.2	591303
270736	24.0110-0189.1	410189	298352	03.6053-0100.3	320053	3460736	24.3728-1303.2	591303
270737	24.0114-0101.1	414101	30645136	13.0460-4964.2	604964	3465982	24.0721-1915.3	360149
270739	24.0122-0127.1	422127	30648017	11.8171-0008.1	990049	3465983	24.0721-1916.3	360150
270876	24.0122-0217.2	422217	30648381	13.0460-7053.2	607053	3470372	24.3728-1303.2	591303
270902	13.0441-3815.2	250069	30648381	13.0470-7053.2	LD7053	3485043	24.5170-0465.3	331331
270923	13.0460-2935.2	602935	30666345	03.0137-0449.2	650449	3502522	24.2419-0939.3	030065
271179	13.0460-3914.2	603914	30666829	11.8171-0008.1	990049	3502600	24.2522-0907.3	040043
271182	13.0460-3914.2	603914	30683788	11.0101-5407.2	260011	3516312	10.6123-0445.3	010957
271184	13.0460-2943.2	602943	30683858	13.0460-4964.2	604964	3516317	13.2381-0097.2	210239
271336	13.0460-3401.2	603401	30714429	83.6383-0300.3	330371	3516317	24.9238-0097.5	230037
271349	13.0460-2985.2	602985	30714432	83.6124-0380.3	330268	3516318	13.2381-0098.2	210240
271477	13.0460-3403.2	603403	30793799	13.0460-7053.2	607053	3516318	24.9238-0098.5	230038
271497	24.0110-0216.1	410216	30793799	13.0470-7053.2	LD7053	3516392	03.6055-0431.3	320142
271573	13.0460-2935.2	602935	30872926	24.0124-0136.1	424136	3516530	03.6055-0430.3	320065
271583	11.0441-5702.2	250033	3100021	13.0460-3010.2	603010	3516565	24.3571-1707.5	240079
271584	11.0101-5407.2	260011	3100437	03.3217-0401.3	020023	3516566	24.3571-1708.5	240080
271586	13.0460-3401.2	603401	3104421	83.6104-0220.3	330474	3516567	24.0126-0105.1	426105
271587	13.0460-7053.2	607053	3104998	03.3508-8302.3	310046	3516568	24.5201-0204.3	331400
271587	13.0470-7053.2	LD7053	3107114	03.3508-8302.3	310046	3516840	11.9571-9971.2	220605
271590	24.0126-0101.1	426101	31261183	13.0460-2985.2	602985	3516841	11.9571-9972.2	220606
271737	13.0460-2985.2	602985	31262209	24.0126-0105.1	426105	3516881	03.0137-0260.2	650260
271739	13.0460-2953.2	602953	3202403	03.6055-0303.3	320064	3516987	03.2023-0164.3	010014
271758	13.0460-3403.2	603403	3204990	24.5113-0280.3	330393	3524365	13.2381-0097.2	210239
271788	24.0126-0102.1	426102	3205643	83.6104-0241.3	330731	3524365	24.9238-0097.5	230037
271794	24.0110-0214.1	410214	3210674	24.0113-0172.1	413172	3524366	13.2381-0098.2	210240



Vergleichsliste

Cross reference list - Tabella di conversione codici

Liste des correspondances - Lista referencias

VOLVO 		VOLVO 			
3524366	24.9238-0098.5	230038	8603306	03.2023-0875.3	010890
3524397	83.6134-0270.3	330779	9031502	11.9541-9806.2	220504
3530352	03.2023-0875.3	010890	9031512	11.9541-9806.2	220504
3530354	03.2023-0875.3	010890	9140175	10.6123-0445.3	010957
3530755	24.9236-0001.5	230005	9140392	13.2401-0027.2	210045
3530756	24.9236-0002.5	230006	9140393	13.2401-0028.2	210046
3530757	24.9238-0087.5	230035	9140393	24.9240-0028.5	230018
3530758	24.9238-0088.5	230036	9140449	10.6123-0445.3	010957
3530759	13.2401-0027.2	210045	9140759	24.0126-0102.1	426102
3530760	13.2401-0028.2	210046	9142039	11.9571-9971.2	220605
3530760	24.9240-0028.5	230018	9142040	11.9571-9972.2	220606
3546359	83.6134-0335.3	330277	9157386	83.6124-0380.3	330268
3546381	11.8116-0073.1	390498	9157434	11.9571-9971.2	220605
3546491	13.2381-0097.2	210239	9157435	11.9571-9972.2	220606
3546491	24.9238-0097.5	230037	9157439	13.2381-0097.2	210239
3546492	13.2381-0098.2	210240	9157440	13.2381-0098.2	210240
3546492	24.9238-0098.5	230038	9157440	24.9238-0098.5	230038
3546535	83.6134-0335.3	330277	9157451	24.3571-1707.5	240079
3546590	24.3727-1308.2	581308	9157452	24.3571-1708.5	240080
3546634	03.6055-0430.3	320065	9157737	03.2023-1084.3	010591
3546635	03.6055-0431.3	320142	9157885	03.2023-1044.3	010590
3546813	83.6134-0335.3	330277	9162612	24.0741-1105.1	360195
3549550	24.2419-0939.3	030065	9163880	24.2419-0939.3	030065
436710	03.0101-0014.2	320004	9173299	11.9571-9971.2	220605
4737154	03.3508-4903.3	310032	9173300	11.9571-9972.2	220606
4831249	03.3508-5951.3	310041	9173855	83.6134-0270.3	330779
5002010	13.2381-0039.2	210020	9181017	24.2522-0907.3	040043
5002011	13.2381-0040.2	210021	9209756	24.3727-1308.2	581308
5003514	24.9238-0087.5	230035	9209896	83.6134-0270.3	330779
5003515	24.9238-0088.5	230036	9438036	03.7760-3602.4	300176
5003813	13.2381-0098.2	210240	9438219	13.2401-0027.2	210045
5003813	24.9238-0098.5	230038	9438220	13.2401-0028.2	210046
5003814	13.2381-0097.2	210239	9438220	24.9240-0028.5	230018
5003814	24.9238-0097.5	230037	9485265	11.9571-9971.2	220605
673766	03.2122-1906.3	010761	9485266	11.9571-9972.2	220606
678921	03.2122-1906.3	010761	9485267	13.0460-7053.2	607053
6806787	24.0721-1113.1	360193	9485267	13.0470-7053.2	LD7053
6814279	24.3728-1301.2	591301	9485593	13.0460-7053.2	607053
6814592	24.2520-0905.3	040057	9485593	13.0470-7053.2	LD7053
6814719	24.2419-0941.3	030067			
6819671	03.2023-0503.3	010022	WARTBURG		
6819749	03.2023-0164.3	010014	08 31143 007	24.3219-1201.3	020197
6819771	03.2023-0875.3	010890			
6843128	24.2522-0907.3	040043			
6843913	03.2522-0420.3	040086			
6843914	24.2520-0905.3	040057			
6848902	24.0126-0105.1	426105			
6849311	24.0711-1146.1	360060			
6849312	24.0721-1113.1	360193			
688048	03.3304-0700.1	390082			
8111101	11.9571-9971.2	220605			
8111102	11.9571-9972.2	220606			
8602006	13.2381-0097.2	210239			
8602006	24.9238-0097.5	230037			
8602007	13.2381-0098.2	210240			
8602007	24.9238-0098.5	230038			
8602016	03.2023-0503.3	010022			
8602017	03.2023-0164.3	010014			
8602018	03.2023-0875.3	010890			
8602023	10.6120-0287.3	010334			
8602302	10.6123-0445.3	010957			
8602303	03.2023-1084.3	010591			
8602304	03.2023-1044.3	010590			
8602344	11.9571-9971.2	220605			
8602345	11.9571-9972.2	220606			
8602457	11.9571-9971.2	220605			
8602458	11.9571-9972.2	220606			
8602498	11.9571-9971.2	220605			
8602499	11.9571-9972.2	220606			
8603304	03.2023-0503.3	010022			
8603305	03.2023-0164.3	010014			



A large rectangular area containing 30 horizontal lines, intended for writing or drawing.



Ⓓ Technische Übersetzungen

Ⓔ Technical translations

Ⓕ Traductions techniques

Ⓖ Traducciones técnicas

1-Kammer-Druckluftbremse	single-chamber air brake
1-Kolbensattel D=xx	single-piston caliper D=xx
2-Kolbensattel D=xx	2-piston caliper D=xx
4-Kolbensattel	4-piston caliper
1-Kreis-Bremse	single-circuit brake
2-Kreis-Bremse	two-circuit-brake
1-Kreis-Sättel	single-circuit caliper
2-Kreis-Sättel	two-circuit-caliper
1. Hinterachse	first rear axle
1. und 2. Hinterachse	first and second rear axle
4-Loch-Bremsscheibe	4-bore brake disc
6-Loch-Bremsscheibe	6-bore brake disc
3-Loch-Felge	3-bore wheel rim
4-Loch-Felge	4-bore wheel rim
5-Loch-Felge	5-bore wheel rim
6kt-Schraube	hexagon head screw
6kt-Schraube (innen)	hexagon socket screw
6"-Tandem	6"-tandem
8"-Tandem mit Gabelkopf	8"-tandem with yoke
8"-Tandem ohne Gabelkopf	8"-tandem without yoke
ABS	ABS (anti-lock brake system)
ABS-Dichtungssatz	ABS-gasket kit
Achtung: Kolbenstellung ändern !	attention: change piston position !
Adapter für Bördel E	adapter for bead type E
alle Typen	all types
Alu-Pumpe	alu-pump
Alu-Sättel	alu-calipers
am Bremssattel	on the brake caliper
am Hauptzylinder	on the master cylinder
A-Motor	A engine
Anschlagschraube oben	stop screw, top
Anschluß/Anschlüsse	connection/connections
Anti-Noise-Blech	shim
ASC (Automatische Stabilitäts Control)	ASC (automatic stability control)
ASR (Antriebsschlupfregelsystem)	ASR (traction control system TCS)
ATE nur über VAG erhältlich	ATE only available through VAG
auf Typenschild	on identification plate
aufgeschraubt	screwed on
Auslaß seitlich links	outlet lateral left-hand
Auslaß seitlich rechts	outlet lateral right-hand
außen	outer
automatische Nachstellung	automatic adjustment
Behälter	reservoir
Behälter Doppel-WE	reservoir with double warning device
Behälterbefestigung	reservoir fastening
Behälterstopfen	reservoir plug
Behälterverschraubung	reservoir cap
Behörde	authority cars
Beläge	brake pads
belüftete Scheiben	ventilated discs
Betätigungseinheit	actuation unit
blau	blue
Bodenventil	residual pressure center valve
Bodenventile tauschen	change residual pressure center valve
Bördel x	flare type x
braun	brown
breite Ausführung	wide design
Bremse	brake
Bremsergät	booster unit
Bremskraftregler	brake pressure regulator
Bremsleitungen erneuern !	renew brake lines !
Bremslichtschalter	stop-light switch
Bremsscheiben	brake discs
Bremsschlauch beachten !	notice brake hose !
Buchse + Ausgleichbügel	bushing + compensating clip
Bus	bus (van)
Bypassregler	by-pass regulator
Citroen-Bremse	Citroen-brake
D (Durchmesser) =	D (diameter) =
Dichtring	sealing ring
Dichtung	seal
Dichtungssatz	gasket kit
Differentialsperre	differential lock
Differenzdruckschalter	differential-pressure switch
Differenzdruckventil	differential pressure valve
diverse Typen	various types
Doppelbereifung	twin tyres

frein pneumatique à 1 chambre	freno de aire de 1 cámara
étrier à 1 piston D=xx	mordaza de freno D=xx
étrier à 2 pistons D=xx	mordaza con dos pistones D=xx
étrier à 4 pistons	mordaza con 4 pistones
frein à 1 circuit	freno de 1 circuito
frein à deux circuits	freno de 2 circuitos
étriers frein à 1 circuit	pinza de 1 circuito
étriers frein à 2 circuits	pinza de 2 circuitos
1. essieu arrière	1. eje trasero
1. et 2. essieu arrière	1. + 2. eje trasero
disques de frein à 4 trous	disco freno con 4 taladros
disques de frein à 6 trous	disco freno con 6 taladros
jante à 3 trous	Llantas de 3 taladros
jante à 4 trous	Llantas de 4 taladros
jante à 5 trous	Llantas de 5 taladros
vis hex.	tornillo hexagonal
vis hex. (intérieure)	tornillo hexagonal (interior)
6"-tandem	6"-tándem
8"-tandem avec chape	8"-tándem con cabeza de horquilla
8"-tandem sauf chape	8"-tándem sin cabeza de horquilla
ABS (système anti-blocage)	ABS (sistema de frenado antibloqueo)
jeu de joints de ABS	juego de reparación de juntas ABS
attention: position du piston à changer !	atención: cambiar posición pistón !
adaptateur pour colet E	adaptador para rebordes E
tous types	todos tipo
pompe en alu	bomba de aluminio
étriers en alu	mordaza de freno de aluminio
sur l'étrier de frein	a la pinza de freno
sur le maître-cylindre	a la bomba principal de freno
moteur A	motor de A
vis de butée en haut	tornillo de tope arriba
raccordement/raccordements	conexion/conexiones
tôle anti-bruit	placa anti-ruidos
ASC (contrôle de stabilité)	ASC (control automático de estabilidad)
ASR (anti-patinage)	ASR (sistemas antiderrapaje)
ATE (Teves) en vente chez VAG seulement	ATE solamente através de VAG
sur plaque d'identification	placa de identificación
vissé	fijado
échappement latéral gauche	salida lateral izquierda
échappement latéral droit	salida lateral derecha
mâle	exterior
ajustage automatique	reajuste automatico
réservoir	recipiente
réservoir avec témoin d'usure double	recipiente con doble aparato de aviso
fixation réservoir	recipiente de fijación
bouchon de réservoir	tapon
vissage de réservoir	fijación depósito
véhicule communal	vehiculos oficiales
plaquettes de frein	pastillas de freno
disques ventilés	disco ventilado
unité de commande	unidad de accionamiento
bleu	azul
soupape de pression résiduelle	válvula de fondo
soupape de pression résiduelle à changer	cambiar válvula de fondo
colet x	reborde x
marron	marron
exécution large	variante ancha
frein	freno
servo-frein	servofreno
correcteur de freinage	corrector de frenado
conduits de frein à renouveler !	renovar latiguillos de freno !
contacteur stop	interruptor de luz de freno
disques de frein	discos de freno
faire attention flexible de frein !	atención al latiguillo de freno !
douille + étrier de compensation	casquillo + estribo de compensación
autobus/car	autobus
régulateur à by-pass	regulador de by-pass
freins Citroen	freno Citroen
D (diamètre) =	D (diámetro) =
rondelle d'étanchéité	reten
joint	junta
jeu de joints	juego de reparación de juntas
blocage de différentiel	bloqueo diferencial
interrupteur à pression différentielle	interruptor de presión diferencial
pression différentielle de soupape	valvula de presión diferencial
types diverses	diversos tipo
pneu double	cubierta doble

Doppelkabine	double cab
Druckbegrenzungsventil	pressure limiting valve
Druckbolzen	tappet
Druckbolzen (kurz)	tappet (short)
Druckbolzen (lang)	tappet (long)
Druckluftbremse	air brake
Druckluftleitung	compressed-air line
Druckluftunterstützung	air brake assistance
Druckluftverstärker	air brake booster
Druck-Warnschalter	pressure warning switch
DS-Regler	DS-valve
EDS	EDS (electronic differential lock)
EDS-Ventilblock	EDS-valve block
EG-Vorschrift	accordance with EC regulation
Einbau hinter der Achse	installation aft of axle
Einbau vor der Achse	installation forward of axle
Einbausatz	installation kit
Einfachbereifung	single tyre
Einknöpfmaß xx mm	button-in dimension xx mm
Einlaß D=xx mm	inlet diameter=xx mm
Einlaß mit Gummistopfen	inlet with rubber plug
Einschraubregler	screw-in proportioning valve
elektr. Vergaser	electr. carburetor
Entlüfteranschluß	bleeding connection
Entlüfterventil	bleeder valve
erhöhte Zuladung	increased payload
Ersatz für Sättel D=xx	replacement for calipers D=xx
ETS	ETS (electronic trac control system)
Europa	Europe
Export	Export
Fahrschule	driving school
Faltenbalgsatz	bellow seal set
Faustsättel	fist-type calipers
Fenster	window
Festsättel	fixed calipers
Flanschdicke x mm	flange thickness x mm
Flanschmaß = xx,x	flange dimension = xx,x
Fuller-Getriebe	fuller-gearbox
für Belagsätze ohne Zubehör	for brake pads without accessories
für Bremssättel/Vorgänger	for calipers/predecessor
für Doppelmembran-Gerät	for twin diaphragm booster
Gabelkopfsatz	yoke kit
Gehäuse L=	housing L=
gelb	yellow
gepanzerte Fahrzeuge	armoured vehicles
Getriebe	gearbox
Getriebe-Nr.	gearbox-no.
GG-Pumpe	cast-iron-pump
GG-Sättel	cast iron-caliper
GG-THz/Vorgänger	cast-iron-TMC/predecessor
Golf-Staaten	Gulf States
Gz mit senkrechtem Flansch	CC with vertical flange
Gz (Geberzylinder)	CC (clutch cylinder)
Gz-Reparatursatz	CC-repair kit
HA (Hinterachse)	RA (rear axle)
Haltefeder	retaining spring
Halter	anchor
Haltersatz	anchor set
Halterschraube	anchor screw
Handbremsbetätigung	hand brake actuation
Handbremshebel	handbrake lever
HA-Scheibenbremse	rear axle disc brake
HA-Trommelbremse	rear axle drum brake
Hebel	lever
Hochdach	high roof
Hohlschraube	hollow screw
Hosei-Bremse	Hosei brake
Hub	stroke
Hülsensatz	sleeve kit
Hydraulikspeicher	hydraulic accumulator
Hydraulikverstärker	hydraulic booster
Hydraulikzylinder	hydraulic cylinder
Hydr. Steuereinheit	hydraulic unit
Hz (Hauptzylinder)	MC (master cylinder)
Hz-Reparatursatz	MC-repair kit
im Fahrerhaus	in cab
im Motorraum	in engine compartment

cabine double	cabina doble
soupape à réglage de pression	válvula de limitación de presión
boulon de pression	perno de presión
boulon de pression (court)	perno de presión (corto)
boulon de pression (long)	perno de presión (largo)
frein à pneumatique	freno de aire comprimido
conduite pneumatique	aire comprimido de flexible
assistance à pneumatique	freno de aire auxiliar
amplificateur à pneumatique	servo de aire a presión
avertisseur d'alerte de pression	interruptor de aviso de presión
correcteur de DS	regulador DS
EDS (blocage de différentiel électronique)	EDS (bloqueo diferencial electrónico)
EDS-bloc de vannes	EDS válvula de bloqueo
aux prescriptions CEE	según normativa CEE
montage derrière l'essieu	instalación después del eje
montage devant l'essieu	instalación antes del eje
lot de montage	juego de montaje
pneu simple	cubierta simple
mesure à boutonner xx mm	medida de alojamiento xx mm
admission diamètre=xx mm	admisión diámetro = xx mm
admission avec bouchon de caoutchouc	admisión con tapon de goma
compensateurs à visser	regulador roscado
carburateur électrique	carburador eléctrico
raccordement de purge	conexión de purga
soupape de purge	válvula de purga
charge utile augmentée	incremento de carga
remplacement pour étriers D=xx	sustitución para pinzas D=xx
ETS (contrôle trajectoire)	ETS (sistema de control electr. de tracción)
Europe	Europa
Export	Exportación
auto-école	escuela de conducción
jeu de joints-soufflets	juego de reparac. de suspensión neumática
étriers à griffe	pinza de puno
fenêtre	ventana
étriers fixes	pinza de fija
épaisseur de la bride x mmm	grosor de la brida x mm
dimension de la bride = xx,x	medida de brida = xx,x
boîte à vitesse fuller	Fuller caja de cambios
pour garnitures de frein sauf accessoire	para juego de pastilla sin accesorios
pour étriers de frein/prédécesseur	para pinza/avisador
pour appareil à double membrane	para servo freno con doble membrana
jeu de chape	juego de cabeza de horquilla
corps L=	carcasa L=
jaune	amarillo
véhicule blindé	vehículo blindado
boîte de vitesse	caja de cambios
no. boîte de vitesse	número de caja de cambios
pompe en fonte/prise	bomba de fundición de gris
étriers en fonte/prise	pinza de fundición de gris
MCT fonte/prise/prédécesseur	cil. principal de fundición de gris/avisador
pays du Golfe Persique	estados del Golfo Pérsico
émetteur d'embrayage avec bride	cilindro distribuidor con brida vertical
EE (émetteur d'embrayage)	CTR (cilindro distribuidor)
néc. de réparation EE	juego de reparación de juntas CTR
AR (essieu arrière)	HA (eje trasero)
ressort à retenu	muelle de sujeción
support	soporte
jeu de support	juego de soporte
vis de support	tornillo de soporte
frein à main	activación de freno de mano
levier de frein à main	palanca freno de mano
frein à disque essieu AR	eje trasero disco de freno
frein à tambour essieu AR	eje trasero tambores de freno
levier	palanca
toit surélevé	techo sobrealzado
vis creuse	tornillo hueco
freins Hosei	freno de Hosei
course	elevación
jeu de douilles	juego de vaina
accumulateur hydraulique	acumulador de hidráulico
amplificateur hydraulique	servo hidráulico
cylindre de hydraulique	cilindro de hidráulico
modulateur	modulador de hidráulico
MC (maître cylindre)	CM (cilindro maestro)
néc. de réparation MC	juego de reparación CM
dans la cabine du conducteur	en cabina
dans compartiment moteur	en compartimento de motor

innen	inside
Innengewinde	inner thread
Kastenwagen	van
Katalysator	catalytic converter
Kennzeichen: xx	registration number: xx
Kerbe am Flansch	notch on flange
Klasse	class
Kleinbus	minibus
Klimaanlage	air conditioning
Kolbenstange D=	piston rod diameter=
Kolbenstange L=	piston rod length=
Kombiwagen	station wagon
Kompakt THz	compact TMC
Krankenwagen	ambulance
Kupplung	clutch
Kupplungsabgang	outlet port for clutch connection
Kupplungsverstärker	clutch booster
kurzer Radstand	short wheel base
kurzes Bremsgerät	short brake booster
L (Länge) =	L (length) =
langer Radstand	long wheel base
Leckageanzeige	leakage indicator
lieferbar	available
links oben und rechts unten	upper left and lower right
links vor und rechts hinter der Achse	left in front and right behind axle
Linkslenker	left hand drive
Luftfederung	pneumatic suspension
luftgekühlt	air-cooled
M8-Führungsbolzen	M8-guide pin
MA-Getriebe	MA gearbox
mit 1 Haltestift	with 1 retaining pin
mit 2 Haltestiften	with 2 retaining pins
mit Alufelgen	with alu wheel rim
mit angegossenem Behälter	with cast-on reservoir
mit geregelter Katalysator	with controlled catalytic converter
mit Laschen	with straps
mit Leichtmetallrädern	with light alloy rims
MKII-Aggregat kpl.	MKII complete unit
Mod. (Modell)	Mod. (model)
Motor	engine
Motor-Nr.	engine number
Motor-Pumpen-Aggregat	motor pump unit
Multi-Link-Achse	multi-link axle
m.Z. (mit Zubehör)	m.Z. (with accessories)
Nachstellteile-Satz	adjuster parts set
ND-Schlauch	ND low pressure hose
Nebenabtrieb	power take-off
Niveauregulierung	suspension level-control
Nz (Nehmerzylinder)	SC (slave cylinder)
Nz-Reparaturatz	SC-repair kit
ohne Alufelgen	without alu wheel rim
ohne geregelten Katalysator	uncontrolled catalytic converter
ohne Laschen	without straps
ohne Leichtmetallräder	without light alloy rim
O-Ring	O-ring
Pedal Feststeller	lockable pedal
Polizei	Police
Rad	wheel
Radsensor	wheel sensor
Radstand xxxx mm	wheel base xxxx mm
rechts oben und links unten	upper right and lower left
Rechtslenker	right hand drive
Regler	regulator
Reihenmotor	R engine
Reisebus/Hochdecker	tourist bus/high decker
Reparaturatz	repair kit
Ringstutzen-Satz	ring type nipple set
Rohrleitung	pipe line
rot	red
roter Sattel	red caliper
Rückschlagventil	non-return valve
Rückstellwellen-Satz	resetting shaft set
Rz (Radzylinder)	WC (wheel cylinder)
Rz-Dichtungssatz	WC-seal kit
Rz-Reparaturatz	WC-repair kit
Salisbury-Achse	Salisbury axle
Sattel mit 1 Haltestift	caliper with 1 retaining pin

intérieur	interior
taraudage intérieure	rosca interior
fourgonnette	furgon
catalyseur	catalizador
indice: xx	distintivo: xx
entaille sur la bride	muesca en brida
classe	clase
petit autobus	mini-bus
air conditionné	aire acondicionado
tige de commande diamètre=	varilla de pistón diámetro =
tige de commande longueur=	varilla de pistón largo=
voiture familière	break (familiar)
MCT compact	cilindro maestro tandem compacto
véhicule à ambulance	ambulancia
embrayage	embrague
sortie d'embrayage	salida conexión embrague
amplificateur d'embrayage	refuerzo embrague
empattement court	distancia corta entre ejes
servo-frein court	servofreno corto
L (longueur) =	L (largo) =
empattement long	distancia larga entre ejes
avertissement de fuite	indicador pérdida liquido de freno
disponible	suministrable
à gauche, en haut et à droite, en bas	izquierda arriba + derecha abajo
à gauche devant essieu et à droite derrière essieu	izquierda adelante+derecha atrás de eje
direction à gauche	volante a la izquierda
suspension pneumatique	suspensión neumática
refroidir par air	refrigeración por aire
boulon de guidage M8	perno de guía M8
boîte de vitesse MA	caja de cambios MA
avec 1 bouchon d'arrêt	con 1 pasador
avec 2 bouchon d'arrêts	con 2 pasadores
avec jante en alu	con Llantas de aluminio
réservoir en fonte commun	con depósito anadido
avec cataliseur réglé	con catalizador regulado
avec collier	con brida
avec jantes en aluminium	con Llantas de aluminio
agrégat MKII complet	MKII sistema completo
Mod. (modèle)	Mod. (modelo)
moteur	motor
numéro de moteur	número de motor
agrégat moteur pompe	systema motor-bomba
essieu multi-link	eje Multi-Link
m.Z. (avec accessoire)	m.Z. (con accesorios)
jeu de pièces d'ajustage	juego de acoplamiento
flexible de ND	ND flexible
propulsion secondaire	potencia adicional
correcteur d'assiette	regulación de altura de suspensión
RE (récepteur d'embrayage)	CRE (cilindro receptor)
néc. de réparation RE	juego de reparación de juntas CRE
sauf jante en alu	sin Llantas de aluminio
sauf cataliseur réglé	sin catalizador regulado
sans collier	sin brida
sauf jantes en aluminium	sin Llantas de aluminio
joint torique	junta torica
fixation des pédales	eje pedal
Police	Police
roue	rueda
capteur de roue	sensores de rueda
empattement xxxx mm	distancia entre rueda xxxx mm
à droite, en haut et à gauche, en bas	derecha arriba + izquierda abajo
direction à droite	volante a la derecha
régulateur	regulador
moteur en ligne	motor de R
autobus/car avec cabine élevée	autobús
néc. de réparation	juego de reparación
jeux de raccord annulaire	juego de tubuladura anular
conduite tube	latiguillo
rouge	rojo
étrier rouge	pinza roja
clapet antiretour	valvula de retención
jeu d'arbres de rappel	juego de onda de retroceso
CR (cylindre roue)	CR (cilindro de rueda)
jeu de joints CR	juego de reparación de juntas CR
néc. de réparation CR	juego de reparación CR
essieu Salisbury	Salisbury eje
étrier avec 1 bouchon d'arrêt	pinza con 1 pasador

Sattel mit 2 Haltestiften	caliper with 2 retaining pins
Sättel mit Gussnoppen	calipers with cast-naps
Sattelschraube	caliper screw
Scheibenbremse	disc brake
Scheibenkupplung	disc clutch
Scheibenschraube	disc screw
Schlauchleitung	line hose
Schraubstutzen	screw neck
schwarz	black
Schwimmsättel	floating caliper
Schwingblech WE	sheet metal warning device
SCS	SCS (stop control system)
separater Behälter	separate reservoir
separates Druckstück/Vorgänger	separate thrust member/predecessor
Servolenkung	power steering
Skandinavien	Scandinavia
Sitzplätze	seats
Sonderfahrzeuge	special vehicle
Spezialaufbau	special body
Sportfahrwerk	sports suspension
Spur	track
Standard-Bremsgerät	standard booster unit
Standard-THz	standard tandem master cylinder
staubfeste Ausführung	dustproof design
Stufenheck	saloon
T50-Reparatursatz	T50-repair kit
Tandemregler	tandem proportioning valve
THz mit 3 Anschlüssen	TMC with 3 connections
THz mit Anschlagsschraube	TMC with stop screw
THz (Tandemhauptzylinder)	TMC (tandem master cylinder)
THz-Reparatursatz	TMC-repair kit
THz-RS (Montagehülse)	TMC-repair kit (assembly sleeve)
Timken-Achse	Timken axle
Topfmanschette	pot seal
Tragbolzensatz	supporting bolt set
Transporter	transporters
Triebkopf	drive head
Trommelbremse	drum brake
TBB (Trommelbremsbacken)	DBS (drum brake shoes)
Umbau 1-teilig auf 2-teilig	reconstruction 1-piece to 2-piece
Unterdruckverstärker	vacuum booster
ursprüngl. verschraubte Beläge	initial screwed pads
VA (Vorderachse)	FA (front axle)
VA-Girling-Bremse	front axle girling-brake
VA-Scheibenbremse	front axle disc brake
VA-Trommelbremse	front axle brake drums
Ventilblock	valve block
Ventilblock kpl.	valve block complete
Verbindungsschrauben	connection screws
Verschlusschraube	screw plug
Verschraubung	screw fitting
Verschraubung kpl.	screw fitting cpl.
verstärkte Bremse	heavy-duty brake
verstärkte Stoßdämpfer	reinforced dampers (shock absorber)
verstärktes Fahrwerk	reinforced suspension
Verteilerstück wiederverwenden	reuse distributor piece
V-Motor	V engine
Vorder- und Hinterachse	front and rear axle
Vorderachse	front axle
Vorderachse und 2. Hinterachse	front axle and second rear axle
Vordruckventil	residual pressure valve
Vorgänger	predecessor
Vorgänger / Abschirmkappe	predecessor / deflector cap
Vorgänger-THz, Einlaß D=xx	predecessor-TMC, inlet diameter=xx
Vorspannzylinder	pre-loaded cylinder
WK (Warnkontakt)	WI (wear indicator)
Warnkontakt 1-polig	wear indicator single connector
Warnkontakt 2-polig	wear indicator twin connector
Warnschalter	warning switch
WE (Warneinrichtung)	WD (warning device)
WE-Befestigung	WD fixture
Wegsensor	travel sensor
weiß	white
Zylinderschraube	cylinder screw

étrier avec 2 bouchon d'arrêt	pinza con 2 pasadores
étriers avec nopes en fonte	pinzas con protuberancias de fundición
vis d'étrier	tornillo de pinza
disques de frein	disco de freno
embrayage du disque	disco de embrague
disque vis	tornillo de disco
conduite flexible	latiguillo flexible
raccordement à vis	tornillo de fijación
noir	negro
étrier flottant	pinza flotante
tôle oscillante dispositif d'avertissement	chapa para avisador de desgaste
SCS (système de contrôle stop)	SCS (sistema de control de frenada)
réservoir séparé	depósito independiente
pièce d'appui/prédécesseur	tubería de presión independiente/avisador
direction assistée	dirección asistida
Scandinavie	Escandinavia
sièges	plazas
véhicule spécial	vehículos especial
carrosserie spéciale	construcción carrocería especial
châssis sport	suspensión deportiva
voie	distancia entre ruedas
servo-frein standard	servo freno standard
MC-tandem standard	cilindro tandem standard
exécution anti poussière	versión antipolución
à coffre	parte trasera escalonada
néc. de réparation T50	juego de reparación T50
compensateur tandem	tandem regulador
MCT avec 3 raccords	cilindro tandem con 3 conexions
MCT avec vis de butée	cilindro tandem con tornillo de tope
MCT (maître cylindre tandem)	CMT (cilindro tandem)
néc. de réparation MCT	juego de reparación CMT
néc. de réparation MCT (douille d'assemblage)	juego de reparación CMT (vaina de montaje)
essieu Timken	Timken eje
coupelle	retén
jeu de boulons de suspension	juego de tornillo de soporte
transporter	furgoneta
tête de propulsion	grupo motriz
frein à tambour	tambores de freno
SGT (mâchoires de frein à tambour)	ZDF (zapatas de freno)
reconstruction 1 partie sur 2 parties	reconstrucción de 1 a 2 piezas
amplificateur à dépression	amplificador de depresion
à l'origine garnitures vissés	pastillas inicialmente montadas
VA (essieu avant)	VA (eje delantero)
frein à girling essieu avant	eje delantero - Girling freno
frein à disque essieu avant	eje delantero - disco de freno
tambours de frein essieu avant	eje delantero - tambores de freno
bloc de vannes	válvula de bloqueo
bloc de vannes complet	bloque de valvulas completo
vis de raccordement	tornillo de conexión
vis de fermeture	tornillo de cierre
couvercle	tornillo de fijación
couvercle complet	fijación completa
frein renforcé	freno reforzado
amortisseurs renforcés	amortiguadores reforzados
châssis renforcé	suspensión reforzada
distributeur à remettre	distribuidor de reemplazo
moteur en V	motor de V
essieu avant et essieu arrière	eje delantero + eje trasero
essieu avant	eje delantero
essieu avant et 2. essieu arrière	eje delantero + 2. eje trasero
soupape pression d'admission	válvula de presión previa
prédécesseur	predecesor
prédécesseur/défecteur	predecesor / tapa deflector
MCT prédécesseur, admission diamètre=xx	predecesor cilindro principal, admision D=xx
cylindre relais	cilindro preajustado
TU (témoin d'usure)	CD (contacto de desgaste)
témoin d'usure 1-borne	contacto de desgaste con 1 conexión
témoin d'usure 2-bornes	contacto de desgaste con 2 conexiones
interrupteur d'avertissement	interruptor de desgaste
DA (dispositif d'avertissement)	DD (dispositivo de desgaste)
fixation de DA	fijación del dispositivo de desgaste
capteur de course	sensor de ruta
blanc	blanco
vis cylindre	tornillo cilindrico



A large rectangular area containing 25 horizontal lines, intended for writing or drawing.

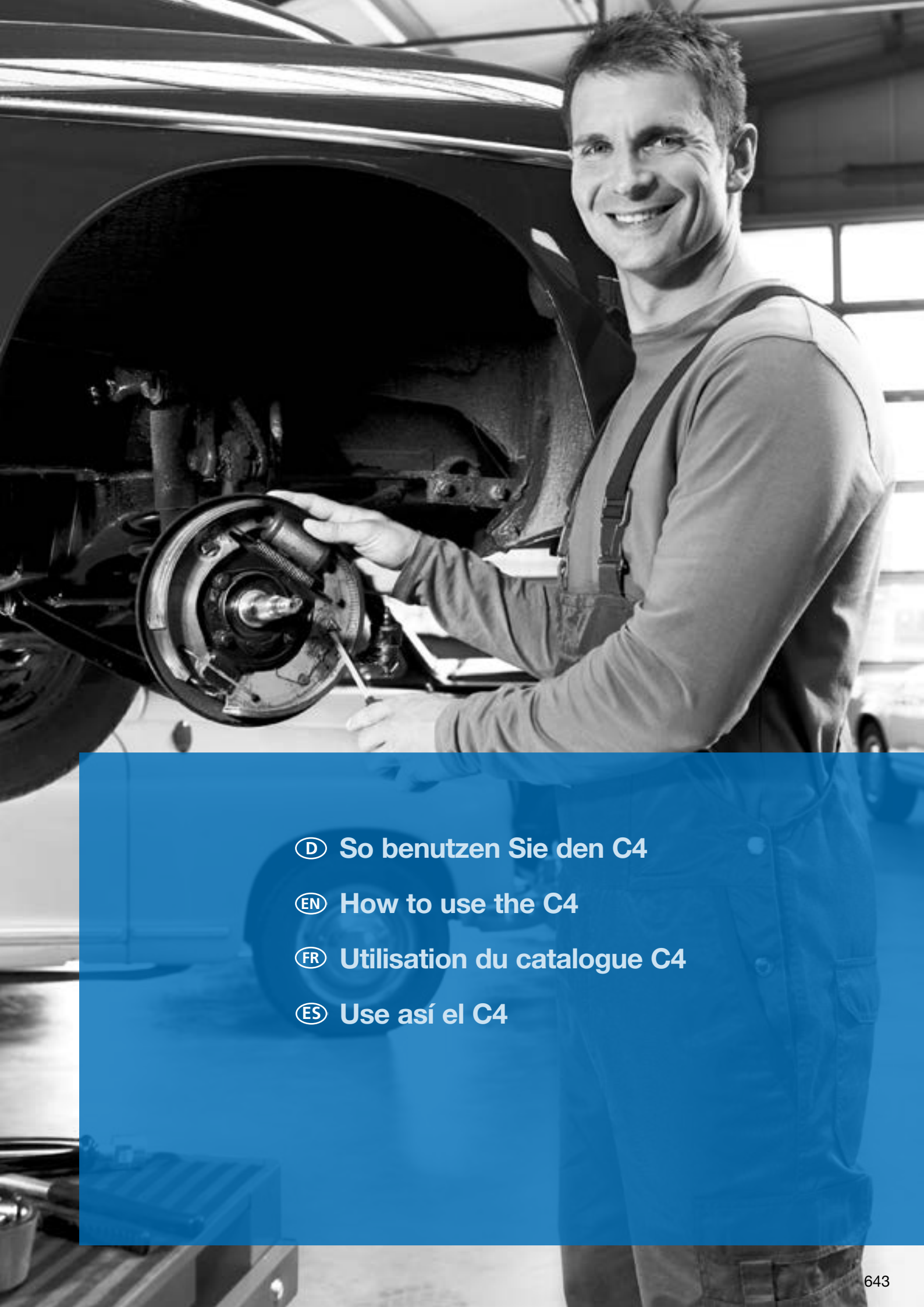

Ⓛ So benutzen Sie den C4

Ⓛ How to use the C4

Ⓛ Utilisation du catalogue C4

Ⓛ Use así el C4

How to use the C4

Product groups		Type of vehicle		Installation period (from/to)		ATE number		Remark (spare part)			
Front/rear axle		Chassis number		Remark (car)		Short number		Definition			
		kW									
AUDI A4 CABRIO (02-)											
	1,8 T 1,8 T Quattro 2,0 2,0 TFSI	◀ 120 ◀ 120 ◀ 96 ◀ 120	8E-55-999999 8E-55-400001	04.02 05.03 08.06 08.06	PR: 1LB,1LE PR: 1LB,1LE PR: 1LB,1LE PR: 1LB,1LE	11.3571-8522.2 11.3571-8521.2 11.0441-5704.2 11.0101-5409.2	220320 220319 250034 260035		+ ESP + ESP	D=57, - Halter D=57, - Halter Dichtungssatz Hülsensatz	ATE ATE ATE ATE
*		**					***		****		

*Product groups

	Booster unit		Brake drum
	Master cylinder		ATE Original Kit ATE Original TopKit
	Reservoir		Drum brake shoes for parking brake
	Brake caliper		Handbrake cable
	Disc brake pads		Brake pressure regulator
	Brake disc ATE PowerDisc		Clutch cylinder
	Brake hose		Kupplungs-Nehmerzylinder
	Wheel sensor		Clutch hose
	Wheel cylinder		Clutch cable
	Drum brake shoes		

**Hand drive

- ◀ Left hand drive
- ▶ Right hand drive

***Manufacturer

ATE	Continental Teves (ATE)
AKE	Akebono
AP	AP Lockheed
BDX	Bendix
BOS	Bosch
BRE	Brembo
CIT	Citroën
DEL	Delco
FI	Fiat
FTE	FTE Automotive
LUC	Lucas (TRW)
PER	Perrot
SUM	Sumitomo
TOK	Tokico
VW	Volkswagen

***Installation Position























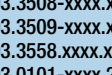

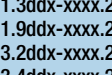

-
-
-
-
-
-
-
-
-
-
-
-
-
-
-
-
-

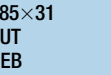
All position details are based on vehicle facing forwards

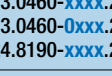
Abbreviations

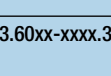
-	Without / not	L=	Length
+	With / only / for	Nz	Slave cylinder
AUT	Automatic adjustment	PD	PowerDisc
B	Coated	Rz	Wheel cylinder
BG	Brake force limiter	RzR	Wheel cylinder with built-in corrector
BR	Brake pressure regulator	S	Fixing screw / caliper screw
BRE	Screw-in regulator	THz	Tandem master cylinder
BRES	Screw-in regulator set	V	Ventilated
BRL	Brake pressure regulator, load sensitive	WE	Warning device
D=	Diameter	WK	Wear indicator
Gz	Clutch cylinder	Zub	Accessories
HEB	Lever		
HZ	Master cylinder		
L	Alloyed / highly carburized		

Parts information

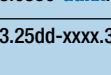
		SHORT NUMBER				SHORT NUMBER																			
		30nnnn	Brake booster T50 T51 T52/3 T52 T53 T52/4			24.02dd-dxxx.x → 48nnnn	Brake drums (e.g. 24.0223-0: Ø=230)																		
								03.6199-xxxx.4 →	230/231 × 47	Diameter / max. diameter × depth															
								03.61dy-xxxx.4 →	<table border="1"> <tr> <td>d</td> <td>y</td> </tr> <tr> <td>0 = 6"</td> <td>0 = Single unit</td> </tr> <tr> <td>2 = 7"</td> <td>3 = Single unit BA</td> </tr> <tr> <td>3 = 8"</td> <td>5 = Single unit</td> </tr> <tr> <td>4 = 9"</td> <td>8 = Single unit BA</td> </tr> <tr> <td>5 = 10"</td> <td>BA = Electronic brake actuator</td> </tr> <tr> <td></td> <td>Z = Tension bolt brake booster</td> </tr> </table>	d	y	0 = 6"	0 = Single unit	2 = 7"	3 = Single unit BA	3 = 8"	5 = Single unit	4 = 9"	8 = Single unit BA	5 = 10"	BA = Electronic brake actuator		Z = Tension bolt brake booster	▲ 03.27dd-xxxx.3 → 02nnnn	Single piston wheel cylinder
								d		y															
								0 = 6"		0 = Single unit															
								2 = 7"		3 = Single unit BA															
								3 = 8"		5 = Single unit															
								4 = 9"		8 = Single unit BA															
								5 = 10"	BA = Electronic brake actuator																
									Z = Tension bolt brake booster																
03.68dy-xxxx.4 →	▲ 03.32dd-xxxx.3 → 02nnnn	Wheel cylinder																							
03.69dy-xxxx.4 →	03.040x-xxdd.2 → 06nnnn	Repair kit (with pistons)																							
03.77dy-xxxx.4 →	03.0470-xxdd.2 → 06nnnn	Gasket kit (without pistons)																							
03.78dy-xxxx.4 →	03.0137-0xxx.2 → 650xxx 03.0137-9xxx.2 → 669xxx	Drum brake shoes Brake shoe accessories																							
03.78dy-xxxx.4 →			185 × 31 AUT HEB Zub	Diameter × width With automatic adjustment With lever With accessories																					
03.78dy-xxxx.4 →																									
03.78dy-xxxx.4 →																									
03.78dy-xxxx.4 →																									
03.20dd-xxxx.3 → 01nnnn	Step-bore tandem master cylinder		03.0420-xxdd.3 → 68xxdd 03.0520-xxdd.3 → 69xxdd	ATE original Kit ATE original TopKit (wheel cylinder + drum brake shoes + installation kit) dd = nominal dimension wheel cylinder																					
03.21dd-xxxx.3 → 01nnnn	Tandem master cylinder																								
03.23dd-xxxx.3 → 01nnnn	Step-bore master cylinder																								
03.31dd-xxxx.3 → 01nnnn	Master cylinder (e.g. 03.2122-: Ø=22,20)																								
03.0370-xxdd.2 → 05xxdd	Repair kit																								
		31nnnn	Reservoir			03.0137-0xxx.2 → 650xxx 03.0137-9xxx.2 → 669xxx	Parking brake (drum brake shoes) Installation kit																		
								03.3508-xxxx.x → 31nnnn	185 × 31 AUT HEB Zub	Diameter × width With automatic adjustment With lever With accessories															
								03.3509-xxxx.x → 31nnnn																	
								03.3558-xxxx.x → 31nnnn																	
03.0101-xxxx.2 → 39nnnn	Repair kit																								
		22nnnn	Fist-type caliper			24.3727-xxxx.2 → 58xxxx	Handbrake cable																		
								11.3ddx-xxxx.2 → 22nnnn	24.3727-xxxx.2 → 58xxxx																
								11.9ddx-xxxx.2 → 22nnnn																	
								13.2ddx-xxxx.2 → 21nnnn																	
								13.4ddx-xxxx.2 → 21nnnn																	
								13.9ddx-xxxx.2 → 21nnnn																	
								24.3ddx-xxxx.5 → 24nnnn																	
								11.0441-ddxx.2 → 25nnnn																	
								13.0441-ddxx.2 → 25nnnn																	
								11.0230-xxxx.2 → 26nnnn																	
24.0101-xxxx.2 → 26nnnn																									
11.0101-xxxx.2 → 26nnnn																									
11.8116-xxxx.1 → 39nnnn																									
		60xxxx	Disc brake pad			03.60xx-xxxx.3 → 32nnnn	Brake pressure regulator (BR) Brake force limiter (BG) Screw-in regulator (BRE)																		
								13.0460-xxxx.2 → 60xxxx	03.65xx-xxxx.3 → 32nnnn																
								13.0460-0xxx.2 → 610xxx																	
								24.8190-xxxx.2 → 62xxxx																	
								20034 15,0 + WE WK S Zub		03.0101-xxxx.2 → 32nnnn															
										35/3 braun (4)	Markings, coloured markings (number of connections)														
								Brake pads have homologation by German Federal Road Safty Department (ABE), or homologation according to regulation ECE-R 90 i.e. the brake pads are from the same production and subject to the same quality assurance procedures as the pad provided by the vehicle manufacturer.																	
											4dxxxx 5dxxxx	Brake disc ATE PowerDisc dd = thickness (e.g. 24.0322- : thickness = 22)			▲ 03.25dd-xxxx.3 → 04nnnn	Slave cylinder (e.g. 03.2525-: Ø=25,40) Gasket kit									
																	24.01dd-xxxx.x → 4dxxxx								
																	24.03dd-xxxx.x → 5dxxxx								
284 22 20 V L PD B V L S PD	24.3728-xxxx.2 → 59xxxx	Clutch cable																							
						24.07xx-xxxx.x → 36nnnn	Wheel sensor																		

nnnn = The last four digits correspond to a running number.

dd = Nominal dimension

▲ 24. also possible using same numbering system.

■ 03. and 24. also possible using same numbering system.

Complete copies or extracts of this catalog only by permission. Damage claims on the basis of data in this catalog cannot be recognized. The right of modification in construction or design is reserved. As far as we refer in our documents to part numbers of the vehicle makers, this is for comparison purposes only. The use of such information on invoices to the vehicle owner is not admissible.

The multitude of car models and spare parts from numerous vehicle manufacturers do not always allow an exact allocation. Therefore please pay attention to the corresponding remarks and spare part descriptions. Please therefore pay attention to the corresponding comments and spare parts descriptions.

Utilisation du catalogue C4

Groupes de produit		Type de véhicule	Date de montage (du/au)		Référence ATE	Remarque (référence)	
Essieu avant/arrière	No. de châssis (du/au)	Remarque (véhicule)	Référence Courte		Indication		
kW							
AUDI A4 CABRIO (02-)							
	1,8 T 1,8 T Quattro 2,0 2,0 TFSI	◀ 120 ◀ 120 ◀ 96 ◀ 120	8E-55-999999 8E-55-400001	04.02 05.03 08.06 08.06	PR: 1LB,1LE PR: 1LB,1LE PR: 1LB,1LE PR: 1LB,1LE	11.3571-8522.2 11.3571-8521.2 11.0441-5704.2 11.0101-5409.2	220320 220319 250034 260035
						☐ + ESP ☐ + ESP	D=57, - Halter D=57, - Halter Dichtungssatz Hülzensatz

*

**

*Groupes de produit

	Servo-frein		Tambour de frein
	Maître cylindre		Kit d'origine ATE TopKit d'origine ATE
	Réservoir		Mâchoires de frein à tambour pour frein à main
	Etrier de frein		Câble de frein à main
	Plaquettes de frein		Correcteur de freinage
	Disque de frein ATE PowerDisc		Emetteur d'embrayage
	Flexible de frein		Récepteur d'embrayage
	Capteur ABS		Flexible d'embrayage
	Cylindre de roue		Câble d'embrayage
	Mâchoires de frein à tambour		

**Direction

- ◀ Conduite à gauche
- ▶ Conduite à droite

****Fabricant

ATE	Continental Teves (ATE)
AKE	Akebono
AP	AP Lockheed
BDX	Bendix
BOS	Bosch
BRE	Brembo
CIT	Citroën
DEL	Delco
FI	Fiat
FTE	FTE Automotive
LUC	Lucas (TRW)
PER	Perrot
SUM	Sumitomo
TOK	Tokico
VW	Volkswagen

***Positionnement





















- ☐ avant
- ☐ arrière
- ☐ gauche
- ☐ droite
- ☐ avant gauche
- ☐ arrière gauche
- ☐ avant droite
- ☐ arrière droite
- ☐ milieu
- ☐ en haut
- ☐ en bas
- ☐ essieu avant
- ☐ essieu avant gauche
- ☐ essieu avant droite
- ☐ essieu arrière
- ☐ essieu arrière gauche
- ☐ essieu arrière droite

Toutes positions vues en position de conduite

Abréviations

-	Sauf / sans	L=	Longueur
+	Avec / seulement / pour	Nz	Récepteur d'embrayage
AUT	Ajustage Automatique	PD	PowerDisc
B	Revêtu	Rz	Cylindre de roue
BG	Limiteur de freinage	RzR	Cylindre de roue avec correcteur intégré
BR	Correcteur de freinage	S	Vis d'étrier / vis de fixation
BRE	Correcteur à visser	THz	Maître cylindre tandem
BRES	Jeu de correcteur à visser	V	Ventil
BRL	Correcteur de freinage asservi à la charge	WE	Dispositif d'avertissement
D=	Diamètre	WK	Témoin d'usure
Gz	Emetteur ,embrayage	Zub	Accessoires
HEB	Levier		
HZ	Maître cylindre		
L	Allié / carbonise		

Explications des références

		RÉF. COURTE																							
		03.6199-xxxx.4 → 30nnnn 03.61dy-xxxx.4 → 30nnnn 03.67dy-xxxx.4 → 30nnnn 03.68dy-xxxx.4 → 30nnnn 03.69dy-xxxx.4 → 30nnnn 03.77dy-xxxx.4 → 30nnnn 03.78dy-xxxx.4 → 30nnnn 03.78dy-xxxx.4 → 30nnnn 03.78dy-xxxx.4 → 30nnnn 03.78dy-xxxx.4 → 30nnnn 03.78dy-xxxx.4 → 30nnnn 03.78dy-xxxx.4 → 30nnnn	Servo-frein T50 T51 T52/3 T52 T53 T52/4 T52/4 T52/4Z T52/5 T52/5Z T55/1 T55/1Z	<table border="1"> <tr> <td>d</td> <td>y</td> </tr> <tr> <td>2 = 6"</td> <td>0 = Appareil simple</td> </tr> <tr> <td>3 = 7"</td> <td>5 = Appareil tandem</td> </tr> <tr> <td>4 = 8"</td> <td>0 = Appareil simple</td> </tr> <tr> <td>5 = 9"</td> <td>3 = Appareil simple BA</td> </tr> <tr> <td>6 = 10"</td> <td>5 = Appareil simple</td> </tr> <tr> <td></td> <td>8 = Appareil simple BA</td> </tr> <tr> <td></td> <td>BA = Assistance de freinage avec AFU</td> </tr> <tr> <td></td> <td>Z = Servo-frein à tirant</td> </tr> </table>	d	y	2 = 6"	0 = Appareil simple	3 = 7"	5 = Appareil tandem	4 = 8"	0 = Appareil simple	5 = 9"	3 = Appareil simple BA	6 = 10"	5 = Appareil simple		8 = Appareil simple BA		BA = Assistance de freinage avec AFU		Z = Servo-frein à tirant		24.02dd-dxxx.x → 48nnnn 230/231×47 03.27dd-xxxx.3 → 02nnnn 03.32dd-xxxx.3 → 02nnnn 03.040x-xxdd.2 → 06nnnn 03.0470-xxdd.2 → 06nnnn 03.0137-0xxx.2 → 650xxx 03.0137-9xxx.2 → 669xxx 185×31 AUT HEB Zub	Tambours de frein (p.ex. 24.0223-0: Ø=230) Diamètre / diamètre max. x largeur Cylindre de roue borgne Cylindre de roue Néc. de réparation (avec pistons) Jeu de joints (sans pistons) Mâchoires de frein à tambour Accessoires pour mâchoires de frein Diamètre x largeur avec ajustage automatique avec levier avec accessoires
					d	y																			
					2 = 6"	0 = Appareil simple																			
					3 = 7"	5 = Appareil tandem																			
					4 = 8"	0 = Appareil simple																			
					5 = 9"	3 = Appareil simple BA																			
					6 = 10"	5 = Appareil simple																			
						8 = Appareil simple BA																			
						BA = Assistance de freinage avec AFU																			
						Z = Servo-frein à tirant																			
	▲ 03.20dd-xxxx.3 → 01nnnn ▲ 03.21dd-xxxx.3 → 01nnnn ▲ 03.23dd-xxxx.3 → 01nnnn ▲ 03.31dd-xxxx.3 → 01nnnn 03.0370-xxdd.2 → 05xxdd	Maître cylindre tandem étagé Maître cylindre tandem Maître cylindre étagé Maître cylindre simple circuit (p.ex. 03.2122-: Ø=22,20) Néc. de réparation		03.0420-xxdd.3 → 68xxdd 03.0520-xxdd.3 → 69xxdd	Kit d'origine ATE TopKit d'origine ATE (cylindre de roue + mâchoires de frein à tambour + lot de montage) dd = dimension nominal cylindre de roue																				
							03.3508-xxxx.x → 31nnnn 03.3509-xxxx.x → 31nnnn 03.3558-xxxx.x → 31nnnn 03.0101-xxxx.2 → 39nnnn	Réservoir Réservoir Réservoir Néc. de réparation		03.0137-0xxx.2 → 650xxx 03.0137-9xxx.2 → 669xxx	Frein à main (mâchoires de frein à tambour) Lot de montage Diamètre x largeur avec ajustage automatique avec levier avec accessoires														
													▲ 11.3ddx-xxxx.2 → 22nnnn 11.9ddx-xxxx.2 → 22nnnn ▲ 13.2ddx-xxxx.2 → 21nnnn ▲ 13.4ddx-xxxx.2 → 21nnnn 13.9ddx-xxxx.2 → 21nnnn 24.3ddx-xxxx.5 → 24nnnn 11.0441-ddxx.2 → 25nnnn 13.0441-ddxx.2 → 25nnnn 11.0230-xxxx.2 → 26nnnn 24.0101-xxxx.2 → 26nnnn ▲ 11.0101-xxxx.2 → 26nnnn 11.8116-xxxx.1 → 39nnnn	Etrier à griffe Etrier à griffe Etrier à 2 pistons Etrier à 4 pistons Etrier fixe Etrier à griffe de réchange Jeu de joints Jeu de joints Jeu de supports d'étriers à griffe (support, jeu de douilles de guidage, boulon de guidage) Accessoires pour étriers de frein (jeu de douilles de guidage, boulon de guidage) Jeu de douilles de guidage Ressort à retenu		24.3727-xxxx.2 → 58xxxx 83.5yxx-LLLL.3 → 33nnnn 83.6yxx-LLLL.3 → 33nnnn 83.7yxx-LLLL.3 → 33nnnn y = 1: Raccordement 1x femelle/1x mâle y = 2: Raccordement 2x femelle y = 3: Raccordement 2x mâle	Câble de frein à main Flexible de frein-/d'embrayages Flexible de frein-/d'embrayages Flexible de frein-/d'embrayages								
																			13.0460-xxxx.2 → 60xxxx 13.0460-0xxx.2 → 610xxx 24.8190-xxxx.2 → 62xxxx 20034 15,0 + WE WK S Zub	Plaquette de frein Accessoires pour jeux de garnitures Témoin d'usure Code no. de WVA/épaisseur autres no. de WVA voir annexe Dispositif d'avertissement avec témoin d'usure avec vis d'étrier avec accessoires		03.60xx-xxxx.3 → 32nnnn 03.65xx-xxxx.3 → 32nnnn 03.0101-xxxx.2 → 32nnnn 35/3 braun (4)	Correcteur de freinage (BR) Limiteur de freinage (BG) Correcteur à visser (BRE) Correcteur de freinage asservi à la charge (BRL) Jeu de correcteur à visser (BRES) Indice, repère de couleur (nombre de raccords)		
	▲ 03.24dd-xxxx.3 → 03nnnn 03.0350-ddxx.2 → 07ddxx	Emetteur d'embrayage (p. ex. 03.2419-: Ø=19,05) Jeu de joints																							
				▲ 03.25dd-xxxx.3 → 04nnnn 03.0450-ddxx.2 → 08ddxx	Récepteur d'embrayage (e.g. 03.2525-: Ø=25,40) Jeu de joints																				
	24.3728-xxxx.2 → 59xxxx	Câble d'embrayage																							
				24.07xx-xxxx.x → 36nnnn	Capteur de roue																				

nnnn = Les quatre derniers chiffres correspondent à un ordre numérique.

dd = Dimension nominale

▲ Le préfixe de ces familles de produit peut également être 03. ou 24.

■ Le préfixe de ces familles de produit peut également être 03., 24. ou 83.

Toute reproduction totale ou partielle de ce catalogue est interdite sauf notre autorisation préalable. Une demande de dommages et intérêts qui se baserait ou aurait pour objet un renseignement donné par le présent catalogue ne saurait être retenue. Nous nous réservons le droit de modifier les spécifications de nos produits sans préavis et, si cela est nécessaire, pour assurer les performances optimales de nos gammes de produits. Les références constructeurs fournies dans le présent catalogue sont données seulement à titre indicatif. L'utilisation de telles informations dans les factures d'un détenteur de véhicule n'est pas admise.

La diversité des modèles et des pièces de rechange ne permet pas toujours une affectation correcte. Par conséquent nous vous prions de bien vouloir tenir compte des observations et des descriptions contenues dans ce catalogue.

Grupo de producto		Modelo	periodo de montaje (desde/hasta)		Referencias ATE		Indicaciones (repuesto)			
Eje delantero-/ trasero	Número de chasis (desde/hasta)	Indicaciones (vehículo)	Referencia corta	Información adicional						
kW										
AUDI A4 CABRIO (02-)										
	1,8 T	◀ 120	8E-55-99999	04.02	PR: 1LB,1LE	11.3571-8522.2	220320	+ ESP	D=57, - Halter	ATE
	1,8 T Quattro	◀ 120		05.03	08.06	PR: 1LB,1LE	11.3571-8521.2	220319		ATE
	2,0	◀ 96		05.04	08.06	PR: 1LB,1LE	11.0441-5704.2	250034		ATE
	2,0 TFSI	◀ 120	8E-55-40001		08.06	PR: 1LB,1LE	11.0101-5409.2	260035		Hülsensatz

*

**

*Grupo de producto

	Servofreno		Tambores de freno
	Cilindro maestro		ATE Original Kit ATE Original TopKit
	Depósito		Zapatas de freno para freno de estacionamiento (mano)
	Pinza de freno		Cable de freno de mano
	Pastillas		Corrector de frenado
	Disco de freno ATE PowerDisc		Cilindro transmisor de embrague
	Tubo flexible de freno		Cilindro receptor de embrague
	Sensor de rueda		Cables de embrague
	Cilindro de rueda		Cable de embrague
	Zapatas de freno		

**Dirección

- ◀ Volante a la izquierda
- ▶ Volante a la derecha

***Fabricante

ATE	Continental Teves (ATE)
AKE	Akebono
AP	AP Lockheed
BDX	Bendix
BOS	Bosch
BRE	Brembo
CIT	Citroën
DEL	Delco
FI	Fiat
FTE	FTE Automotive
LUC	Lucas (TRW)
PER	Perrot
SUM	Sumitomo
TOK	Tokico
VW	Volkswagen

***Posición de montaje























- adelante
- atrás
- izquierda
- derecha
- izquierda arriba
- izquierda abajo
- derecha arriba
- derecha abajo
- medio
- arriba
- abajo
- eje delantero
- izquierda adelante
- derecha adelante
- eje trasero
- izquierda atrás
- derecha atrás

Todas las indicaciones de posición se refieren siempre al sentido de la marcha.

Abreviaturas

-	Sin / no	L=	Largo
+	Con / solo / para	Nz	Cilindro receptor de embrague
AUT	Reajuste automático	PD	PowerDisc
B	Recubierto	Rz	Cilindro de rueda
BG	Limitador de frenado	RzR	Cilindro de rueda con regulador integrado
BR	Corrector de frenado	S	Tornillo para pinza / tornillo quierfija
BRE	Regulador de rosca	THz	Cilindro maestro tandem
BRES	Juego regulador de rosca	V	Ventilado
BRL	Corrector de frenado dependiente de carga	WE	Dispositivo de desgaste
D=	Diámetro	WK	Contactode desgaste
Gz	Cilindro transmisor de embrague	Zub	Accesorios
HEB	Palanca		
HZ	Cilindro maestro		
L	Aleación especial		

Información artículos

		NUEVA REFER.				NUEVA REFER.	
	03.6199-xxxx.4 → 03.61dy-xxxx.4 → 03.67dy-xxxx.4 → 03.68dy-xxxx.4 → 03.69dy-xxxx.4 → 03.77dy-xxxx.4 →	30nnnn 30nnnn 30nnnn 30nnnn 30nnnn 30nnnn	Refuerzo de la presión de frenada T50 T51 T52/3 T52 T53 T52/4		24.02dd-dxxx.x → 230/231×47	48nnnn	Tambores de freno (p. ej. 24.0223-0: Ø=230) Diámetro / diámetro max. x ancho
	03.78dy-xxxx.4 → 03.78dy-xxxx.4 → 03.78dy-xxxx.4 → 03.78dy-xxxx.4 → 03.78dy-xxxx.4 → 03.78dy-xxxx.4 →	30nnnn 30nnnn 30nnnn 30nnnn 30nnnn 30nnnn	T52/4 T52/4Z T52/5 T52/5Z T55/1 T55/1Z		▲ 03.27dd-xxxx.3 → ▲ 03.32dd-xxxx.3 → 03.040x-xxdd.2 → 03.0470-xxdd.2 →	02nnnn 02nnnn 06nnnn 06nnnn	Cilindro de rueda de un pistón Cilindro de rueda Juego de reparación (con pistón) Juego de reparación de juntas (sin pistón)
	03.3508-xxxx.x → 03.3509-xxxx.x → 03.3558-xxxx.x → 03.0101-xxxx.2 →	31nnnn 31nnnn 31nnnn 39nnnn	Depósito Depósito Depósito Juego de reparación		03.0137-0xxx.2 → 03.0137-9xxx.2 →	650xxx 669xxx	Zapatas de freno Accesorios para zapatas de freno Diámetro x ancho con reajuste automático con palanca con accesorios
	▲ 03.20dd-xxxx.3 → ▲ 03.21dd-xxxx.3 → ▲ 03.23dd-xxxx.3 → ▲ 03.31dd-xxxx.3 → 03.0370-xxdd.2 →	01nnnn 01nnnn 01nnnn 01nnnn 05xxdd	Cilindro maestro escalonado tándem Cilindro maestro tándem Cilindro escalonado maestro Cilindro maestro (p. ej. 03.2122-: Ø=22,20) Juego de reparación		03.0420-xxdd.3 → 03.0520-xxdd.3 →	68xxdd 69xxdd	Kit original ATE TopKit original ATE (juego de piezas de freno) (Cilindros de rueda + zapatas de freno + juego de montaje) dd = medida interior del cilindro de rueda
	03.3508-xxxx.x → 03.3509-xxxx.x → 03.3558-xxxx.x → 03.0101-xxxx.2 →	31nnnn 31nnnn 31nnnn 39nnnn	Depósito Depósito Depósito Juego de reparación		03.0137-0xxx.2 → 03.0137-9xxx.2 →	650xxx 669xxx	Freno de mano (zapatas de freno) Juego de montaje Diámetro x ancho con reajuste automático con palanca con accesorios
	▲ 11.3ddx-xxxx.2 → 11.9ddx-xxxx.2 → ▲ 13.2ddx-xxxx.2 → ▲ 13.4ddx-xxxx.2 → 13.9ddx-xxxx.2 → 24.3ddx-xxxx.5 → 11.0441-ddxx.2 → 13.0441-ddxx.2 → 11.0230-xxxx.2 → 24.0101-xxxx.2 → ▲ 11.0101-xxxx.2 → 11.8116-xxxx.1 →	22nnnn 22nnnn 21nnnn 21nnnn 21nnnn 24nnnn 25nnnn 25nnnn 26nnnn 26nnnn 26nnnn 39nnnn	Pinza de puño Pinza de puño Pinza fija 2-cilindros Pinza fija 4-cilindros Pinza fija Pinza de puño refabricada Juego de reparación de juntas Juego de reparación de juntas Juego de soportes de pinza de puño (soporte, juego de casquillos corredizos, perno de guía) Accesorios para pinza de freno (juego de casquillos corredizos, perno de guía) Juego casquillos corredizos Muelle de sujeción		24.3727-xxxx.2 →	58xxxx	Cable de freno mano
	▲ 83.5yxx-LLLL.3 → ▲ 83.6yxx-LLLL.3 → ▲ 83.7yxx-LLLL.3 →	33nnnn 33nnnn 33nnnn	Tubo flexible de freno-/embrague Tubo flexible de freno-/embrague Tubo flexible de freno-/embrague		83.5yxx-LLLL.3 → 83.6yxx-LLLL.3 → 83.7yxx-LLLL.3 →	33nnnn 33nnnn 33nnnn	Tubo flexible de freno-/embrague Tubo flexible de freno-/embrague Tubo flexible de freno-/embrague y = 1: Roscas 1× interior/1× exterior y = 2: Roscas 2× interior y = 3: Roscas 2× exterior
	13.0460-xxxx.2 → 13.0460-0xxx.2 → 24.8190-xxxx.2 → 20034 15,0 + WE WK S Zub	60xxxx 610xxx 62xxxx No. WVA/espesor para otros números WVA, véase suplemento Dispositivo de desgaste con contacto de desgaste con tornillo para pinza con accesorios	Pastilla de freno Accesorios para juego de pastillas Contacto de desgaste		03.60xx-xxxx.3 → 03.65xx-xxxx.3 → 03.0101-xxxx.2 → 35/3 marrón (4)	32nnnn 32nnnn 32nnnn	Corrector de frenado (BR) Limitador de frenado (BG) Regulador de rosca (BRE) Corrector de frenado dependiente de la carga (BRL) Juego de reguladores de rosca (BRES) Característica / marcación de color (número de conexiones)
Las pastillas de freno tienen un certificado general de aptitud técnica (abrev. alemana: ABE) o bien homologación según normativa ECE-R 90, es decir, proceden de la misma fabricación y están sujetas al mismo control de calidad que las de origen.							
	24.01dd-xxxx.x → 24.03dd-xxxx.x → 284 22 20 V L PD B V L S PD	4ddxxx 5ddxxx Diámetro / espesor / grosor mínimo Recubierta ventilado aleación especial Tornillo para pinza ATE PowerDisc	Disco de freno ATE PowerDisc dd = espesor (p.ex. 24.0322 : espesor = 22)		▲ 03.24dd-xxxx.3 → 03.0350-ddxx.2 → ▲ 03.25dd-xxxx.3 → 03.0450-ddxx.2 → 24.3728-xxxx.2 → 24.07xx-xxxx.x →	03nnnn 07ddxx 04nnnn 08ddxx 59xxxx 36nnnn	Cilindro transmisor de embrague (p.ej. 03.2419-: Ø=19,05) Juego de reparación de juntas Cilindro receptor de embrague (e.ej. 03.2525-: Ø=25,40) Juego de reparación de juntas Cable de embrague Sensor de rueda

nnnn = Las cuatro últimas cifras son números correlativos.

dd = Medida nominal

▲ También posible el 24. en caso del mismo sistema de numeración.

■ También posible el 03. y 24. en caso del mismo sistema de numeración de numeración.

Sólo se permite la reproducción total o parcial con nuestra autorización. No se atenderán reclamaciones motivadas por los datos contenidos en este catálogo. Quedan reservados los derechos de modificaciones en la construcción. Si en nuestros documentos hacemos referencia a números de piezas de recambio de los constructores de vehículos, esto únicamente es para establecer una comparación. No está permitido el uso de datos de este tipo en las facturas emitidas al propietario del vehículo.

La variedad de modelos y de piezas de recambio de algunos constructores de vehículos no permite siempre una distribución exacta. Por este motivo, por favor fíjese atentamente en las observaciones y descripciones de las piezas de recambio detalladas en el catálogo.

ATE Classic Anfrage



Datum : *

Continental Aftermarket GmbH
 Guerickestraße 7
 60488 Frankfurt a. M.

www.ate-classic.de

Kontaktdaten :

Firma :

Name : *

Vorname :

Straße und Nr : *

PLZ : *

Ort : *

Land : *

E-Mail :

Telefon : *

Telefax :

Fahrzeugdaten :

Marke - Modell :

Typ :

Hubraum cc :

Kraftstoff :

Baujahr :

Leistung : PS KW

KBA Zu 2 : Zu 3 :

Lenkungsseite :

Produktdaten:

	Artikel 1	Artikel 2	Artikel 3	Artikel 4
Produktbezeichnung : *				
ATE-Nummer :				
sonstige Referenz Nr.:				
Einbauseite :				
Einbauposition :				
Menge : *				
Bemerkung :				

Ihre Nachricht an uns:

* Pflichtfelder
 Um Rückfragen zu vermeiden, füllen Sie bitte möglichst alle Felder aus.



ATE Classic Request



Date : *

Continental Aftermarket GmbH
Guerickestraße 7
60488 Frankfurt a. M.
Germany

www.ate-classic.de

Contact data :

Company :

Surname : *

First name :

Street and No. : *

Post (Zip) Code : *

City : *

Country : *

E-Mail :

Telephone : *

Telefax :

Vehicle data :

Make - Model :

Type :

Engine displ. cc :

Fuel :

Year :

Performance HP KW

Steering side :

Product data:

	Article 1	Article 2	Article 3	Article 4
Productname : *				
ATE-Number :				
Other reference No.				
Install. Pos. left- right :				
Install. Pos. front-rear :				
Quantity : *				
Comment :				

Your message to us :

* Mandatory fields
To avoid callbacks, please fill all possible fields.





A large rectangular area containing 30 horizontal lines, intended for writing or drawing.



A large rectangular area containing 30 horizontal lines, intended for writing or drawing.



A large rectangular area containing 30 horizontal lines, intended for writing or drawing.



A large rectangular area containing 30 horizontal lines, intended for writing or drawing.



A large rectangular area containing 30 horizontal lines, intended for writing or drawing.

ATE – A Trademark of the Continental Corporation

Continental Aftermarket GmbH

Guerickestraße 7 · D-60488 Frankfurt am Main · Germany
Tel. +49 (0) 69 7603-1 · Fax +49 (0) 69 761061

Continental Automotive Trading Italia Srl

Aftermarket ATE
Via Matteotti, 62 · I-20092 Cinisello Balsamo MI
Tel. +39 02 35680 388 · Fax +39 02 35680 325
www.ate-freni.it

Continental Automotive France SAS Département Rechange Indépendante

Aftermarket
Parc Ariane, Bâtiment Vénus
Rue Hélène Boucher · F-78280 Guyancourt
Tél. +33 (0)1 39 44 10 30 · Fax +33 (0)1 39 44 10 40
www.ate-freinage.fr

Continental Automotive Spain, S.A.

Aftermarket ATE
C/ Sepúlveda, 11 · E-28108 Alcobendas (Madrid)
Phone +34 (0)91 126 6934 · Fax +34 (0)91 657 2149
www.frenos-ate.es



www.ate.de
www.ate-classic.de

